



## User Guide

# Table of Contents

<b>Part I Getting Started</b>	<b>1</b>
1 Connecting the Beamz controller .....	1
2 Checking for software updates .....	2
<b>Part II Beamz software and hardware details</b>	<b>2</b>
1 Beamz Overview .....	2
2 Hardware .....	3
Beamz controller overview .....	3
Beamz controller base details .....	4
3 Software .....	6
Your first performance .....	6
Beamz player overview .....	10
Songs and Playlists .....	12
Video Player window .....	16
Tools Menu .....	16
Help Menu .....	23
More Songs .....	23
<b>Part III Getting the most out of your Beamz</b>	<b>24</b>
1 Overview .....	24
2 Optimizing your Beamz setup .....	24
3 Beamz trigger types .....	26
4 Working with Beamz loop songs .....	28
5 Learning a Beamz song .....	29
6 Recording a performance .....	30
7 Swap and Hold .....	31
8 Adjusting a song's tempo .....	31
<b>Part IV Beamz product support</b>	<b>32</b>
<b>Part V Software License Agreement</b>	<b>33</b>
<b>Part VI Song License Agreement</b>	<b>38</b>
<b>Part VII Legal and safety notices</b>	<b>43</b>
<b>Part VIII Trademarks and warranty information</b>	<b>48</b>

## Connecting the Beamz Controller

[Top](#) [Previous](#) [Next](#) 

Begin by assembling your Beamz controller. You'll want to set the Beamz base unit on a *flat, stable, level* surface. Unfold the Beamz controller arms and insert them securely into the Beamz base. Connect the Beamz controller to any available USB port on your PC.

 You must connect the Beamz controller to a dedicated USB port on your computer and *not* a USB hub.

 Make sure that there are no cables or other obstructions underneath either of the Beamz unit arms. Such obstructions can cause the Beamz unit to act unpredictably.

The Beamz USB port is located on the right hand side of the Beamz controller's base:

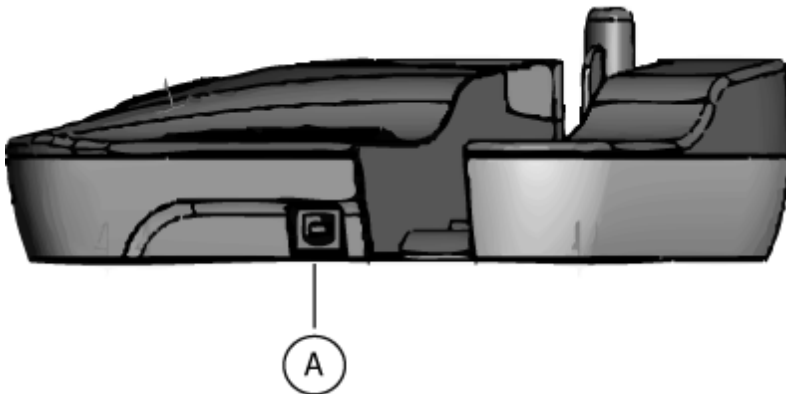

A. Beamz USB port.

 The USB port on the Beamz base unit is actually inverted with the rounded edges pointing down instead of up.

Your Beamz system is now configured and ready to use. You can now continue to [Your first performance](#) .

[Top](#) [Previous](#) [Next](#) 

## Checking for software updates

Top [Previous](#)<sup>[1]</sup> [Next](#)<sup>[2]</sup>

From time to time, we'll release new software updates to add features or improve performance. You can check for new versions of the Beamz software by visiting <http://www.thebeamz.com/> and clicking on the Support tab.

## Beamz Overview

Top [Previous](#)<sup>[2]</sup> [Next](#)<sup>[3]</sup>

The Beamz system comprises three main components: the "*body*," which is the hardware assembly containing the lasers and control buttons, the Beamz player software which controls the hardware and provides the product's "*mind*," and, finally, the individual songs themselves which collect instruments and backing melodies together in individual packages and provide the system's "*soul*."

For complete details on the Beamz system, please see:

- [Beamz controller overview](#)<sup>[3]</sup>
- [The Beamz player overview](#)<sup>[10]</sup>

## Beamz controller overview

Top [Previous](#) <sup>2</sup> [Next](#) <sup>4</sup>

The Beamz controller comprises six class 2 pulsing laser triggers, four control buttons and one rotary volume control. The lasers have been carefully chosen to balance power requirements and reliability, while the pulsing operation insures minimal interference from ambient light. The Beamz laser arms fit securely into the control base without the need for fasteners and the plastic body is lightweight and impact resistant. The following figure shows the Beamz controller assembled and ready to play:

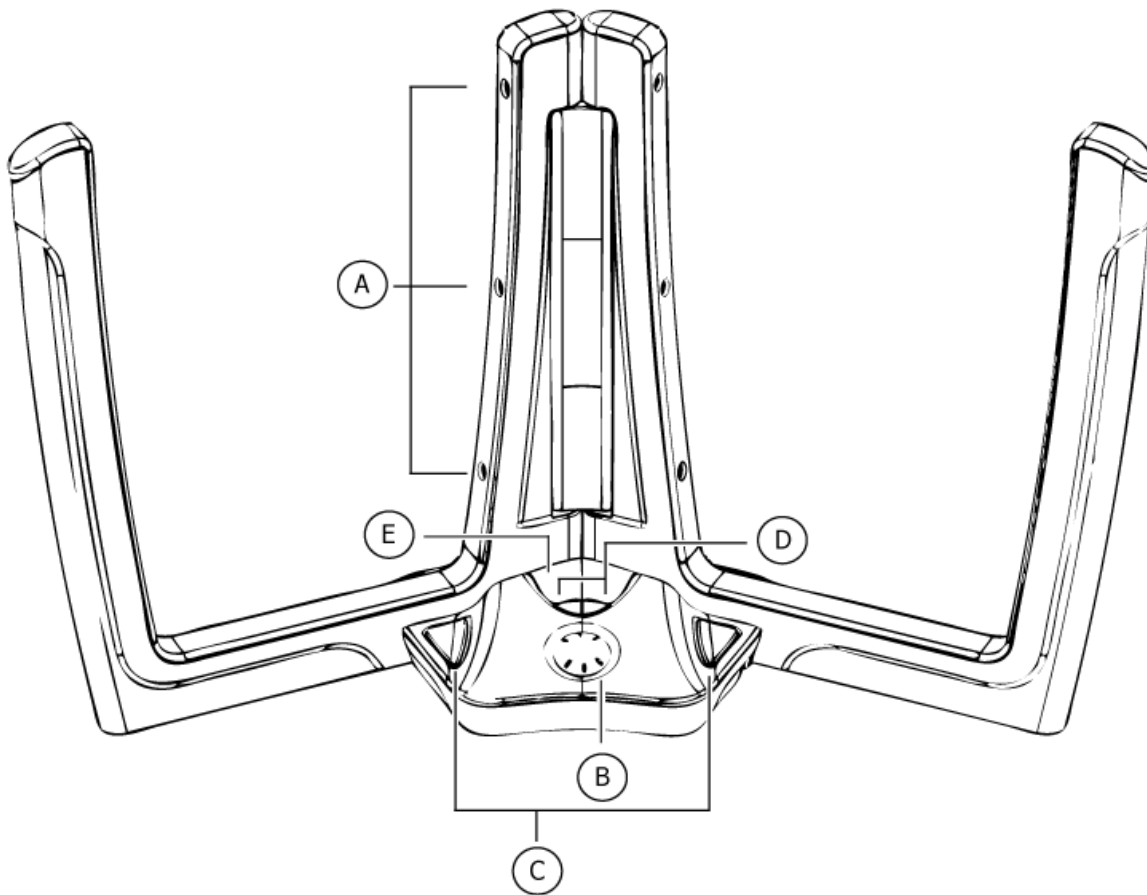

**A.** Control lasers (three to a side). **B.** Rotary volume control. **C.** Large control buttons, left (swaps sounds) and right (rhythm start/stop). **D.** Small playlist control buttons, left (previous song) and right (next song). **E.** LED song number indicator.

When the controller is connected to a PC and the Beamz software is running, you can break the laser beams to trigger a particular instrument. You also have access to additional Beamz controls.

Top [Previous](#) <sup>2</sup> [Next](#) <sup>4</sup>

## Beamz controller base details

Top [Previous](#) [3](#) [Next](#) [6](#)

The following figure is a top-down view of the Beamz control base without the laser arms installed:

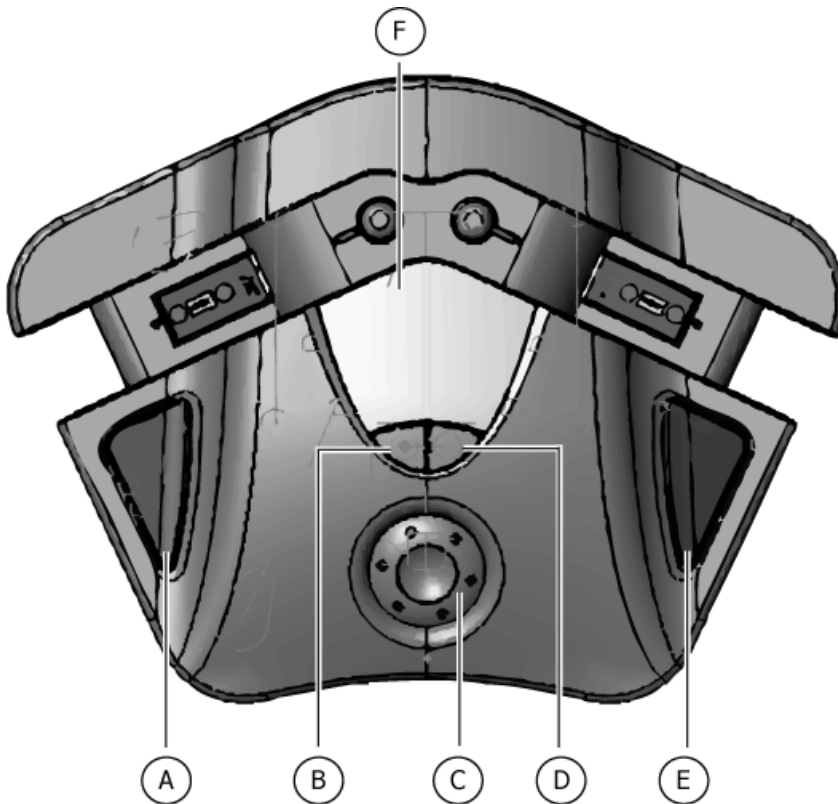

You can control the following software functions using the additional hardware buttons on the Beamz control base:

- A. The left large control button is configurable but defaults to switching the current bank of instruments controlled by the beams.
- B. The left small playlist control button will move to the "previous" song in a playlist. If a playlist is not selected, this button will have no effect.
- C. The rotary volume control lets you modulate the master volume of the Beamz song.
- D. The right small playlist control button will move to the "next" song in a playlist. If a playlist is not selected, this button will have no effect.
- E. The right large button is configurable, but defaults to starting and stopping the currently loaded song.
- F. LED song number indicator.

Beyond the base control buttons, the only other port on the Beamz control unit is the USB port:

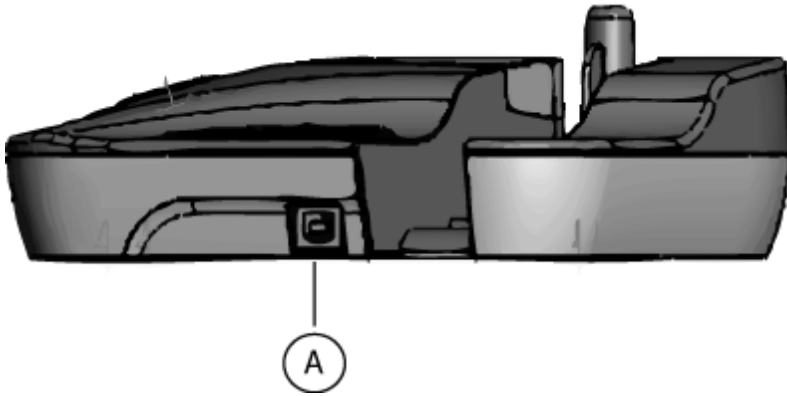

A. *Beamz controller USB port.*

 The Beamz controller USB port is inverted.

Top [Previous](#) <sup>3</sup> [Next](#) <sup>6</sup>

## Your first performance

Top [Previous](#) <sup>4</sup> [Next](#) <sup>10</sup>

Once you've got the Beamz software and music installed, and the Beamz controller is connected to your computer, you're ready to play.

### Contents

- [Load a song](#) <sup>7</sup>
- [Play a song](#) <sup>7</sup>
- [Next steps](#) <sup>9</sup>

## Set up your Beamz controller

Place the Beamz control unit on a *flat, level, stable* surface. Unfold the Beamz laser arms and insert them firmly but *gently* into the Beamz control unit base. Connect the Beamz control unit to any available USB port on your PC. Make sure your PC has built-in speakers, is connected to a pair of speakers or you've got headphones plugged into a headphone jack.

## Launch the Beamz player

Double-click the Beamz player icon  on your Windows desktop, or click the Start menu, choose All Programs and find the Beamz program group and click the Beamz icon.

The Beamz player will appear:





## Load a song

Next, click the  button. A popup menu will appear:

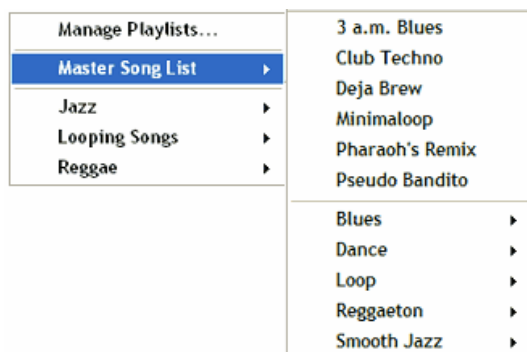

You can choose any of the installed songs from the Master Song List menu. For a first-timer, we recommend **Pharaoh's Remix** or **Beatnik Blues**.

## Play a song

Once the song loads, the Beamz player will switch to its ready-to-play mode:



Click the large right button on the Beamz controller base and the rhythm accompaniment will begin. Go ahead and experiment with the Beamz controller by breaking the laser paths with your hands. When you block a beam, the beam color switches from red to green in the software interface.

You'll notice that the notes are timed to the beat of the rhythm accompaniment and that as you trigger each one, an appropriate musical sequence of notes is played depending upon the rhythm accompaniment's current key. In short, you're performing much like a music conductor: you're calling upon each instrument and controlling the *shape* of the music, but the Beamz software is taking care of making sure everything *fits* together seamlessly.

 While it should go without saying, *seriously*, do **NOT** stare directly into the Beamz control unit lasers.

### Quick tips

- Experiment with blocking a beam continually as well as blocking a beam in rapid succession to trigger individual notes.
- Experiment with a single beam at a time to see how it behaves and then move to the next beam.
- Note that breaking multiple beams in rapid succession can get noisy. Less is usually more.

## Next steps

Once you're ready to learn more, please see the [Playing the Beamz](#)<sup>[24]</sup> for in-depth details on controls and techniques. If you'd like to read all about the various software controls and system knobs and switches, see [Hardware and software details](#)<sup>[2]</sup>.

Top [Previous](#)<sup>[4]</sup> [Next](#)<sup>[10]</sup>

# Beamz player overview

The Beamz software interface is the mind of the Beamz music system. The interface mimics the actual physical interface of the Beamz music controller and lets you choose different songs, manage playlists of songs, and customize song configurations.

**Song Position Display**  
*Bars:* Beats into the current Section.  
*Name:* of the current Song Section.  
*Bars:* Beats since the song started.

**Song Name and number of its position on the Playlist.\***

**Playlist Up / Down.**  
 Click the arrows to move up/down the Playlist.\*  
 Playlist.\*  
 Master Song List or User created Playlist.

**Play Tempo**  
 Displays speed in Beats per Min.  
 Click the arrows to increase or decrease the tempo speed.  
 Click *Reset* to restore to original tempo.

**Beams**  
 Mouse-Over any beam to play it. Beams turn green when they are playing.

**Unit Number**  
 Click to Swap beamz units. (same as *Swap Sounds*)

**Swap Sounds**  
 Click to Swap beamz units. (*Unit Number* will change)

Click to **Record** a beamz performance.

Click to **Save** the current recording.

**Rhythm**  
 Click to Start or Stop the song.

Click to **Play** the current recording.

**Master Volume**  
 Drag the slider up and down.

**Power Button**  
 Click to turn beams On / Off.

**Songs and Play-Lists menu.**

**Options and settings menu.**

**Help Menu.**

**Buy songs at Beamz web.**

The control areas are as follows:

- A. The upper control area shows the currently playing song, the song position indicator, (if shown) as well as controls to select the next or previous song in the current playlist, and adjust the current song's tempo.
- B. The left hand control area contains five control buttons, **Playlists** for playlist and song management, **Tools** for Beamz customization and configuration settings, a **Help** button to display help, a volume control, a power button which enables the Beamz application to play music, and a **More Songs** button which will take you to <http://www.thebeamz.com> to purchase more music for your Beamz system.

- C. A graphical representation of the Beamz control unit including the six laser triggers, a  button to switch instrument banks for the current song, two configurable buttons (the large outside buttons on the control unit) and a small strip of controls to record, play/pause a recorded song and save a song you've been recording. The beams rendered in the graphic are red when unbroken and green when broken.

## Song Position Display

Details on the current song position are displayed below the song title:

### Pharaoh's Remix

9:1	INTRO A	9:1
-----	---------	-----

In the center of the display is the name of particular section of the song that's playing. Song names can be anything from simple letters denoting the particular section's musical key (A, B, C, D, etc.) or a brief label (as in INTRO A above). In the first cell, you've got the current measure of the current section followed by current beat in that section. In the third cell, you've got the cumulative number of measures in the entire song, followed by the current beat.

## A three step how to

When you want to play a song or a group of songs, you'll follow the same three step procedure:

1. Load the song or playlist using the  button.
2. Press the large right control button on the Beamz controller , or click the large right control button on the graphic in the software interface.
3. Block the laser beams to activate the various instruments. Note that you can also trigger the instruments with your mouse pointer.

Top [Previous](#)  [Next](#) 

## Songs and Playlists

Top [Previous](#) [Next](#)

The  button will let you choose a song to play, a playlist to play, or will let you create a new playlist or manage existing playlists.

### Choosing a song

To choose a song, click the  button, and select **Master Song List** or **Playlist** from the popup menu. The Master song list displays all Beamz songs currently installed on your machine, sorted alphabetically. At the bottom of the Master Song List, songs are also sorted into their appropriate genres. Simply click the song you wish to play and it will be loaded into memory. The LED song number display will cycle as the song loads.

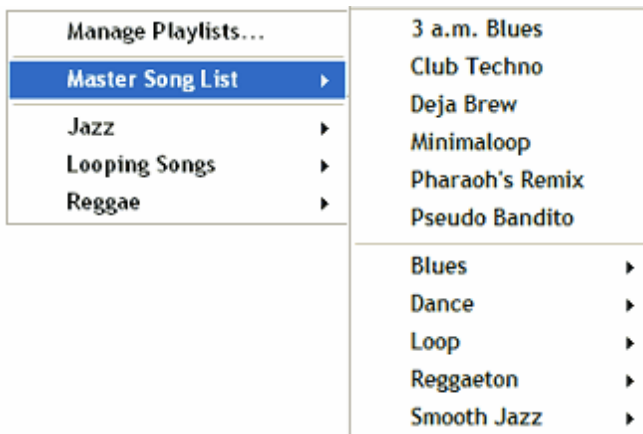

### Choosing a playlist

If you have created playlists, they will be listed at the bottom of the  popup menu. Click on the playlist you'd like to play and it will be loaded into memory. The LED song number display will cycle as the playlist loads. You can also select a specific song within a playlist.

### Creating a playlist

To create, edit, or delete playlists, click the **Playlists** button and choose the **Manage Playlists** command from the popup menu to display the Manage Playlists dialog:

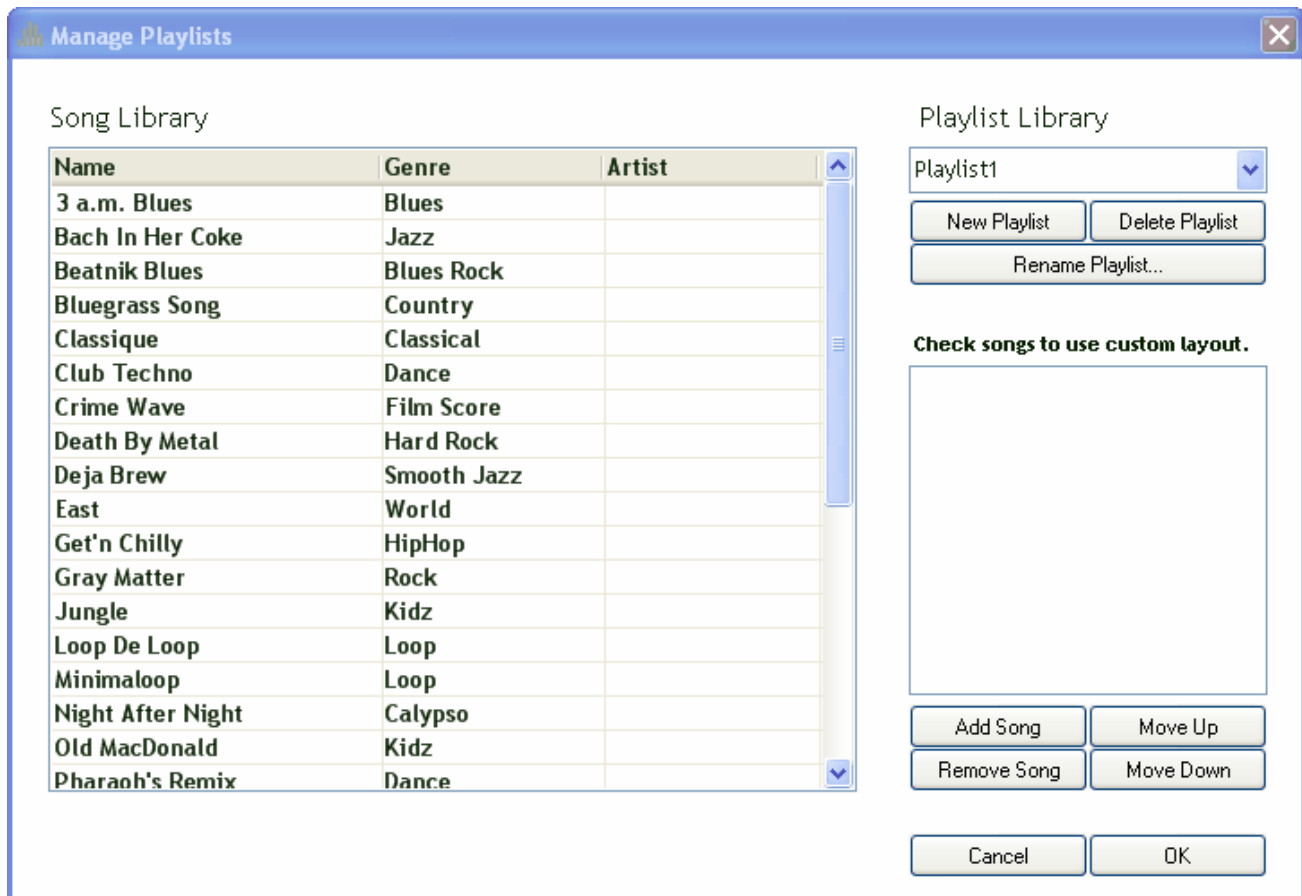

On the left side of the dialog, you'll see all of your currently installed songs listed under **Song Library**. You can click the headings at the top of the Song Library to sort by **Name**, **Genre**, or **Artist**. On the right side of the dialog, you'll see the controls for creating, managing and deleting playlists.

### To create a new Playlist

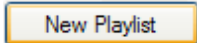
1. When you open the dialog, if you have not configured any playlists, by default, an empty playlist, imaginatively named Playlist with a number appended (Playlist1, Playlist2, etc.) is created. You can rename the playlist by selecting and typing over the default existing name, located at the upper right of the dialog under the Playlist Library label. If you have created playlists, the last playlist you loaded will be selected by default.
2. If an existing playlist is loaded, click the  and enter a name for it in the playlist name edit box.
3. Select the songs you'd like to add to the new playlist in the Song Library on the left. You can add a song to the playlist in the following ways:
  - 3a. You can double-click a song to add it to the playlist queue.
  - 3b. You can drag a song from the song list to the playlist queue.

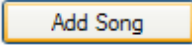
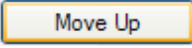
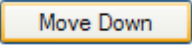
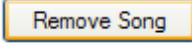
- 3c. You can select a song from the song list and click the  button.
4. Once you're satisfied with the song list, you can fine tune the order of songs using the  and  buttons at the lower right of the dialog. You can also remove songs by selecting them and clicking the  button.
5. Click the OK button to save the playlist or Cancel to abandon the playlist.

### To delete an existing Playlist

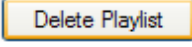
1. Select the Playlist you want to delete from the drop down combo box below the Playlist Library label in the upper right of the Create Playlists dialog.
2. Click the  button. You'll be asked if you really want to delete the playlist in question. If you click Yes, the playlist will be gone forever. If you click No, the playlist will live to rock another day.

### To edit an existing Playlist

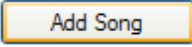
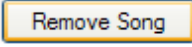
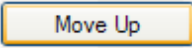
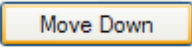
1. Select the Playlist you want to edit from the drop down combo box below the Playlist Library label in the upper right of the Create Playlists dialog.
2. The songs included in the playlist are queued in the list box below the New Playlist/Delete Playlist buttons. You can add songs by either double-clicking them in the Song Library listing or selecting multiple songs and using the  button. You can delete songs by selecting them and clicking the  button, and you can rearrange songs by selecting the song you want to move and clicking either the  or  button to reposition it in the playlist.
3. Click the OK button to save your changes to the playlist or the Cancel button to abandon your changes.

### To rename an existing Playlist

1. Select the Playlist you want to rename from the drop down combo box below the Playlist Library label in the upper right of the Create Playlists dialog.
2. Click the  button. Enter the new Playlist name in the dialog box that appears and click OK.

## Navigating through a playlist

After you've selected a playlist, you'll notice the first song in the playlist is loaded and has a number preceding its title indicating its position in the playlist:



## 01 3 AM Blues



In addition, you'll notice that the previous/next buttons, , adjacent the title are enabled. You can advance to the next song by clicking the button and you can move to the previous song by clicking the bottom button. The easiest way to navigate through a playlist, however, is by using the small playlist control buttons on the Beamz controller's base:

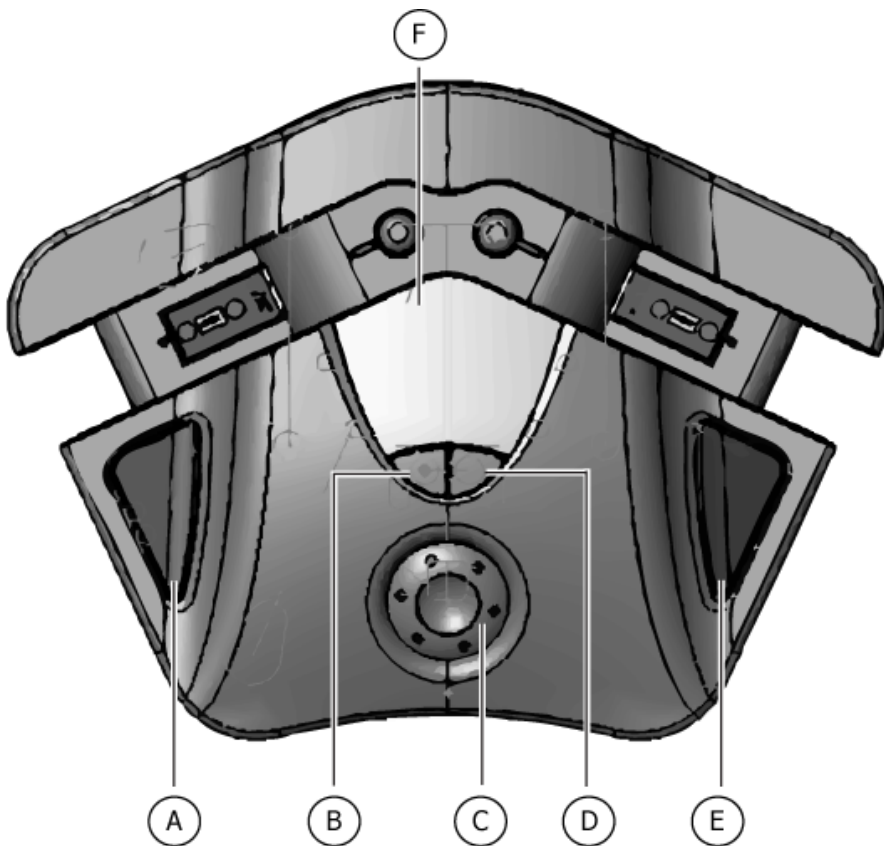

The LED display, F, indicates the song number of the current song in the playlist. The left small playlist control button, B, moves to the previous song in the playlist, while the right small playlist control button, D, moves to the next song in the playlist.

## Video Player window

Top [Previous](#)<sup>[12]</sup> [Next](#)<sup>[16]</sup>

When a Beamz Video Jam (vJam) song is loaded, a window will open for the video player.

The video window can be resized and dragged anywhere.

Click inside the video to expand it to full screen.

Click again to exit full screen view.

## Tools Menu

Top [Previous](#)<sup>[16]</sup> [Next](#)<sup>[23]</sup>

When you click the  button, the following menu is displayed:



The commands available in the Tools menu let you customize the behavior of the Beamz controller and configure certain aspects of the Beamz software interface. The Tools menu commands are described in the following sections.

### Tools button: Custom Beam Layout

While the Custom Beam Layout screen looks daunting at first, it's really quite simple. Using this screen, you can rearrange which beam corresponds to which instrument. You can also control the volume of each instrument and you can control the behavior of the two main buttons on the base of the unit.

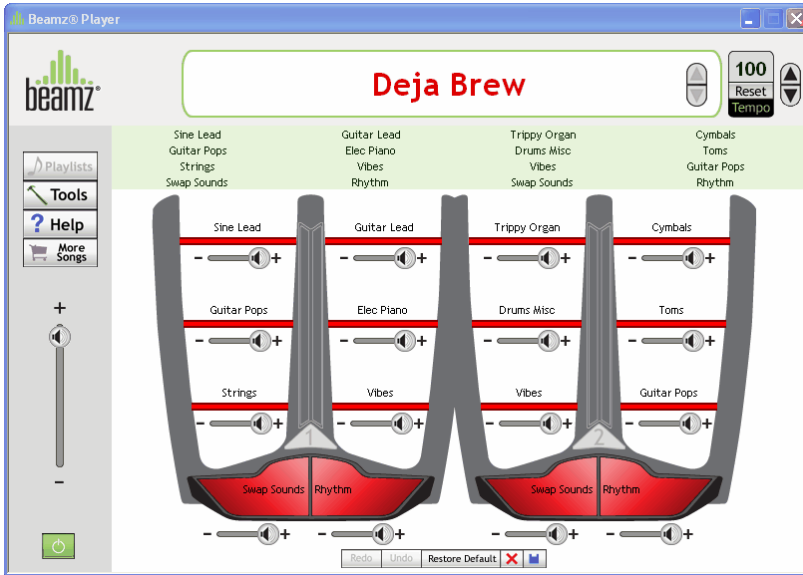

You'll notice that there are two Beamz units rendered side by side. The two controllers don't indicate that you have two separate hardware units installed; rather, they indicate that each Beamz laser can trigger two separate instruments depending upon which "bank" of instruments is currently loaded. In the standard player mode, the bank switch, , tells you which set of instruments is currently loaded. You can switch between the banks by clicking the bank switch button or by pressing the large left hardware

button on the Beamz controller base, .

### Changing a beam's assigned instrument or a Beamz controller button behavior

To change a beam's assigned instrument, click on any of the available instruments in the instrument palette located above the beams graphics:

Sine Lead	Guitar Lead	Trippy Organ	Cymbals
Guitar Pops	Elec Piano	Drums Misc	Toms
Strings	Vibes	Vibes	Guitar Pops
Swap Sounds	Rhythm	Swap Sounds	Rhythm

You can then drag and drop the instrument on the beam or button you'd like to trigger it, and it will replace the current instrument. You can also drag instruments from one beam to another. Note that there are two specialized trigger, **Swap Sounds**, and **Rhythm** that are usually assigned to the left and right Beamz controller keys respectively.

 Be aware that if you drag and drop an instrument onto the large left or right control buttons, you'll lose the ability to switch between instrument banks or start and stop the rhythm accompaniment. You can always drag **Swap Sounds** or

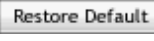
Rhythm back to the buttons or click the  button.

You'll notice after you've changed a beam's assignment, that the title of the song turns from black:

**Deja Brew**

to red:

**Deja Brew**

in order to indicate that the song has been customized. The song title will appear red in playlists, the playlist management dialog and the master song list as well.

### Controlling an individual beam's instrument's volume

You'll notice that each of the beams in both banks has its own volume control:



The volume controls let you determine whether a solo instrument such as a saxophone or guitar should play louder than a background instrument such as bass or a drum flourish. To adjust the volume of a particular beam, simply click and slide its volume control left to reduce its volume and right to increase its volume.



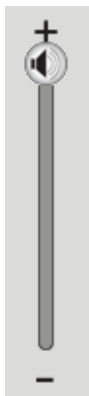

### Controlling a song's master volume

You can also adjust the master volume of a song by clicking and dragging the master volume slider on the left of the player window:



The volume you've selected will be saved along with any other customizations.

## Managing your custom layout

If you change your mind, you can click the  button to undo the change, or the  button if you decide the change was actually what you wanted. You can also click the  button to return the song to its original settings. Clicking the  button will save the changes you've made to the assignments, and clicking the  button will discard your changes and return you to the Beamz player mode.

## Tools button: Manage Playlists

Manage Playlists takes you to the Manage Playlists dialog as described in [Playlists](#)<sup>[12]</sup>.

## Tools button: Use Custom Preset

If the current song has been customized using the [Custom Beam Layout](#)<sup>[16]</sup> function, the Use Custom Preset menu item will be checked. You can quickly toggle between a songs customized format and its default format using this menu item. If you have not saved customized changes for the current song, then this menu item will be greyed out and unavailable.

## Tools button: Options

Clicking the Options menu command brings up the following dialog:

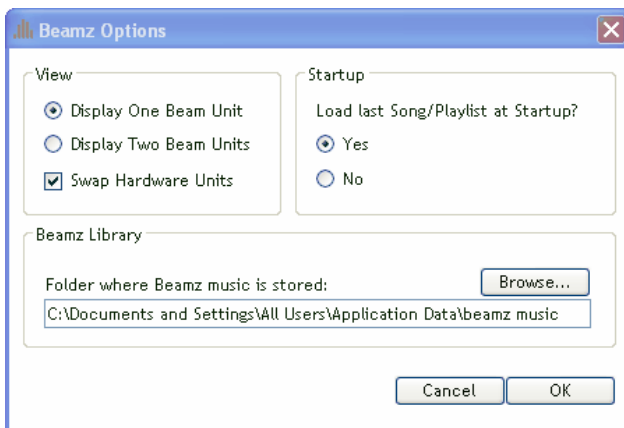

In the **View** group, you have the following options:

**Display One Beam Unit:** Default--shows a single beam unit in the player interface

**Display Two Beam Units:** Shows two beam units side by side in the player interface with

all of the instruments for each bank:



**Swap Hardware Units:** If you have two beam units connected to your PC, you can select this command to switch which unit functions as the left unit and which one functions as the right unit.

In the **Startup** group, you have the option to either load the last song played or no song when the Beamz interface is launched.

**BEAMZ LIBRARY** lets you select the location of your Beamz song music files.

Use the **Browse...** button to point to the folder containing your Beamz song music files. The default location is a "shared" folder in the Windows operating system so that a computer shared by multiple people with separate user profiles will all have access to the Beamz song music folder.

**IMPORTANT NOTE** - if you chose to move your Beamz song library to another location, take note that as you purchase additional songs and install them you will need to direct the installer to place the song to the folder location you specified in Options.

## Tools button: Map Beamz to Keystrokes

The Beamz controller can be used in place of your computer's keyboard to trigger keystrokes.

The default setting for the Beamz Player and Beamz Studio software is only set for Beam 7 to trigger the space-bar on your computer. This is the default setting so that the Beamz Player or Beamz Studio software is ready to communicate with your computer keyboard to advance slides and graphics included with Beamz Music Education Songs

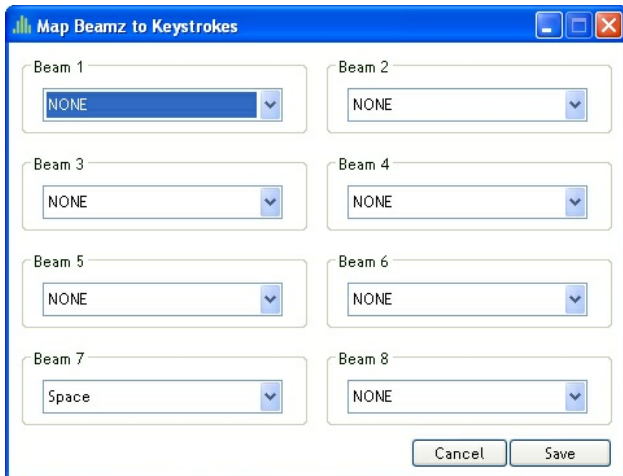

### Important Note:

If you change the settings to play games, you must change the settings back to the default as illustrated above in order for the Beamz Music Education Song titles to function properly.

## Mapping Beams To Keystrokes for a game.

The Beamz controller can be used in place of your computer's keyboard to play games and optionally hear a Beamz song while you play the game.

**NOTE:** The keystrokes you assign to beams must match the keystrokes used to control the game you want to play.

1. Launch the game you intend to play.
2. Launch the Beamz software.
3. Use Map Beams to Keystrokes in the Tools Menu to set the keystroke you want each beam to generate.
4. Switch back to the game window and play the game with the Beamz lasers.

Here's an example of how to map the beams to play the Pinball game that is included with Windows XP.

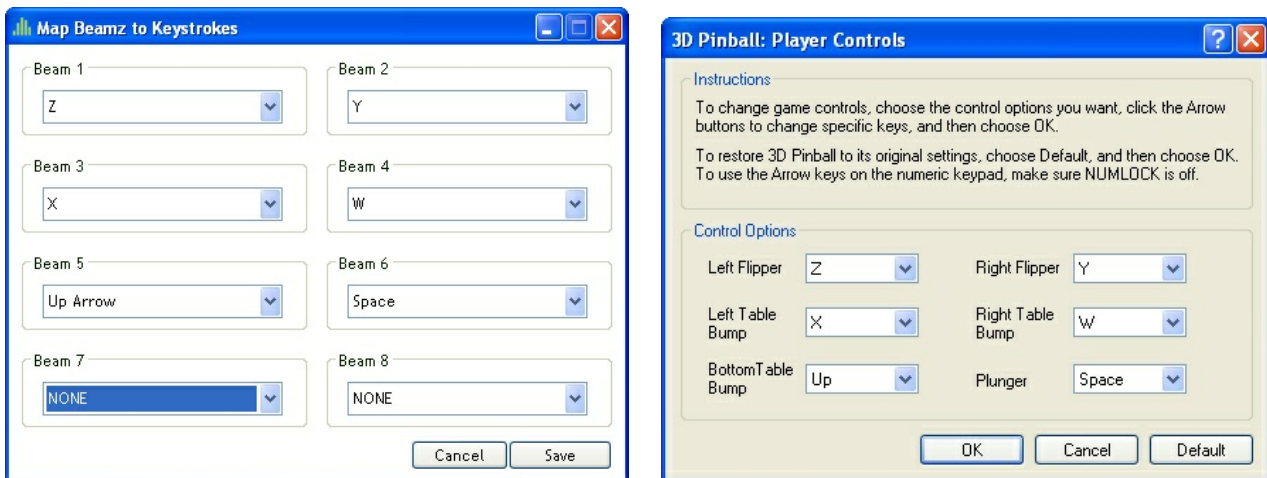

(A good Beamz song for this game is Death By Metal in the Beamz Master Song List.)

## Notes on Game sounds.

To hear only the sounds made by the game, turn the volume all the way down on the Beamz screen.

To hear only the Beamz song, use the player controls/options in the game to turn off its sounds.



## Help Menu

Top [Previous](#)<sup>[16]</sup> [Next](#)<sup>[23]</sup>

The  button displays the Beamz help menu.

### Help button: User Guide

Clicking User Guide opens the Beamz Player Help files.

### Help button: Register Beamz

Clicking Register Beamz will take you to the beamz web site where you can register your Beamz.

### Help button: About Beamz

Clicking the About Beamz command brings up a dialog showing your Beamz player version as well as a brief copyright notice.



**Note:** The version number of the software you are using will be displayed in this window. (version 1.1.0.109 was shown in this illustration)

Top [Previous](#)<sup>[16]</sup> [Next](#)<sup>[23]</sup>

## More Songs

Top [Previous](#)<sup>[23]</sup> [Next](#)<sup>[24]</sup>

The  button takes you to <http://www.thebeamz.com> where you can purchase more Beamz songs for your library.

## Overview

Top [Previous](#)<sup>[23]</sup> [Next](#)<sup>[24]</sup>

While just about anyone can have fun playing a Beamz unit with virtually no instruction, a few guidelines will serve to take your performances to the next level. The following sections will provide some basic suggestions that will increase your skill as well as your enjoyment of your Beamz system.

### Contents

- [Optimizing your Beamz setup](#)<sup>[24]</sup>
- [Beamz trigger types explained](#)<sup>[26]</sup>
- [Learning a Beamz song](#)<sup>[29]</sup>

## Optimizing your Beamz setup

Top [Previous](#)<sup>[24]</sup> [Next](#)<sup>[26]</sup>

Before you start playing, you should take a few minutes to make sure your Beamz hardware setup is optimally configured.

### 1. Find a flat, solid, level platform

Although we've tried to build the Beamz hardware as solidly as possible, you'll get the best results if you place your Beamz unit on a solid, stable surface. If you put it on a cushioned surface such as a mattress or a carpet, the Beamz controller arms may flex causing unexpected instrument triggers.



Make absolutely sure that no cables or other obstructions are present under the arms of your Beamz controller.

### 2. Declutter your setup

You'll also want to make sure that the USB cable connecting your Beamz controller to your computer and any other cables such as speaker connectors or mouse cables are out of your way, and that you can interact with the Beamz controller freely.

### 3. If possible, use external speakers or headphones

If you're using a desktop PC to run your Beamz system, you probably have a set of

speakers already, but if you're using a laptop, *please* don't depend upon the built-in speakers. You'll want to run either a set of external speakers that plug into your headphone out port, or, better yet, a patch cord that connects to your headphone out port and into an actual stereo system. Depending upon your particular setup, you may even have a digital audio out connector, which will provide you with the absolute best sound. If nothing else, a set of decent headphones will blow away even moderately expensive speaker systems (and they won't annoy the neighbors).

 Listening to loud music for extended periods of time will damage your hearing. Your parents weren't kidding and neither are we.

Top [Previous](#)<sup>[24]</sup> [Next](#)<sup>[26]</sup>

## Beamz trigger types

Top [Previous](#) [Next](#)

Once you finish messing around with the Beamz and seeing what a cacophonous mess you can make with the metal songs, you'll start to notice that in various songs, the lasers react in different ways. The technical term for the Beamz lasers is trigger, and when you break a Beamz laser, you are said to be triggering its corresponding instrument. All triggers are not created equal, however, and Beamz songs use different ones. The type of trigger used for a beam is usually displayed along with the name of the instrument on the main playing screen. These are the Beamz trigger types you might encounter in Beamz songs:

### Pulse triggers

Pulse triggers are the most common of the Beamz trigger types.

Each time you break a beam assigned to a pulse trigger, you'll get a single note from the assigned instrument. If you block a beam, you'll get a continuous stream of notes complementary to the rhythm accompaniment. The rate the notes are pulsed is also displayed as musical note values.

### One shot triggers

One shot triggers are the easiest triggers to describe since they do exactly what their name implies. No matter how long you break a beam to which a one shot trigger is assigned you'll get just a single note or "riff." You can break the beam repeatedly to get additional riffs. One shots might trigger voices, instrumental flourishes, or drum breaks. Again, a one shot trigger is triggered just once no matter how long you break the beam.

### Start / Stop triggers

Start and Stop triggers are used to start and stop a loop playing. The first time you break the beam, it starts a loop playing.

While the loop is playing, breaking the beam again will stop it. Breaking the beam a third time will start the loop playing from its beginning.

### Start/Pause triggers

Start/Pause triggers work the same way as Start/Stop except when stopped, it stops in place (pauses). Breaking the beam a third time will start the loop playing from where it was paused.

## **Momentary/Stop triggers**

Momentary/Stop triggers work the same way as Start/Stop except it loops only while the Beam Trigger is held on.

## **Momentary/Pause triggers**

Momentary/Pause triggers work the same way as Start/Pause except it loops only while the Beam Trigger is held on.

## **Advance triggers**

Advance triggers allow you to advance the melody of the currently playing song to the next "section" of the song. For example, let's say you're playing a classical piece and you're in a slow-going, low energy "tear-jerker" section. If you'd like to advance to the next section of the song, a high-energy full-on brass and percussion festival, you can trigger an Advance beam.

Top [Previous](#)<sup>[24]</sup> [Next](#)<sup>[28]</sup>

## Working with Beamz loop songs

Top [Previous](#) <sup>[26]</sup> [Next](#) <sup>[29]</sup>

Imagine an endless tape running in a never-ending loop. Then imagine that you add instruments to that loop at different locations and for different durations. The loop will run and run triggering the instruments at the point where they were recorded to the limit of their duration, continuing endlessly. A Beamz loop song (such as Minimalloop or Loop de Ville) works in exactly the same way.

The following figure shows a loop that triggers a marimba:

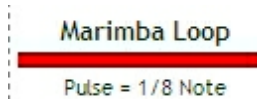

Loops usually run for four measures and then repeat.

To lay down loop instruments:

1. Start the song's rhythm accompaniment.
2. Block the loop beam that you want to layer on top of the rhythm accompaniment. You can block and hold the beam for a sequence of notes, or you can block the beam only long enough to trigger a single note.
3. A looped beam is automatically recorded and played back as an additional accompaniment rhythm. You should wait and listen to the complete cycle before adding additional loops.
4. Repeat for any other loop beams you'd like to add.
5. When you're satisfied, you can trigger non-loop beams normally.

When it comes to loop triggers you'll quickly find that less is more. Make sure that you don't totally clutter your sound stage with too many different loop sequences layered over each other.

Top [Previous](#) <sup>[26]</sup> [Next](#) <sup>[29]</sup>

## Learning a Beamz song

Top [Previous](#)<sup>[28]</sup> [Next](#)<sup>[30]</sup>

Yeah, you can spend plenty of time playing with the various songs and customizing beam layouts and such, but to get the absolute most out of your Beamz system, we recommend the following approach to "learning" a particular song:

1. Without the background melody running, trigger each laser in the first bank of sounds. When triggering a beam, experiment with breaking the beam continually and momentarily. For a run down on different trigger types and their behaviors, see [Beamz trigger types](#)<sup>[26]</sup>.
2. Switch to the second bank of sounds and trigger each laser, breaking each beam as explained above.
3. Next, start the background music, but don't trigger any beams. Instead listen to the whole background melody. Tap your foot in time to the music.





You'll find after following the procedure above that you've actually "mapped" out the song and you'll have a better handle on the sequence of melodic changes as well as the behavior of the Beamz triggers themselves. Again, the more time you can devote to *listening* to the various components of a song, the more competent you'll be when you begin to perform.

## Recording a performance

Top [Previous](#) [Next](#)

Recording your performance is easy. You'll notice at the bottom of the Beamz player is a strip of VCR-like commands:



To start recording, click the  button. Once you're finished, click the  button again. After you've recorded a section of song, you can also click the  button, and your recorded track will play in the background of the current song. Click the  button to pause the recorded track.

Once you've finished a recording, you can click the  button to save your recording. The following dialog is displayed:

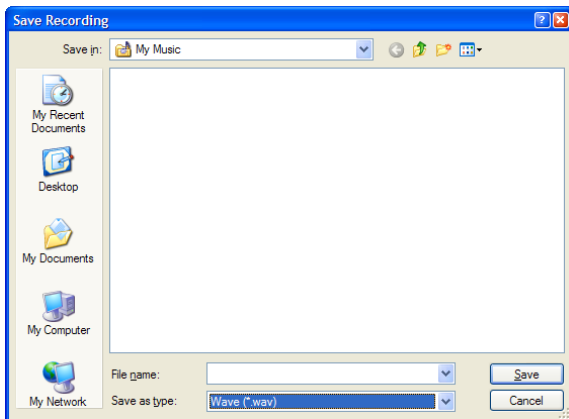

You can choose from two file types in the **Save as type** list box:

- **Wave (\*.wav)** Wave files are uncompressed recordings and tend to be quite large.
- **Windows Media (\*.wma)** Windows media files provide a good balance of compression and audio quality.

Generally, you'll want to choose the Windows Media format to conserve disk space.

You can only play a recorded song back within the Beamz interface immediately after recording. Once you switch songs or shut down the Beamz player, you'll need to play your recorded songs in a digital music player such as Windows Media Player.





Top [Previous](#) [Next](#)



## Swap and Hold

Top [Previous](#) [Next](#)

Swap and hold is a cool feature that lets you "stick" a particular beam in a continuous trigger mode without needing to keep the beam broken. To hold a particular beam, break and hold the beam while simultaneously pressing the Change Sounds button on the Beamz controller's base. The beam will continue to trigger (and will remain a steady green) until you switch back to it using the Change Sounds button and break the beam again. Swap and hold enables you to add to the existing rhythm accompaniment, or even create your own accompaniment.



-  Note that if the same instrument is also assigned to a different beam in the second bank, you can break the beam in that bank to stop the triggering.
-  If you press the large right Beamz controller button to stop the rhythm accompaniment, the held beams will continue to play until you break them again.

## Adjusting a song's tempo

Top [Previous](#) [Next](#)

You can adjust the speed at which a particular song plays by changing its tempo using the tempo control:



Click the  button to increase a song's tempo and click the  button to decrease it. To reset the song's tempo to its default value, click the  button.

In most songs, adjusting the tempo will affect the pitch of the instruments.

## Beamz product support

Top [Previous](#)<sup>[31]</sup> [Next](#)<sup>[33]</sup>

To view the latest list of frequently asked questions (FAQ), please visit <http://www.thebeamz.com/support/technical-faq>.

If you cannot find what you need in FAQ, please visit <http://www.thebeamz.com/> and click the Support tab.

## Software License Agreement

Top [Previous](#) [Next](#)

### Software License Agreement

This Software License Agreement (this “License”) is by and between you, the individual who has clicked on the “**I Agree**” button below (“You” or “Your”), and Beamz Interactive, Inc. (“Beamz”), and governs Your use of the software programs known as “Beamz Player Software” and “Beamz Studio Software”, as well as any documents and other materials which may accompany said software program or are otherwise provided in connection with this License (collectively, the “Software”).

Carefully read the following terms and conditions of this License. If You agree to the terms and conditions of this License in its entirety, then please indicate Your acceptance by clicking on the “**I Agree**” button found at the end of this License. If You do not agree to the terms and conditions of this License, then You are prohibited from downloading, installing or making any use of the Software or any other goods or services provided or to be provided under or in connection with this License.

This License shall be deemed made and entered into by You and Beamz as of the date of Your acceptance of this License.

#### **1. Grant of License.**

**1.1 License.** Subject to the terms and conditions of this License, Beamz grants You a limited, non-exclusive and non-transferable license to: (a) install from media included with the Beamz Interactive Music System hardware device or download from one of the Beamz websites located at <http://www.thebeamz.com>, <http://www.beamzmusic.com>, <http://www.beamzplanet.com>, or <http://www.beamzcommunity.com> onto no more than three (3) computer hardware devices owned or controlled by You; and (b) use the Software solely for Your personal and/or business use together with and as part of the Beamz Interactive Music System. Except as expressly provided for under this **Section 1.1**, You shall have no right to, and under no circumstances (including, without limitation, notions of fair use or other infringement defenses) shall You, copy or reproduce the Software, distribute, transmit, display, perform, disseminate or publish the Software, remove any notices or markings found on or made a part of the Software, circumvent any encryption devices made a part of the Software, modify, alter or change the Software, reverse compile, reverse assemble, reverse engineer or otherwise attempt to access, use or disclose the Software’s program or source code(s), transfer or sublicense this License to another party, or permit any third party to do any of the foregoing.

**1.2 Software Ownership.** The Software (together with all elements and derivatives thereof, including, without limitation, all copyrights, trademarks, patent rights, and trade secrets) is the sole and exclusive property of Beamz or, with regard to certain elements of the Software, the sole and exclusive property of a third party who has licensed the same to Beamz (with this License being a permissible sublicense thereof). Your right to use the Software is not coupled with an interest. In no event shall You own, have or retain any rights, titles or interests in or to the Software or any elements or derivatives thereof other than those limited rights expressly provided for under **Section 1.1** of this License.

**1.3 Reservation of Rights.** Nothing in this License shall restrict or limit any rights, titles or interests of Beamz or Beamz's third-party licensor in and to the Software. You are not entitled to make any uses of the Software other than those limited uses expressly provided for under **Section 1.1** of this License.

## **2. Confidentiality.**

**2.1 Non-disclosure.** Unless You have the express prior written consent of Beamz, You shall not directly or indirectly disseminate, divulge, transmit, publish, transfer, release or otherwise disclose to a third party: (a) any passwords or other access codes provided to You by Beamz for use in connection with the Software; (b) any non-public or proprietary information relating to the Software that is designated or identified as being "Confidential", "Proprietary" or of some similar designation; or (c) any non-public or proprietary information relating to the Software that You know or should know is considered highly sensitive and confidential (collectively, the "Confidential Information"). You must do all things necessary to prevent any of Your family members, roommates, officemates, agents, employees, representatives and other third parties from acquiring or disclosing the Confidential Information. Your agreement of non-disclosure is expressly part of the consideration for this License, and shall survive the termination of this License in perpetuity.

**2.2 Confidential Information Ownership.** The Confidential Information (together with all elements and derivatives thereof, including, without limitation, all copyrights, trademarks, patent rights, and trade secrets) is the sole and exclusive property of Beamz. Your right to use the Confidential Information (if any) is not coupled with an interest. Neither this License nor any disclosure of the Confidential Information grants You a license as to the Confidential Information by implication, estoppel, or otherwise under any patent, copyright, trade secret, trademark, or other proprietary right.

**3. Injunctive Relief.** You understand and acknowledge that the unauthorized use or disclosure of the Software or the Confidential Information will cause Beamz immediate and irreparable harm and significant injury, which may be difficult to measure with certainty or to compensate through monetary damages. Therefore, You agree that in the event You directly, indirectly or inadvertently cause an unauthorized use or disclosure of the Software or the Confidential Information, Beamz shall be entitled to obtain a temporary restraining order, a preliminary injunction, a temporary injunction and/or a permanent injunction, without the necessity of a bond, against such breach from any court of competent jurisdiction. Beamz's right to obtain such relief shall not limit its right to obtain other remedies. In addition, Beamz may seek commensurate remuneration for any and all activities required to investigate and verify the unauthorized use or disclosure of the Software or the Confidential Information.

**4. Termination.** This License, and the limited rights granted to You under this License, shall automatically terminate upon the earlier of either: (a) the material or immaterial breach of any term or condition of this License by or because of You; or (b) Beamz providing You with written notice of the termination of this License for any reason or for no reason. Upon the termination of this License, or upon Beamz providing You with written notice for any reason or for no reason, You shall immediately destroy the Software, the Confidential Information and any copies thereof in Your possession, custody or control, and immediately confirm in writing to Beamz that You have done so. The following rights and obligations of the parties hereunder shall survive the termination of this License: (x) all rights and obligations which accrued as of

the termination of this License; (y) all rights and obligations under Sections 1.2, 1.3, 2.1, 2.2, 3, 4, 6, 7, 8, 9 and 10 of this License; and (z) any and all other rights and obligations under provisions which by their terms, conditions, nature or implication are expressly stated to, or are intended to, survive the termination of this License.

**5. Support Services.** Beamz provides commercially reasonable web-based and telephone Software support services during Beamz's normal business hours (the "Support Services"). You may access the Support Services by visiting the Beamz website located at <http://www.thebeamz.com>, or by calling (888) 724-7380.

**6. Disclaimer.** Your download, installation and use of the Software, the Confidential Information and the Support Services are done at Your own risk. Beamz does not make, nor has Beamz made, any representations or warranties of any kind or nature (whether direct or indirect, whether oral or in written, or whether express or implied) to You with respect to the Software, the Confidential Information, the Support Services or any other goods or services provided or to be provided under or in connection with this License. Accordingly, Beamz expressly disclaims any and all express warranties, implied warranties (including, without limitation, implied warranties of merchantability, fitness for a particular purpose, good faith and fair dealing, title, non-infringement, quality, and performance), and warranties arising from conduct, course of dealing, custom and usage in trade. Beamz has made no affirmation of fact or promise relating to the Software, the Confidential Information, the Support Services or any other goods or services provided or to be provided under or in connection with this License that has become any basis of this bargain. There are no warranties (express, implied or other) that extend beyond the description on the face of this License; the Software, the Confidential Information, the Support Services and any other goods and services provided or to be provided under or in connection with this License are provided on an "as is" basis.

**7. General Release and Waiver.** You expressly, irrevocably and unconditionally waive, release and discharge Beamz and Beamz's officers, directors, owners, partners, agents, employees, affiliates, successors and assigns from any and all liabilities, claims, suits, demands, actions, judgments, losses and damages (including, without limitation, direct, indirect, punitive and special damages, costs, attorneys' fees, lost profits, lost business opportunities, and insurance expenses) whatsoever which You or any third party have or may have against them for indemnification, damage to personal property, breach of or interference with a third-party warranty or contract, negligence, recklessness, products liability, criminal liability, infringement, invasion of the right of privacy, violation of the right of publicity, defamation, disparagement, indecency, obscenity, fraud, misrepresentation, discrimination, indemnification, reimbursement and/or any other legal theory arising from or in connection with the Software, the Confidential Information, the Support Services or any other goods or services provided or to be provided under or in connection with this License.

**8. Limitation of Liability.** In no event shall Beamz or Beamz's officers, directors, owners, partners, agents, employees, representatives, affiliates, successors or assigns be liable to (or be obligated to indemnify) You or any third party for any indirect, punitive or special damages, costs, attorneys' fees, lost profits, lost business opportunities or insurance expenses for or in connection with any claim of breach of contract, breach of warranty, indemnification, damage to personal property, breach of or interference with a third-party warranty or contract, negligence, recklessness, products liability, criminal liability, infringement, invasion of the right of privacy, violation of the right of publicity, defamation, disparagement, indecency, obscenity, fraud, misrepresentation, discrimination, indemnification, reimbursement and/or any other legal theory arising from or in connection with the Software, the Confidential Information, the Support Services or any other goods or

services provided or to be provided under or in connection with this License.

**9. Representations and Warranties.** You represent and warrant to Beamz that: (a) You are a natural person; (b) You have read this License in its entirety; (c) You have the full right and authority to enter into and abide by the terms and conditions of this License in its entirety; (d) and You voluntarily accept and agree to the terms and conditions of this License in its entirety.

**10. Miscellaneous.**

**10.1 No Assignment or Delegation.** You shall not assign, delegate or otherwise transfer any of Your rights or obligations under this Agreement without Beamz's prior written consent. Any purported transfer without such prior written consent shall be void. Beamz shall have the unencumbered and unlimited right to freely assign, delegate and otherwise transfer any of its rights and obligations under this Agreement.

**10.2 Waiver of Rights.** A party's delay or failure to exercise a right or remedy available hereunder shall not constitute a waiver of such right or remedy. Any waiver of any rights or remedies of Beamz must be in a writing signed by Beamz.

**10.3 Headings.** Headings are inserted for reference and convenience only and in no way define, limit or describe the scope or intent of this License.

**10.4 Governing Law.** This License shall be governed, interpreted and enforced in accordance with the laws of the State of Arizona and applicable federal law of the United States, regardless of the place of its execution or performance and any conflicts of law analysis. For the avoidance of any doubt, The United Nations Convention on Contracts for the International Sale of Goods shall not apply to this License. The parties irrevocably agree, consent and otherwise submit to the exclusive jurisdiction of a court of appropriate jurisdiction located in Maricopa County, Arizona for the adjudication of any dispute, controversy or claim arising from or in connection with this License.

**10.5 Severability.** If any term or condition of this License is held invalid or unenforceable by a court of appropriate jurisdiction, then said term or condition shall be fully severed from this License and the remaining terms and conditions shall not be affected.

**10.6 Modification.** No modification, amendment, release or waiver of this License, in whole or in part, by You shall be valid unless it is in writing and signed by both parties. Beamz, and only Beamz, shall have the right to modify, amend, release or waive this License, in whole or in part, without Your prior written consent; provided, however, that Beamz notifies You of any such modification, amendment, release or waiver, and that any such modification, amendment, release or waiver shall not apply to any dispute of which You and Beamz had actual notice of on or before the date of such modification, amendment, release or waiver.

**10.7 Entire Agreement.** This License sets forth the entire agreement understanding between the parties and supersedes all prior agreements, if any, made between the parties (orally or in writing) relative to the subject matter of this License. This License shall inure to the benefit of and be binding upon the parties and their respective affiliates, successors and assigns.

## Beamz® User Manual

**10.8 Contact and Notices.** Please direct any questions or comments You may have about the Software to:

Beamz Interactive, Inc.  
Attention: Customer Relations  
15354 North 83rd Way, Suite 102  
Scottsdale, Arizona 85260  
E-mail: [sales@thebeamz.com](mailto:sales@thebeamz.com)

Copyright © 2010 Beamz Interactive, Inc. All Rights Reserved.

BEAMZ<sup>®</sup>, and PLAY THE LIGHT<sup>®</sup> are all registered trademarks of Beamz Interactive, Inc., and may not be used without the express written consent of Beamz Interactive, Inc.

If You agree to the terms and conditions of this License in its entirety, then please indicate Your acceptance and agreement by clicking on the “**I Agree**” button below.

Top [Previous](#)<sup>[32]</sup> [Next](#)<sup>[38]</sup>

## Song License Agreement

Top [Previous](#) [Next](#)

### Song License Agreement

This Song License Agreement (this “License”) is by and between you, the individual who has clicked on the “**I Agree**” button below (“You” or “Your”), and Beamz Interactive, Inc. (“Beamz”), and governs Your use of the song (together with its musical composition and sound recording) which You are attempting to install from media included with the Beamz Interactive Music System hardware device and/or download from one of the Beamz websites located at <http://www.thebeamz.com>, <http://www.beamzmusic.com>, <http://www.beamzplanet.com>, <http://www.beamzcommunity.com> as well as any documents and other materials which may accompany said song or are otherwise provided in connection with this License (collectively, the “Song”).

Carefully read the following terms and conditions of this License. If You agree to the terms and conditions of this License in its entirety, then please indicate Your acceptance by clicking on the “**I Agree**” button found at the end of this License. If You do not agree to the terms and conditions of this License, then You are prohibited from downloading, installing or making any use of the Song or any other goods or services provided or to be provided under or in connection with this License.

This License shall be deemed made and entered into by You and Beamz as of the date of Your acceptance of this License.

#### 1. **Grant of License.**

**1.1 License.** Subject to the terms and conditions of this License, Beamz grants You a limited, non-exclusive and non-transferable license to download and install one (1) copy of the Song from media included with the Beamz Interactive Music System hardware device or from download from one of the Beamz websites identified above onto no more than three (3) computer hardware devices owned or controlled by You, and to make the following limited non-commercial uses of the Song as part of the Beamz interactive music system: (a) to privately perform the Song on the Beamz interactive music system; (b) to compose and add additional, non-infringing musical tracks on different laser beams in the Beamz Interactive Music System that can be played along with the Song; (c) to make and record Your private performance of the Song on the Beamz interactive music system; and (d) to share Your authorized recording of Your private performance of the Song on the Beamz interactive music system on any Internet websites which Beamz specifically designates from time to time as a so-called “Beamz Community Website” (including but not limited to those noted above) and, subject to securing any third party rights that may be applicable, on your personal social media sites (ie. facebook, MySpace, etc.) . Except as expressly provided for under this **Section 1.1**, You shall have no right to, and under no circumstances (including, without limitation, notions of fair use or other infringement defenses) shall You, copy or reproduce the Song, distribute, transmit, display, perform, disseminate or publish the Song, remove any notices or markings found on or made a part of the Song, circumvent any encryption devices made a part of the Song, modify, alter or change the Song, transfer or sublicense this License to another party, or permit any third party to do any of the foregoing.

**1.2 Song Ownership.** The Song (together with all elements and derivatives thereof, including, without limitation, all musical compositions, sound recordings, copyrights, trademarks, patent rights,



and trade secrets) is the sole and exclusive property of a third party who has licensed the same to Beamz (with this License being a permissible sublicense thereof). Your right to use the Song is not coupled with an interest. In no event shall You own, have or retain any rights, titles or interests in or to the Song or any elements or derivatives thereof other than those limited rights expressly provided for under **Section 1.1** of this License.

**1.3 Reservation of Rights.** Nothing in this License shall restrict or limit any rights, titles or interests of Beamz or Beamz's third-party licensor in and to the Song. You are not entitled to make any commercial or non-commercial uses of the Song other than those limited uses expressly provided for under **Section 1.1** of this License. Any use of the Song which may fall outside the scope of this License (including, without limitation, and by way of example only, the public performance of the Song on the Beamz interactive music system, and the manufacture and distribution of phonorecords which embody a performance of the Song on the Beams interactive music system) shall require the written consent of both Beamz and the Song's owner(s).

**2. Injunctive Relief.** You understand and acknowledge that the unauthorized use or disclosure of the Song or the Confidential Information will cause Beamz immediate and irreparable harm and significant injury, which may be difficult to measure with certainty or to compensate through monetary damages. Therefore, You agree that in the event You directly, indirectly or inadvertently cause an unauthorized use or disclosure of the Song or the Confidential Information, Beamz shall be entitled to obtain a temporary restraining order, a preliminary injunction, a temporary injunction and/or a permanent injunction, without the necessity of a bond, against such breach from any court of competent jurisdiction. Beamz's right to obtain such relief shall not limit its right to obtain other remedies. In addition, Beamz may seek commensurate remuneration for any and all activities required to investigate and verify the unauthorized use or disclosure of the Song.

**3. Termination.** This License, and the limited rights granted to You under this License, shall automatically terminate upon the earlier of either: (a) the material or immaterial breach of any term or condition of this License by or because of You; or (b) Beamz providing You with written notice of the termination of this License for any reason or for no reason. Upon the termination of this License, or upon Beamz providing You with written notice for any reason or for no reason, You shall immediately destroy the Song and any copies thereof in Your possession, custody or control, and immediately confirm in writing to Beamz that You have done so. The following rights and obligations of the parties hereunder shall survive the termination of this License: (x) all rights and obligations which accrued as of the termination of this License; (y) all rights and obligations under Sections 1.2, 1.3, 2, 3, 4, 5, 6, 7, and 8 of this License; and (z) any and all other rights and obligations under provisions which by their terms, conditions, nature or implication are expressly stated to, or are intended to, survive the termination of this License.

**4. Disclaimer.** Your download, installation and use of the Song are done at Your own risk. Beamz does not make, nor has Beamz made, any representations or warranties of any kind or nature (whether direct or indirect, whether oral or in written, or whether express or implied) to You with respect to the Song or any other goods or services provided or to be provided under or in connection with this License. Accordingly, Beamz expressly disclaims any and all express warranties, implied warranties (including, without limitation, implied warranties of merchantability, fitness for a particular purpose, good faith and fair dealing, title, non-infringement, quality, and performance), and warranties arising from conduct, course of dealing, custom and usage in trade. Beamz has made no affirmation of fact or promise relating to the Song or any other goods or services provided or to be provided under or in connection with this License that has become any basis of this

bargain. There are no warranties (express, implied or other) that extend beyond the description on the face of this License; the Song and any other goods and services provided or to be provided under or in connection with this License are provided on an “as is” basis.

**5. General Release and Waiver.** You expressly, irrevocably and unconditionally waive, release and discharge Beamz and Beamz’s officers, directors, owners, partners, agents, employees, affiliates, successors and assigns from any and all liabilities, claims, suits, demands, actions, judgments, losses and damages (including, without limitation, direct, indirect, punitive and special damages, costs, attorneys’ fees, lost profits, lost business opportunities, and insurance expenses) whatsoever which You or any third party have or may have against them for indemnification, damage to personal property, breach of or interference with a third-party warranty or contract, negligence, recklessness, products liability, criminal liability, infringement, invasion of the right of privacy, violation of the right of publicity, defamation, disparagement, indecency, obscenity, fraud, misrepresentation, discrimination, indemnification, reimbursement and/or any other legal theory arising from or in connection with the Song, the Confidential Information or any other goods or services provided or to be provided under or in connection with this License.

**6. Limitation of Liability.** In no event shall Beamz or Beamz’s officers, directors, owners, partners, agents, employees, representatives, affiliates, successors or assigns be liable to (or be obligated to indemnify) You or any third party for any indirect, punitive or special damages, costs, attorneys’ fees, lost profits, lost business opportunities or insurance expenses for or in connection with any claim of breach of contract, breach of warranty, indemnification, damage to personal property, breach of or interference with a third-party warranty or contract, negligence, recklessness, products liability, criminal liability, infringement, invasion of the right of privacy, violation of the right of publicity, defamation, disparagement, indecency, obscenity, fraud, misrepresentation, discrimination, indemnification, reimbursement and/or any other legal theory arising from or in connection with the Song or any other goods or services provided or to be provided under or in connection with this License.

**7. Representations and Warranties.** You represent and warrant to Beamz that: (a) You are a natural person; (b) You have read this License in its entirety; (c) You have the full right and authority to enter into and abide by the terms and conditions of this License in its entirety; (d) and You voluntarily accept and agree to the terms and conditions of this License in its entirety.

**8. Miscellaneous.**

**8.1 No Assignment or Delegation.** You shall not assign, delegate or otherwise transfer any of Your rights or obligations under this Agreement without Beamz’s prior written consent. Any purported transfer without such prior written consent shall be void. Beamz shall have the unencumbered and unlimited right to freely assign, delegate and otherwise transfer any of its rights and obligations under this Agreement.

**8.2 Waiver of Rights.** A party’s delay or failure to exercise a right or remedy available hereunder shall not constitute a waiver of such right or remedy. Any waiver of any rights or remedies of Beamz must be in a writing signed by Beamz.

**8.3 Headings.** Headings are inserted for reference and convenience only and in no way define, limit or describe the scope or intent of this License.

**8.4 Governing Law.** This License shall be governed, interpreted and enforced in accordance with the laws of the State of Arizona and applicable federal law of the United States, regardless of the place of its execution or performance and any conflicts of law analysis. For the avoidance of any doubt, The United Nations Convention on Contracts for the International Sale of Goods shall not apply to this License. The parties irrevocably agree, consent and otherwise submit to the exclusive jurisdiction of a court of appropriate jurisdiction located in Maricopa County, Arizona for the adjudication of any dispute, controversy or claim arising from or in connection with this License.

**8.5 Severability.** If any term or condition of this License is held invalid or unenforceable by a court of appropriate jurisdiction, then said term or condition shall be fully severed from this License and the remaining terms and conditions shall not be affected.

**8.6 Modification.** No modification, amendment, release or waiver of this License, in whole or in part, by You shall be valid unless it is in writing and signed by both parties. Beamz, and only Beamz, shall have the right to modify, amend, release or waive this License, in whole or in part, without Your prior written consent; provided, however, that Beamz notifies You of any such modification, amendment, release or waiver, and that any such modification, amendment, release or waiver shall not apply to any dispute of which You and Beamz had actual notice of on or before the date of such modification, amendment, release or waiver.

**8.7 Entire Agreement.** This License sets forth the entire agreement understanding between the parties and supersedes all prior agreements, if any, made between the parties (orally or in writing) relative to the subject matter of this License. This License shall inure to the benefit of and be binding upon the parties and their respective affiliates, successors and assigns.

**8.8 Contact and Notices.** Please direct any questions or comments You may have about the Song or any Song commercial use permission requests to:

Beamz Interactive, Inc.  
Attention: Customer Relations  
15354 North 83rd Way, Suite 102  
Scottsdale, Arizona 85260  
E-mail: [sales@thebeamz.com](mailto:sales@thebeamz.com)

Copyright © 2010 Beamz Interactive, Inc. All Rights Reserved.

BEAMZ<sup>®</sup>, and PLAY THE LIGHT<sup>®</sup> are all registered trademarks of Beamz Interactive, Inc., and may not be used without the express written consent of Beamz Interactive, Inc.

If You agree to the terms and conditions of this License in its entirety, then please indicate Your acceptance and agreement by clicking on the “**I Agree**” button below.

Video Song Publisher Disclosure

Song	Artist	Publishers
Heart Of Glass	Blondie	Chrysalis Music Group Inc. o/b/o itself and Monster

## Beamz® User Manual

		Island Publishing Corp.
No Rain	Blind Melon	(C) 1992 EMI APRIL MUSIC INC. and HEAVY MELON MUSIC All Rights Controlled and Administered by EMI APRIL MUSIC INC. (ASCAP) All Rights Reserved. International Copyright Secured. Used by Permission.
Alice	Moby	Richard Hall Music (BMI) Administered by Kobalt Music Publishing America, Inc
Disco Lies	Moby	Richard Hall Music (BMI) Administered by Kobalt Music Publishing America, Inc
Right As Rain	Tommy Castro	Viper Music, BMI/Viper Music obo Tommy Castro Music
She's Too Busy	Smokin Joe Kubek & Bnois	Viper Music BMI
Ice Ice Baby	Vanilla Ice	EMI Music Publishing (BMI) / Tintoretto Music (BMI) / Sony/ATV Songs LLC d/b/a Epic/Solar
Mony Mony	Billy Idol	EMI Longitude Music, All Rights Reserved. International Copyright Secured. Used by Permission.
U Can't Touch This	MC Hammer	Jobete Music Company, Inc / Stone Diamond Music Corp (ASCAP) / Bust It Publishing (BMI)
The Best Thing	Relient K	Gotee Music / Red Coats Are Coming Publishing (BMI)

Top [Previous](#) <sup>33</sup> [Next](#) <sup>43</sup>

## Legal and safety notices

Top [Previous](#) [Next](#)

The Beamz laser based musical instrument uses low power laser beams to sense the motion of your hands while performing. These lasers are designated as “Class 2”. This is the same level of laser light used for standard grocery store scanners. The lasers are of such low power that they cannot cause any harm to skin. Additionally, the laser power is so low that eye injury is not possible unless someone stares in the beam source.

### Laser Safety Warnings:

- Class 2 Laser Product
- Do not stare into beam
- Adults should initially explain the hazards to children and ensure that children use the product properly.
- Remove rings, watches and other shiny jewelry prior to use to prevent reflection of the laser beams toward the eyes of operators or spectators.
- Do not insert head between the U shaped laser brackets. This action could allow direct eye exposure by the lasers.
- Do not insert any shiny objects or mirrors in the beam path.
- Do not attempt to reflect the lasers out of their normal path.
- If U shaped laser brackets are bent or broken such that the lasers are not terminated on the other side of the U, do not operate the product.

### Laser Emission Data

The product parameters are as follows:

- Laser Product Class: 2
- Laser Classification Standard: IEC 60285-1
- Number of Lasers: 6
- Laser Power, Peak: <1 milliwatt
- Laser Wavelength = 650nm nominal
- Laser Pulse Length: 875usec
- Laser Pulse frequency: 1 KHz
- Pulse Energy: 830nj
- Beam Divergence: <7mrad
- Beams Diameter: <5mm
- Beam TEM Mod: TEM00



**Caution:** use of controls or adjustments or performance of procedures other than those specified herein may result in hazardous radiation exposure.

## Regulatory Requirements

### FDA/CDRH

1. Hazard Warning Symbol



2. Explanatory Label



3. Manufacturer's ID & Certification Statement

Beamz Interactive, Inc. [www.thebeamz.com](http://www.thebeamz.com)  
15354 N. 83rd Way, Ste 102 Scottsdale, AZ 85260 USA  
Date of manufacture: April 2010

S/N:  
Product Name: Beamz®  
Product Model Number: C6  
Made in Taiwan SBC-001

**CE**  
**UL LISTED**  
MUSICAL INSTRUMENT  
3RHE

**FC**  
Class B

This Class B digital apparatus complies with Canadian ICES-003.  
Protected under US Patents 6,960,715 and 7,504,577. Other US and foreign patents pending. Complies with FDA performance standards for laser products except for deviations pursuant to Laser Notice No. 50, dated June 24, 2007.

C6-PI-03

## Laser Safety Label Location Diagram

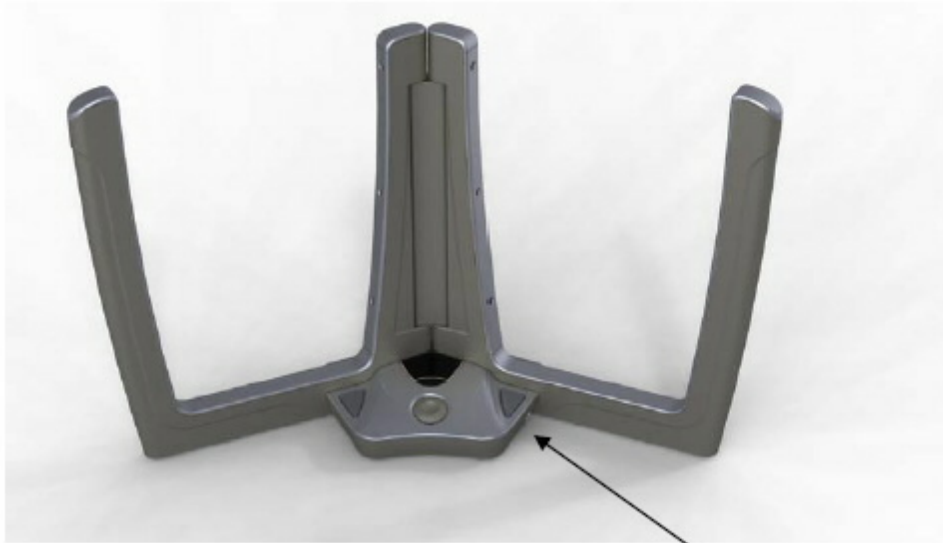

Warning Labels are located on side next to the USB connector as shown.

The manufacturer's identification label & certification statement may be located on the bottom or rear of the product depending on model.

## Maintenance

Maintenance is limited to cleaning the housing and changing laser U arms. Prior to cleaning the housing or changing arms, disconnect power and USB cable. Clean housing with damp soft cotton cloth. Do not use solvents or cleaners. If a laser fails in the laser U arms, contact the manufacturer.

No service is possible or allowed by the customer. Contact manufacturer for technical assistance if you feel your Beamz unit is malfunctioning. Do not attempt to disassemble or modify unit.

## Certification

No maintenance of service is required to keep unit in compliance with US and International Laser Regulations.

This product complies with US Laser Product Safety Requirements. Under 21 CFR 1040.10 & .11. This product is also compliant with International Laser Safety Standards “IEC 60825-1” via the terms of US Laser Notice No. 50.

BEAMZ is a US certified Class 2 laser product.

## FCC

### DECLARATION OF CONFORMITY

Trade Name: Beamz music system

Product Name: Beamz

Product Model Number: C6

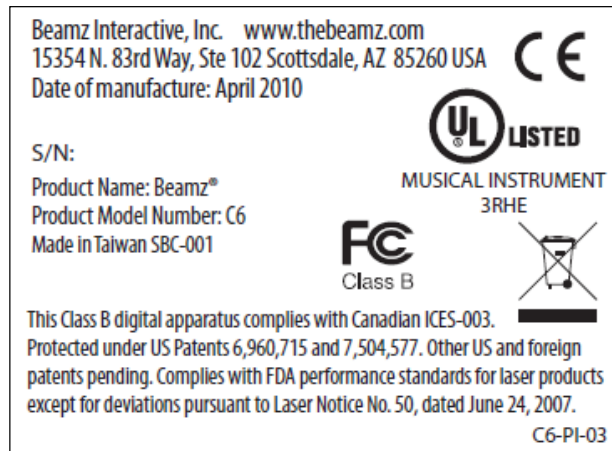

### These devices comply with Part 15.2 of the FCC Rules Part 15.2.

Changes or modifications not expressly approved by the party responsible for compliance could void the user’s authority to operate the equipment.



The manufacturer is not responsible for any radio or TV interference caused by unauthorized modifications to this equipment. Such modifications could void the



user's authority to operate the equipment.

## CE

### Manufacturer's Declaration of Conformity

We declare under our sole responsibility that the HumanBeams C6 LMS, to which this declaration relates, is in conformity with the following standards or other normative documents:

CE Mark:

- EN55022 Class B (EMC)
- EN55024 - (Immunity)
- EN60950 - (Safety)
- This product complies with European Directive 1995/5/EC.

### Manufacturer's Disclaimer Statement

The information in this document is subject to change without notice and does not represent a commitment on the part of the vendor. No warranty or representation, either expressed or implied, is made with respect to the quality, accuracy or fitness for any particular purpose of this document. The manufacturer reserves the right to make changes to the content of this document and/or the products associated with it at any time without obligation to notify any person or organization of such changes. In no event will the manufacturer be liable for direct, indirect, special, incidental or consequential damages arising out of the use or inability to use this product or documentation, even if advised of the possibility of such damages. This document contains materials protected by copyright. All rights are reserved. No part of this manual may be reproduced or transmitted in any form, by any means or for any purpose without expressed written consent of its authors. Product names appearing in this document are mentioned for identification purchases only. All trademarks, product names or brand names appearing in this document are registered property of their respective owners.

### Beamz Interactive, Inc.

15354 N 83rd Way, Ste 102

Scottsdale, AZ 85260

Tel: 888-724-7380

[www.thebeamz.com](http://www.thebeamz.com)

## Trademarks and warranty information

Top [Previous](#) 

Please make sure that you read all instructions in this user guide prior to operating the Beamz product.

Copyright 2010 Beamz Interactive, Inc.

All Rights Reserved.

Beamz and Play The Light are registered trademarks of Beamz Interactive, Inc. No trademark of Beamz Interactive, Inc. may be used without prior written permission.

Marks and brands are property of their respective owners.

## Warranty

BEAMZ INTERACTIVE, INC. LIMITED WARRANTY FOR BEAMZ PRODUCTS, ACCESSORIES AND SOFTWARE.

### 1. STATEMENT

Beamz Interactive, Inc. (“Beamz”) hereby warrants to you that the Beamz brand music performance product (“Product”) accompanying this Limited Warranty (“Warranty”) shall materially conform to its accompanying written documentation and written specifications (collectively, the “Specifications”), in normal use consistent with the Specifications, for one (1) year from the date of original purchase thereof from Beamz or an authorized Beamz reseller (the “Warranty Period”). If any Product does not materially conform to the foregoing Warranty, you **MUST PROVIDE PROOF OF PURCHASE AND** may contact Beamz at the telephone number or email address below to determine whether the Product is subject to this Warranty. Where the Product is subject to this Warranty, Beamz may direct you to return such Product to Beamz, at your risk and expense and no later than ten (10) days after the end of the Warranty Period. After Beamz has received such returned Product, Beamz shall, at its option, either repair or replace such Product, and shall in either case return such Products to you at Beamz’s risk and expense. Returned Products shall be subject to the balance of the Warranty Period otherwise applicable, but in no event less than ninety (90) days. Any reconditioned parts used by Beamz shall be subject to all the same provisions as otherwise applicable to new parts. The foregoing describes Beamz’s sole liability, and your sole remedy, under this Warranty.

### 2. WARRANTY EXCLUSIONS

The foregoing Warranty does not cover and shall be void for defects or damages resulting from casualty, accident, misuse or abuse, neglect, alterations, service or repair other than by Beamz or its independent third party service providers (including without limitation by you), improper installation, operation or maintenance, improper connections with peripherals or other causes not arising out of defects in the materials or workmanship of Products. Beamz shall not be responsible for damage to or loss of repaired or replaced Products during shipping by Beamz.

### 3. PROCEDURE FOR WARRANTY SERVICE

Prior to returning any Products to Beamz, you must first contact Beamz, either by telephone (at (888) 724-7380) or email (to “support@thebeamz.com”), to confirm that such Products are covered by the foregoing Warranty. If

## Beamz® User Manual

such Products are so covered, you shall obtain from Beamz a return merchandise authorization (“RMA”) number and shipping instructions prior to any shipment of such Products to Beamz, and shall include such RMA with any corresponding Product shipment. All shipments shall be in the original retail carton with interior foam.

### 4. DAMAGES

IN NO EVENT SHALL BEAMZ BE LIABLE TO YOU OR ANY THIRD PARTY FOR ANY INDIRECT, SPECIAL, INCIDENTAL, CONSEQUENTIAL OR PUNITIVE DAMAGES, HOWEVER AND WHEREVER ARISING, AND REGARDLESS OF WHETHER ADVISED OF THE POSSIBILITY OF SUCH DAMAGES. IN NO EVENT SHALL THE TOTAL LIABILITY OF BEAMZ, ITS OFFICERS, DIRECTORS, OWNERS, AGENTS, AND AFFILIATES FOR ANY CLAIM ASSOCIATED WITH OR ARISING FROM THIS WARRANTY OR ANY PRODUCT EXCEED THE AMOUNT ACTUALLY PAID TO BEAMZ FOR THE PRODUCT WHICH IS THE SUBJECT OF SUCH CLAIM. Some jurisdictions do not allow limitations of certain damages so the foregoing may not apply to you.

### 5. WARRANTY DISCLAIMER AND LIMITATIONS

THE FOREGOING STATES BEAMZ'S SOLE AND EXCLUSIVE WARRANTY TO YOU AND ANY THIRD PARTY CONCERNING THE PRODUCTS (INCLUDING WITHOUT LIMITATION SPARE PARTS, DOCUMENTATION, CUSTOMIZATIONS AND CONSUMABLES), AND ALL DELIVERABLE ITEMS HEREUNDER. BEAMZ MAKES NO ADDITIONAL WARRANTIES, EXPRESS, IMPLIED, ARISING FROM COURSE OF DEALING OR USAGE OF TRADE, OR STATUTORY, AS TO THE PRODUCTS OR ANY MATTER WHATSOEVER. THIS IS A LIMITED WARRANTY AND IS THE ONLY WARRANTY MADE BY BEAMZ. YOU SHALL NOT HAVE THE RIGHT TO MAKE OR PASS ON, AND SHALL TAKE ALL MEASURES NECESSARY TO ENSURE THAT NEITHER YOU NOR ANY OF ITS AGENTS OR EMPLOYEES SHALL MAKE OR PASS ON, ANY EXPRESS OR IMPLIED WARRANTY OR REPRESENTATION ON BEHALF OF BEAMZ TO ANY CUSTOMER OR THIRD PARTY. Some jurisdictions do not allow disclaimers of certain warranties so the foregoing may not apply to you.

### 6. LAW

This Warranty is subject to the laws of the State of Arizona as apply to contracts entered into and performed in Arizona between Arizona residents, and without regard to conflict of laws principles. Any dispute regarding this Warranty or the Products shall be subject to the sole jurisdiction of the State and Federal Courts located in Maricopa County, Arizona, and you hereby consent to the personal jurisdiction of such courts.

### 7. CONTACT

If you have any questions about the Products or this Warranty, you may contact Beamz by telephone at (888)-724-7380 by email (to “support@thebeamz.com”), or by writing to: Beamz Interactive, Inc., Attn: Customer Support, 15354 N 83rd Way, Ste 102, Scottsdale, AZ 85260.

Top [Previous](#)<sup>43</sup>