

NI 625x Specifications

Specifications listed below are typical at 25 °C unless otherwise noted. Refer to the *M Series User Manual* for more information about NI 625x devices.

このドキュメントの日本語版については、ni.com/manuals を参照してください。
(For a Japanese language version, go to ni.com/manuals.)

Analog Input

Number of channels		CMRR (DC to 60 Hz)	100 dB
NI 6250/6251	8 differential or 16 single ended	Input impedance	
NI 6254/6259	16 differential or 32 single ended	Device on	
NI 6255	40 differential or 80 single ended	AI+ to AI GND	>10 GΩ in parallel with 100 pF
ADC resolution	16 bits	AI- to AI GND	>10 GΩ in parallel with 100 pF
DNL	No missing codes guaranteed	Device off	
INL	Refer to the <i>AI Absolute Accuracy Table</i>	AI+ to AI GND	820 Ω
Sampling rate		AI- to AI GND	820 Ω
Maximum		Input bias current	±100 pA
NI 6250/6251/6254/6259	1.25 MS/s single channel, 1.00 MS/s multi-channel (aggregate)	Crosstalk (at 100 kHz)	
NI 6255	1.25 MS/s single channel 750 kS/s multi-channel (aggregate)	Adjacent channels	-75 dB
Minimum	No minimum	Non-adjacent channels	-95 dB ¹
Timing accuracy	50 ppm of sample rate	Small signal bandwidth (-3 dB)	1.7 MHz
Timing resolution	50 ns	Input FIFO size	4,095 samples
Input coupling	DC	Scan list memory	4,095 entries
Input range	±10 V, ±5 V, ±2 V, ±1 V, ±0.5 V, ±0.2 V, ±0.1 V	Data transfers	
Maximum working voltage for analog inputs (signal + common mode)	±11 V of AI GND	PCI/PCIe/PXI/PXIe devices	DMA (scatter-gather), interrupts, programmed I/O
		USB devices	USB Signal Stream, programmed I/O

¹ For USB-6255 devices, channel AI <0..15> crosstalk to channel AI <64..79> is -67 dB; applies to channels with 64-channel separation, for example, AI (x) and AI (x + 64).

Overvoltage protection (AI <0..79>, AI SENSE, AI SENSE 2)

Device on±25 V for up to
four AI pins

Device off±15 V for up to
four AI pins

Input current during
overvoltage condition±20 mA max/AI pin

Settling Time for Multichannel Measurements

NI 6250/6251/6254/6259

Range	±60 ppm of Step (±4 LSB for Full Scale Step)	±15 ppm of Step (±1 LSB for Full Scale Step)
±10 V, ±5 V, ±2 V, ±1 V	1 μs	1.5 μs
±0.5 V	1.5 μs	2 μs
±0.2 V, ±0.1 V	2 μs	8 μs

NI 6255

Range	±60 ppm of Step (±4 LSB for Full Scale Step)	±15 ppm of Step (±1 LSB for Full Scale Step)
±10 V, ±5 V, ±2 V, ±1 V	1.3 μs	1.6 μs
±0.5 V	1.8 μs	2.5 μs
±0.2 V, ±0.1 V	3 μs	8 μs

Typical Performance Graphs

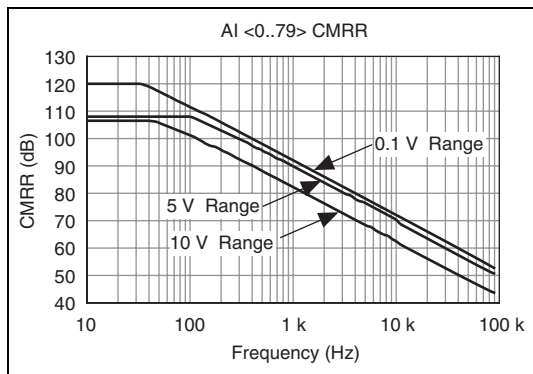
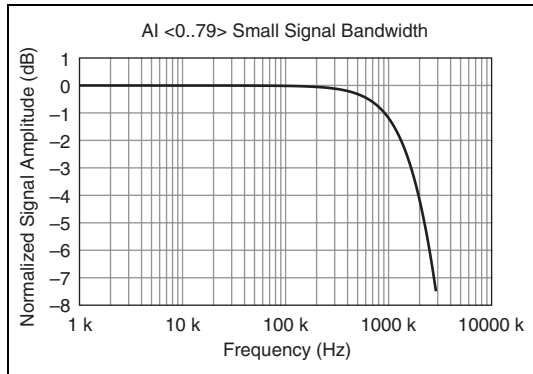
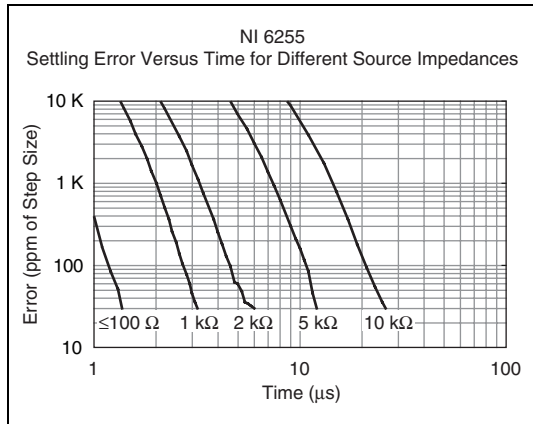
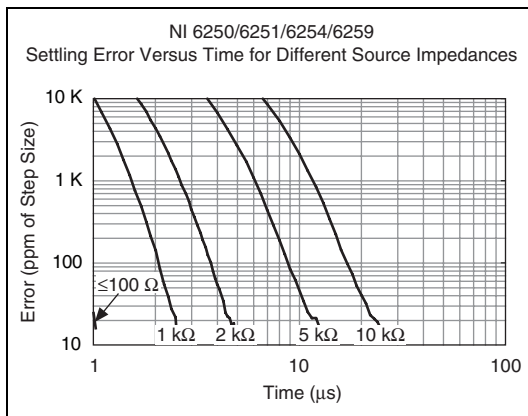

Analog Triggers

Number of triggers	1
Source	
NI 6250/6251	AI <0..15>, APFI 0
NI 6254/6259	AI <0..31>, APFI <0..1>
NI 6255	AI <0..79>, APFI 0
Functions	Start Trigger, Reference Trigger, Pause Trigger, Sample Clock, Convert Clock, Sample Clock Timebase
Source level	
AI <0..79>	±full scale
APFI <0..1>	±10 V
Resolution	10 bits, 1 in 1,024
Modes	Analog edge triggering, analog edge triggering with hysteresis, and analog window triggering
Bandwidth (–3 dB)	
AI <0..79>	3.4 MHz
APFI <0..1>	3.9 MHz
Accuracy	±1%
APFI <0..1> characteristics	
Input impedance	10 kΩ
Coupling	DC
Protection	
Power on	±30 V
Power off	±15 V

Analog Output

Number of channels	
NI 6250/6254	0
NI 6251/6255	2
NI 6259	4
DAC resolution	16 bits
DNL	±1 LSB
Monotonicity	16 bit guaranteed
Accuracy	Refer to the AO Absolute Accuracy Table
Maximum update rate	
1 channel	2.86 MS/s
2 channels	2.00 MS/s
3 channels	1.54 MS/s
4 channels	1.25 MS/s
Timing accuracy	50 ppm of sample rate
Timing resolution	50 ns
Output range	±10 V, ±5 V, ±external reference on APFI <0..1>
Output coupling	DC
Output impedance	0.2 Ω
Output current drive	±5 mA
Overdrive protection	±25 V
Overdrive current	20 mA
Power-on state	±5 mV ¹
Power-on glitch	1.5 V peak for 1.5 s
Output FIFO size	8,191 samples shared among channels used
Data transfers	
PCI/PCIe/PXI/PXIe devices	DMA (scatter-gather), interrupts, programmed I/O
USB devices	USB Signal Stream, programmed I/O

¹ For all USB-6251/6259 Screw Terminal devices, when powered on, the analog output signal is not defined until after USB configuration is complete.

AO waveform modes:

- Non-periodic waveform
- Periodic waveform regeneration mode from onboard FIFO
- Periodic waveform regeneration from host buffer including dynamic update

Settling time, full scale step

15 ppm (1 LSB).....2 μ s

Slew rate20 V/ μ s

Glitch energy at midscale transition, ± 10 V range

Magnitude10 mV

Duration1 μ s

External Reference

APFI <0..1> characteristics

Input impedance.....10 k Ω

Coupling.....DC

Protection

Power on..... ± 30 V

Power off ± 15 V

Range..... ± 11 V

Slew rate20 V/ μ s

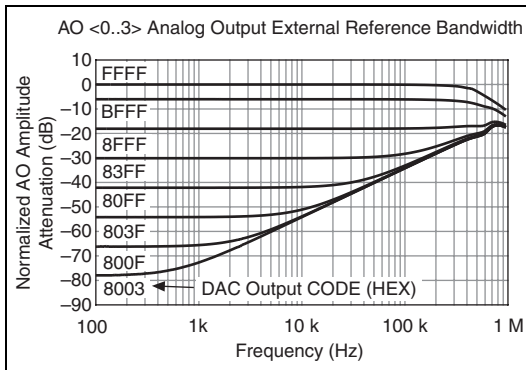

Calibration (AI and AO)

Recommended warm-up time15 minutes

Calibration interval.....2 years

AI Absolute Accuracy Table

Nominal Range		Residual Gain Error (ppm of Reading)	Gain Tempco (ppm/°C)	Reference Tempco	Residual Offset Error (ppm of Range)	Offset Tempco (ppm of Range/°C)	INL Error (ppm of Range)	Random Noise, σ (μ V rms)	Absolute Accuracy at Full Scale ¹ (μ V)	Sensitivity ² (μ V)
Positive Full Scale	Negative Full Scale									
10	-10	60	13	1	20	21	60	280	1,920	112.0
5	-5	70	13	1	20	21	60	140	1,010	56.0
2	-2	70	13	1	20	24	60	57	410	22.8
1	-1	80	13	1	20	27	60	32	220	12.8
0.5	-0.5	90	13	1	40	34	60	21	130	8.4
0.2	-0.2	130	13	1	80	55	60	16	74	6.4
0.1	-0.1	150	13	1	150	90	60	15	52	6.0

Accuracies listed are valid for up to two years from the device external calibration.

$$\text{AbsoluteAccuracy} = \text{Reading} \cdot (\text{GainError}) + \text{Range} \cdot (\text{OffsetError}) + \text{NoiseUncertainty}$$

$$\text{GainError} = \text{ResidualAI} \cdot \text{GainError} + \text{Gain} \cdot \text{Tempco} \cdot (\text{TempChangeFromLastInternalCal}) + \text{ReferenceTempco} \cdot (\text{TempChangeFromLastExternalCal})$$

$$\text{OffsetError} = \text{ResidualAI} \cdot \text{OffsetError} + \text{OffsetTempco} \cdot (\text{TempChangeFromLastInternalCal}) + \text{INL_Error}$$

$$\text{NoiseUncertainty} = \frac{\text{RandomNoise} \cdot 3}{\sqrt{100}} \quad \text{For a coverage factor of } 3 \sigma \text{ and averaging } 100 \text{ points.}$$

¹ Absolute accuracy at full scale on the analog input channels is determined using the following assumptions:

$$\text{TempChangeFromLastExternalCal} = 10 \text{ } ^\circ\text{C}$$

$$\text{TempChangeFromLastInternalCal} = 1 \text{ } ^\circ\text{C}$$

$$\text{number_of_readings} = 100$$

$$\text{CoverageFactor} = 3 \sigma$$

For example, on the 10 V range, the absolute accuracy at full scale is as follows:

$$\text{GainError} = 60 \text{ ppm} + 13 \text{ ppm} \cdot 1 + 1 \text{ ppm} \cdot 10 \quad \text{GainError} = 83 \text{ ppm}$$

$$\text{OffsetError} = 20 \text{ ppm} + 21 \text{ ppm} \cdot 1 + 60 \text{ ppm} \quad \text{OffsetError} = 101 \text{ ppm}$$

$$\text{NoiseUncertainty} = \frac{275 \text{ } \mu\text{V} \cdot 3}{\sqrt{100}} \quad \text{NoiseUncertainty} = 83 \text{ } \mu\text{V}$$

$$\text{AbsoluteAccuracy} = 10 \text{ V} \cdot (\text{GainError}) + 10 \text{ V} \cdot (\text{OffsetError}) + \text{NoiseUncertainty} \quad \text{AbsoluteAccuracy} = 1920 \text{ } \mu\text{V}$$

² Sensitivity is the smallest voltage change that can be detected. It is a function of noise.

AO Absolute Accuracy Table

Nominal Range		Residual Gain Error (ppm of Reading)	Gain Tempco (ppm/°C)	Reference Tempco	Residual Offset Error (ppm of Range)	Offset Tempco (ppm of Range/°C)	INL Error (ppm of Range)	Absolute Accuracy at Full Scale ¹ (µV)
Positive Full Scale	Negative Full Scale							
10	-10	75	17	1	40	2	64	2,080
5	-5	85	8	1	40	2	64	1,045

¹ Absolute Accuracy at full scale numbers is valid immediately following internal calibration and assumes the device is operating within 10 °C of the last external calibration. Accuracies listed are valid for up to two years from the device external calibration.

$$\begin{aligned} \text{Absolute Accuracy} &= \text{OutputValue} \cdot (\text{GainError}) + \text{Range} \cdot (\text{OffsetError}) \\ \text{GainError} &= \text{ResidualGainError} + \text{GainTempco} \cdot (\text{TempChangeFromLastInternalCal}) + \text{ReferenceTempco} \cdot (\text{TempChangeFromLastExternalCal}) \\ \text{OffsetError} &= \text{ResidualOffsetError} + \text{AOffsetTempco} \cdot (\text{TempChangeFromLastInternalCal}) + \text{INL_Error} \end{aligned}$$

Digital I/O/PFI

Static Characteristics

Number of channels	
NI 6250/6251/6255.....	24 total, 8 (P0.<0..7>), 16 (PFI <0..7>/P1, PFI <8..15>/P2)
NI 6254/6259.....	48 total, 32 (P0.<0..31>), 16 (PFI <0..7>/P1, PFI <8..15>/P2)
Ground reference.....	D GND
Direction control.....	Each terminal individually programmable as input or output
Pull-down resistor.....	50 kΩ typ, 20 kΩ min
Input voltage protection ¹	±20 V on up to two pins

Waveform Characteristics (Port 0 Only)

Terminals used	
NI 6250/6251/6255.....	Port 0 (P0.<0..7>)
NI 6254/6259.....	Port 0 (P0.<0..31>)
Port/sample size	
NI 6250/6251/6255.....	Up to 8 bits
NI 6254/6259.....	Up to 32 bits
Waveform generation (DO) FIFO ... 2,047 samples	
Waveform acquisition (DI) FIFO ... 2,047 samples	
DI Sample Clock frequency	
PCI/PCIe/PXI/PXIe devices.....	0 to 10 MHz ²
USB devices.....	0 to 1 MHz system dependent ²
DO Sample Clock frequency	
PCI/PCIe/PXI/PXIe devices	
Regenerate from FIFO.....	0 to 10 MHz
Streaming from memory.....	0 to 10 MHz system dependent ²
USB devices	
Regenerate from FIFO.....	0 to 10 MHz

Streaming from memory 0 to 1 MHz
system dependent²

Data transfers	
PCI/PCIe/PXI/PXIe devices.....	DMA (scatter-gather), interrupts, programmed I/O
USB devices.....	USB Signal Stream, programmed I/O
DO or DI Sample	
Clock source ³	Any PFI, RTSI, AI Sample or Convert Clock, AO Sample Clock, Ctr <i>n</i> Internal Output, and many other signals

PFI/Port 1/Port 2 Functionality

Functionality.....	Static digital input, static digital output, timing input, timing output
Timing output sources.....	Many AI, AO, counter, DI, DO timing signals
Debounce filter settings.....	125 ns, 6.425 μs, 2.56 ms, disable; high and low transitions; selectable per input

Recommended Operation Conditions⁴

Level	Min	Max
Input high voltage (V _{IH})	2.2 V	5.25 V
Input low voltage (V _{IL})	0 V	0.8 V
Output high current (I _{OH}) P0.<0..31> PFI <0..15>/P1/P2	—	–24 mA –16 mA
Output low current (I _{OL}) P0.<0..31> PFI <0..15>/P1/P2	—	24 mA 16 mA

¹ Stresses beyond those listed under *Input voltage protection* may cause permanent damage to the device.

² Performance can be dependent on bus latency and volume of bus activity.

³ The digital subsystem does not have its own dedicated internal timing engine. Therefore, a sample clock must be provided from another subsystem on the device or an external source.

⁴ On earlier versions of the USB-6251 Screw Terminal (part numbers 194929A/B/C-0x) and the USB-6259 Screw Terminal (part numbers 194021B/C-0x), the digital I/O characteristics of P0.<16..31> match the characteristics of PFI <0..15>. Refer to the November 2006 version of this document (part number 371291G-01) for more details.

Electrical Characteristics

Level	Min	Max
Positive-going threshold (VT+)	—	2.2 V
Negative-going threshold (VT-)	0.8 V	—
Delta VT hysteresis (VT+ – VT-)	0.2 V	—
I _{IL} input low current (V _{in} = 0 V)	—	-10 μA
I _{IH} input high current (V _{in} = 5 V)	—	250 μA

Digital I/O Characteristics¹

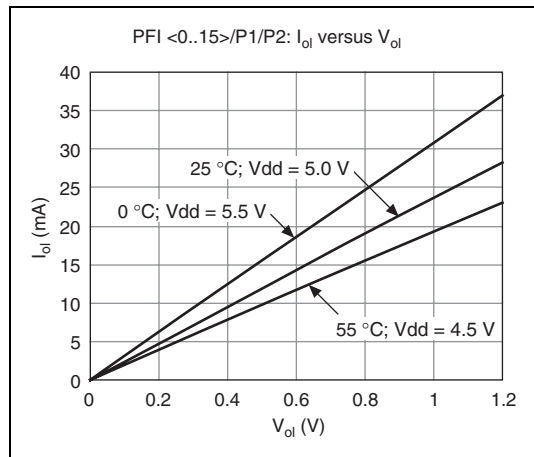
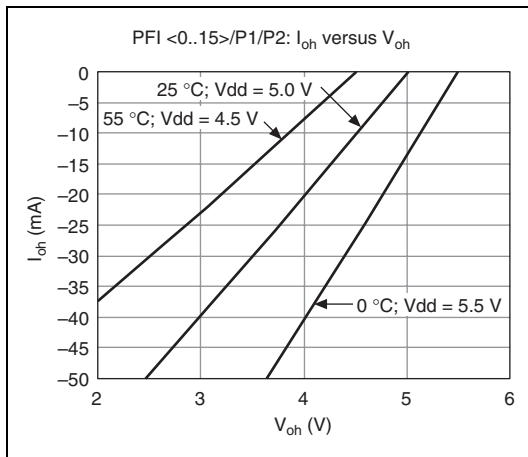
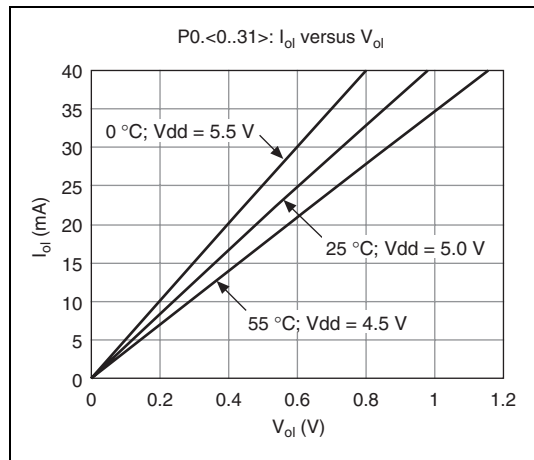
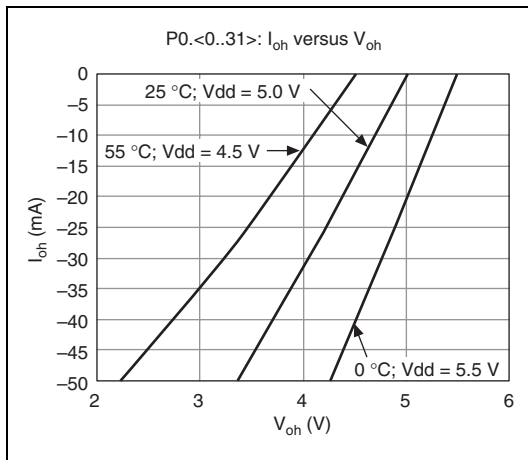

¹ On earlier versions of the USB-6251 Screw Terminal (part numbers 194929A/B/C-0x) and the USB-6259 Screw Terminal (part numbers 194021B/C-0x), the digital I/O characteristics of P0.<16..31> match the characteristics of PFI <0..15>. Refer to the November 2006 version of this document (part number 371291G-01) for more details.

General-Purpose Counter/Timers

Number of counter/timers	2
Resolution	32 bits
Counter measurements	Edge counting, pulse, semi-period, period, two-edge separation
Position measurements	X1, X2, X4 quadrature encoding with Channel Z reloading; two-pulse encoding
Output applications	Pulse, pulse train with dynamic updates, frequency division, equivalent time sampling
Internal base clocks	80 MHz, 20 MHz, 0.1 MHz
External base clock frequency	0 MHz to 20 MHz
Base clock accuracy	50 ppm
Inputs	Gate, Source, HW_Arm, Aux, A, B, Z, Up_Down
Routing options for inputs	Any PFI, RTSI, PXI_TRIG, PXI_STAR, analog trigger, many internal signals
FIFO	2 samples
Data transfers	
PCI/PCIe/PXI/PXIe devices	Dedicated scatter-gather DMA controller for each counter/timer; interrupts, programmed I/O
USB devices	USB Signal Stream, programmed I/O

Frequency Generator

Number of channels	1
Base clocks	10 MHz, 100 kHz
Divisors	1 to 16
Base clock accuracy	50 ppm
Output can be available on any PFI or RTSI terminal.	

Phase-Locked Loop (PLL)

Number of PLLs	1
Reference signal	PXI_STAR, PXI_CLK10, RTSI <0..7>
Output of PLL	80 MHz Timebase; other signals derived from 80 MHz Timebase including 20 MHz and 100 kHz Timebases

External Digital Triggers

Source	Any PFI, RTSI, PXI_TRIG, PXI_STAR
Polarity	Software-selectable for most signals
Analog input function	Start Trigger, Reference Trigger, Pause Trigger, Sample Clock, Convert Clock, Sample Clock Timebase
Analog output function	Start Trigger, Pause Trigger, Sample Clock, Sample Clock Timebase
Counter/timer functions	Gate, Source, HW_Arm, Aux, A, B, Z, Up_Down
Digital waveform generation (DO) function	Sample Clock
Digital waveform acquisition (DI) function	Sample Clock

Device-To-Device Trigger Bus

PCI/PCIe devices	RTSI <0..7> ¹
PXI/PXIe devices	PXI_TRIG <0..7>, PXI_STAR
USB devices	None
Output selections	10 MHz Clock; frequency generator output; many internal signals
Debounce filter settings	125 ns, 6.425 μs, 2.56 ms, disable; high and low transitions; selectable per input

Bus Interface

PCI/PXI devices	3.3 V or 5 V signal environment
PCIe devices	
Form factor	x1 PCI Express, specification v1.0a compliant
Slot compatibility	x1, x4, x8, and x16 PCI Express slots ²
PXIe devices	
Form factor	x1 PXI Express peripheral module, specification rev 1.0 compliant
Slot compatibility	x1 and x4 PXI Express or PXI Express hybrid slots
USB devices	USB 2.0 Hi-Speed or full-speed ^{3,4}
DMA channels (PCI/PCIe/PXI/PXIe devices)	6, analog input, analog output, digital input, digital output, counter/timer 0, counter/timer 1

USB Signal Stream (USB devices)	4, can be used for analog input, analog output, digital input, digital output, counter/timer 0, counter/timer 1
---------------------------------------	---

All PXI-625x devices support one of the following features:

- May be installed in PXI Express hybrid slots
- Or, may be used to control SCXI in PXI/SCXI combo chassis

Table 1. PXI/SCXI Combo and PXI Express Chassis Compatibility

M Series Device	M Series Part Number	SCXI Control in PXI/SCXI Combo Chassis	PXI Express Hybrid Slot Compatible
PXI-6250	191325D-04/ 191325E-04L	No	Yes
PXI-6251	191325D-03/ 191325E-03L	No	Yes
	191325D-13/ 191325E-13L	Yes	No
PXI-6254	191325D-02/ 191325E-03L	No	Yes
PXI-6255	193618A-01	No	Yes
PXI-6259	191325D-01/ 191325E-01L	No	Yes
	191325D-11/ 191325E-11L	Yes	No
Earlier versions of PXI-6251/ 6254/6259	191325C-0x 191325B-0x	Yes	No

All NI PXIe-625x devices may be installed in PXI Express slots or PXI Express hybrid slots.

¹ In other sections of this document, *RTSI* refers to *RTSI <0..7>* for PCI/PCIe devices or *PXI_TRIG <0..7>* for PXI/PXIe devices.

² Some motherboards reserve the x16 slot for graphics use. For PCI Express guidelines, refer to ni.com/pciexpress.

³ If you are using a USB M Series device in full-speed mode, device performance will be lower and you will not be able to achieve maximum sampling/update rates.

⁴ Operating on a full-speed bus may result in lower high-speed full-speed performance.

Power Requirements

Current draw from bus during no-load condition¹

PCI/PXI devices	
+5 V	0.03 A
+3.3 V	0.725 A
+12 V	0.35 A
PCIe devices	
+3.3 V	0.925 A
+12 V	0.35 A
PXIe devices	
+3.3 V	0.45 A
+12 V	0.5 A

Current draw from bus during AI and AO overvoltage condition²

PCI/PXI devices	
+5 V	0.03 A
+3.3 V	1.2 A
+12 V	0.38 A
PCIe devices	
+3.3 V	1.4 A
+12 V	0.38 A
PXIe devices	
+3.3 V	0.48 A
+12 V	0.71 A



Caution USB-625x devices *must* be powered with NI offered AC adapter or a National Electric Code (NEC) Class 2 DC source that meets the power requirements for the device and has appropriate safety certification marks for country of use.

USB power supply requirements 11 to 30 VDC, 20 W, locking or non-locking power jack with 0.080" diameter center pin, 5/16–32 thread for locking collars

Power Limits



Caution Exceeding the power limits may cause unpredictable behavior by the device and/or PC/chassis.

PCI devices

+5 V terminal (connector 0).....	1 A max ³
+5 V terminal (connector 1).....	1 A max ³

PCIe devices

Without disk drive power connector installed	
+5 V terminals combined	0.35 A max ³
P0/PFI/P1/P2 and +5 V terminals combined	
	0.39 A max
With disk drive power connector installed	
+5 V terminal (connector 0) ...	1 A max ³
+5 V terminal (connector 1) ...	1 A max ³
P0/PFI/P1/P2 combined	0.39 A max

PXI/PXIe devices

+5 V terminal (connector 0).....	1 A max ³
+5 V terminal (connector 1).....	1 A max ³
P0/PFI/P1/P2 and +5 V terminals combined.....	
	2 A max

USB devices

+5 V terminal.....	1 A max ³
P0/PFI/P1/P2 and +5 V terminals combined.....	
	2 A max
Power supply fuse.....	2 A, 250 V

Physical Requirements

Printed circuit board dimensions

NI PCI-6250/6251/6254/6255/6259	
	9.7 × 15.5 cm (3.8 × 6.1 in.)
NI PCIe-6251/6259	
	9.9 × 16.8 cm (3.9 × 6.6 in.) (half-length)
NI PXI/PXIe-6250/6251/6254/6255/6259	
	Standard 3U PXI

¹ Does not include P0/PFI/P1/P2 and +5 V terminals.

² Does not include P0/PFI/P1/P2 and +5 V terminals.

³ Has a self-resetting fuse that opens when current exceeds this specification.

Enclosure dimensions (includes connectors)	
NI USB-6251/6255/6259	
Screw Terminal.....	26.67 × 17.09 × 4.45 cm (10.5 × 6.73 × 1.75 in.)
NI USB-6251/6259 BNC.....	28.6 × 17 × 6.9 cm (11.25 × 6.7 × 2.7 in.)
NI USB-6251/6255/6259	
Mass Termination	18.8 × 17.09 × 4.45 cm (7.4 × 6.73 × 1.75 in.)
NI USB-6251/6255/6259	
OEM.....	Refer to the <i>NI USB-622x/625x OEM User Guide</i>

Weight	
NI PCI-6250.....	142 g (5 oz)
NI PCI-6251.....	149 g (5.2 oz)
NI PCI-6254.....	152 g (5.3 oz)
NI PCI-6255.....	164 g (5.8 oz)
NI PCI-6259.....	162 g (5.6 oz)
NI PCIe-6251.....	161 g (5.7 oz)
NI PCIe-6259.....	175 g (6.1 oz)
NI PXI-6250.....	212 g (7.5 oz)
NI PXI-6251/6254.....	222 g (7.8 oz)
NI PXI-6255.....	236 g (8.3 oz)
NI PXI-6259.....	233 g (8.2 oz)
NI PXIe-6251.....	208 g (7.3 oz)
NI PXIe-6259.....	221 g (7.8 oz)
NI USB-6251 Screw Terminal ...	1.2 kg (2 lb 10 oz)
NI USB-6255/6259	
Screw Terminal.....	1.24 kg (2 lb 11 oz)
NI USB-6251/6255/6259	
Mass Termination	816 g (1 lb 12.8 oz)
NI USB-6251 OEM	140 g (4.9 oz)
NI USB-6255/6259 OEM	172 g (6.1 oz)

I/O connector	
NI PCI/PCIe/PXI/PXIe-6250/	
6251	1 68-pin VHDCI
NI PCI/PCIe/PXI/PXIe-6254/	
6255/6259.....	2 68-pin VHDCI
NI USB-6251 Screw Terminal ...	64 screw terminals
NI USB-6255/6259	
Screw Terminal	128 screw terminals
NI USB-6251 BNC	21 BNCs and 30 screw terminals
NI USB-6259 BNC	32 BNCs and 60 screw terminals
NI USB-6251	
Mass Termination.....	1 68-pin SCSI
NI USB-6255/6259	
Mass Termination.....	2 68-pin SCSI

Disk drive power connector	
(PCIe devices).....	Standard ATX peripheral connector (not serial ATA)

USB-6251/6255/6259 Screw Terminal/USB-6251/6259 BNC screw terminal wiring	16–28 AWG
--	-----------

Maximum Working Voltage¹

NI 6250/6251/6254/6255/6259	
Channel-to-earth	11 V, Measurement Category I



Caution Do *not* use for measurements within
Categories II, III, or IV.

Environmental

Operating temperature	
PCI/PXI/PXIe devices.....	0 to 55 °C
PCIe devices.....	0 to 50 °C
USB devices	0 to 45 °C
Storage temperature	–20 to 70 °C
Humidity	10 to 90% RH, noncondensing
Maximum altitude.....	2,000 m
Pollution Degree	
(indoor use only).....	2

¹ *Maximum working voltage* refers to the signal voltage plus the common-mode voltage.

Shock and Vibration (PXI/PXIe Devices Only)

Operational shock	30 g peak, half-sine, 11 ms pulse (Tested in accordance with IEC-60068-2-27. Test profile developed in accordance with MIL-PRF-28800F.)
Random vibration	
Operating	5 to 500 Hz, 0.3 g_{rms}
Nonoperating	5 to 500 Hz, 2.4 g_{rms} (Tested in accordance with IEC-60068-2-64. Nonoperating test profile exceeds the requirements of MIL-PRF-28800F, Class 3.)

Safety

This product is designed to meet the requirements of the following standards of safety for electrical equipment for measurement, control, and laboratory use:

- IEC 61010-1, EN 61010-1
- UL 61010-1, CSA 61010-1



Note For UL and other safety certifications, refer to the product label or visit ni.com/certification, search by model number or product line, and click the appropriate link in the Certification column.

Electromagnetic Compatibility

This product is designed to meet the requirements of the following standards of EMC for electrical equipment for measurement, control, and laboratory use:

- EN 61326 EMC requirements; Minimum Immunity
- EN 55011 Emissions; Group 1, Class A
- CE, C-Tick, ICES, and FCC Part 15 Emissions; Class A



Note For EMC compliance, operate this device according to product documentation.

CE Compliance

This product meets the essential requirements of applicable European Directives, as amended for CE marking, as follows:

- 73/23/EEC; Low-Voltage Directive (safety)
- 89/336/EEC; Electromagnetic Compatibility Directive (EMC)



Note Refer to the Declaration of Conformity (DoC) for this product for any additional regulatory compliance information. To obtain the DoC for this product, visit ni.com/certification, search by model number or product line, and click the appropriate link in the Certification column.

Environmental Management

National Instruments is committed to designing and manufacturing products in an environmentally responsible manner. NI recognizes that eliminating certain hazardous substances from our products is beneficial not only to the environment but also to NI customers.

For additional environmental information, refer to the *NI and the Environment* Web page at ni.com/environment. This page contains the environmental regulations and directives with which NI complies, as well as any other environmental information not included in this document.

Waste Electrical and Electronic Equipment (WEEE)



EU Customers At the end of their life cycle, all products *must* be sent to a WEEE recycling center. For more information about WEEE recycling centers and National Instruments WEEE initiatives, visit ni.com/environment/weee.htm.

电子信息产品污染控制管理办法（中国 RoHS）



中国客户 National Instruments 符合中国电子信息产品中限制使用某些有害物质指令 (RoHS)。关于 National Instruments 中国 RoHS 合规性信息, 请登录 ni.com/environment/rohs_china。(For information about China RoHS compliance, go to ni.com/environment/rohs_china.)

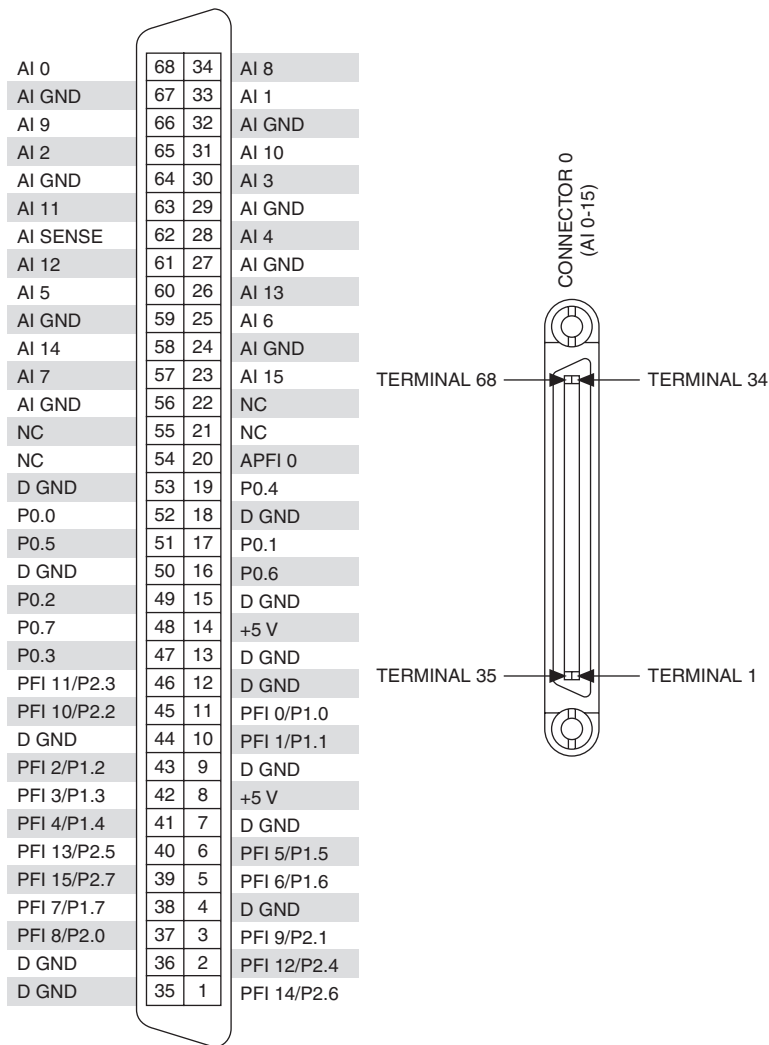

NC = No Connect

Figure 1. NI PCI/PXI-6250 Pinout

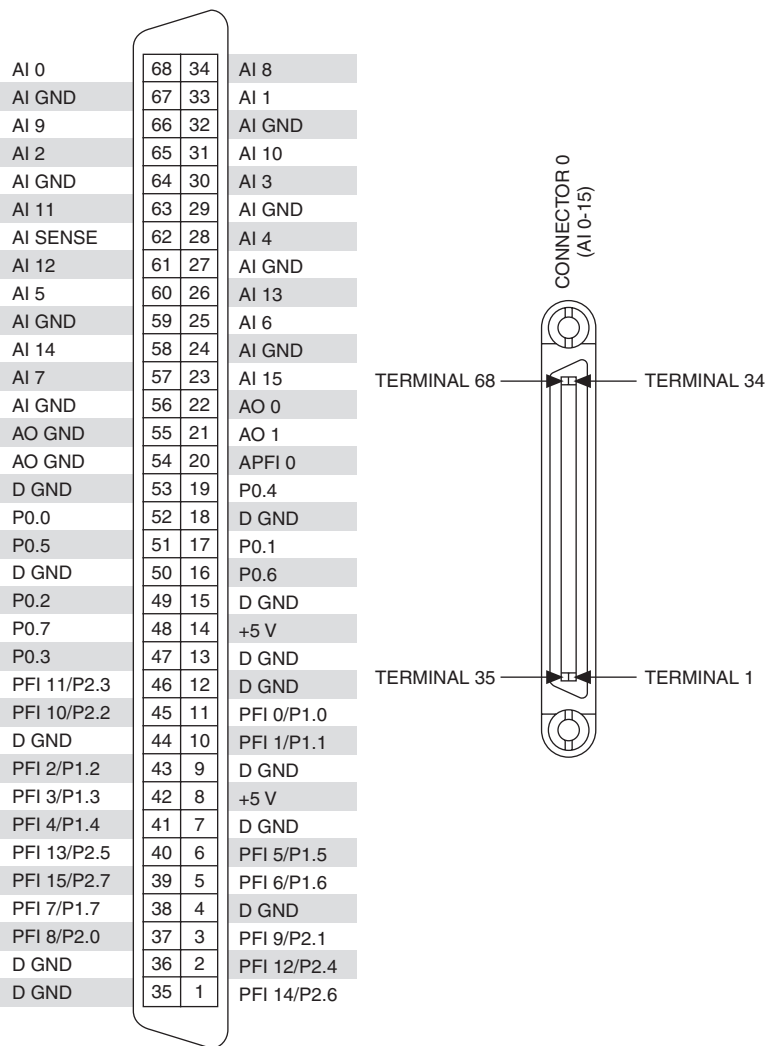

Figure 2. NI PCI/PCIe/PXI/PXIe-6251 Pinout

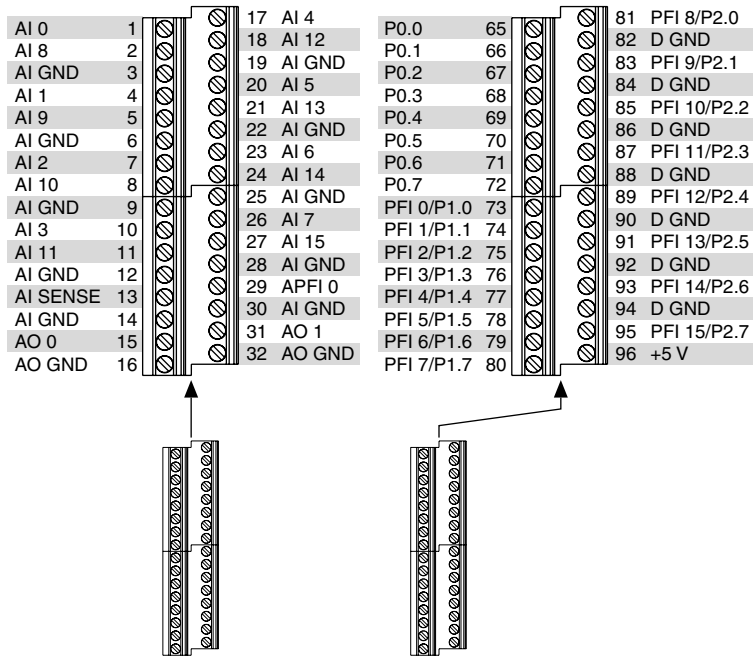

Figure 3. NI USB-6251 Screw Terminal Pinout

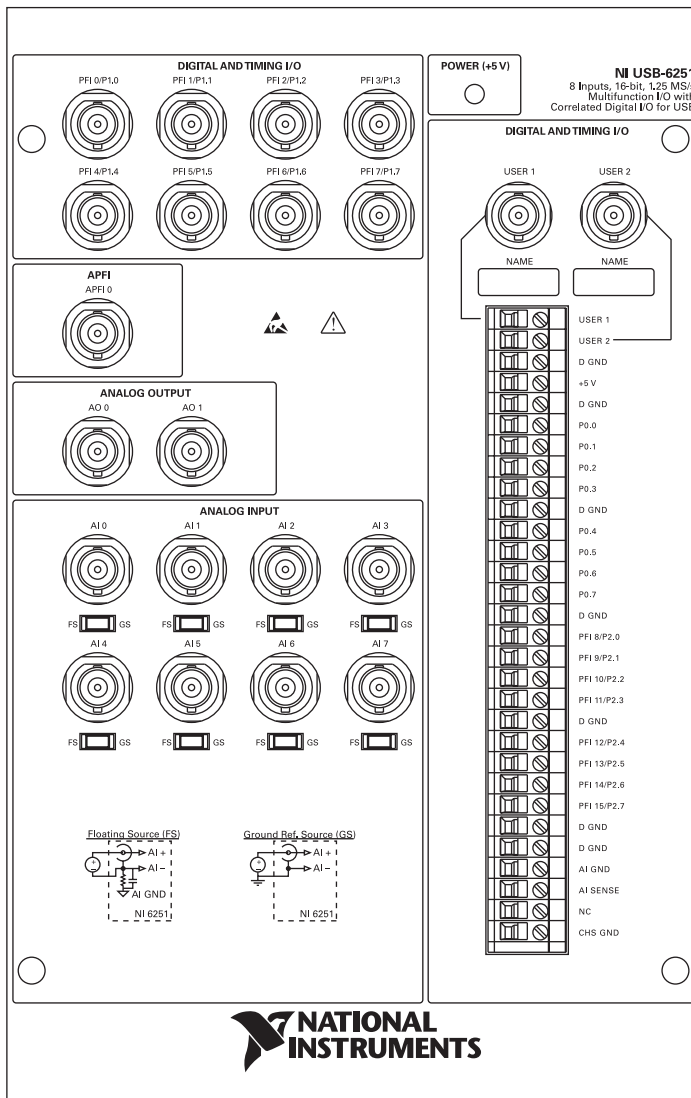

Figure 4. NI USB-6251 BNC Front Panel and Pinout

AI 8	34	68	AI 0
AI 1	33	67	AI GND
AI GND	32	66	AI 9
AI 10	31	65	AI 2
AI 3	30	64	AI GND
AI GND	29	63	AI 11
AI 4	28	62	AI SENSE
AI GND	27	61	AI 12
AI 13	26	60	AI 5
AI 6	25	59	AI GND
AI GND	24	58	AI 14
AI 15	23	57	AI 7
AO 0	22	56	AI GND
AO 1	21	55	AO GND
APFI 0	20	54	AO GND
P0.4	19	53	D GND
D GND	18	52	P0.0
P0.1	17	51	P0.5
P0.6	16	50	D GND
D GND	15	49	P0.2
+5 V	14	48	P0.7
D GND	13	47	P0.3
D GND	12	46	PFI 11/P2.3
PFI 0/P1.0	11	45	PFI 10/P2.2
PFI 1/P1.1	10	44	D GND
D GND	9	43	PFI 2/P1.2
+5 V	8	42	PFI 3/P1.3
D GND	7	41	PFI 4/P1.4
PFI 5/P1.5	6	40	PFI 13/P2.5
PFI 6/P1.6	5	39	PFI 15/P2.7
D GND	4	38	PFI 7/P1.7
PFI 9/P2.1	3	37	PFI 8/P2.0
PFI 12/P2.4	2	36	D GND
PFI 14/P2.6	1	35	D GND

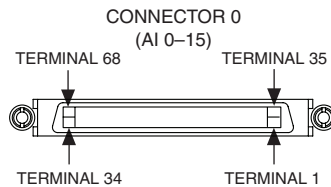

Figure 5. NI USB-6251 Mass Termination Pinout

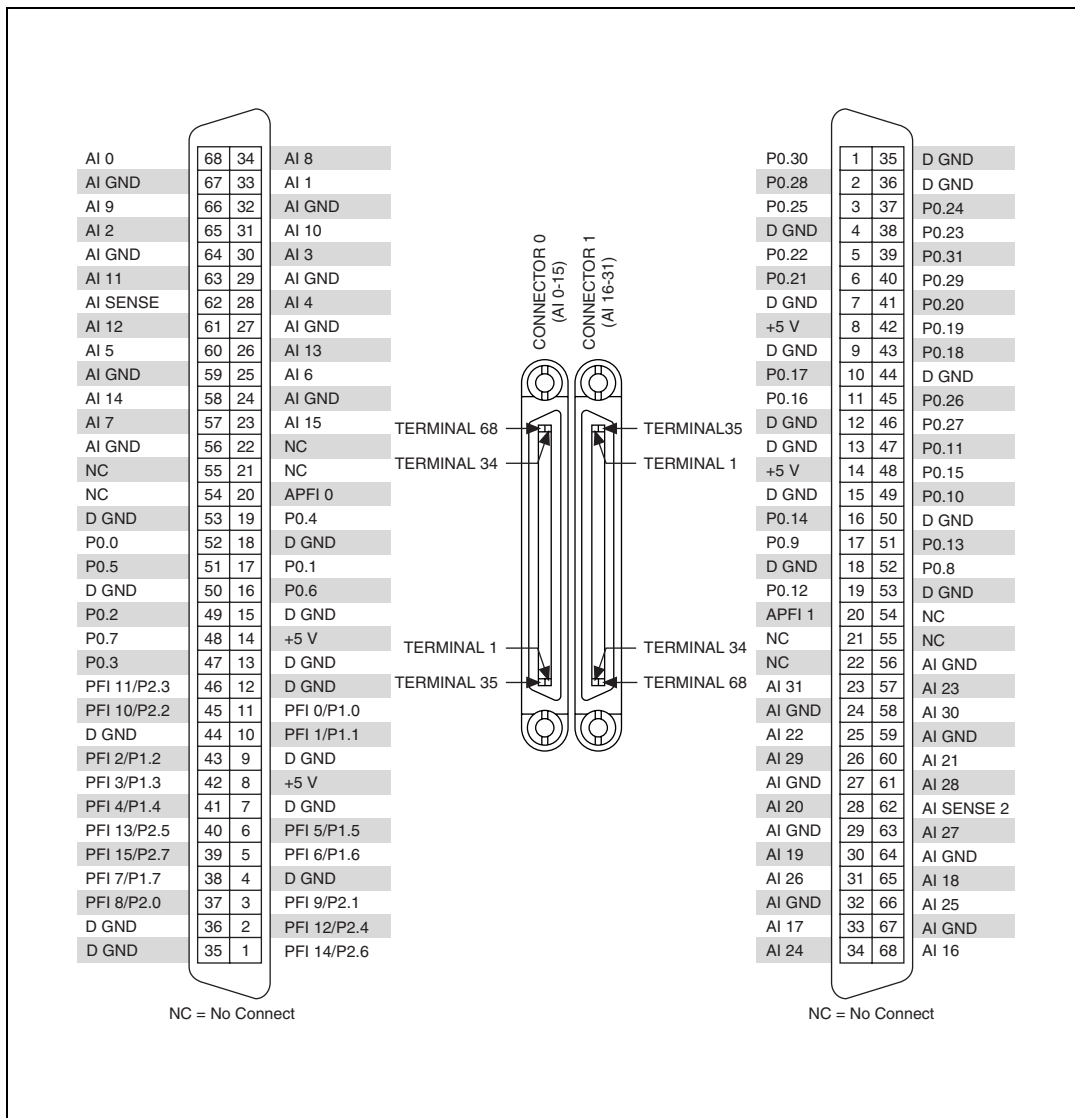

Figure 6. NI PCI/PXI-6254 Pinout

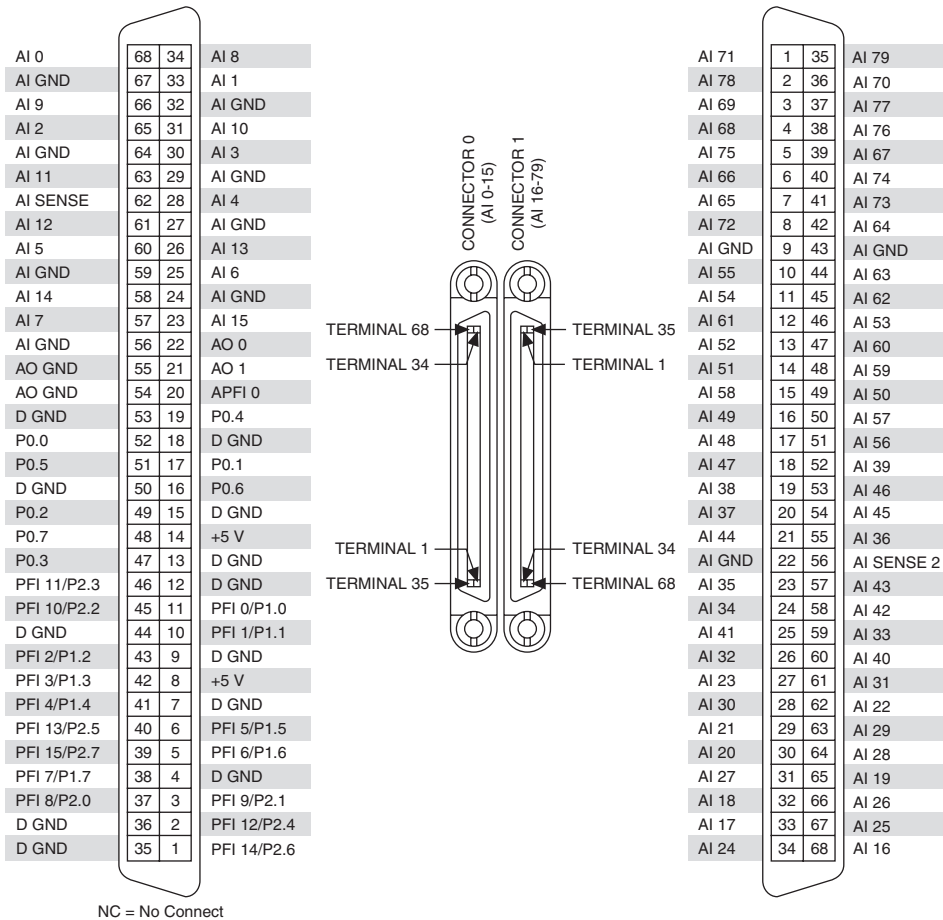

Figure 7. NI PCI/PXI-6255 Pinout

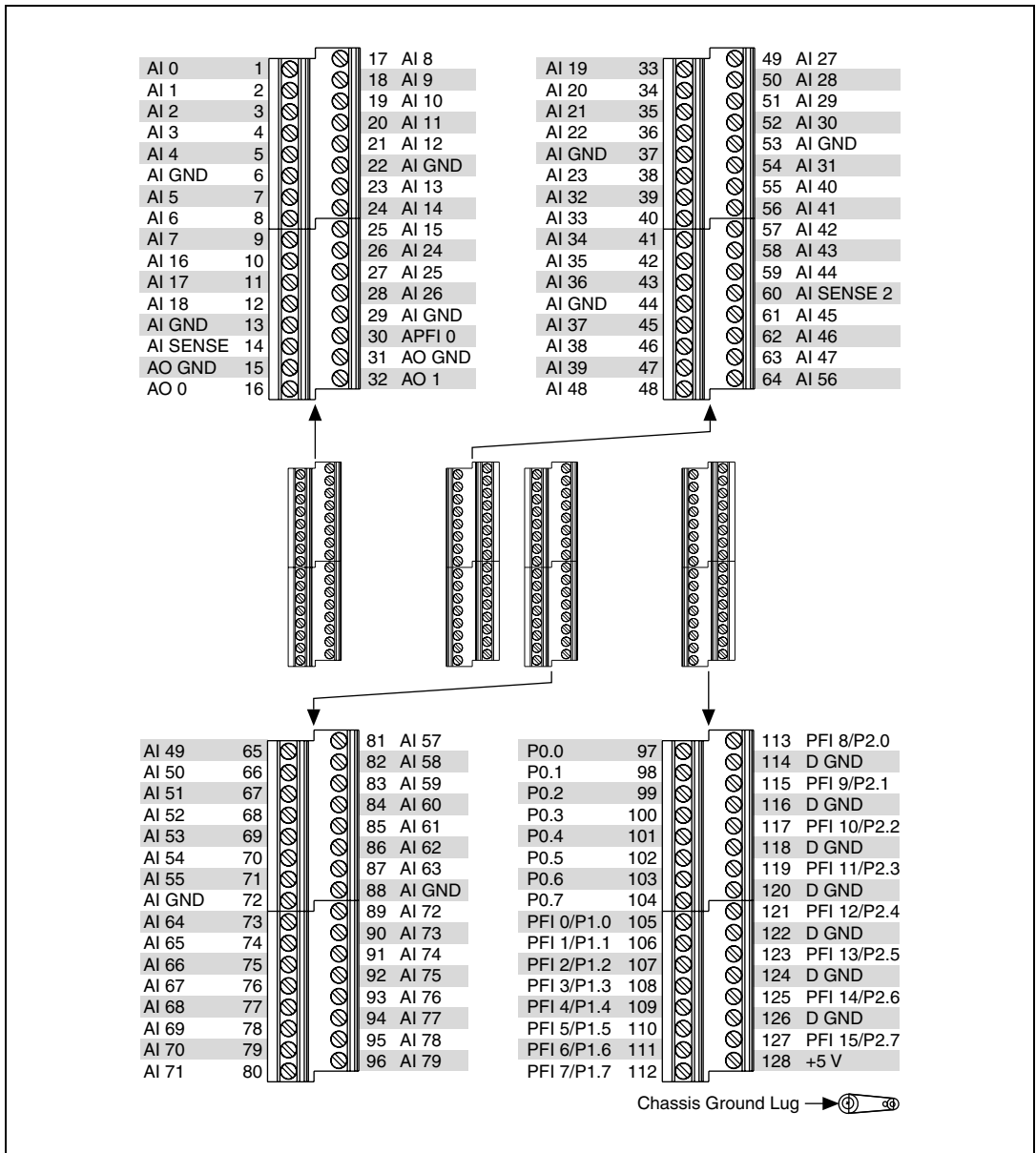

Figure 8. NI USB-6255 Screw Terminal Pinout

AI 24	34	68	AI 16	AI 8	34	68	AI 0
AI 17	33	67	AI 25	AI 1	33	67	AI GND
AI 18	32	66	AI 26	AI GND	32	66	AI 9
AI 27	31	65	AI 19	AI 10	31	65	AI 2
AI 20	30	64	AI 28	AI 3	30	64	AI GND
AI 21	29	63	AI 29	AI GND	29	63	AI 11
AI 30	28	62	AI 22	AI 4	28	62	AI SENSE
AI 23	27	61	AI 31	AI GND	27	61	AI 12
AI 32	26	60	AI 40	AI 13	26	60	AI 5
AI 41	25	59	AI 33	AI 6	25	59	AI GND
AI 34	24	58	AI 42	AI GND	24	58	AI 14
AI 35	23	57	AI 43	AI 15	23	57	AI 7
AI GND	22	56	AI SENSE 2	AO 0	22	56	AI GND
AI 44	21	55	AI 36	AO 1	21	55	AO GND
AI 37	20	54	AI 45	APFI 0	20	54	AO GND
AI 38	19	53	AI 46	P0.4	19	53	D GND
AI 47	18	52	AI 39	D GND	18	52	P0.0
AI 48	17	51	AI 56	P0.1	17	51	P0.5
AI 49	16	50	AI 57	P0.6	16	50	D GND
AI 58	15	49	AI 50	D GND	15	49	P0.2
AI 51	14	48	AI 59	+5 V	14	48	P0.7
AI 52	13	47	AI 60	D GND	13	47	P0.3
AI 61	12	46	AI 53	D GND	12	46	PFI 11/P2.3
AI 54	11	45	AI 62	PFI 0/P1.0	11	45	PFI 10/P2.2
AI 55	10	44	AI 63	PFI 1/P1.1	10	44	D GND
AI GND	9	43	AI GND	D GND	9	43	PFI 2/P1.2
AI 72	8	42	AI 64	+5 V	8	42	PFI 3/P1.3
AI 65	7	41	AI 73	D GND	7	41	PFI 4/P1.4
AI 66	6	40	AI 74	PFI 5/P1.5	6	40	PFI 13/P2.5
AI 75	5	39	AI 67	PFI 6/P1.6	5	39	PFI 15/P2.7
AI 68	4	38	AI 76	D GND	4	38	PFI 7/P1.7
AI 69	3	37	AI 77	PFI 9/P2.1	3	37	PFI 8/P2.0
AI 78	2	36	AI 70	PFI 12/P2.4	2	36	D GND
AI 71	1	35	AI 79	PFI 14/P2.6	1	35	D GND

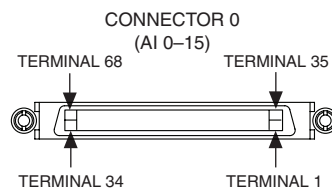
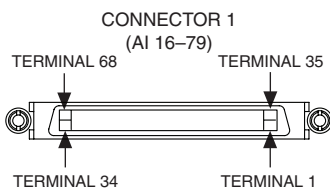

Figure 9. NI USB-6255 Mass Termination Pinout

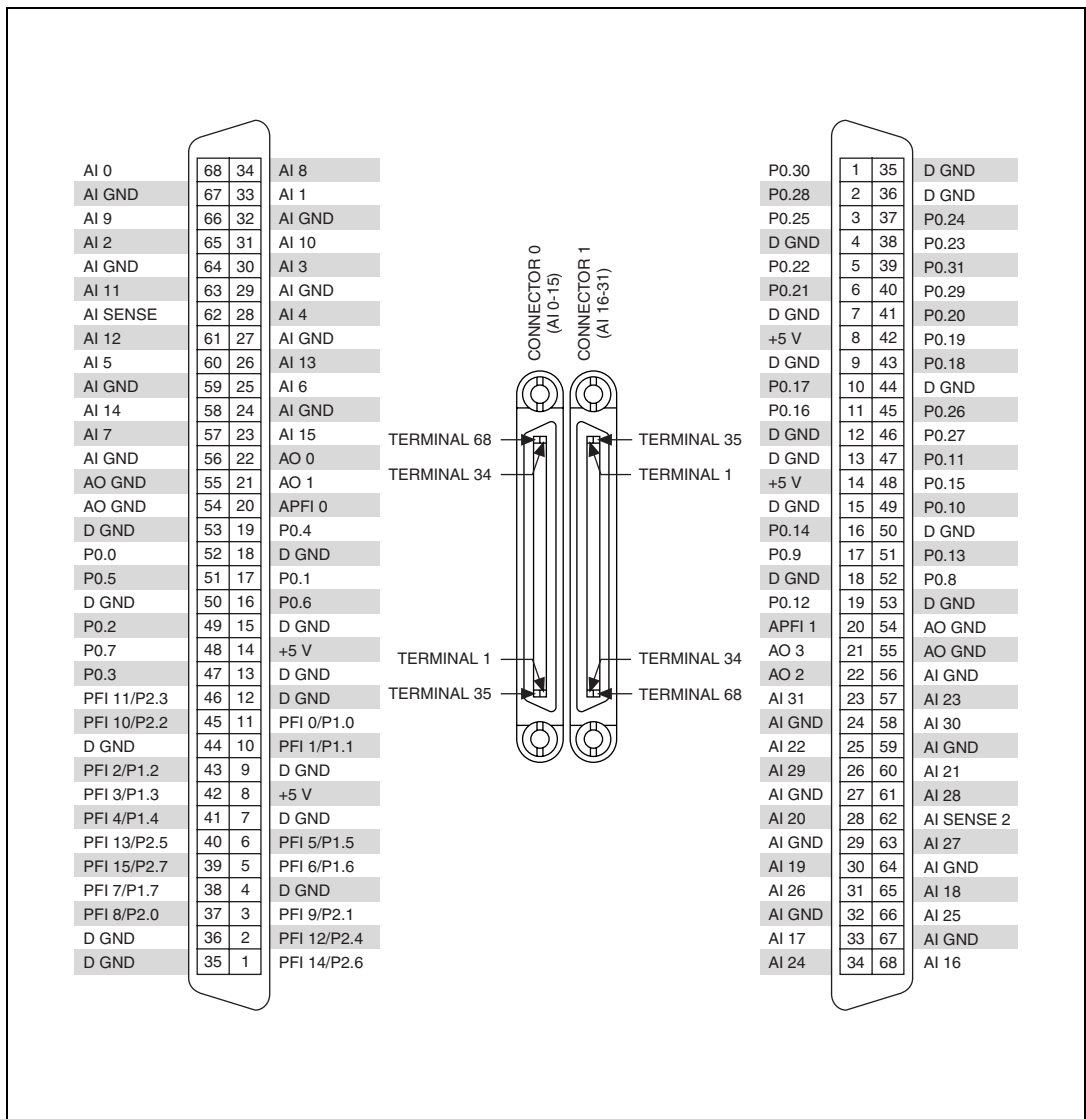

Figure 10. NI PCI/PCIe/PXI/PXIe-6259 Pinout

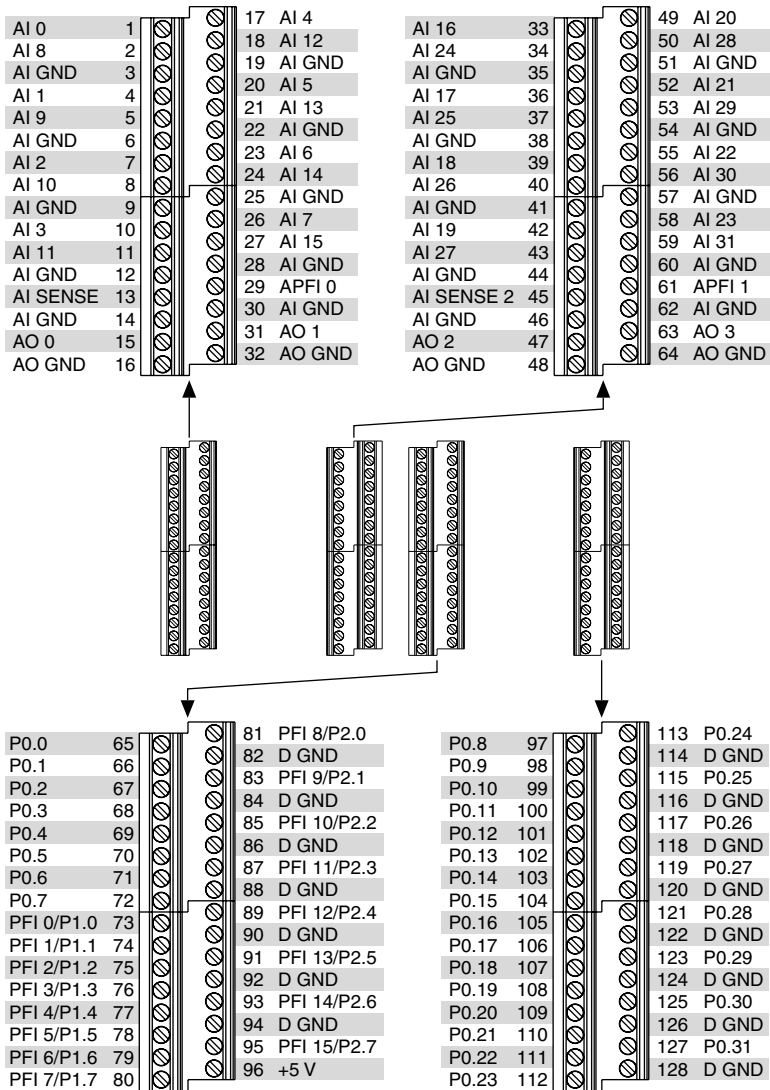

Figure 11. NI USB-6259 Screw Terminal Pinout

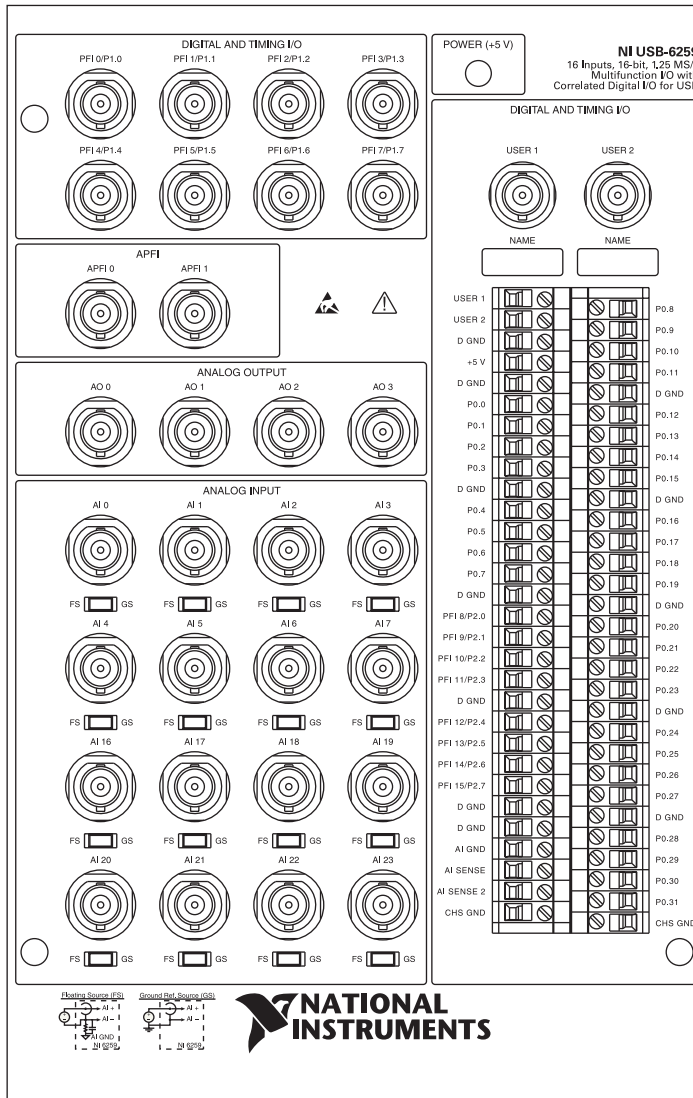

Figure 12. NI USB-6259 BNC Front Panel and Pinout

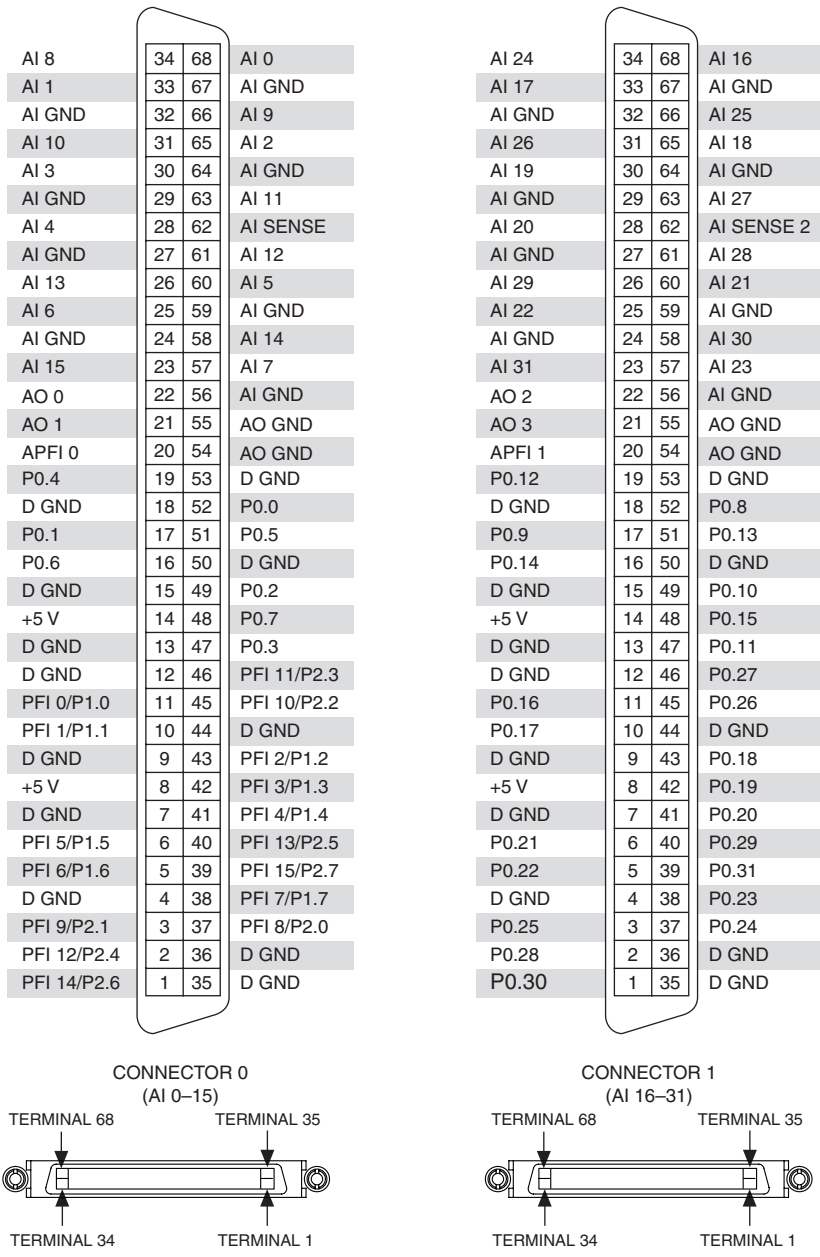

Figure 13. NI USB-6259 Mass Termination Pinout

National Instruments, NI, ni.com, and LabVIEW are trademarks of National Instruments Corporation. Refer to the *Terms of Use* section on ni.com/legal for more information about National Instruments trademarks. Other product and company names mentioned herein are trademarks or trade names of their respective companies. For patents covering National Instruments products, refer to the appropriate location: **Help>Patents** in your software, the `patents.txt` file on your CD, or ni.com/patents.