

N8LP LP-200 Dummy Load/Wattmeter Assembly and User Manual

© Copyright 2006, TelePost Inc.

1 Introduction

LP-200 Assembly and Operations Manual

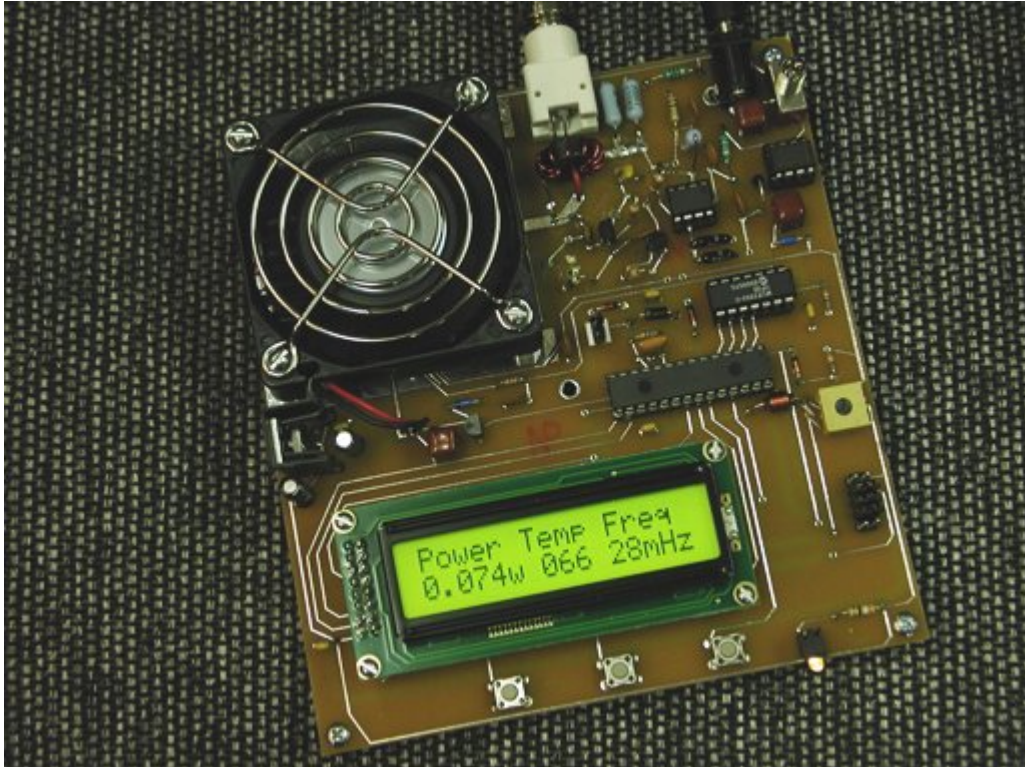

TelePost Inc. (c) 2005, 2006
Manual Revision 1.6

1.1 Assembly

LP-200 Parts List

1	U1	16F876
1	U2	LM7805T
1	U3	MCP3302
1	U4	TLC271ACP
1	U5	LM34DZ
1	U6	MAX6250
3	L1-3	1 mH choke
3	SW1-3	Tactile Switches – 6mm
4	C1-2, 7, 17	0.1 uF, marked 104 (only three supplied for 30W version)
4	C3, 5, 10, 19	10 uF
1	C4	0.33 uF, marked 334
4	C9, 12, 18, 21	1 uF, marked 105
3	C6, 13, 14	0.01 uF, marked 103 - .2" lead spacing
4	C11, 16, 20, 22	0.01 uF, marked 103 - .1" lead spacing
2	C8, 15	330 pF, marked 331
1	D1	1N4148, small glass pkg
1	D2	LED
1	D3	1N4001, larger black pkg
1	D4	HSMS-2805 Schottky dual diode (SMD)
4	D5, 7-9	1N5711, small glass pkg (only three supplied for 30W version)
1	Q1	2N7000 (not supplied for 30W version)
3	Q2-4	2N3904
1	LCD1	CFAH1602A-YYH-JP
1	J1	LCD Socket
1	J2	DC jack
1	J4	BNC jack
1	J5	10 pos programming header
1	Y1	20 MHz resonator
2	R1, 10	1M , 1/8W 1%, Br-BI-BI-yel
2	R2, 6	10 k 1/8W 5%, Br-BI-Or
2	R11, 33	10 k 1/8W 1%, Br-BI-BI-Rd
1	R3	390 1/4W, Or-Wh-Br
2	R4,R5	110 , 3/4W 1%, Br-Br-BI-BI
3	R7, 34, 38	22 k , 1/8W, Rd-Rd-Or
1	R8	20 k pot
1	R9	150 k , 1%, Br-Gr-BI-Or
3	R12, 13, 39	1 k , 1/8W 5%, Br-BI-Rd
18	R15-32	100 , 3W 5%,
3	R14, 35, 37	270 , 1/4W, Rd-Viol-Br
2	R36, 40	47 , 1/8W, Yel-Viol-BI
1	T1	FT50-61
1	SW1	Power Switch
1	Fan & guard	(not supplied for 30W version)
1	TO-220 Heat sink	
1	PCB	
1	Bottom plate	
1	2-pin header	
3	(3) Jumpers	
2	(2) 8-pin sockets	
1	14-pin socket	
1	28-pin socket	
1	16-pin LCD header	mounts on LCD board
1	DC power pigtail w/connector	
12	4-40 x 1/4" screws	(only 8 supplied for 30W version)
4	4-40 x 3/4" screws	(not supplied for 30W version)
4	4-40 x 1/2" hex spacers	
4	4-40 x 1/2" round spacers (not supplied for 30W version)	
4	2-56 x 1/4" screws	
2	2-56 x 1/2" spacers	

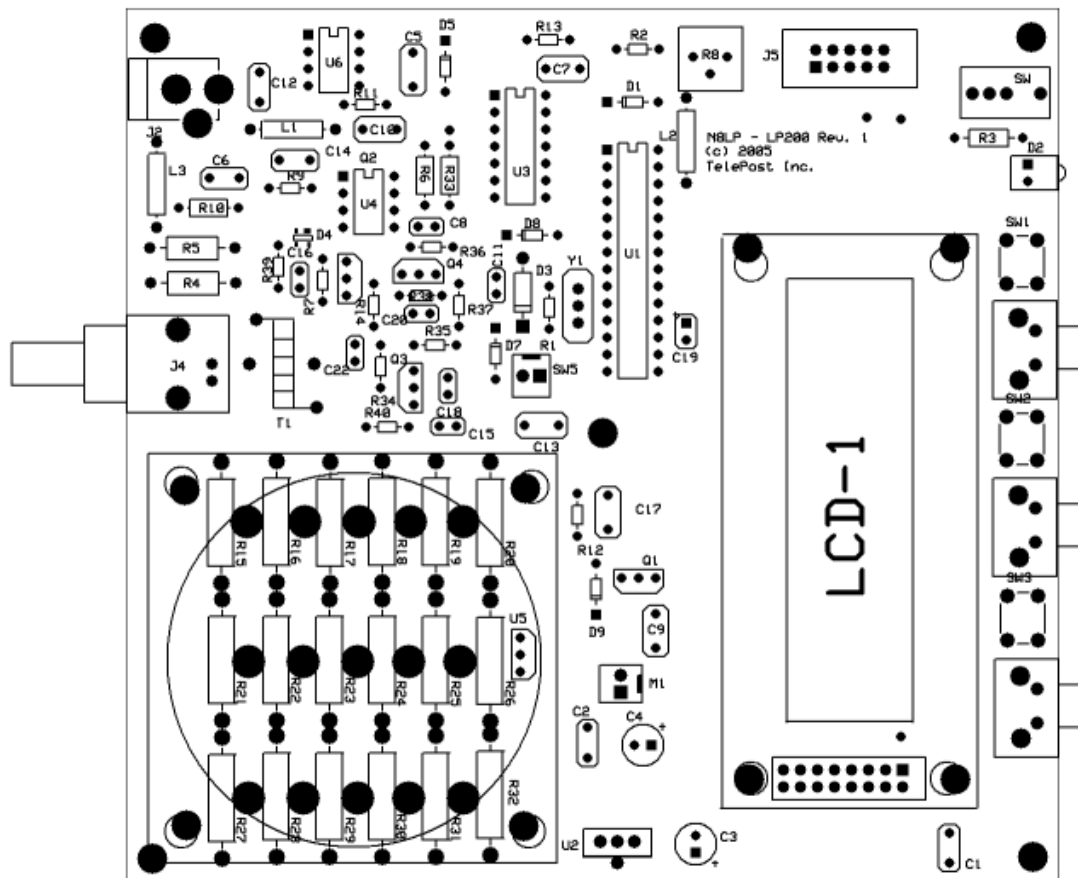

Before starting assembly of the LP-200, you should check the parts bags against the parts list above. Be careful when opening the bags to make sure that no parts are lost. It is a good idea to open the parts bags over a shallow cardboard box lid, like that of a shoebox or shirt box. This will ensure that you won't be looking around on a cluttered counter or the floor for missing parts. It is a good idea to read through these assembly instructions before starting. Be especially careful of D4, the HSMS-2805 dual Schottky diode chip, which is a small SMD part. It is packaged in a little plastic blister pack and taped to a piece of paper.

A 15W soldering iron with a small tip will be best for most of the assembly, along with thin diameter solder. You will also need a small needlenose pliers, diagonal cutters, small Phillips and slotted screwdrivers and a small wrench. To install the HSMS-2805 will also require eye magnification. This can be in the form of magnifying eyewear or a magnifying worklight. If you don't have these, an inexpensive pair of reading glasses from the local pharmacy would make an adequate substitute. Look for a pair with a diopter rating of +2 or +3. A small roll of solder-wick might also come in handy when installing the HSMS-2805.

The only difficult part to install will be the HSMS-2805, but if you plan ahead and work slowly and carefully, you should not have a problem with this part. There are a number of tutorials on the web to help with SMD part installation. Since this part has relatively wide pin spacing for a SMD part, I find the following process to be effective.

Here's a method I use that works well. Carefully place the SMD part over the pads, making sure that it is lined up properly. (One pin is wider and closer spaced than the other three). Match the device to the silkscreen layout.

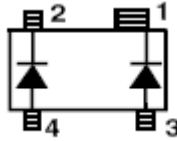

It will take a little practice to get the part placed correctly, while holding it in place. The best tool for this is a good pair of non-magnetized tweezers. You can also use a small, non-magnetized screwdriver for this, or a sharp object like a safety pin bent to allow easy manipulation. There is a design floating around the web for a hands-free holder which uses a safety pin, gum eraser and small weight. This allows you to hold the solder and iron with your free hands. I find that once you have the part properly placed, you can hold it in place with one hand, and tack one pin down to the tinned pad below it. Once the one pin has been tacked in place, you can solder the other three, allowing a very small amount of solder to flow between the pin and pad. Once these three pins are solidly soldered, you can go back and touch up the first pin.

Clean the tip after soldering each pin, and work slowly. If you get too much solder on a pin, or bridge two pins, you can use small SolderWick to clean it up. Let the part cool after extended application of the soldering iron. These parts are much more robust than you might think, but why risk damage?

I would install the HSMS-2805 first, to allow unrestricted access to the pads. Next, I would install the sockets. It's easier to get them installed flat against the board before any other parts are installed. Next I would install the tactile switches for the same reason. The rest of the parts can be installed in any order you like, but I would save the 7805T regulator, LCD, T1 toroidal xfmr and fan for last. The 7805T is tall, and could easily get bent during installation of other parts otherwise, as is also the case with T1. The LCD could get scratched if installed early, even though it has a protective covering. The fan needs to be mounted before it is soldered to the PCB. This is done after initial setup.

Limit new parts to a handful at a time to make it easier to trim the pigtails. There is a mistake in the silkscreening for C4, which shows it as an electrolytic, when obviously it isn't. There is also a silkscreening mistake on the position of Q2... it's actually below and slightly left of U4. Also, C21 is mounted under the PCB. **NOTE: Newer boards have corrected some of these problems, and eliminated the components under the board.** Without the added bypass cap, the temp display flickers a little at high power. You will have to scrape a little of the solder mask away under the board to make room for C21. Its leads should be as short as possible, with one lead going to U3 pin 1 and the other to ground.

You can use the silk-screened part values for the location of most parts. If you are unsure about a part's location or have difficulty reading the silk-screen, refer to the artwork above. Some of the resistors in the area of the preamp/limiter will need to be mounted vertically to fit. When installing the dummy load resistors, you need to place a flat object under each resistor to provide the correct spacing from the board. A scrap of 1/16" PCB material will work well, or a popsicle stick. After the resistors are installed, it is necessary to install U5, the temperature sensor. U5 should be bent so that it touches R26. If you have it, a dab of heat sink compound will ensure a good heat transfer to the sensor, but is not necessary if care is taken to make sure U5 touches R26.

The three jumpers are used at J5 and SW5. J5 is the programming port, and the LCD data is looped through this header. Jumpers need to be installed between pins 3&4 and 5&6, otherwise the LCD will not work. For reference, pins 1&2 are on the end closest to the contrast pot. The third jumper is used at SW5 to enable the LCD backlight. When in place, the backlight is on. If you don't want to use the backlight, just install the jumper on only one pin so that it doesn't get lost. The backlight draws about 200ma, so it makes a big difference in power draw, especially with the 30W (non-fan) version of the load.

Once all the components are installed, you can mount the hardware. This includes four 4-40 x 1/2" standoffs for the fan (round), four 4-40 x 1/2" standoffs for the underside of the board (hex) and two 2-56 x 1/2" standoffs for the LCD display. The standoffs for the LCD should use lockwashers between the board and the standoff to raise the LCD to the correct level to match the height of the connector.

They are installed on between the PCB and spacers on the end of the LCD furthest away from the socket. Lockwashers should also be used for the screws under the fan to avoid being loosened by vibration.

Next, wind the toroid with 11 turns of the enameled wire supplied with the kit. The toroid should be wound over about 90% of the core, with the ends coming off on the correct sides to easily connect to the holes in the silk-screening. A turn is defined as the wire passing through the core. If you count only the turns on the outside of the core, it will look like 10 turns. Leave about 3/4" of lead at the ends. Scrape about 1/2" of insulation off the ends of the wires, pull the ends through the holes until the core is tight to the board, and then solder the leads in place. Trim the small piece of hookup wire to about 3/4", and strip about 1/8" of insulation off the ends. Form the wire into a "U" shape, and feed through the toroid. Insert the ends into the holes in the stripline traces on either side of the core, and then solder in place. Make sure the wire is tight and holds the core against the board.

You'll notice that we haven't installed the fan yet. This is because calibration will be easier without the fan installed, because of better access to the load connections to allow easy measuring of the DC resistance of the load... and also because it will be easier to reach 125 degrees F to measure the "hot" load resistance.

Before applying power to the board, you should mount it to the bottom plate to prevent accidental shorts to stray wire or parts on the bench. Initial checkout should be done without any ICs or the LCD installed. Apply +12-14V to the power jack (the wire with the white stripe on it is the positive lead). Turn the power switch on (up). The LED should light, and you should measure +5V at the output of the 7805T regulator. If all is well, disconnect the power and install the PIC chip and LCD. Be careful to install the PIC with the right orientation, and to line up the pins of the LCD plug with the socket. Set R8 to midrange, and reconnect power. You should see the "splash" screen for a couple seconds, as shown below, followed by the main screen.

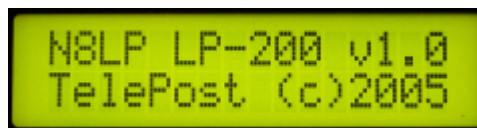

If you do not see it, try adjusting R8 until you see the screen, and then adjust for a pleasing contrast ratio. If you don't see the splash screen, refer to the [Troubleshooting](#) section. If all is well, then turn power off again and install the other ICs, being careful to check orientation as you do.

Power up again. You should see the main power screen, below, although the power reading should be zero, the temp should read near 072 (degrees F) and the load will show 50.0. The center and right buttons below the LCD are used to input values using an Dn/Up scheme. On the main screen, they allow you to switch between degrees F and C. **NOTE: The main screen was changed so that now Freq is displayed instead of Load.**



If all is well to this point, apply a little power from your transmitter. You should see a power reading of roughly the correct value. If this is the case, then you are ready to continue to the [Setup](#) section.

1.2 Setup

The main purpose of the setup procedure is to calibrate your load at normal and hot temperatures, to correct for any op-amp offset error and to set the overall gain, if necessary, and the relative gain between the low and high power inputs.

Pressing the left-most switch button below the LCD display will cycle you through the CAL modes, in

the following order...

Main
CAL - Load Cold
CAL - Load Hot
CAL - Offset
CAL - Gain
CAL - Hi/Lo gain matching

The mode cycles back to the beginning after the last CAL screen.

Before adjusting the CAL screens, you need to make a couple of measurements. First, measure the DC resistance of the dummy load (Load-Cold) by placing probes from a DVM on the ground and top sides of the resistor bank at room temperature (about 70 F, 21 C). It should measure close to 50.0 ohms. Check the resistance of your probes by touching them together. If there is any residual resistance from the probes, this must be subtracted from the measured value of the load. With the probes not connected, apply 10-20W of power to the dummy load. Watch the temp display, and when it reaches 130 F (54 C), turn off the transmitter and disconnect it from the LP-200. Measure the "hot" load resistance (Load-Hot) of the resistor bank as the temperature drops to 125 F (52 C).

Using the mode button, step to the "Load-Cold" screen, and use the Dn or Up buttons to set the cold resistance value to match the reading you measured. Step forward to the "Load-Hot" screen and enter the hot value you measured at 125 F (52 C).

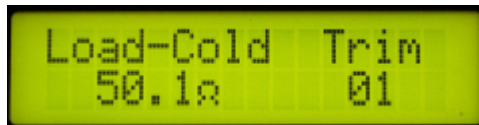

Load-Cold Trim
50.1Ω 01



Load-Hot Trim
50.2Ω 02

Next, step to the "V-Offset" screen. If the Volts display is reading higher than 0.000, use the Dn button to adjust it to zero. This adjustment corrects for any positive offset error in the op-amp input. If the reading is 0.000 to start with, you may still have a negative offset error. To check this, apply minimum power from your xmtr. You should see a reading of .500 volts or lower. Using a DVM monitoring pin 2 of U3, adjust the voltage on the V-Offset screen to match the DVM reading using the Up/Dn buttons. It should require an adjustment of <10 mv.



V-Offset Volts
-0.003 0.000

The next CAL screen is an overall gain setting. This can be used to match your LP-200 an external meter if you have a professional model available for comparison. The gain steps are ~.25% each. Once again, the Up/Dn buttons are used to increment or decrement the steps.



V-Gain Power
1.000 7.408w

The last CAL screen sets the gain on the high power scale to match that of the low power scale. This adjusts out any errors in the resistive divider feeding the A/D input for the high power scale. Apply a signal of 10-20 W, and use the Up/Dn buttons to adjust the reading of the V-high A/D input to match the V-low/2 number, which takes the more sensitive low-power A/D input value and divides it by two in software. There may be a 2-3 bit difference between the two because of the normal A/D error and decreased resolution of the higher power input.



This is the end of the normal setup procedure. The adjustments will be saved in non-volatile memory. You can now mount the fan to the standoffs using the 4-40 x 3/4" screws. The fan is installed with the metallic hub facing upwards (as opposed to the printed label), and with the fan guard on top as shown in the picture. The red wire goes in the left hole, and the black wire goes into the right hole, when looking from the front of the PCB. You should be able to solder these from the top of the PCB, but if you wish you can remove the bottom plate and solder from underneath.

1.3 Circuit Description

You should refer to the schematic for circuit details.

The LP-200 is a combination dummy load and wattmeter. The dummy load is made up of eighteen 100 ohm, 3W, 5% resistors, for an inherent dissipation rating of 54W. A variable-speed fan is provided to extend the power rating 100W continuous. The input BNC connector connects directly to this load, through a current sampling transformer. On average, the eighteen resistors should have a combined error of about 2% maximum. This results in an SWR of about 1.02:1 at low frequencies. Stray coupling and lead inductance causes the SWR to rise with frequency, but it is still under 1.1:1 at 54 mhz.

The current sampling transformer uses 11 turns, and is terminated with a pair of 110 ohm 1% resistors in parallel. Also connected to this point is a 1k resistor which provides a feed to the frequency counter circuit. The parallel combination of the two resistors and the input resistance of the counter preamp results in a load of about 50 ohms. Variations in the combined Z of the two resistors and preamp are calibrated out with a frequency-dependent software correction routine. The sampled current is applied across this 50 ohm load to provide a voltage that is proportional to the input voltage. At the maximum rated input power of 120W, this voltage is approximately $110 V_{peak} / 11 = 10 V_{peak}$.

The signal at this point feeds a diode detector, which in turn feeds an op-amp correction circuit. The op-amp circuit was originally designed by KI6WX, John Grebenkemper, and was used in his Tandem Match article from recent ARRL Antenna Books. He originally described this circuit in an article in the August 1990 QEX issue.

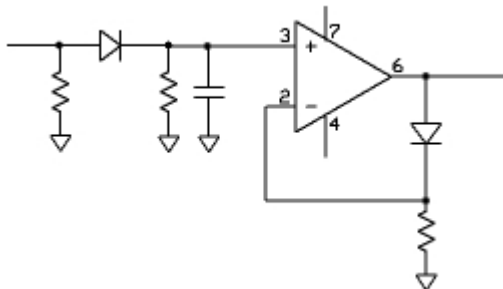

This circuit provides reasonably accurate correction for the diode forward voltage drop if the diodes are carefully chosen. In a departure from the original articles, and in an effort to eliminate the need to match diodes, I am using Agilent dual Schottky diodes on a common substrate in a single package. The dual diodes eliminate the need for diode matching, and have the added advantage of matched temperature coefficient. There are some small remaining errors, caused by the fact that the correction diode is dc biased, while the detector diode is ac biased. The uncorrected errors are within about 7% down to 1 milliwatt. These errors are easily corrected in software.

The output of the detector is fed to two A/D inputs with 12-bit resolution. By feeding one A/D input with a direct feed and the other through a 2:1 voltage divider, I have two simultaneous samples to choose from with a 4:1 difference in power, which I can choose between for an auto-ranging display. This gives me higher sensitivity at low power levels, while still providing high power capability.

Another A/D input is fed from a temperature sensor to allow for temperature correction. The 12-bit A/D converter connects to the PIC microcontroller through the SPI serial interface.

The frequency is sampled at very low power through a 1k resistor bridging the 52.5 ohm load across the current sampling transformer. A three-stage pre-amplifier/limiter provides about 40 dB gain, allowing the frequency counter to work down to <1 mW input. It is important that the correct frequency be known at all times, for the proper correction factor to be applied. The accuracy of the counter is about 5%, due to the use of a ceramic resonator for the PIC clock. This is more than adequate for the correction routine, but may provide a frequency display that appears to be 1 MHz in error near the band edges. This is normal.

The rest of the work is done in software, where the necessary calculations are made and the display is formatted. All correction factors are stored in non-volatile memory to ensure that the meter always boots up with the correct CAL constants. You may want to tape a little piece of paper under the bottom plate with the correction values and Load resistances in case you ever have to replace the PIC.

A 10-pin programming port is provided to allow for software updates in the future, and is normally jumpered out of the circuit.

1.4 Schematic

Schematic

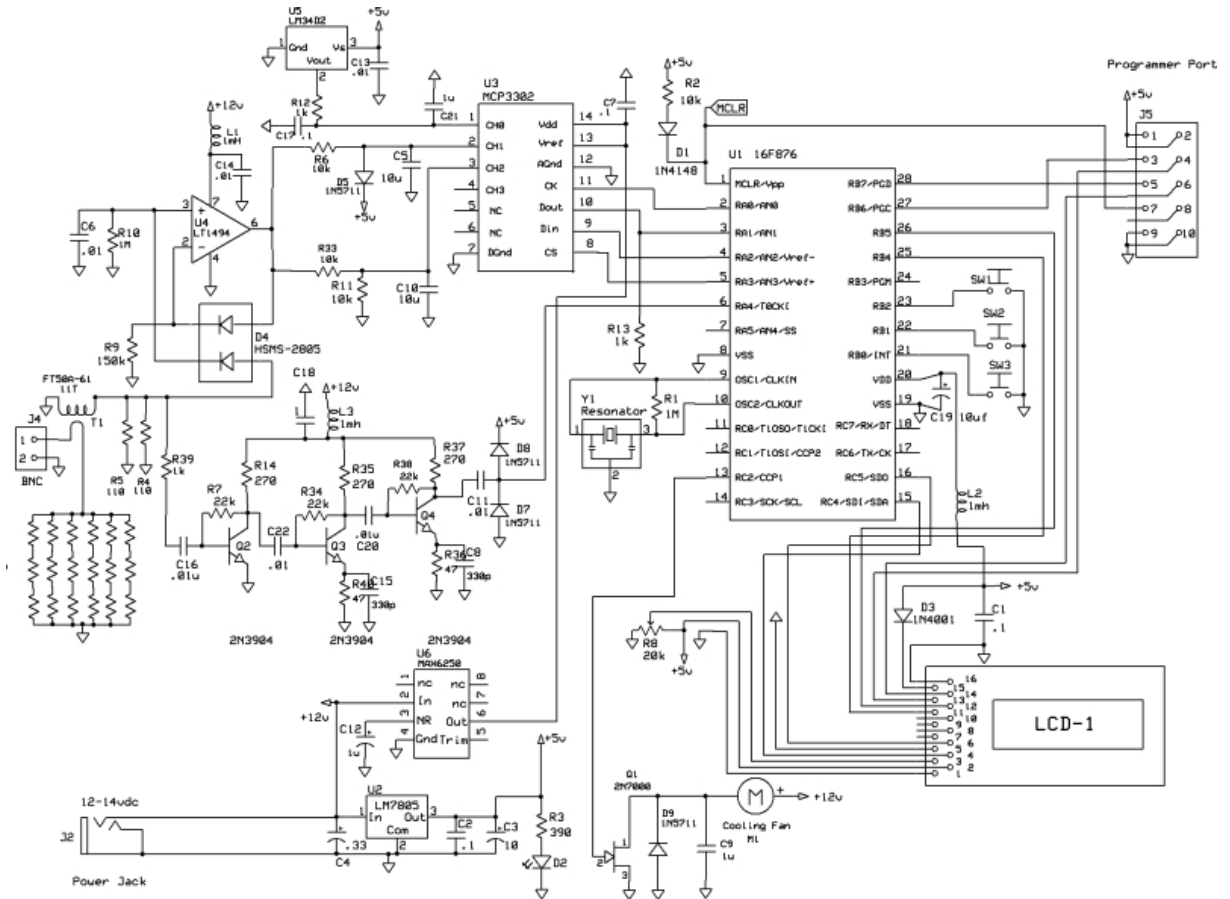

1.5 Troubleshooting

This section is a work in progress. In case of difficulty, contact me at larry@telepostinc.com, or via phone at 734-455-3716.

1.6 Specifications

Features & Specifications

SWR - <1.1:1 from 2-30 mhz, <1.3:1 to 100 mHz... see graphs below
Continuous Power Rating - 30W (100W with variable speed fan option).
Display Resolution - .001W to .1W, depending on scale.
Frequency counter accuracy - 5%
Dual range with auto-ranging.
Displays power, temperature (degrees C or F) and frequency on main screen.
Temperature compensated over load operating range of 65-125F (18-52C)... see graph below
16x2 LCD with selectable backlight.
Precision A/D voltage reference (+/- .02%)
12-bit A/D converter
Five separate calibration screens
Power Input - 10-14 VDC

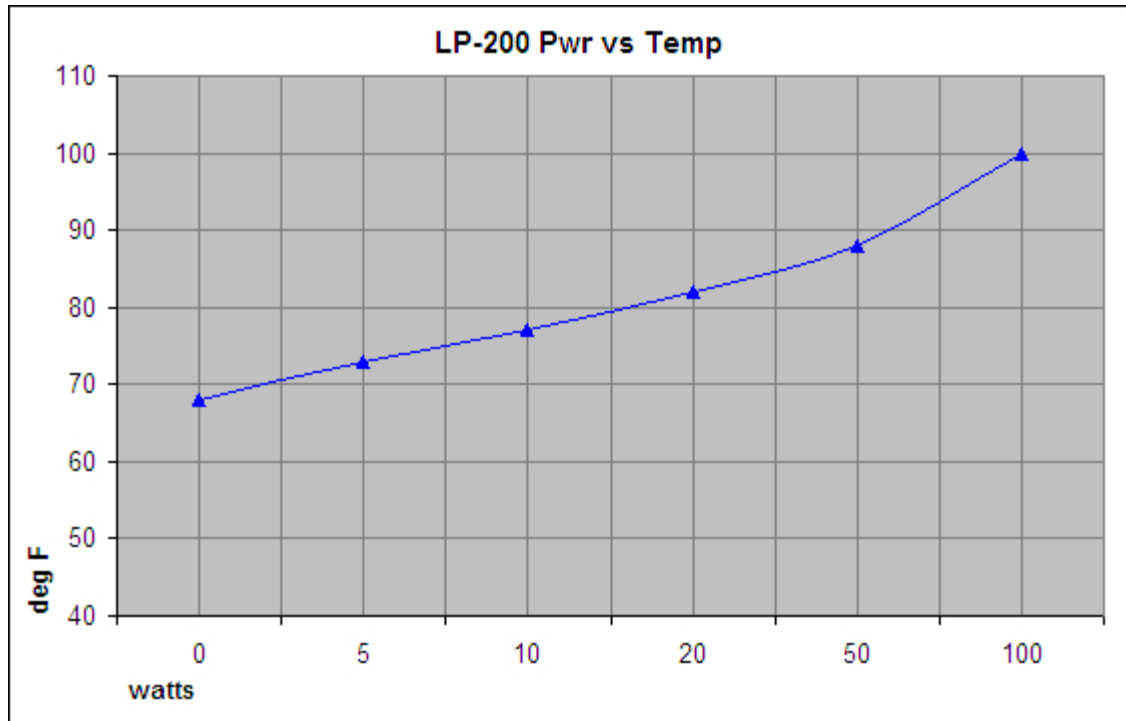

Power vs. Temperature

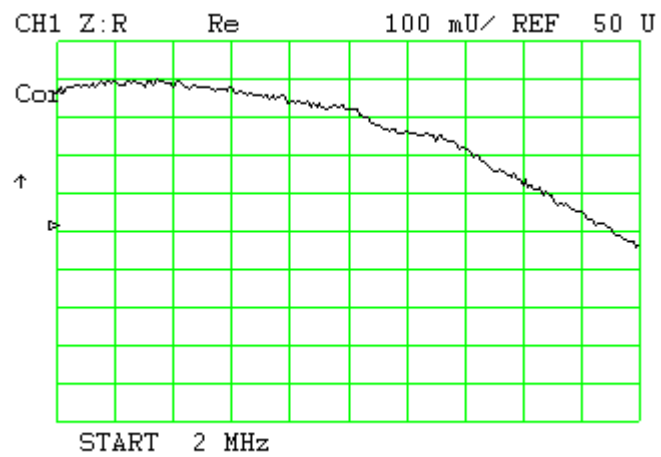
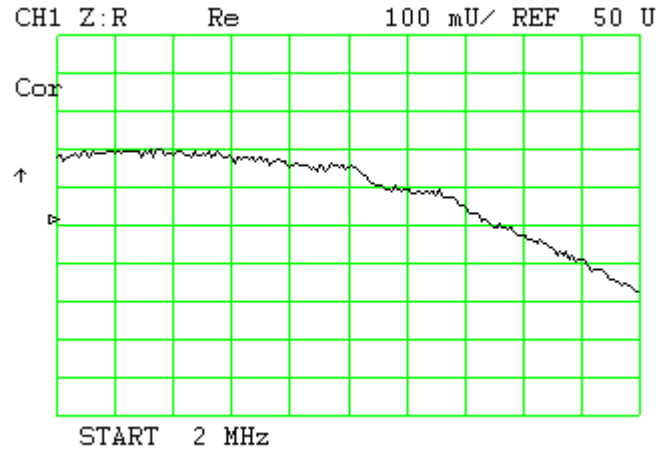

Load resistance at 70 deg F

Load Resistance at 125 deg F

Frequency scale is 2-54 MHz. Vertical scale is .1 ohms/div centered on 50 ohms.