

User Manual

1.5KVA-3KVA INVERTER / CHARGER

Table Of Contents

ABOUT THIS MANUAL	1
Purpose.....	1
Scope.....	1
SAFETY INSTRUCTIONS	1
INTRODUCTION	2
Features.....	2
Basic System Architecture	2
Product Overview.....	3
Unpacking and Inspection.....	4
Preparation	4
Mounting the Unit.....	4
Battery Connection	5
AC Input/Output Connection.....	6
PV Connection	8
Final Assembly.....	9
Communication Connection.....	9
Dry Contact Signal.....	10
OPERATION	11
Power ON/OFF	11
Operation and Display Panel	11
LCD Display Icons	12
LCD Setting.....	14
Display Setting	21
Operating Mode Description	23
Fault Reference Code.....	24
Warning Indicator	24
SPECIFICATIONS	25
Table 1 Line Mode Specifications	25
Table 2 Inverter Mode Specifications	26
Table 3 Charge Mode Specifications	27
Table 4 General Specifications	27
TROUBLE SHOOTING	28

ABOUT THIS MANUAL

Purpose

This manual describes the assembly, installation, operation and troubleshooting of this unit. Please read this manual carefully before installations and operations. Keep this manual for future reference.

Scope

This manual provides safety and installation guidelines as well as information on tools and wiring.

SAFETY INSTRUCTIONS



WARNING: This chapter contains important safety and operating instructions. Read and keep this manual for future reference.

1. Before using the unit, read all instructions and cautionary markings on the unit, the batteries and all appropriate sections of this manual.
2. **CAUTION** --To reduce risk of injury, charge only deep-cycle lead acid type rechargeable batteries. Other types of batteries may burst, causing personal injury and damage.
3. Do not disassemble the unit. Take it to a qualified service center when service or repair is required. Incorrect re-assembly may result in a risk of electric shock or fire.
4. To reduce risk of electric shock, disconnect all wirings before attempting any maintenance or cleaning. Turning off the unit will not reduce this risk.
5. **CAUTION** – Only qualified personnel can install this device with battery.
6. **NEVER** charge a frozen battery.
7. For optimum operation of this inverter/charger, please follow required spec to select appropriate cable size. It's very important to correctly operate this inverter/charger.
8. Be very cautious when working with metal tools on or around batteries. A potential risk exists to drop a tool to spark or short circuit batteries or other electrical parts and could cause an explosion.
9. Please strictly follow installation procedure when you want to disconnect AC or DC terminals. Please refer to INSTALLATION section of this manual for the details.
10. Fuses (3pcs 63A, 65VDC for 12VDC and 24VDC units) are provided as over-current protection for the battery supply.
11. GROUNDING INSTRUCTIONS -This inverter/charger should be connected to a permanent grounded wiring system. Be sure to comply with local requirements and regulation to install this inverter.
12. NEVER cause AC output and DC input short circuited. Do NOT connect to the mains when DC input short circuits.
13. **Warning!!** Only qualified service persons are able to service this device. If errors still persist after following troubleshooting table, please send this inverter/charger back to local dealer or service center for maintenance.

INTRODUCTION

This is a multi-function inverter/charger, combining functions of inverter, solar charger and battery charger to offer uninterruptible power support with portable size. Its comprehensive LCD display offers user-configurable and easy-accessible button operation such as battery charging current, AC/solar charger priority, and acceptable input voltage based on different applications.

There are two different types of built-in solar chargers: PWM or MPPT solar charger. For the detailed product specification, please consult your local dealers.

Features

- Pure sine wave inverter
- Configurable input voltage range for home appliances and personal computers via LCD setting
- Configurable battery charging current based on applications via LCD setting
- Configurable AC/Solar Charger priority via LCD setting
- Compatible to mains voltage or generator power
- Auto restart while AC is recovering
- Overload/ Over temperature/ short circuit protection
- Smart battery charger design for optimized battery performance
- Cold start function

Basic System Architecture

The following illustration shows basic application for this inverter/charger. It also includes following devices to have a complete running system:

- Generator or Utility.
- PV modules (option)

Consult with your system integrator for other possible system architectures depending on your requirements.

This inverter can power all kinds of appliances in home or office environment, including motor-type appliances such as tube light, fan, refrigerator and air conditioner.

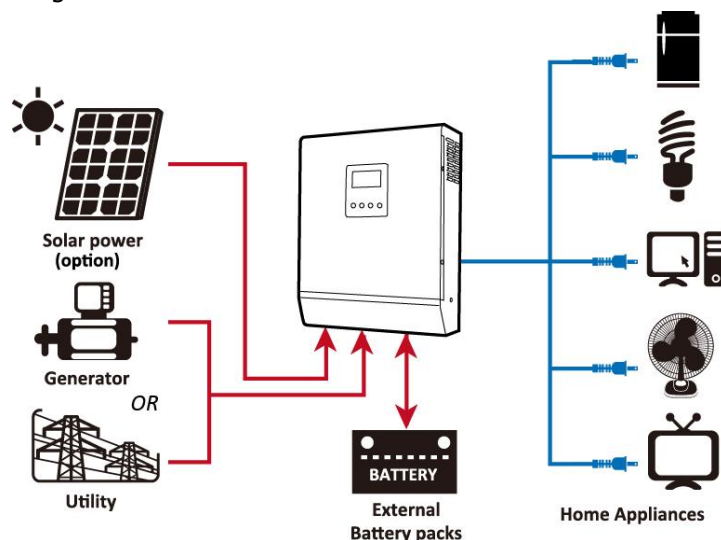
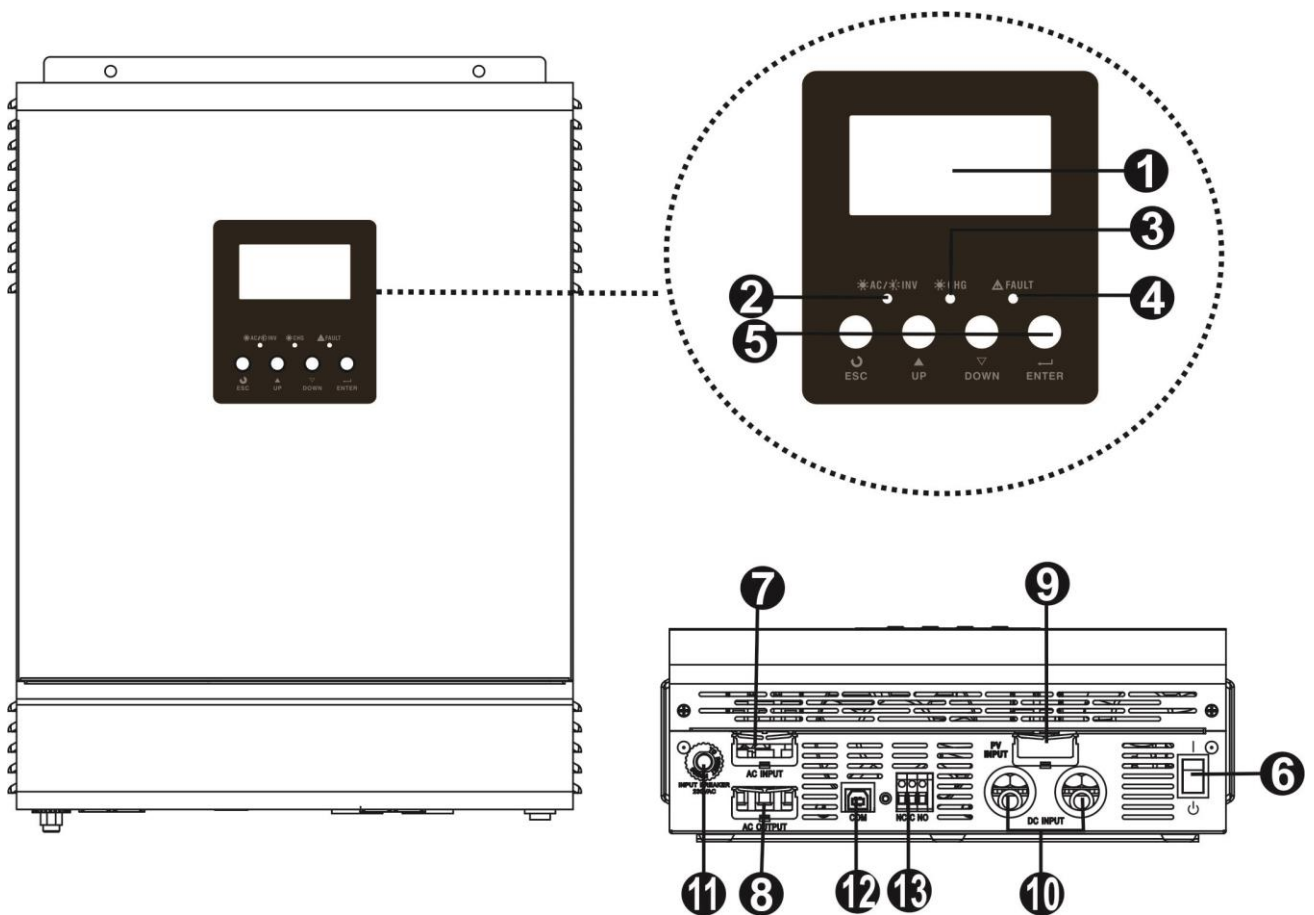

Figure 1 Hybrid Power System

Product Overview



1. LCD display
2. Status indicator
3. Charging indicator
4. Fault indicator
5. Function buttons
6. Power on/off switch
7. AC input
8. AC output
9. PV input
10. Battery input
11. Circuit breaker
12. USB communication port
13. Dry contact

INSTALLATION

Unpacking and Inspection

Before installation, please inspect the unit. Be sure that nothing inside the package is damaged. You should have received the following items inside of package:

- The unit x 1
- User manual x 1
- USB Communication cable x 1
- Software CD x 1

Preparation

Before connecting all wirings, please take off bottom cover by removing two screws as shown below.

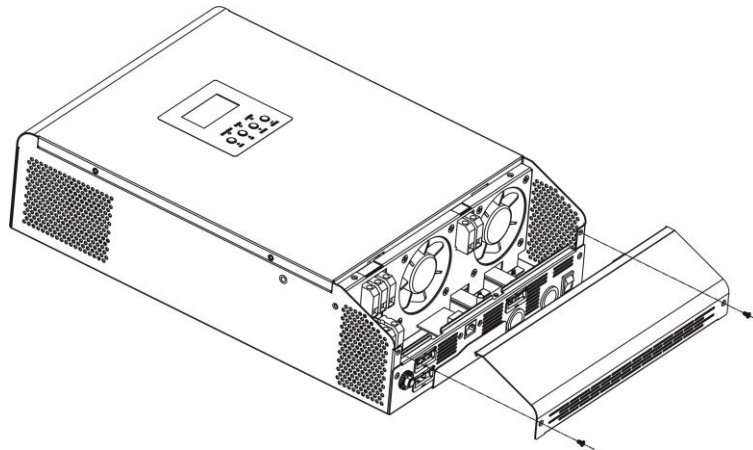

Mounting the Unit

Consider the following points before selecting where to install:

- Do not mount the inverter on flammable construction materials.
- Mount on a solid surface
- Install this inverter at eye level in order to allow the LCD display to be read at all times.
- For proper air circulation to dissipate heat, allow a clearance of approx. 20 cm to the side and approx. 50 cm above and below the unit.
- The ambient temperature should be between -20°C and 55°C to ensure optimal operation.
- The recommended installation position is to be adhered to the wall vertically.
- Be sure to keep other objects and surfaces as shown in the diagram to guarantee sufficient heat dissipation and to have enough space for removing wires.

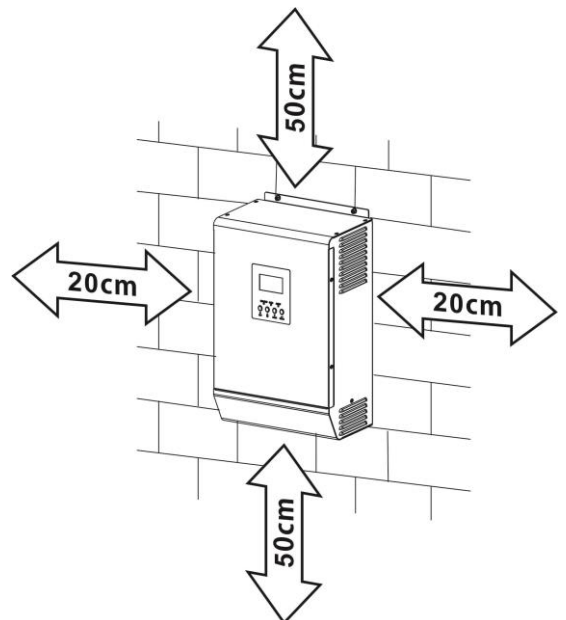

SUITABLE FOR MOUNTING ON CONCRETE OR OTHER NON-COMBUSTIBLE SURFACE ONLY.

Install the unit by screwing three screws.

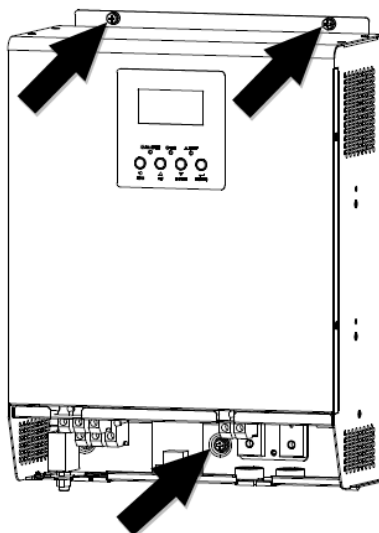

Battery Connection

CAUTION: For safety operation and regulation compliance, it's requested to install a separate DC over-current protector or disconnect device between battery and inverter. It may not be requested to have a disconnect device in some applications, however, it's still requested to have over-current protection installed. Please refer to typical amperage in below table as required fuse or breaker size.

WARNING! All wiring must be performed by a qualified personnel.

WARNING! It's very important for system safety and efficient operation to use appropriate cable for battery connection. To reduce risk of injury, please use the proper recommended cable and terminal size as below.

Ring terminal:

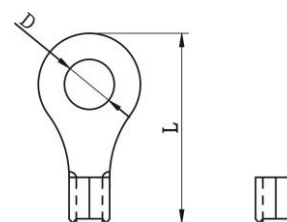

Recommended battery cable and terminal size:

Model	Typical Amperage	Battery capacity	Wire Size	Ring Terminal			Torque value
				Cable mm ²	Dimensions		
					D (mm)	L (mm)	
1.5KVA 24V	50A	100AH	1*8WG	8	6.4	23.8	2~ 3 Nm
1.5KVA 12V 3KVA 24V	100A	100AH	1*4AWG	22	6.4	33.2	2~ 3 Nm
		200AH	2*8AWG	14	6.4	29.2	

Please follow below steps to implement battery connection:

1. Assemble battery ring terminal based on recommended battery cable and terminal size.
2. Connect all battery packs as the unit is required. It's suggested to connect at least 100Ah capacity battery to the unit.

NOTE: Please only use sealed lead acid battery or sealed GEL/AGM lead-acid battery.

3. Insert the ring terminal of battery cable flatly into battery connector of inverter and make sure the bolts are tightened with torque of 2-3 Nm. Make sure polarity at both the battery and the inverter/charge is correctly connected and ring terminals are tightly screwed to the battery terminals.

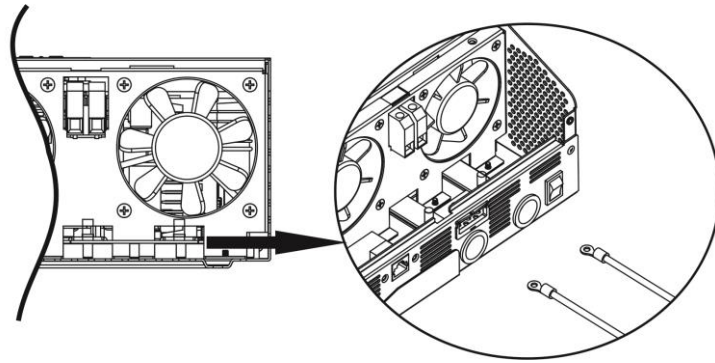

WARNING: Shock Hazard
Installation must be performed with care due to high battery voltage in series.

CAUTION!! Do not place anything between the flat part of the inverter terminal and the ring terminal. Otherwise, overheating may occur.
CAUTION!! Do not apply anti-oxidant substance on the terminals before terminals are connected tightly.
CAUTION!! Before making the final DC connection or closing DC breaker/disconnector, be sure positive (+) must be connected to positive (+) and negative (-) must be connected to negative (-).

AC Input/Output Connection

CAUTION!! Before connecting to AC input power source, please install a **separate** AC breaker between inverter and AC input power source. This will ensure the inverter can be securely disconnected during maintenance and fully protected from over current of AC input. The recommended spec of AC breaker is 20A for 1.5KVA and 30A for 3KVA.

CAUTION!! There are two terminal blocks with "IN" and "OUT" markings. Please do NOT mis-connect input and output connectors.

WARNING! All wiring must be performed by a qualified personnel.

WARNING! It's very important for system safety and efficient operation to use appropriate cable for AC input connection. To reduce risk of injury, please use the proper recommended cable size as below.

Suggested cable requirement for AC wires

Model	Gauge	Torque Value
1.5KVA	16 AWG	0.5~ 0.6 Nm
3KVA	12 AWG	1.2~ 1.6 Nm

Please follow below steps to implement AC input/output connection:

1. Before making AC input/output connection, be sure to open DC protector or disconnector first.
2. Remove insulation sleeve 10mm for six conductors. And shorten phase L and neutral conductor N 3 mm.
3. Insert AC input wires according to polarities indicated on terminal block and tighten the terminal screws. Be sure to connect PE protective conductor (⊕) first.

⊕ → **Ground (yellow-green)**

L → **LINE (brown or black)**

N → **Neutral (blue)**

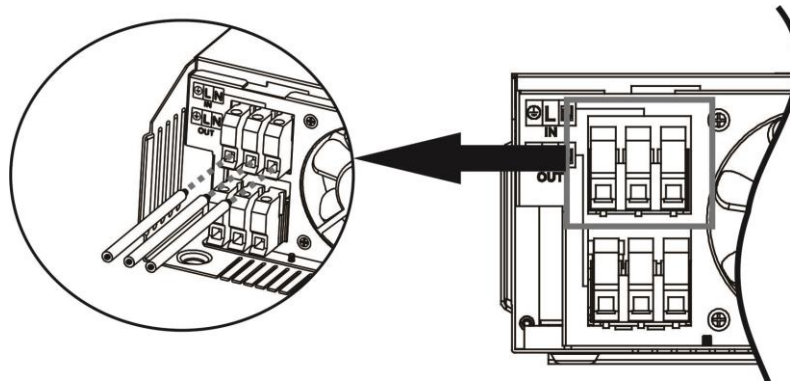

WARNING: Be sure that AC power source is disconnected before attempting to hardwire it to the unit.

- Then, insert AC output wires according to polarities indicated on terminal block and tighten terminal screws. Be sure to connect PE protective conductor (⊕) first.

⊕ → **Ground (yellow-green)**
L → **LINE (brown or black)**
N → **Neutral (blue)**

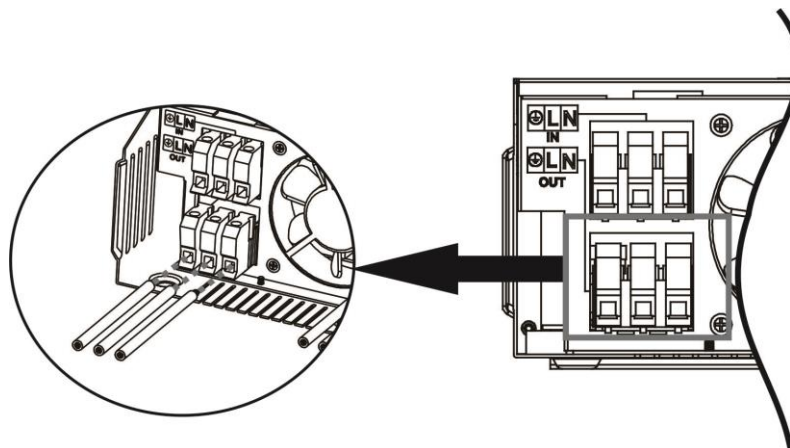

- Make sure the wires are securely connected.

CAUTION: Important
 Be sure to connect AC wires with correct polarity. If L and N wires are connected reversely, it may cause utility short-circuited when these inverters are worked in parallel operation.

CAUTION: Appliances such as air conditioner are required at least 2~3 minutes to restart because it's required to have enough time to balance refrigerant gas inside of circuits. If a power shortage occurs and recovers in a short time, it will cause damage to your connected appliances. To prevent this kind of damage, please check manufacturer of air conditioner if it's equipped with time-delay function before installation. Otherwise, this inverter/charger will trig overload fault and cut off output to protect your appliance but sometimes it still causes internal damage to the air conditioner.

PV Connection

CAUTION: Before connecting to PV modules, please install **separately** a DC circuit breaker between inverter and PV modules.

WARNING! All wiring must be performed by a qualified personnel.

PV Module Selection: (Only for the model with built-in PWM solar charger)

WARNING! It's very important for system safety and efficient operation to use appropriate cable for PV module connection. To reduce risk of injury, please use the proper recommended cable size as below.

Typical Amperage	Gauge	Torque Value
50A	8 AWG	1.4~1.6 Nm

When selecting proper PV modules, please be sure to consider below requirements first:

1. Open circuit Voltage (Voc) of PV modules not exceeds max. PV array open circuit voltage of inverter.

Charging Current (PWM)	50Amp	
System DC Voltage	12Vdc	24Vdc
Operating Voltage Range	15~18Vdc	30~32Vdc
Max. PV Array Open Circuit Voltage	50Vdc	75Vdc

2. Max. Power Voltage (Vmpp) of PV modules should be close to best Vmp of inverter or within Vmp range to get best performance. If one PV module can not meet this requirement, it's necessary to have several PV modules in series connection.

Maximum PV module numbers in Series: V_{mpp} of PV module * X pcs \approx Best Vmp of Inverter or Vmp range

PV module numbers in Parallel: Max. charging current of inverter / I_{mpp}

Total PV module numbers = maximum PV module numbers in series * PV module numbers in parallel

Take 12Vdc unit inverter as an example to select proper PV modules. After considering Voc of PV module not exceeds 50Vdc and max. Vmpp of PV module close to 15Vdc or within 15Vdc ~ 18Vdc, we can choose PV module with below specification.

Maximum Power (Pmax)	85W	Max. PV module numbers in series 1 \rightarrow 17.6 x 1 \approx 15 ~ 18
Max. Power Voltage Vmpp(V)	17.6V	
Max. Power Current Impp(A)	4.83A	PV module numbers in parallel 10 \rightarrow 50 A / 4.83 Total PV module numbers 1 x 10 = 10
Open Circuit Voltage Voc(V)	21.6V	
Short Circuit Current Isc(A)	5.03A	

Maximum PV module numbers in Series: 1

PV module numbers in Parallel: 10

Total PV module numbers: 1 x 10 = 10

Take 24Vdc unit inverter as an example to select proper PV module. After considering Voc of PV module not exceed 75Vdc and max. Vmpp of PV module close to 30Vdc or within 30Vdc ~ 32Vdc, we can choose PV module with below specification.

Maximum Power (Pmax)	260W	Max. PV module numbers in series 1 \rightarrow 30.9 x 1 \approx 30 ~ 32
Max. Power Voltage Vmpp(V)	30.9V	
Max. Power Current Impp(A)	8.42A	PV module numbers in parallel 6 \rightarrow 50 A / 8.42 Total PV module numbers 1 x 6 = 6
Open Circuit Voltage Voc(V)	37.7V	
Short Circuit Current Isc(A)	8.89A	

Maximum PV module numbers in Series: 1

PV module numbers in Parallel: 6

Total PV module numbers: 1 x 6 = 6

PV Module Selection: (Only for the model with built-in MPPT solar charger)

When selecting proper PV modules, please be sure to consider below parameters:

- 3. Open circuit Voltage (Voc) of PV modules not exceeds max. PV array open circuit voltage of inverter.
- 4. Open circuit Voltage (Voc) of PV modules should be higher than min. battery voltage.

INVERTER MODEL	12Vdc	24Vdc
Max. PV Array Open Circuit Voltage	100Vdc	
PV Array MPPT Voltage Range	15~80Vdc	30~80Vdc

Please follow below steps to implement PV module connection:

- 1. Remove insulation sleeve 10 mm for positive and negative conductors.
- 2. Check correct polarity of connection cable from PV modules and PV input connectors. Then, connect positive pole (+) of connection cable to positive pole (+) of PV input connector. Connect negative pole (-) of connection cable to negative pole (-) of PV input connector.

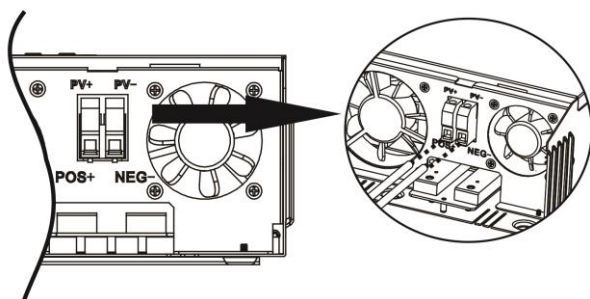
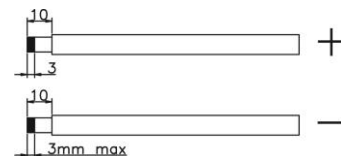

- 3. Make sure the wires are securely connected.

Final Assembly

After connecting all wirings, please put bottom cover back by screwing two screws as shown below.

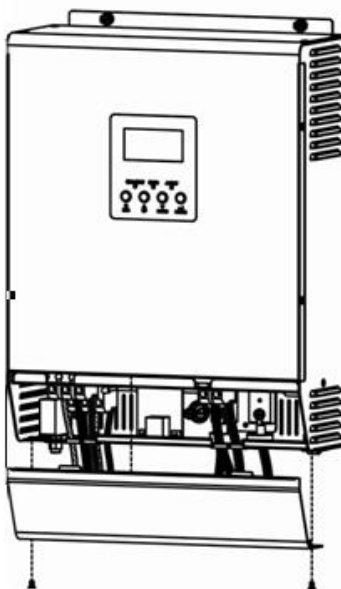

Communication Connection

Please use supplied communication cable to connect to inverter and PC. Insert bundled CD into a computer and follow on-screen instruction to install the monitoring software. For the detailed software operation, please check user manual of software inside of CD.

Dry Contact Signal

There is one dry contact (3A/250VAC) available on the rear panel. It could be used to deliver signal to external device when battery voltage reaches warning level.

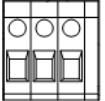
Unit Status	Condition		Dry contact port: 		
			NC & C	NO & C	
Power Off	Unit is off and no output is powered.		Close	Open	
Power On	Output is powered from Utility.		Close	Open	
	Output is powered from Battery or Solar.	Program 01 set as Utility	Battery voltage < Low DC warning voltage	Open	Close
			Battery voltage > Setting value in Program 21 or battery charging reaches floating stage	Close	Open
	Output is powered from Battery or Solar.	Program 01 is set as SBU or Solar first	Battery voltage < Setting value in Program 20	Open	Close
Battery voltage > Setting value in Program 21 or battery charging reaches floating stage			Close	Open	

OPERATION

Power ON/OFF

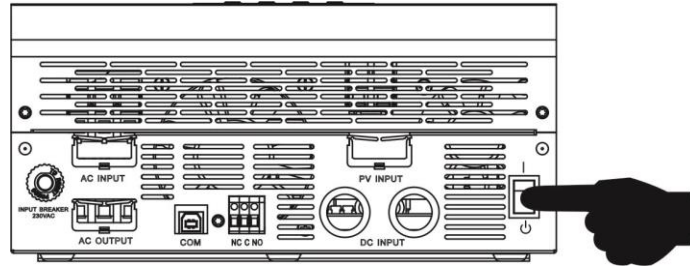

Once the unit has been properly installed and the batteries are connected well, simply press On/Off switch (located on the button of the case) to turn on the unit.

Operation and Display Panel

The operation and display panel, shown in below chart, is on the front panel of the inverter. It includes three indicators, four function keys and a LCD display, indicating the operating status and input/output power information.

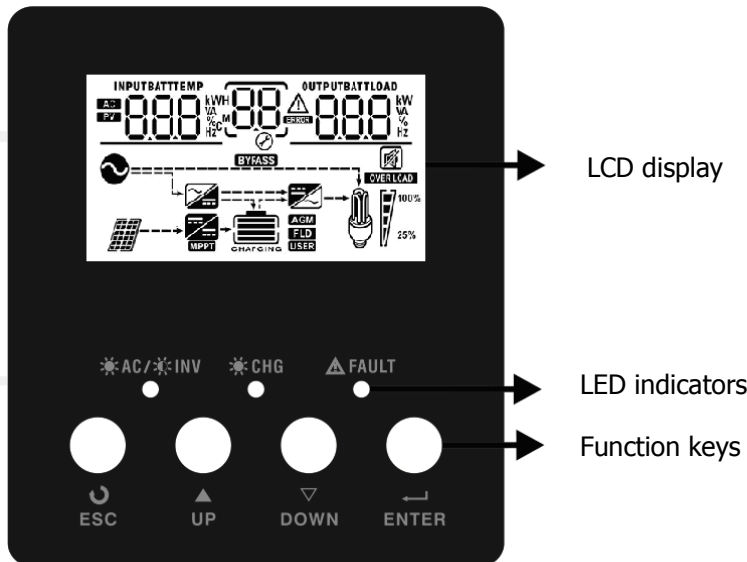

LED Indicator

LED Indicator		Messages	
☀️ AC / 🌙 INV	Green	Solid On	Output is powered by utility in Line mode.
		Flashing	Output is powered by battery or PV in battery mode.
☀️ CHG	Green	Solid On	Battery is fully charged.
		Flashing	Battery is charging.
⚠️ FAULT	Red	Solid On	Fault occurs in the inverter.
		Flashing	Warning condition occurs in the inverter.

Function Keys

Function Key	Description
ESC	To exit setting mode
UP	To go to previous selection
DOWN	To go to next selection
ENTER	To confirm the selection in setting mode or enter setting mode

LCD Display Icons

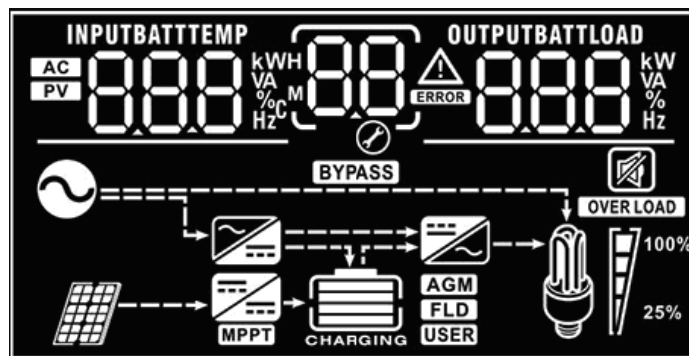

Icon	Function description	
Input Source Information		
AC	Indicates the AC input.	
PV	Indicates the PV input	
INPUTBATT 	Indicate input voltage, input frequency, PV voltage, battery voltage and charger current.	
Configuration Program and Fault Information		
	Indicates the setting programs.	
	Indicates the warning and fault codes. Warning: flashing with warning code. Fault: lighting with fault code	
Output Information		
OUTPUTBATTLOAD 	Indicate output voltage, output frequency, load percent, load in VA, load in Watt and discharging current.	
Battery Information		
	Indicates battery level by 0-24%, 25-49%, 50-74% and 75-100% and charging status.	
AGM FLD USER	Indicates the battery type: AGM, Flooded or User-defined battery.	
It will present battery capacity when unit is charging.		
Status	Battery voltage	LCD Display
Constant Current mode / Constant	<2V/cell	4 bars will flash in turns.
	2 ~ 2.083V/cell	Bottom bar will be on and the other three bars will flash in turns.
	2.083 ~ 2.167V/cell	Bottom two bars will be on and the other two bars will flash in turns.

Voltage mode	> 2.167 V/cell	Bottom three bars will be on and the top bar will flash.		
Floating mode. Batteries are fully charged.		4 bars will be on.		
Battery level icon will present battery capacity when unit is discharged.				
Load Percentage	Battery Voltage	LCD Display		
Load > 20%	< 1.817V/cell			
	1.817V/cell ~ 1.9V/cell			
	1.9 ~ 1.983V/cell			
	> 1.983 V/cell			
Load < 20%	< 1.867V/cell			
	1.867V/cell ~ 1.95V/cell			
	1.95 ~ 2.033V/cell			
	> 2.033/cell			
Load Information				
OVER LOAD	Indicates overload.			
	Indicates the load level by 0-24%, 25-50%, 50-74% and 75-100%.			
	0%~25%	25%~50%	50%~75%	75%~100%
Mode Operation Information				
	Indicates unit connects to the mains.			
	Indicates unit connects to the PV panel.			
BYPASS	Indicates load is supplied by utility power.			
	Indicates the utility charger circuit is working.			
	Indicates the solar charger circuit is working.			
MPPT	Indicates the solar charger is MPPT type.			
	Indicates the DC/AC inverter circuit is working.			
Mute Operation				
	Indicates unit alarm is disabled.			









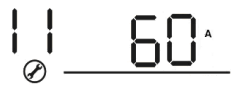
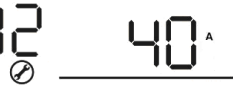
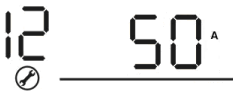
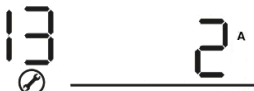
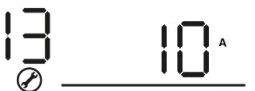

LCD Setting

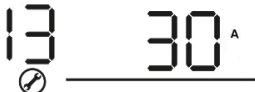
After pressing and holding ENTER button for 3 seconds, the unit will enter setting mode. Press "UP" or "DOWN" button to select setting programs. And then, press "ENTER" button to confirm the selection or ESC button to exit.













































Setting Programs:

Program	Description	Selectable option	
00	Exit setting mode	Escape 00 ESC	
01	Output source priority: To configure load power source priority	Solar first 01 SOL	Solar energy provides power to the loads as first priority. If solar energy is not sufficient to power all connected loads, battery energy will supply power to the loads at the same time. Utility provides power to the loads only when any one condition happens: - Solar energy is not available. - Battery voltage drops to low-level warning voltage or the setting point in program 20.
		Utility first (default) 01 UTI	Utility will provide power to the loads as first priority. Solar and battery energy will provide power to the loads only when utility power is not available.
		SBU priority 01 SBU	Solar energy provides power to the loads as first priority. If solar energy is not sufficient to power all connected loads, battery energy will supply power to the loads at the same time. Utility provides power to the loads only when battery voltage drops to either low-level warning voltage or the setting point in program 20.
02	AC input voltage range	Appliances (default) 02 APL	If selected, acceptable AC input voltage range will be within 90-280VAC.
		UPS 02 UPS	If selected, acceptable AC input voltage range will be within 170-280VAC.

03	Output voltage	220Vac 03 220 ^v	230V (Default) 03 230 ^v
		240Vac 03 240 ^v	
04	Output frequency	50Hz (default) 04 50 ^{Hz}	60Hz 04 60 ^{Hz}
05	Power saving mode enable/disable	Saving mode disable (default) 05 5d5	If disabled, no matter connected load is low or high, the on/off status of inverter output will not be effected.
		Saving mode enable 05 5eN	If enabled, the output of inverter will be off when connected load is pretty low or not detected.
06	Overload bypass: When enabled, the unit will transfer to line mode if overload occurs in battery mode.	Bypass disable (default) 06 byd	Bypass enable 06 byE
07	Auto restart when overload occurs	Restart disable (default) 07 Lfd	Restart enable 07 LfE
08	Auto restart when over temperature occurs	Restart disable (default) 08 tfd	Restart enable 08 tFE
10	Charger source priority: To configure charger source priority	If this inverter/charger is working in Line, Standby or Fault mode, charger source can be programmed as below:	
		Solar first 10 CS0	Solar energy will charge battery as first priority. Utility will charge battery only when solar energy is not available.
		Utility first 10 CUt	Utility will charge battery as first priority. Solar energy will charge battery only when utility power is not available.
		Solar and Utility (default) 10 SNU	Solar energy and utility will charge battery at the same time.
		Only Solar 10 0S0	Solar energy will be the only charger source no matter utility is available or not.

		If this inverter/charger is working in Battery mode or Power saving mode, only solar energy can charge battery. Solar energy will charge battery if it's available and sufficient.	
11	Maximum charging current: To configure total charging current for solar and utility chargers. (Max. charging current = utility charging current + solar charging current)	60A (default) 	For unit with MPPT solar charger, setting range is from 10A to 100A. For unit with PWM solar charger, setting range is from 10A to 110A. Increment of each click is 10A.
12	Maximum solar charging current	40A (default for unit with MPPT solar charger) 	When the unit is built with MPPT solar charger, default setting is 40A. Setting range is from 10A to 40A and increment of each click is 10A.
		50A (default for unit with PWM solar charger) 	When the unit is built with PWM solar charger, default setting is 50A. Setting range is from 10A to 50A and increment of each click is 10A.
13	Maximum utility charging current	2A 	10A 
		20A 	30A (default) 
		40A 	50A 
		60A 	
14	Battery type	AGM (default) 	Flooded 
		User-Defined 	If "User-Defined" is selected, battery charge voltage and low DC cut-off voltage can be set up in program 17, 18 and 19.
15	Charger stage selection	Auto 	2 Step 

		3 Step 15 35t ⊗	
16	CV charging time setting	Auto 16 AUT ⊗	No CV charging time 16 0 ⊗
		10min 16 10 ⊗	20min 16 20 ⊗
		40min 16 40 ⊗	60min 16 60 ⊗
		90min 16 90 ⊗	120min 16 120 ⊗
		150min 16 150 ⊗	180min 16 180 ⊗
		210min 16 210 ⊗	240min 16 240 ⊗
		12V model default setting: 14.1V CV 17 BATT 14.1v ⊗	
		24V model default setting: 28.2V CV 17 BATT 28.2v ⊗	
17	Bulk charging voltage (C.V voltage)	If self-defined is selected in program 14, this program can be set up. Setting range is from 12.0V to 15.3V for 12Vdc model and 24.0V to 30.6V for 24Vdc model. Increment of each click is 0.1V.	
18	Floating charging voltage	12V model default setting: 13.5V FLV 18 BATT 13.5v ⊗	
		24V model default setting: 27.0V FLV 18 BATT 27.0v ⊗	

		<p>If self-defined is selected in program 14, this program can be set up. Setting range is from 12.0V to 15.3V for 12Vdc model and 24.0V to 30.6V for 24Vdc model.</p> <p>Increment of each click is 0.1V.</p>		
19	Low DC cut off battery voltage setting	<p>12V model default setting: 10.2V</p> 		
		<p>24V model default setting: 20.4V</p> 		
		<p>If self-defined is selected in program 14, this program can be set up. Setting range is from 10.2V to 12.0V for 12Vdc model and 20.4V to 24V for 24Vdc model. Increment of each click is 0.1V. Low DC cut-off voltage will be fixed to setting value no matter what percentage of load is connected.</p>		
20	Setting voltage point back to utility source when selecting "SBU priority" or "Solar first" in program 01.	<p>Available options for 12V models:</p>		
		<table border="0"> <tr> <td>11.0V </td> <td>11.3V </td> </tr> </table>	11.0V 	11.3V 
		11.0V 	11.3V 	
		<table border="0"> <tr> <td>11.5V (default) </td> <td>11.8V </td> </tr> </table>	11.5V (default) 	11.8V 
		11.5V (default) 	11.8V 	
		<table border="0"> <tr> <td>12.0V </td> <td>12.3V </td> </tr> </table>	12.0V 	12.3V 
		12.0V 	12.3V 	
		<table border="0"> <tr> <td>12.5V </td> <td>12.8V </td> </tr> </table>	12.5V 	12.8V 
		12.5V 	12.8V 	
		<p>Available options for 24V models:</p>		
<table border="0"> <tr> <td>22.0V </td> <td>22.5V </td> </tr> </table>	22.0V 	22.5V 		
22.0V 	22.5V 			
<table border="0"> <tr> <td>23.0V (default) </td> <td>23.5V </td> </tr> </table>	23.0V (default) 	23.5V 		
23.0V (default) 	23.5V 			
<table border="0"> <tr> <td>24.0V </td> <td>24.5V </td> </tr> </table>	24.0V 	24.5V 		
24.0V 	24.5V 			



		25.0V 20 ^{BATT} 25.0 _v	25.5V 20 ^{BATT} 25.5 _v
21	Setting voltage point back to battery mode when selecting "SBU priority" or "Solar first" in program 01.	Available options for 12V models:	
		Battery fully charged 21 ^{BATT} FUL	12.0V 21 ^{BATT} 12.0 _v
		12.3V 21 ^{BATT} 12.3 _v	12.5V 21 ^{BATT} 12.5 _v
		12.8V 21 ^{BATT} 12.8 _v	13.0V 21 ^{BATT} 13.0 _v
		13.3V 21 ^{BATT} 13.3 _v	13.5V (default) 21 ^{BATT} 13.5 _v
		13.8V 21 ^{BATT} 13.8 _v	14.0V 21 ^{BATT} 14.0 _v
		14.3V 21 ^{BATT} 14.3 _v	14.5V 21 ^{BATT} 14.5 _v
		Available options for 24V models:	
		Battery fully charged 21 ^{BATT} FUL	24V 21 ^{BATT} 24.0 _v
		24.5V 21 ^{BATT} 24.5 _v	25V 21 ^{BATT} 25.0 _v
		25.5V 21 ^{BATT} 25.5 _v	26V 21 ^{BATT} 26.0 _v
		26.5V 21 ^{BATT} 26.5 _v	27V (default) 21 ^{BATT} 27.0 _v

		27.5V 21 ^{BATT} 27.5 v	28V 21 ^{BATT} 28.0 v
		28.5V 21 ^{BATT} 28.5 v	29V 21 ^{BATT} 29.0 v
22	Auto return to default display screen	Return to default display screen (default) 22 ^{ESP}	If selected, no matter how users switch display screen, it will automatically return to default display screen (Input voltage /output voltage) after no button is pressed for 1 minute.
		Stay at latest screen 22 ^{LEP}	If selected, the display screen will stay at latest screen user finally switches.
23	Backlight control	Backlight on (default) 23 ^{LON}	Backlight off 23 ^{LOF}
24	Alarm control	Alarm on (default) 24 ^{bon}	Alarm off 24 ^{bof}
25	Beeps while primary source is interrupted	Alarm on (default) 25 ^{RON}	Alarm off 25 ^{ROF}
27	Record Fault code	Record enable(default) 27 ^{FEN}	Record disable 27 ^{FDS}

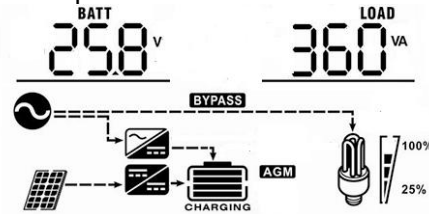
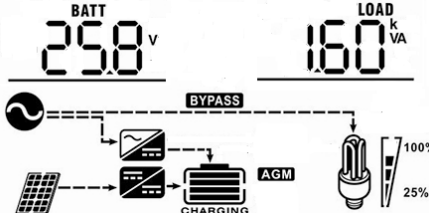
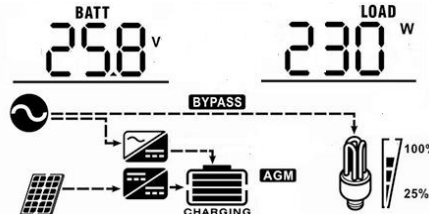
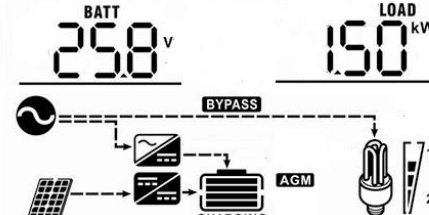

Display Setting

The LCD display information will be switched in turns by pressing "UP" or "DOWN" key. The selectable information is switched as below order: input voltage/output voltage, input frequency, PV voltage, charging current, output frequency, load percentage, load in VA, load in Watt, battery voltage/DC discharging current, main CPU Version and secondary CPU Version.

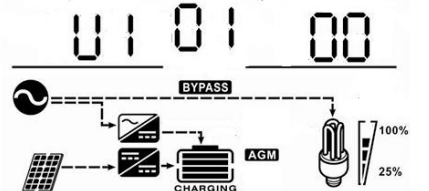
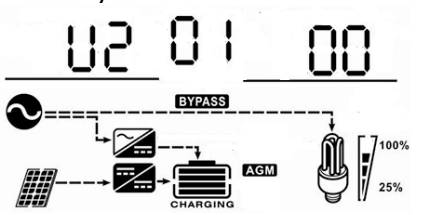
Selectable information	LCD display
Input voltage/Output voltage (Default Display Screen)	<p>Input Voltage=230V, output voltage=230V</p>
Input frequency	<p>Input frequency=50Hz</p>
PV voltage	<p>PV voltage=60V</p>
Charging current	<p>Charging current=80A</p>
Output frequency	<p>Output frequency=50Hz</p>
Load percentage	<p>Load percent=60%</p>

<p>Load in VA</p>	<p>When connected load is lower than 1kVA, load in VA will present xxxVA like below chart.</p>  <p>When load is larger than 1kVA ($\geq 1\text{kVA}$), load in VA will present x.xkVA like below chart.</p> 
<p>Load in Watt</p>	<p>When load is lower than 1kW, load in W will present xxxW like below chart.</p>  <p>When load is larger than 1kW ($\geq 1\text{kW}$), load in W will present x.xkW like below chart.</p> 
<p>Battery voltage/ DC discharging current</p>	<p>Battery voltage=25.8V, discharging current=80A</p> 
<p>Main CPU version checking</p>	<p>Main CPU version 00001.00</p> 
<p>Secondary CPU version checking</p>	<p>Secondary CPU version 00001.00</p> 

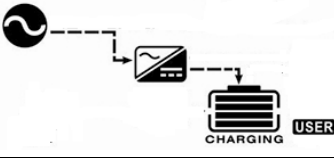
Operating Mode Description

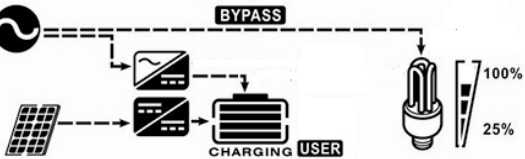
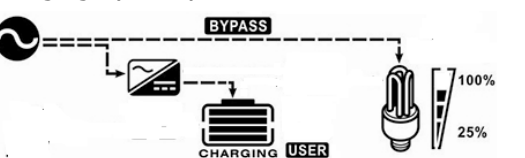
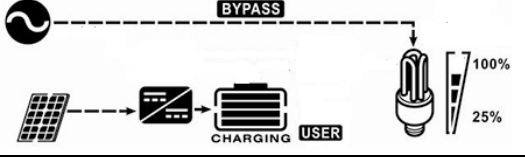
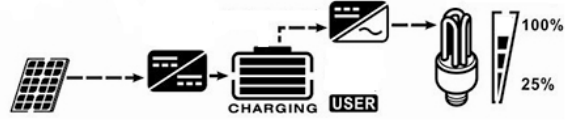
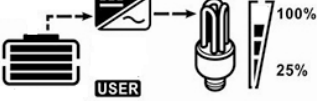
Operation mode	Description	LCD display
<p>Standby mode / Power saving mode/ Fault mode</p> <p>Note:</p> <p>*Standby mode: The inverter is not turned on yet but at this time, the inverter can charge battery without AC output.</p> <p>*Power saving mode: If enabled, the output of inverter will be off when connected load is pretty low or not detected.</p> <p>*Fault mode: Errors are caused by inside circuit error or external reasons such as over temperature, output short circuited and so on.</p>	<p>No output is supplied by the unit but it still can charge batteries.</p>	<p>Charging by utility and PV energy.</p> 
		<p>Charging by utility.</p> 
		<p>Charging by PV energy.</p> 
		<p>No charging.</p> 
<p>Line Mode</p>	<p>The unit will provide output power from the mains. It will also charge the battery at line mode.</p>	<p>Charging by utility and PV energy.</p> 
		<p>Charging by utility.</p> 
		<p>Charging by PV energy.</p> 
<p>Battery Mode</p>	<p>The unit will provide output power from battery and PV energy.</p>	<p>Power from battery and PV energy.</p> 
		<p>Power from battery only.</p> 

Fault Reference Code

Fault Code	Fault Event	Icon on
01	Fan is locked when inverter is off.	
02	Over temperature	
03	Battery voltage is too high	
05	Output short circuited.	
06	Output voltage is too high.	
07	Overload time out	
08	Bus voltage is too high	
09	Bus soft start failed	
51	Over current or surge	
52	Bus voltage is too low	
53	Inverter soft start failed	
55	Over DC voltage in AC output	
56	Battery detection circuit error	
57	Current sensor failed	
58	Output voltage is too low	

Warning Indicator

Warning Code	Warning Event	Audible Alarm	Icon flashing
01	Fan is locked when inverter is on.	Beep three times every second	
03	Battery is over-charged	Beep once every second	
04	Low battery	Beep once every second	
07	Overload	Beep once every 0.5 second	
10	Output power derating	Beep twice every 3 seconds	

SPECIFICATIONS

Table 1 Line Mode Specifications

INVERTER MODEL	1.5K-12V / 1.5K-24V / 3K-24V
Input Voltage Waveform	Sinusoidal (utility or generator)
Nominal Input Voltage	220/230/240Vac
Low Loss Voltage	170Vac±7V (UPS); 90Vac±7V (Appliances)
Low Loss Return Voltage	180Vac±7V (UPS); 100Vac±7V (Appliances)
High Loss Voltage	280Vac±7V
High Loss Return Voltage	270Vac±7V
Max AC Input Voltage	300Vac
Nominal Input Frequency	50Hz / 60Hz (Auto detection)
Low Loss Frequency	40±1Hz
Low Loss Return Frequency	42±1Hz
High Loss Frequency	65±1Hz
High Loss Return Frequency	63±1Hz
Output Short Circuit Protection	Circuit Breaker
Efficiency (Line Mode)	>95% (Rated R load, battery full charged)
Transfer Time	10ms typical (UPS); 20ms typical (Appliances)
<p>Output power derating: When AC input voltage drops to 170V, the output power will be de-rated.</p>	<p>The graph illustrates the output power derating characteristics. The vertical axis represents Output Power, with two specific levels marked: 50% Power and Rated Power. The horizontal axis represents Input Voltage, with three key points marked: 90V, 170V, and 280V. The power remains constant at a low level until 90V. At 90V, the power begins to rise linearly, reaching the Rated Power level at 170V. From 170V to 280V, the output power remains constant at the Rated Power level. Beyond 280V, the power drops abruptly to zero.</p>

Table 2 Inverter Mode Specifications

Inverter Mode			
Inverter Model	1.5K-12V	1.5K-24V	3K-24V
Rated Output Power	1500VA/1200W		3000VA/2400W
Output Voltage Waveform	Pure Sine Wave		
Output Voltage Regulation	220Vac/230Vac/240Vac±5%		
Output Frequency	50Hz		
Peak Efficiency	90%		
Overload Protection	5s@≥150% load; 10s@110%~150% load		
Surge Capacity	2 x rated power for 5sec		
Nominal DC Voltage	12Vdc	24Vdc	
Cold Start Voltage	11.5Vdc	23.0Vdc	
Low DC Warning Voltage			
@ load < 20%	11.0Vdc	22.0Vdc	
@ load ≥ 20%	10.7Vdc	21.4Vdc	
Low DC Warning Recovery Voltage			
@ load < 20%	11.5Vdc	23.0Vdc	
@ load ≥ 20%	11.2Vdc	22.4Vdc	
Low DC Cut-off Voltage			
@ load < 20%	10.5Vdc	21.0Vdc	
@ load ≥ 20%	10.2Vdc	20.4Vdc	
High DC Recovery Voltage	15.0Vdc	31.0Vdc	
High DC Cut-off Voltage	16.0Vdc	32.0Vdc	
DC Voltage Accuracy	+/-0.3%V@ no load		
THDV	<3% for linear load,<5% for non-linear load @ nominal voltage		
DC Offset	≤100mV		
No Load Power Consumption	<25W		
Saving Mode Power Consumption	<10W		

Table 3 Charge Mode Specifications

INVERTER MODEL		1.5K-12V	1.5K-24V / 3K-24V
Charging Algorithm		3-Step	
Utility Charging Mode			
AC Charging Current		2/10/20/30/40/50/60Amp (@ $V_{I/P}=230Vac$)	
Bulk Charging Voltage	Flooded Battery	14.6Vdc	29.2Vdc
	AGM / Gel Battery	14.1Vdc	28.2Vdc
Floating Charging Voltage		13.5Vdc	27.0Vdc
Charging Curve			
PWM Solar Charging Mode			
Charging Current		50Amp	
System DC Voltage		12Vdc	24Vdc
Operating Voltage Range		15~18Vdc	30~32Vdc
Max. PV Array Open Circuit Voltage		50Vdc	75Vdc
DC Voltage Accuracy		+/-0.3%	
Joint Utility and Solar Charging			
Max Charging Current		110Amp	
Default Charging Current		60Amp	
MPPT Solar Charging Mode			
Charging Current		40Amp	
PV Array MPPT Voltage Range		15Vdc ~ 80Vdc	30Vdc ~ 80Vdc
Max. PV Array Open Circuit Voltage		100Vdc	
DC Voltage Accuracy		+/-0.3%	
Joint Utility and Solar Charging			
Max Charging Current		100Amp	
Default Charging Current		60Amp	

Table 4 General Specifications

INVERTER MODEL	1.5K-12V / 1.5K-24V / 3K-24V
Safety Certification	CE
Operating Temperature Range	-20°C to 55°C
Storage temperature	-30°C~ 60°C
Dimension (DxWxH), mm	100 x 272 x 355
Net Weight, kg	7

TROUBLE SHOOTING

Problem	LCD/LED/Buzzer	Explanation / Possible cause	What to do
Unit shuts down automatically during startup process.	LCD/LEDs and buzzer will be active for 3 seconds and then complete off.	The battery voltage is too low (<1.91V/Cell)	1. Re-charge battery. 2. Replace battery.
No response after power on.	No indication.	1. The battery voltage is far too low. (<1.4V/Cell) 2. Battery polarity is connected reversed.	1. Check if batteries and the wiring are connected well. 2. Re-charge battery. 3. Replace battery.
Mains exist but the unit works in battery mode.	Input voltage is displayed as 0 on the LCD and green LED is flashing.	Input protector is tripped	Check if AC breaker is tripped and AC wiring is connected well.
	Green LED is flashing.	Insufficient quality of AC power. (Shore or Generator)	1. Check if AC wires are too thin and/or too long. 2. Check if generator (if applied) is working well or if input voltage range setting is correct. (UPS→Appliance)
	Green LED is flashing.	Set "Solar First" or "SBU" as the priority of output source.	Change output source priority to Utility first.
Buzzer beeps continuously and red LED is on.	Fault code 07	Overload error. The inverter is overload 110% and time is up.	Reduce the connected load by switching off some equipment.
	Fault code 05	Output short circuited.	Check if wiring is connected well and remove abnormal load.
	Fault code 02	Internal temperature of inverter component is over 80°C.	Check whether the air flow of the unit is blocked or whether the ambient temperature is too high.
	Fault code 03	Battery is over-charged.	Return to repair center.
		The battery voltage is too high.	Check if spec and quantity of batteries are meet requirements.
	Fault code 01	Fan fault	Replace the fan.
	Fault code 06/58	Output abnormal.	1. Reduce the connected load. 2. Return to repair center
	Fault code 08/09/53/57	Internal components failed.	Return to repair center.
	Fault code 51	Over current or surge.	Restart the unit, if the error happens again, please return to repair center.
	Fault code 52	Bus voltage is too low.	
	Fault code 55	Output voltage is unbalanced.	
Fault code 56	Battery detection circuit error.	If the battery is connected well, please return to repair center.	