

JENSEN®

DOCKING SPEAKER STATION FOR iPad, iPod AND iPhone

Made for

 iPod  iPhone  iPad



USER MANUAL

JiPS-290i

(iPod/iPhone/iPad Not Included)

PLEASE READ THIS USER MANUAL COMPLETELY BEFORE OPERATING THIS UNIT
AND RETAIN THIS BOOKLET FOR FUTURE REFERENCE.

DEAR JENSEN® CUSTOMER

Selecting fine audio equipment such as the unit you've just purchased is only the start of your musical enjoyment. Now it's time to consider how you can maximize the fun and excitement your equipment offers. This manufacturer and the Electronic Industries Association's Consumer Electronics Group want you to get the most out of your equipment by playing it at a safe level. One that lets the sound come through loud and clear without annoying blaring or distortion and, most importantly, without affecting your sensitive hearing. Sound can be deceiving. Over time your hearing "comfort level" adapts to higher volumes of sound. So what sounds "normal" can actually be loud and harmful to your hearing. Guard against this by setting your equipment at a safe level BEFORE your hearing adapts.

To establish a safe level:

- Start your volume control at a low setting.
- Slowly increase the sound until you can hear it comfortably and clearly, and without distortion.

Once you have established a comfortable sound level:

- Set the dial and leave it there.

Taking a minute to do this now will help to prevent hearing damage or loss in the future. After all, we want you listening for a lifetime.

We Want You Listening For a Lifetime

Used wisely, your new sound equipment will provide a lifetime of fun and enjoyment. Since hearing damage from loud noise is often undetectable until it is too late, this manufacturer and the Electronic Industries Association's Consumer Electronics Group recommend you avoid prolonged exposure to excessive noise.

Customer's Record:

The serial number of this product is found on its back cover. You should note the serial number of this unit in the space provided as a permanent record of your purchase to aid in identification in the event of theft or loss.

Model Number: JiPS-290i

Serial Number: _____

IMPORTANT SAFETY INSTRUCTIONS

When used in the directed manner, this unit has been designed and manufactured to ensure your personal safety. However, improper use can result in potential electrical shock or fire hazards. Please read all safety and operating instructions carefully before installation and use, and keep these instructions handy for future reference. Take special note of all warnings listed in these instructions and on the unit.

1. Read these instructions – All the safety and operating instructions should be read before the appliance is operated.
2. Keep these instructions – The safety and operating instructions should be kept for future reference.
3. Heed all warnings – All warnings on the appliance and in the operating instructions should be adhered to.
4. Follow all instructions – All operation and use instructions should be followed.
5. Do not use this apparatus near water – The appliance should not be used near water; for example, near a bath tub, washbowl, kitchen sink, laundry tub, in a wet basement, or near a swimming pool.
6. Clean only with dry cloth – The appliance should be cleaned only as recommended by the manufacturer.
7. Do not block any ventilation openings. Install in accordance with the manufacturer's instructions. The appliance should be situated so that its location or position does not interfere with its proper ventilation. For example, the appliance should not be situated on a bed, sofa, rug, or similar surface that may block the ventilation openings; or placed in a built-in installation, such as a bookcase or cabinet that may impede the flow of air through the ventilation openings.
8. Do not install near any heat sources such as radiators, heat registers, stoves, or other apparatus (including amplifiers) that produce heat.
9. Protect the power cord from being walked on or pinched particularly at plugs, convenience receptacles, and the point where they exit from the apparatus.
10. The system has an AC plug and will only fit into matching AC outlets. This is a safety feature to reduce the possibility of electric shock. If the plug will not fit in your AC outlets, you should have the outlet changed by qualified licensed electrician. Do not use an adaptor to make the plug fit into your outlet. This defeats the safety feature and could expose you to electric shock.
11. Only use attachments / accessories specified by the manufacturer.
12. Unplug this apparatus during lightning storms or when unused for long periods of time.
13. Refer all servicing to qualified service personnel. Servicing is required when the apparatus has been damaged in any way, such as power-supply cord or plug is damaged, liquid has been spilled or objects have fallen into the apparatus, the apparatus has been exposed to rain or moisture, does not operate normally, or has been dropped.
14. This appliance shall not be exposed to dripping or splashing water and that no object filled with liquids such as vases shall be placed on the apparatus.
15. Power Sources – The appliance should be connected to a power supply only of the type described in the operating instructions or as marked on the appliance. Do not overload wall outlet.
16. Danger of explosion if battery is incorrectly replaced. Replace only with the same or equivalent type.
17. Do not attempt to dismantle, open or repair this product yourself. If a fault occurs, seek advice from your local qualified service technician or contact the distributor via the telephone number at the back of this instruction manual.
18. Caution marking and nameplate are located on back of product.

IMPORTANT NOTES

- For best iPad display clarity, avoid operating the unit in the direct sunlight or under bright light.

Avoid installing the unit in locations described below:

- Places exposed to direct sunlight or close to heat radiating appliances such as electric heaters.
- Places subject to constant vibration.
- Dusty, humid or moist places.
- Sources of electrical noise such as fluorescent lamps or motors.

NOTE: when the system is switched to standby mode, it is still consuming some power. To disconnect the system completely, remove the AC power plug from the wall outlet.

COMPLIANCE WITH FCC REGULATIONS

This device complies with Part 15 of the FCC Rules. Operation is subject to the following two conditions:

- (1) this device may not cause harmful interference, and
- (2) this device must accept any interference received, including interference that may cause undesired operation.

NOTE : This equipment has been tested and found to comply with the limits for a Class B digital device, pursuant to Part 15 of the FCC Rules. These limits are designed to provide reasonable protection against harmful interference in a residential installation. This equipment generates, uses and can radiate radio frequency energy and, if not installed and used in accordance with the instructions, may cause harmful interference to radio communications. However, there is no guarantee that interference will not occur in a particular installation. If this equipment does cause harmful interference to radio or television reception, which can be determined by turning the equipment off and on, the user is encouraged to try to correct the interference by one or more of the following measures:

- Reorient or relocate the receiving antenna.
- Increase the separation between the equipment and receiver.
- Connect the equipment into an outlet on a circuit different from that to which the receiver is connected.
- Consult the dealer or an experienced radio/TV technician for help.

CAUTION: Changes or modifications not expressly approved by the party responsible for compliance could void the user's authority to operate the equipment.

PROTECT YOUR FURNITURE

This model is equipped with non-skid rubber 'feet' to prevent the product from moving when you operate the controls. These 'feet' are made from non-migrating rubber material specially formulated to avoid leaving any marks or stains on your furniture. However certain types of oil based furniture polishes, wood preservatives, or cleaning sprays may cause the rubber 'feet' to soften, and leave marks or a rubber residue on the furniture. To prevent any damage to your furniture we strongly recommend that you purchase small self-adhesive felt pads, available at hardware stores and home improvement centers everywhere, and apply these pads to the bottom of the rubber 'feet' before you place the product on fine wooden furniture.

PRODUCT FEATURES

The JiPS-290i is an iPad / iPod / iPhone Docking Music System with incorporates the following features:

- Play and Charge Your iPad, iPhone, iPod nano, iPod touch.
- Player Only for Your iPod classic and iPod video
- Auxiliary input jack.
- Stereo speakers with subwoofer.
- Video Line-out Connector.

1. STANDARD ACCESSORIES

Carefully remove all the accessories from the display carton. Please verify that you have all the following accessories before you dispose of the carton. Do not remove any labels or stickers on the back panels of the main unit. Place the unit on a level surface such as a table, desk or shelf.

- Instruction manual x 1
- Remote control x 1
- AC Adaptor x 1
- Adjustable Support iPad/iPod/iPhone x 1

2. POWER SOURCE

This Music System operates on 120V AC~ 60Hz household power.

The remote control unit operates on one "CR2025" lithium battery (Included).

CONNECTING THE AC POWER

This system is designed to operate on 120V~ 60Hz household power only. Connecting this system to any other power source may cause damage to the system and such damage is not covered by your warranty.

An AC-DC Adaptor with 10V DC 3400mA output (included) is required for operating the main unit. Connect the AC-DC Adaptor to the unit and an AC outlet:

- 1.) Firmly and securely insert the DC plug of the adaptor into the DC Jack on the unit
- 2.) Plug the Adaptor plug into a power outlet rated at 120V AC~ 60Hz.

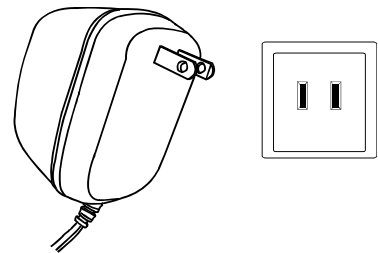

CAUTION: The system has an AC plug and will only fit into matching AC outlets. This is a safety feature to reduce the possibility of electric shock. If the plug will not fit in your AC outlets, you should have the outlet changed by a qualified, licensed electrician. Do not use an adaptor to make the plug fit into your outlet. This defeats the safety feature and could expose you to electric shock.

NOTE: This unit is not magnetically shielded and may cause color distortion on the screen of some TVs or video monitors. To avoid this, you may need to move the unit further away from the TV or monitor if unnatural color shifts or image distortion occurs.

REMOTE CONTROL

The remote control works on one 3V  "CR2025 type" lithium battery (included). To activate the remote control, remove the insulation tab inserted in the battery compartment. To remove the tab, pull it in the direction of the arrow as shown in the illustration.

If the operation of the remote control becomes unsatisfactory, replace the original battery with a new 3-volt lithium battery of the same type.

1. Slide out the battery holder from the remote control case. (Push tab "A" towards the middle first, see diagram).
2. Replace the weak/dead battery with a new one. Be sure the battery is installed correctly. The remote control will not work if the battery is installed with wrong polarity,

CAUTION: Danger of explosion if the battery is replaced incorrectly. Replace only with the same or equivalent type of battery.

3. Insert the battery holder back into the battery slot.

NOTE: Only use a well-known brand of cell battery to ensure the longest life and best performance.

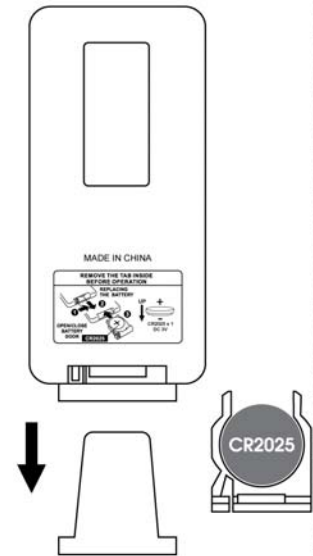

BATTERY CARE

- i. If the unit is not used for an extended period of time, remove the battery. An old or leaking battery can cause damage to the unit and may void the warranty.
- ii. Do not dispose batteries in fire. Batteries may leak or explode.
- iii. Do not try to recharge batteries that are not intended to be recharged; they can overheat, rupture and leak (Follow battery manufacturer's directions).
- iv. Only an adult should replace the battery. Do not leave it lying around where a young child or pet could play with or swallow it.

FRONT PANEL OF THE UNIT

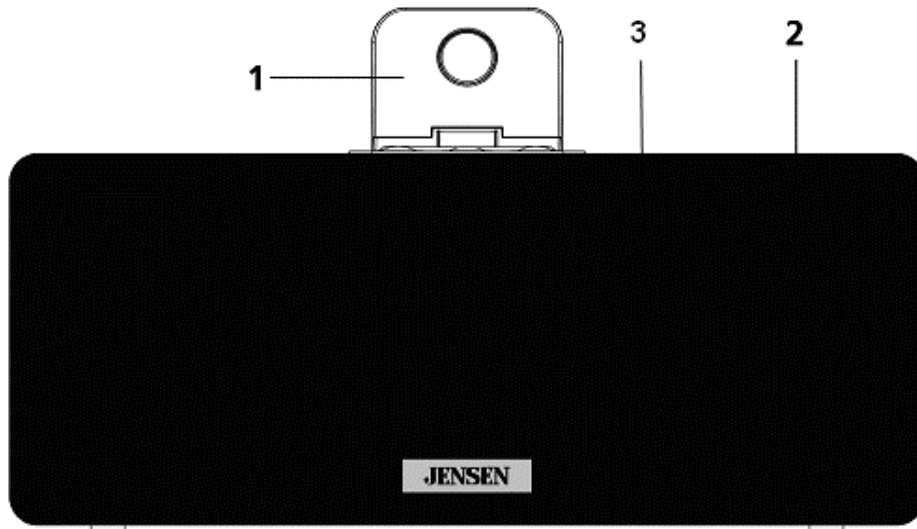

- 1.) Adjustable Support for iPad/iPod/iPhone
- 2.) Speaker Grill
- 3.) Remote Control Sensor

TOP PANEL OF THE UNIT

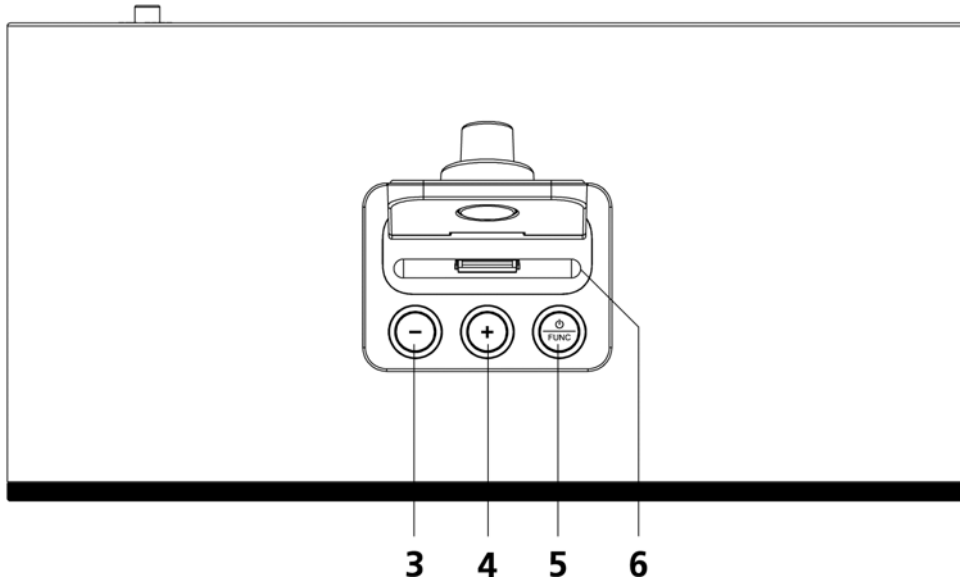

- 3.) VOLUME Down (-) Button
- 4.) VOLUME Up (+) Button
- 5.) POWER ⏻ ON/STANDBY; iPod/AUX FUNCTION select Button
- 6.) iPad/iPod/iPhone Dock Connector

REAR PANEL OF THE UNIT

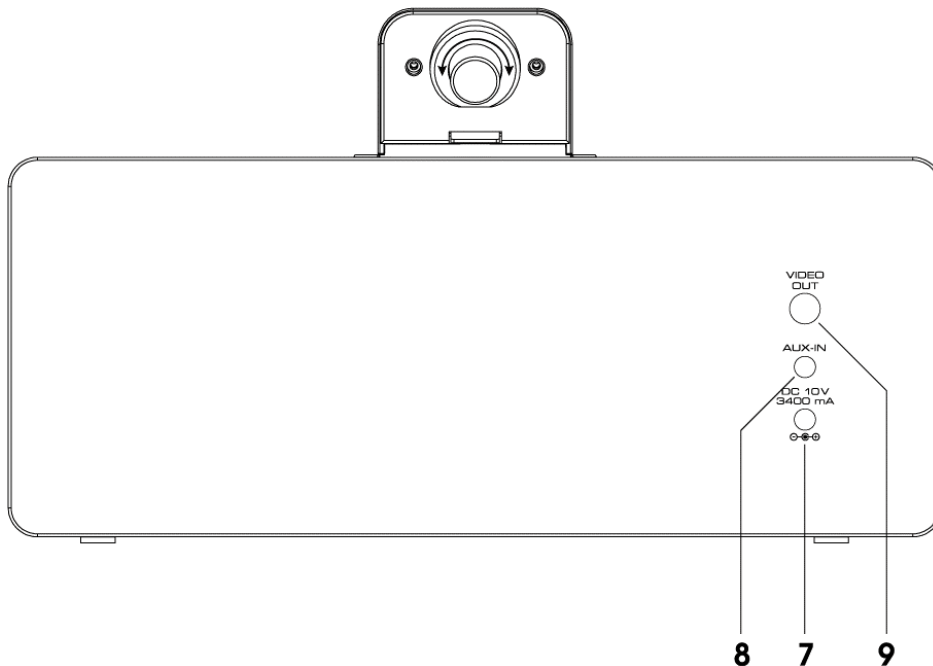

- 7.) DC IN Jack

- 8.) AUX IN Jack
- 9.) Composite Video Out Connector

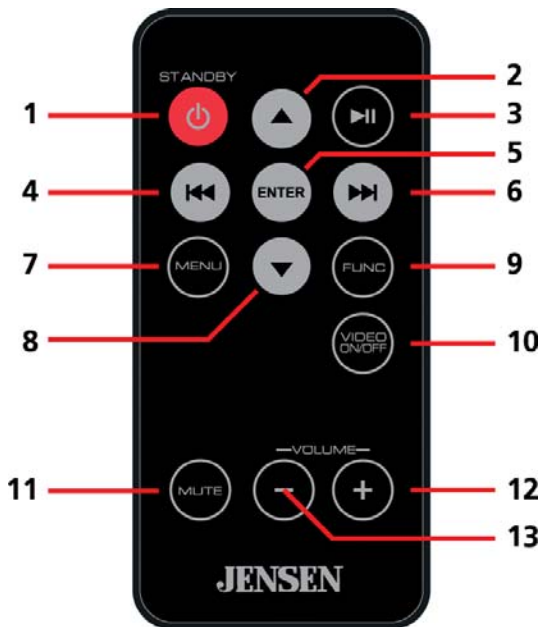

REMOTE CONTROL

- 1.) POWER ON/STANDBY Button
- 2.) iPod MENU UP Button
- 3.) PLAY / PAUSE Button
- 4.) SKIP/FAST BACKWARD Button
- 5.) ENTER Button
- 6.) SKIP/FAST FORWARD Button
- 7.) iPod MENU Button
- 8.) iPod MENU DOWN Button
- 9.) FUNCTION Button
- 10.) VIDEO ON/OFF Button
- 11.) MUTE Button
- 12.) VOLUME Up (+) Button
- 13.) VOLUME Down (-) Button



BASIC OPERATION

Turning on/off the unit

- 1). Press the POWER ON/STANDBY button on the remote control or  button on main unit to turn on the unit. The rings around the POWER and VOLUME Up/Down Buttons will light solid blue for iPad/iPod/iPhone mode or will flash blue every 4 seconds in AUX mode.
- 2). Press the remote POWER ON/STANDBY button again or press and hold the  button on main unit to switch the unit to standby mode.

Notes:

- Make sure the AC power cord from this unit is properly connected to a 120V~ 60Hz household AC power outlet.
- Make sure that the minimum distance around the whole unit for ventilation is 10cm.

Function mode selection

Press the FUNC button on the remote control or tap the FUNC button on top panel of the unit to select iPod or AUX Mode.

iPad/iPod/iPhone mode - The blue rings around the VOLUME Up/Down and POWER buttons light solid.

AUX mode – The blue rings around the VOLUME Up/Down and POWER buttons will flash every 4 seconds.

Volume Up(+) / Down(-) control

Press the VOLUME Up(+) / Down(-) button on the remote control or main unit to adjust the volume to desired sound level.

Operating the MUTE function

When listening to an iPad/iPod/iPhone or while using the AUX IN, press the MUTE button on the remote to activate the mute function, the blue rings around the POWER and VOLUME Up/Down Buttons will begin flashing rapidly. The speaker sound is temporarily muted. Press the Mute button again to cancel the mute function or press the VOLUME+/- button to resume the normal playback mode.

Mounting the iPad, iPod and iPhone Adjustable Support

The unit comes with an adjustable support for the back of the iPad/iPod/iPhone to rest on when docked. Attach the adjustable support by sliding it onto the mounting bracket located behind the 30-pin connector as shown below. Make sure the adjustable support locks firmly into place before docking ANY iPod, iPad or iPhone to avoid damage the 30 pin connector.

Note: Do not attempt to dock your Apple device onto the unit before this adjustable support has been securely attached. It may damage the 30-pin connector of the unit and such damage is not covered by your warranty.

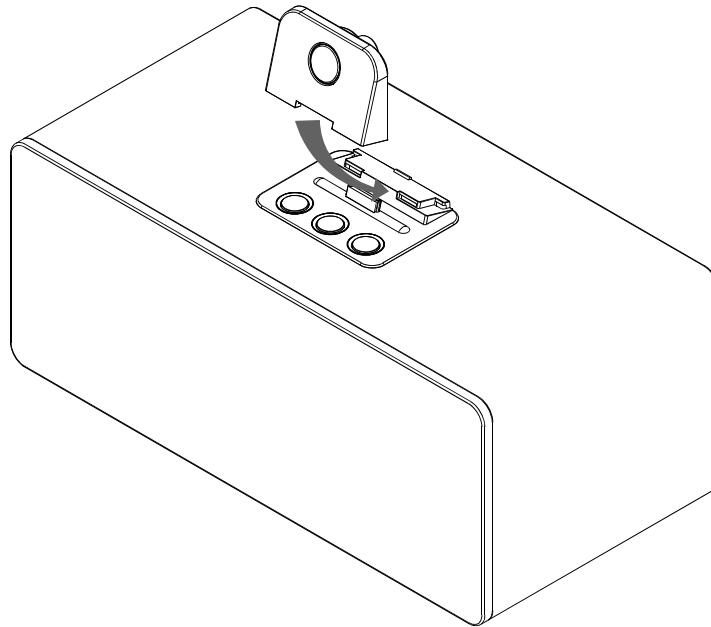

CAUTION

The Adjustable Support for the iPad, iPod and iPhone is not designed to be removed once it's installed.

Adjust the position of the support by turning the barrel shaped knob (located on the back of the assembly) either clockwise or counter-clockwise until the front padded part of the barrel touches the back of your iPad, iPod or Phone. The barrel shaped knob will move forward or back as it's turned. The Apple device should be angled slightly backwards to secure the docking.

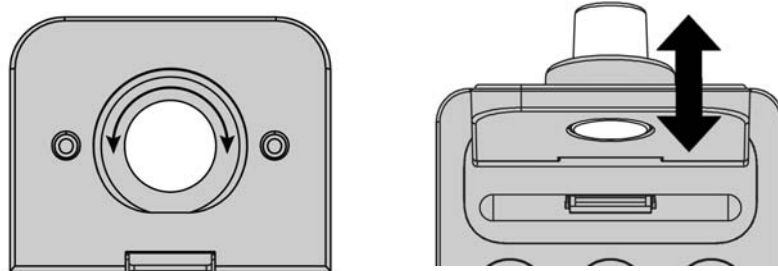

LISTENING TO YOUR iPad/iPod/iPhone

RECHARGING YOUR APPLE DEVICE



This unit supports various models of iPad, iPod or iPhone with 30-pin dock connectors. Even if the Dock is in standby mode, once your iPad, iPod or iPhone is docked onto the docking connector, the charging will start automatically.

Note: Due to a change in iPod design, the charging function of this unit does not support the iPod classic or 5th gen iPod video.

CONNECTING

- 1). Place your iPad/iPod/iPhone into the docking port by placing the connector on the bottom of the iPad/iPod/iPhone onto the connector in the docking bay.

Note: Please be careful when placing the iPad/iPod/iPhone into the docking bay to avoid damaging the 30-pin connector on the iPad/iPod/iPhone or on the docking system.

- 2). Press the POWER  button to turn on the unit, the blue rings around the VOLUME Up/Down and POWER buttons light solid. If the unit is in AUX mode, the blue rings around the VOLUME Up/Down and POWER buttons flash every 4 seconds. Press the FUNC button on remote control or tap the FUNC button on the main unit to select iPod/iPad/iPhone mode, the blue LED rings will light solid.
- 3) Select music from your iPad, iPod or iPhone and press the PLAY/PAUSE button on the remote to start playback.
- 4). Press the PLAY/PAUSE button on the remote control to pause the play back. Press it again to resume.
- 5). Adjust the sound level by pressing the Volume + / – buttons.
Note: The volume level cannot be adjusted using the volume control on your iPad/iPod/iPhone after being docked.
- 6). Press SKIP/FAST FORWARD or BACKWARD button on the remote control to select the previous or next song.
- 7). Press the STANDBY button on the remote control or press and hold the  / FUNC button for 5 seconds to turn the unit to STANDBY mode after listening.

iPad/iPod/iPhone PLAYBACK (By Remote Control):

- Press the PLAY/PAUSE ►||| button to pause or resume the iPad/iPod/iPhone playback;
- Press the SKIP ◀◀ or ▶▶ buttons to skip to the next or previous song;
- Press and hold the SKIP ◀◀ or ▶▶ buttons for fast-forwarding or fast-rewinding during playback.
- From the remote, press the **MENU** button, **ENTER** button and ▲/▼ buttons on the remote control to control the iPod menu, scroll menu up/down and enter selection.

- Note:** 1. The iPod Menu Control function will work with most iPod touch/iPhone models in iPod mode. Please make sure your iPod/iPad/iPhone is in **iPod/iPad/iPhone mode**. The function will NOT work if the iPod/iPad/iPhone is in **MAIN** or **LOCKED** screen.
2. The iPod menu navigating function of remote control will work on most iPhone or iPod models except for the iPod nano 6th gen.

WATCH VIDEOS ON YOUR iPad

1. Dock your iPad carefully and securely onto the Docking Connector.
2. Press the POWER button on the main unit or remote to turn on the unit.
3. Access the video menu of your iPad and select the video clip you want to play.
4. Tap the Play icon on your iPad touch screen, the video will start play back on the LCD screen of your iPad.
5. You can additionally watch your favorite Youtube videos when you are connected to the internet via Wi-Fi, 2G or 3G cell phone networks.
6. High quality audio output from your videos will be playback through the built-in stereo speakers.
7. After selecting the video you wish to view and it starts to play, press the Play/Pause ►||| Button on remote to play or pause.
8. Press the ▶▶ Button to advance to end of the current clip. Press and hold it during playback for fast forward search within the clip.
9. Press the ◀◀ Button to go to the start of current clip. Press and hold it during playback for fast backward search within the clip.
10. Press the Volume Up (+) and Volume Down (-) buttons on the unit or remote to adjust the volume output level.
11. Press the Mute Button of the remote to cut off the audio output from the speakers. Press again to resume listening.

Note: The fast forward /reverse functions may not work for Youtube videos.

HOW TO WATCH VIDEOS ON A TV

1. Connect the Video Out Jack of the JiPS-290i to the composite video input of your external TV with a suitable video cable (not included).
2. Securely dock your iPad, iPod or iPhone with video.
3. Press the POWER button to turn on the unit and access the video menu of your Apple device and select the video clip you want to play. It will be played back on the LCD screen of your Apple device.

Note: For the iPod nano (3rd generation and up), iPod video and iPod classic, select the “Videos” or “Podcasts” menu to locate your favorite video clips on the Apple device’s LCD screen.

4. Press the Play/Pause button on remote to play or pause.
5. The remote control features a “Video On/Off” Button. If you are using iPad, iPod touch or iPhone, pressing the Video On/Off Button once when the remote is pointing towards the IR Sensor on the main unit, will change how the video is displayed.
6. Tap the Apple device’s screen or press the MENU ▲/▼ buttons on the remote control to select the video you want to play and then press the ENTER button. Your Apple device will show “TV Connected” message on its screen and the video will begin playing on the external TV screen.

Note: MEMU ▲/▼ buttons on the remote control may not work for your iPad.

7. The video can be switched between the local Apple device screen (default) and Video-out by pressing VIDEO ON/OFF button and then select a video from video library to play.

Note: 1). If you are using iPad, you can simple press the VIDEO ON/OFF button and then Play/Pause button to switch video play back on iPad's screen or TV.

2). If you are using the iPod nano, iPod classic or iPod video, VIDEO ON/OFF button will be no function for these iPod models, you need to turn on the TV Out option manually from the video setting menu of your iPod.

8. Press the VOLUME Up (+) / Down (-) buttons on the unit or remote to adjust the sound output level.

Note: If you remove the iPad / iPod / iPhone from the docking connector and dock it again later, the Apple device will revert back to its default play mode and play videos on the screen of the Apple device. You need to follow above instructions again to set TV Out of your Apple device if you want to watch its videos on a TV.

AUXILIARY INPUT

This unit provides an auxiliary audio signal input jack for connecting external audio devices like MP3 players, CD players and older, non-dockable iPods (except iPod shuffle 3rd gen) and listen to your external source through the speakers of this system.

1. Use an audio cable (not included) with one 3.5 mm stereo plug on each end of the cable.

2. Plug one end into the Aux-in jack on the main unit and the other end of the cable into the Line-out Jack or Headphone Jack of your external audio device.

3. Turn on the external audio device.

4. To select auxiliary audio input, press the FUNCTION button to select "AUX" mode. the blue rings around the VOLUME Up/Down and POWER buttons flash every 4 seconds.

5. The volume level can now be controlled through the main unit. Operate all other functions on the auxiliary device as usual.

Note:

(1) If you connected the Line Out Jack of your external device then you only need to adjust the volume control of this system. If you connected the Headphone Jack of your external device then you may need to adjust both the volume control of your external device and the volume control of this system to find the most desirable volume setting.

(2) Press the POWER  button to turning off the system when you finish listening. Don't forget to switch off the power of your external device as well.

RESETTING

If the system does not respond or has erratic or intermittent operation, you may have experienced an electrostatic discharge (ESD) or a power surge that triggered the internal computer to shut down automatically. If this occurs, simply disconnect the main power, wait one minute and reconnect the main power again.

CARE AND MAINTENANCE

1. Avoid operating your unit under direct sunlight or in hot, humid or dusty places.
2. Keep your unit away from heating appliances and sources of electrical noise such as fluorescent lamps or motors.
3. For better Clock Display clarity, avoid operating the unit under direct sunlight or in strong room illumination.
4. Unplug the unit from the electrical power outlet immediately in case of malfunction.

CLEANING THE UNIT

- To prevent fire or shock hazard, disconnect your unit from the AC power source when cleaning.
- The finish on the unit may be cleaned with a dust cloth and cared for as other furniture, Use caution when cleaning and wiping the plastic parts.
- If the cabinet becomes dusty wipe it with a soft dry dust cloth. Do not use any wax or polish sprays on the cabinet.
- If the front panel becomes dirty or smudged with fingerprints it may be cleaned with a soft cloth slightly dampened with a mild soap and water solution. Never use abrasive cloths or polishes as these will damage the finish of your unit.

CAUTION: Never allow any water or other liquids to get inside the unit while cleaning.

Symptom	Possible Problem	Solution
The unit does not respond (no power).	AC Adaptor is not plugged into a wall outlet or the connector is not plugged into the power supply jack on the back of the unit.	Plug the AC adaptor into a wall outlet and plug the connector into the supply jack on the unit.
	Wall outlet is not functioning.	Plug another device into the same outlet to confirm the outlet is working.
iPad/iPod/iPhone does not respond to the speaker system.	iPad/iPod/iPhone is not installed properly.	Remove your iPad/iPod/iPhone from the dock and check for obstruction on the connectors in the dock and on your iPad/iPod/iPhone. Then reseat it on the dock.
	Your iPad/iPod/iPhone is locked up.	Please make sure that your iPad/iPod/iPhone is working properly before docking into the unit. Please refer to your iPad/iPod/iPhone manual for info on resetting the iPad/iPod/iPhone.
	Unit not in iPad/iPod/iPhone mode	Make sure the function is set to iPad/iPod/iPhone mode.
iPad/iPod/iPhone does not charge.	iPad/iPod/iPhone is not installed properly.	Remove your iPad/iPod/iPhone from the dock and check for obstruction on the connectors in the dock and on your iPad/iPod/iPhone. Then reseat it in the dock.
	iPad/iPod/iPhone is locked up/ frozen. iPad/iPod/iPhone battery has problem.	Please make sure your iPad/iPod/iPhone is working properly before docking into the unit. Please refer to your iPad/iPod/iPhone manual for details on resetting.
Remote control No functions or short range.	Battery exhausted	- Insert new batteries. - Aim remote directly towards the remote sensor.

Sound is distorted.	Volume level is set too high.	Decrease the volume.
	Sound source is distorted.	If the iPad/iPod/iPhone original sound source is of poor quality, distortion and noise are easily noticed with high-power speakers. Try a different audio source such as a music CD.
		If you are using an external sound source like older generation of iPod, try reducing the output volume on the device itself. Also try turning bass boost OFF or change the EQ setting.
Unit gets warm after extended play at high volume.	This is normal.	Turn the unit off for a period of time or lower volume.

Power Requirement

Main Unit AC-DC Adaptor: Input: AC 120V, 60Hz
Output: DC 10V, 3400 mA

Remote Control 1 X 3V CR2025 Lithium Battery

“Made for iPod,” “Made for iPhone,” and “Made for iPad” mean that an electronic accessory has been designed to connect specifically to iPod, iPhone, or iPad, respectively, and has been certified by the developer to meet Apple performance standards. Apple is not responsible for the operation of this device or its compliance with safety and regulatory standards. Please note that the use of this accessory with iPod, iPhone, or iPad may affect wireless performance.

iPad, iPhone, iPod, iPod classic, iPod nano, iPod shuffle, and iPod touch are trademarks of Apple Inc., registered in the U.S. and other countries.



At Spectra, environmental and social responsibility is a core value of our business. We are dedicated to continuous implementation of responsible initiatives with an aim to conserve and maintain the environment through responsible recycling.

Please visit us at <http://www.spectrainl.com/green.htm> for more information on Spectra’s green initiatives or to find a recycler in your area.

**90 DAY LIMITED WARRANTY AND SERVICE
VALID IN THE U.S.A ONLY**

SPECTRA MERCHANDISING INTERNATIONAL, INC. warrants this unit to be free from defective materials or factory workmanship for a period of 90 days from the date of original customer purchase and provided the product is utilized within the U.S.A. This warranty is not assignable or transferable. Our obligation under this warranty is the repair or replacement of the defective unit or any part thereof, except batteries, when it is returned to the SPECTRA Service Department, accompanied by proof of the date of original consumer purchase, such as a duplicate copy of a sales receipt.

You must pay all shipping charges required to ship the product to SPECTRA for warranty service. If the product is repaired or replaced under warranty, the return charges will be at SPECTRA's expense. There are no other express warranties other than those stated herein.

This warranty is valid only in accordance with the conditions set forth below:

1. The warranty applies to the SPECTRA product only while:
 - a. It remains in the possession of the original purchaser and proof of purchase is demonstrated.
 - b. It has not been subjected to accident, misuse, abuse, improper service, usage outside the descriptions and warnings covered within the user manual or non-SPECTRA approved modifications.
 - c. Claims are made within the warranty period.
2. This warranty does not cover damage or equipment failure caused by electrical wiring not in compliance with electrical codes or SPECTRA user manual specifications, or failure to provide reasonable care and necessary maintenance as outlined in the user manual.
3. Warranty of all SPECTRA products applies to residential use only and is void when products are used in a nonresidential environment or installed outside the United States.

This warranty gives you specific legal rights, and you may also have other rights which vary from state to state. TO OBTAIN SERVICE please remove all batteries (if any) and pack the unit carefully and send it freight prepaid to SPECTRA at the address shown below. IF THE UNIT IS RETURNED WITHIN THE WARRANTY PERIOD shown above, please include a proof of purchase (dated cash register receipt) so that we may establish your eligibility for warranty service and repair of the unit without cost. Also include a note with a description explaining how the unit is defective. A customer service representative may need to contact you regarding the status of your repair, so please include your name, address, phone number and email address to expedite the process.

IF THE UNIT IS OUTSIDE THE WARRANTY PERIOD, please include a check for \$50.00 to cover the cost of repair, handling and return postage. All out of warranty returns must be sent prepaid.

It is recommended that you contact SPECTRA first at 1-800-777-5331 or by email at custserv@spectraintl.com for updated information on the unit requiring service. In some cases the model you have may be discontinued, and SPECTRA reserves the right to offer alternative options for repair or replacement.

SPECTRA MERCHANDISING INTERNATIONAL, INC.
4230 North Normandy Avenue,
Chicago, IL60634, USA.
1-800-777-5331

To register your product, visit the link on the website below to enter your information.

<http://www.spectraintl.com/wform.htm>

Printed in China