

INSTRUCTIONS FOR USE

INSTALLATION INSTRUCTIONS

ABSORPTION - REFRIGERATOR for CARAVAN and MOTORHOME

RM 7271 L
RM 7275 L
RM 7291 L
RM 7295 L
RM 7361 L
RM 7365 L
RM 7371 L
RM 7401 L
RM 7405 L



Record for future reference:

Model number
Product number
Serial number



English

Type C40 / 110
822 6100 - 52

T.B. 09/2005





Safety instructions

Instructions for storing food in a refrigerator:

No refrigerator of any kind can improve the quality of the food; refrigerators can only maintain the food's quality for a short duration as from the time of storing it.

Please observe the following particular conditions for storing food in a refrigerator that is built into a vehicle:

- A change in the climatic conditions such as temperature fluctuations
 - High temperatures inside the vehicle when it is closed and parked in direct sunlight (temperatures are possible up to 50°C)
 - Use of the refrigerator whilst travelling with the power supply of 12V--DC
 - A refrigerator built in behind a window and exposed to direct sunlight
 - Storing the goods too soon, i.e. shortly after switching the device on for use
- Under these particular conditions the refrigerator cannot guarantee having the temperature needed for food that perishes quickly.

Foods that perish quickly include: all the products with a stipulated use-by date and a minimum storage temperature of +4°C or less, especially for meat, poultry, fish, sausage, pre-packed foods.

Instructions

- Pack raw and cooked foods separately (e.g. in containers, aluminium foil, etc.)
- Only remove the outside packaging of single packs if all the necessary data, such as the use-by date, for example, can also be read on the single packs.
- Do not leave cooled goods outside the refrigerator for too long.
- Place the foods with the next use-by date at the front, accordingly.
- Pack away any left-over food again and eat at the first opportunity.
- Wash your hands before and after touching any food.
- Clean the inside of the refrigerator at regular intervals.

Information :

Please observe the instructions and information regarding the use-by date on the outside packaging of the food.

Please observe the following sections in these instructions: "5.1 Cleaning" and "5.3 Storing food".

**These operating instructions should be kept in a safe place.
If this device is passed on, please include these operating instructions with it.**

TABLE OF CONTENTS

1.0	INTRODUCTION	4
2.0	FOR YOUR SAFETY	4
2.1	Warning and safety notices	4
2.2	Coolant	4
3.0	WARRANTY AND CUSTOMER SERVICE	5
3.1	Damage in transit	5
4.0	DESCRIPTION OF MODEL	5
5.0	REFRIGERATOR GUIDE	5
5.1	Cleaning	5
5.2	Using the refrigerator	6
5.3	Storing food	10
5.4	Making ice cubes	11
5.5	Defrosting	11
5.6	Positioning the storage racks	11
5.7	Door locking	12
5.8	Switching off the refrigerator	12
5.9	Winter operation	12
5.10	Interior light	13
5.11	Changing the decor panel	13
5.12	Changing the doorhang	14
5.13	Troubleshooting	15
5.14	Maintenance	16
5.15	Product liability	16
5.16	Environmental hints	16
5.17	Disposal	16
5.18	Energy-saving tips	16
5.19	Technical data	17
5.19	Connecting points	17
6.0	INSTALLATION GUIDE	18
6.1	Installation	18
6.2	Draught-free installation	19
6.3	Ventilation and air extraction	20
6.4	Installation of the ventilation system	21
6.5	Installation recess	22
6.6	Securing the refrigerator	22
6.7	Fume extraction	23
6.8	Gas installation	24
6.9	Electrical installation	25



Information



Environmental
Advice



Attention



Warning

1.0

INTRODUCTION

You have made an excellent choice in selecting the **Dometic Absorption Refrigerator**. We are sure that you will be fully satisfied with your new appliance in all respects. The appliance, which works silently, meets high quality standards and guarantees the efficient utilisation of resources and energy throughout its entire life cycle, during manufacture, in use and when being disposed of.

Before you start to use the appliance, please read the installation and operating instructions carefully.

The refrigerator is designed for installation in leisure vehicles such as caravans or motorcaravans. The appliance has been certified by The Australian Gas Association.

2.0

FOR YOUR SAFETY

2.1



Danger



Attention

Warning and safety notices



- **Never use a naked flame to check the appliance for leaks.**

- **Protect children!**

When disposing of the refrigerator, remove all refrigerator doors and leave the storage rack in the refrigerator. This will prevent accidental locking in or suffocation.

- If you smell gas:

- Close the locking tap of the gas supply and the valve on the cylinder.
- Open the windows and leave the room.
- Do not switch on anything electrical.
- Extinguish naked flames.

- Never open the cooling unit; it is under high pressure.

- **Work on the gas, flue system and electrical components must only be carried out by qualified service personnel.**

- It is imperative that the operating pressure should correspond to the data given on the model plate of the appliance.

- Compare the operating pressure data given on the model plate with the data on the pressure monitor of the liquid gas cylinder.

- Gas operation of the appliance is not permitted while travelling on ferries.

- Covers ensure electrical safety and must only be removed using a tool.

- The appliance must not be exposed to rain.

- **The refrigerator is not suitable for the proper storage of medications.**

2.2

Coolant

Ammonia is used as a coolant.

This is a natural compound also used in household cleaning agents (1 litre of Salmiak cleaner contains up to 200g of ammonia - about twice as much as is used in the refrigerator). Sodium chromate is used for corrosion protection (1.8% of the solvent).

In the event of leakage (easily identifiable from the unpleasant odour):

- Switch off the appliance.
- Air the room thoroughly.
- Inform the authorised Customer Service department.

3.0

WARRANTY AND CUSTOMER SERVICE

Warranty arrangements are in accordance with the normal conditions applicable for the country concerned.

For warranty or other servicing, please contact our Dometic Service department. Any damage due to improper use is not covered by the warranty. The warranty does not cover any modifications to the appliance or the use of non-original Dometic parts; the warranty does not apply if the installation and operating instructions are not adhered to and no liability shall be entertained.

When contacting Dometic Service, please state the model, product number and serial number together with the MLC Code, if applicable. You will find this information on the data plate inside the refrigerator.

3.1

Damage in transit

After removing the packaging, check whether the refrigerator has been damaged during transportation.

Any damage sustained in transit must be reported to the transportation company concerned no later than seven days after delivery of the goods.

4.0

DESCRIPTION OF MODEL

e.g. RM 7401 L — “L” with interior light

Refrigerator Mobile /
Mobile Absorption Refrigerator

Last digit 1 = manual energy selection
Last digit 5 = automatic and manual energy selection

5.0

REFRIGERATOR GUIDE

5.1

Cleaning

Before switching the refrigerator on to use it, we recommend that you clean it inside and out, and repeat this at regular intervals.

- Use a soft cloth and lukewarm water with a mild detergent.
- Then rinse the appliance with clean water and dry thoroughly.
- Remove dust from the refrigerator unit at yearly intervals using a brush or soft cloth.

ATTENTION

To avoid deterioration of materials:

- Do not use soap or hard, abrasive or soda-based cleaning agents.
- Do not allow the door seal to come into contact with oil or grease.

5.2

Using the refrigerator

- i** • The cooling unit is silent in operation.
- When the appliance is first put into operation, there may be a mild odour which will disappear after a few hours. Ensure the living area is well ventilated.
- The refrigerator will take several hours to reach its operating temperature in the cooling compartment
The freezer compartment should be cold about one hour after switching on the refrigerator.

5.2.1

Controls

A. Manual energy selection *MES* (e.g. RM 7XX1 L)

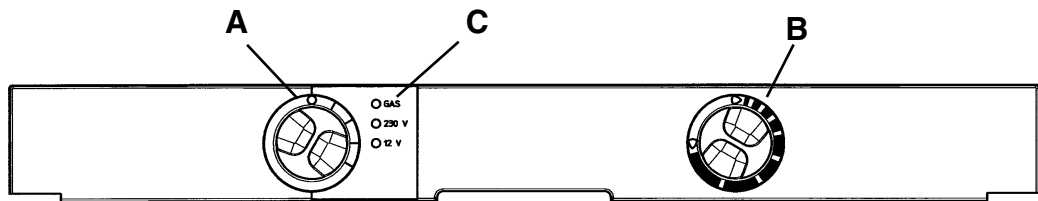

- A** = energy selection switch
- B** = gas/electric thermostat AC/DC
- C** = operating displays (3 LEDs)

B. Automatic and manual energy selection *AES* (e.g. RM 7XX5 L)

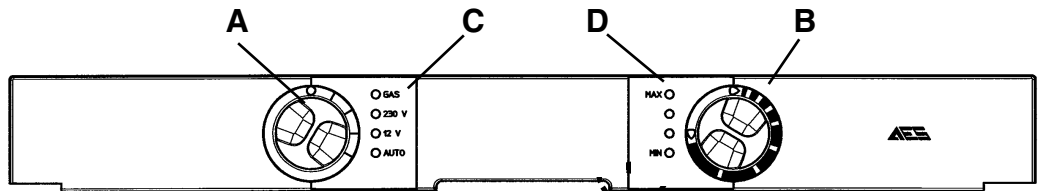

- A** = energy selection switch
- B** = gas/electric thermostat AC/DC
- C** = operating displays (4 LEDs)
- D** = temperature setting display
- E** = dimmer for LED-displays (only accessible when door opens)

Note:

The refrigerator is equipped to operate on mains power, DC or liquid gas (propane/ butane). The desired power option is selected by means of energy selector switch (**A**). Energy selector switch (**A**) has four settings: **AC** mains power, **DC** (12V), **Gas** (liquid gas), **OFF**.

Appliances with automatic energy selection have the additional setting "AUTO" .

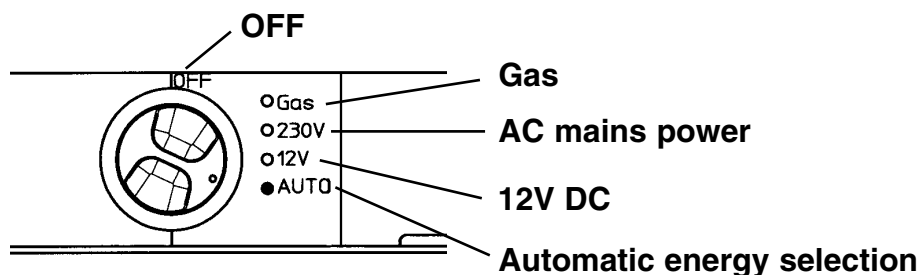

Proceed to the description that applies to YOUR model.

A. Manual Energy Selection

5.2.2

Electrical operation

1. 12V - operation (DC)

 The refrigerator should only be used while the motor is running, otherwise the on-board-battery would be discharged within a few hours!

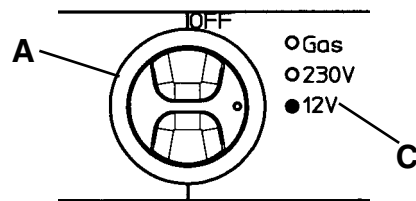

1. Set energy selector switch (A) to 12V .
Operating display "C", 12V lights "green".
Appliance is in function.

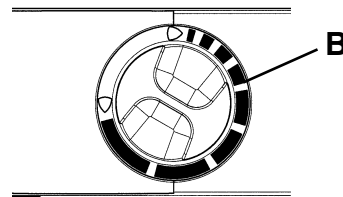

2. Use rotary switch (B) to regulate the temperature in the main refrigerator compartment.

 If the operating display fails to light up (it lights up "red" at **AES** models) the device is not in operation. (For troubleshooting see 5.13)

2. Mains power

This option should only be selected where the supply voltage of the connection for power supply corresponds to the value specified on the data plate. Any difference in values may result in damage the appliance.

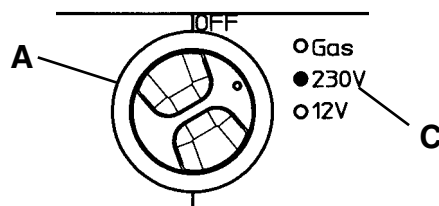

1. Set energy selector switch (A) to 230V .
Operating display "C", 230V lights "green".
Appliance is in function.

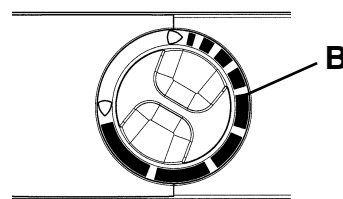

2. Use rotary switch (B) to regulate the temperature in the main refrigerator compartment.

 If the operating display fails to light up (it lights up "red" at **AES** models) the device is not in operation. (For troubleshooting see 5.13)

5.2.3

Gas operation



- The refrigerator should only be operated using liquid gas (propane). Do not use Autogas, town gas or natural gas.
- If the refrigerator is operated during travel using gas, the precautions stipulated by the legislation in the respective country must be taken. Operating the refrigerator with gas is not permitted during travel in France and Australia.



- As a basic rule, operation using gas is prohibited in petrol stations.

1. Open the valve of the gas cylinder
2. Open the shut-off valve to the gas supply.

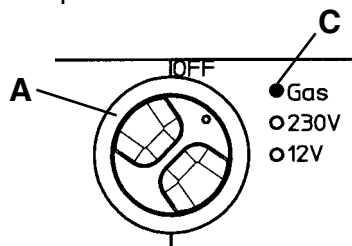

1. Set energy selector switch (A) to gas

2. Set rotary switch (B) to "MAX" position.

The ignition process is activated automatically, accompanied by a ticking sound approx. 30 sec. Upon successful ignition, the display LED (C) "Gas" lights yellow. The refrigerator is in function. Use rotary switch (B) to regulate the temperature in the main refrigerator compartment.

5.2.4

Gas faults

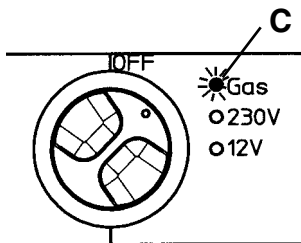

In the event of a gas fault (e.g. gas cylinder empty), the operating display (C) flashes **yellow**.

Remedies:

Set the energy selector switch (A) to position "OFF".

1. Is there any gas in the gas bottle?
2. Is the gas bottle valve open?
3. Is the on-board shut-off valve open?
4. Set the main switch (A) to "on"

The reignition starts again.

If after about 30 seconds the operating display (C) starts flashing red again, the gas fault has not been cleared (e.g. air in the gas pipe).

5. Briefly switch the refrigerator off and then on again using main switch (A).
To remove air from the gas pipes, repeat this procedure 3-4 times.

If these actions do not help, please call an authorised Dometic Service Centre.

B. Automatic Energy Selection (only with RM 7XX5 L)

5.2.5

“AUTO”-operation

RM7XX5 L - models are equipped with an “**AUTO**”-MATIC function.

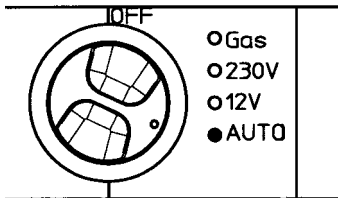

Set energy selection switch (A) to position “AUTO” .

The LED "AUTO" illuminates.

i Manual operation is possible at any time.

Explanations:

Upon switching on, the electronics automatically select one of the three possible energy types: **230V** - **12V** - **liquid gas**. The control electronics automatically ensure that the refrigerator is supplied with the optimum source of energy in each respective case.

- | | |
|-----------------|---------------------------|
| Priority | 1.) Solar (12V DC) |
| | 2.) 230V AC |
| | 3.) 12V DC |
| | 4.) Liquid gas |

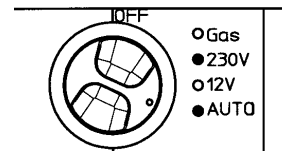

The selected energy is displayed by the corresponding LED (i.e. 230V).

230 V - operation

If sufficient supply voltage is available (more than 200V), this power source is selected as the first option (no solar-system installed).

12 V - operation

12V operation should only be selected while the vehicle motor is running or there is sufficient voltage available from the solar system. This can be detected from the D+ connection of the alternator to the electronics, or from the respective signal on the solar charge regulator.

Gas operation

Gas operation is selected in the following circumstances:

- No supply voltage available.
 - The vehicle engine is not running.
 - Supply voltage less than 200V
- Gasfaults at “AUTO” - mode see “5.2.4”

i **△** REFUELLING STOP

In order to prevent unintended switching to gas operation during refuelling, the electronic system starts gas operation of the refrigerator, after the motor has been turned off for 15 mins. During this time the appliance is in stand-by operation mode and only the "AUTO" LED lights up.

The use of naked flames is prohibited in petrol station environments.
If the refuelling stop lasts longer than 15 mins., the refrigerator should be switched off at the main switch (A), or switched over to another energy type.

5.2.6

Additional functions (RM 7XX5 L - models only)

- Temperature setting display (D) with 4 LED to indicate the selected temperature (MIN - MAX)
- LED - dimmer (E) for adjusting the brightness of the display-LED (only accessible when door opens)

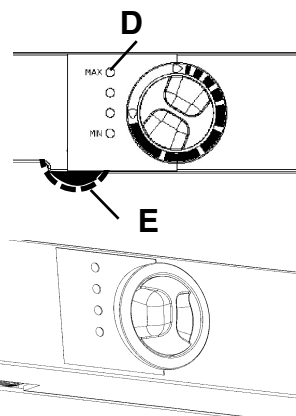

Underneath the fascia is a knurled knob for adjusting the brightness (see item E above)

5.2.7

Temperature setting cooling compartment

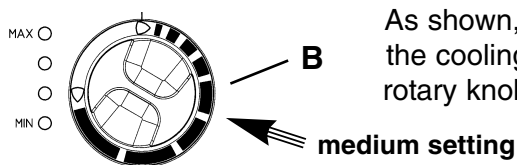

As shown, you are able to regulate the temperature of the cooling compartment, if necessary, by turning rotary knob (B) .



The cooling unit's performance is influenced by ambient temperatures.



Please select the **medium setting** for ambient temperatures between 59°F and 77°F. The unit operates within its optimum performance range.



DOMETIC refrigerators work according to the absorption principle.

Due to physical reasons, an absorption system responds slowly to changes made on the thermostat controller, or a loss in cooling through opening the door, or storing food. The devices fulfill the cooling performance requirements of the Climatic Class SN acc. to EN/ISO 7371 in the temperature range of 50°F to 89°F ambient temperature.

5.3

△ Storing food

- Switch the refrigerator on approx. 12 hours before filling it.
- Always store pre-cooled foods in the refrigerator. Make sure that the food is well cooled when it is bought and also when transporting it. Use insulated cooling bags.
- When taking food out of the refrigerator only open the refrigerator door very briefly.
- Foods must be packed - best of all in closed containers - and stored separately from each other.
- Allow foods that have been warmed up to cool down before storing.
- Store quickly perishable foods directly next to the cooling fins.
- The refrigerator must not be exposed to direct sunlight. Please bear in mind that the temperature inside a closed vehicle increases sharply if exposed to sunlight and that this can reduce the efficiency of the refrigerator.
- The air inside the refrigerator unit **MUST** be able to circulate freely without any hindrance. (see also Section 6.3 "Ventilation and air extraction" in the Operating Manual)
- Products that could emit volatile, flammable gases must not be stored in the refrigerator.

The freezer compartment is suitable for making ice cubes and for short-term storage of frozen food. It is not suitable as a means of freezing foods.

5.4

Making ice cubes

Ice cubes are best frozen overnight. At night, the refrigerator has less work to do and the unit has more reserves.



1. Fill the ice cube tray with drinking water.

2. Place the ice cube tray in the freezer compartment.



Only use drinking water!

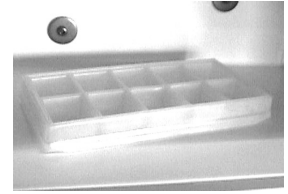

5.5

Defrosting

As time goes by, frost builds up on the fins.

When the layer of frost is about 3mm thick, the refrigerator should be defrosted.

1. Switch off the refrigerator, as described in Section 5.8 - "Switching off".
2. Remove the ice cube tray and food.
3. Leave the refrigerator door open.
4. After defrosting (freezer compartment and fins free of frost), wipe the cabinet dry with a cloth.
5. Use a cloth to mop up the water from the freezer compartment.
6. Switch the refrigerator back on again.

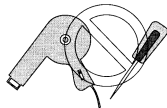

The layer of ice must never be removed forcibly, nor may defrosting be accelerated using a heat source.

Note:

Water thawing in the main compartment of the refrigerator runs into an appropriate container at the back of the refrigerator. From there, the water evaporates.

5.6

Positioning the storage rack

Dismantling:

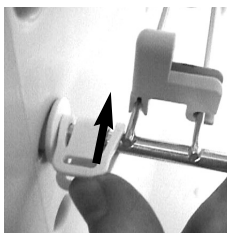

1. Loosen the front and back securing brackets.

2. Move the storage rack to the left and remove it.

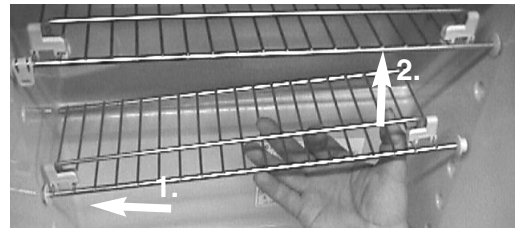

To fit the storage rack, the reverse order applies.

5.7

Door locking

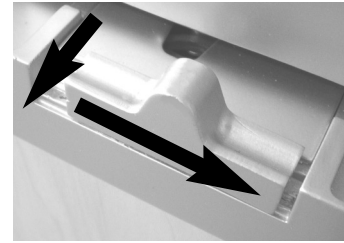
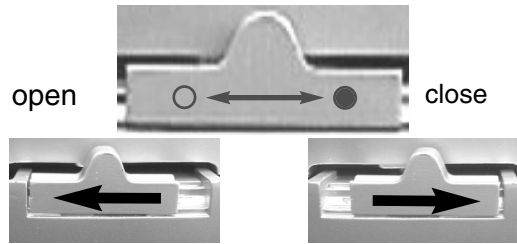

park-position / vent-position

5.8

Switching off

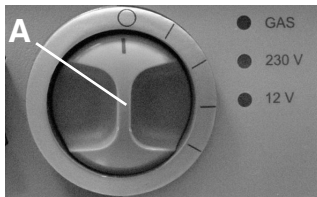

1. Set energy selector switch (A) to position "0" (OFF). The appliance is now fully switched off.

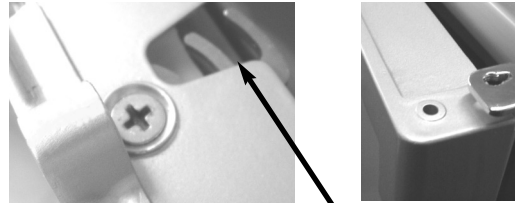

2. Secure the door open by means of the door stop. The door will be slightly ajar. This is to prevent mould from forming inside the appliance.



Switching off gas operation

If the refrigerator is to be taken out of service for an extended period of time, the on-board shut-off valve and the cylinder valve must be closed.

5.9

Winter operation

1. Check that the ventilation grilles and the extractor have not been blocked by snow, leaves or similar.

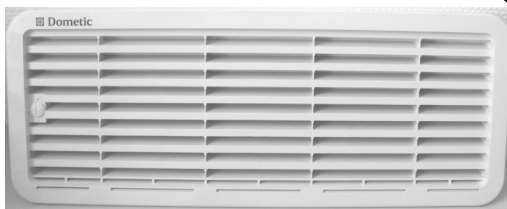

Lower ventilation grille (L200)

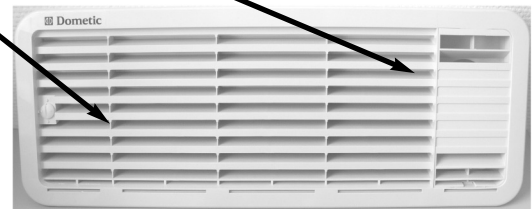

Upper ventilation grille with flue vent (L100)

2. When the ambient temperature falls below **46°F**, the *optional* winter covers should be fitted. This protects the unit from excessively cold air.

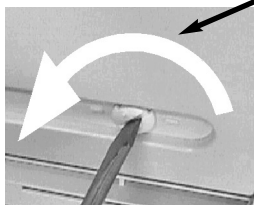

3. Affix the cover and fasten it.

Option (ask your dealer)



TIP

You should also attach the winter cover if the vehicle is taken out of service for a longer period or while it is being cleaned from the outside.

5.10

Interior light

Changing the light bulbs

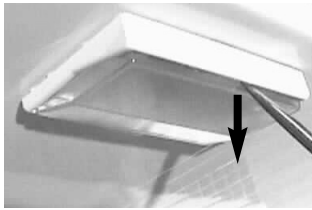

1. Remove cover.

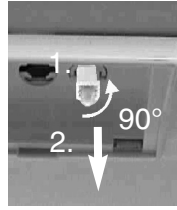

2. Detach defective light bulb.

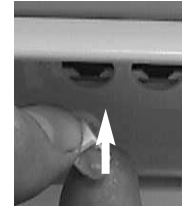

3. Fit new light bulb

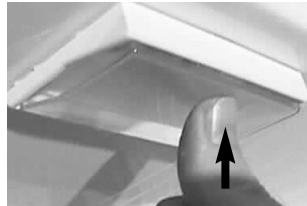

4. Clip the cover back in place.

Note:

For 12V DC :

1 light bulb 12V, 2W

Please contact Dometic Service Centres for replacement light bulbs.

5.11

Changing the decor panel

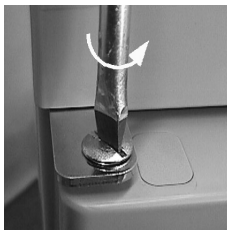

1. Open the door and loosen the hinge screw.



2. Take off the door by moving it upwards.

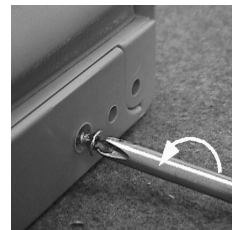

3. Unscrew the door strip (3 screws).

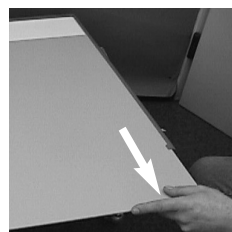

4. Remove the decor plate and insert a new decor plate.

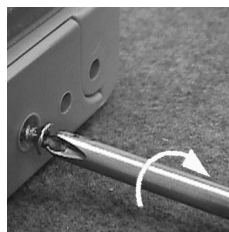

5. Screw the door strip back in position.

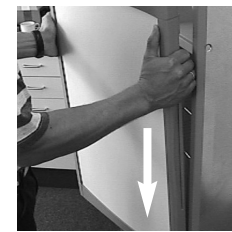

6. Put the door back on.

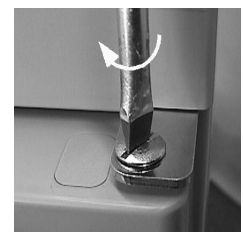

7. Tighten the hinge screw.

Dimensions of the panels in mm:

Model	Height	Width	Thickness
RM 7271 /..75	730+1	453,5+1	3,2
RM 7361 /..65	730+1	453,5+1	3,2
RM 7371	713+/-1	453,5+1	3,2
RM 7291 /..95	730+1	491,5+1	3,2
RM 7401 /..05	730+1	491,5+1	3,2

5.12

Changing the doorhang

i It is not always possible to change the door when the refrigerator is installed.



1. Open the door, unscrew the hinge screw and keep it to hand.



2. Take off the door by moving it upwards.

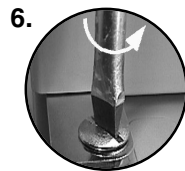

6.

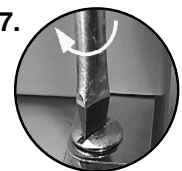

7.

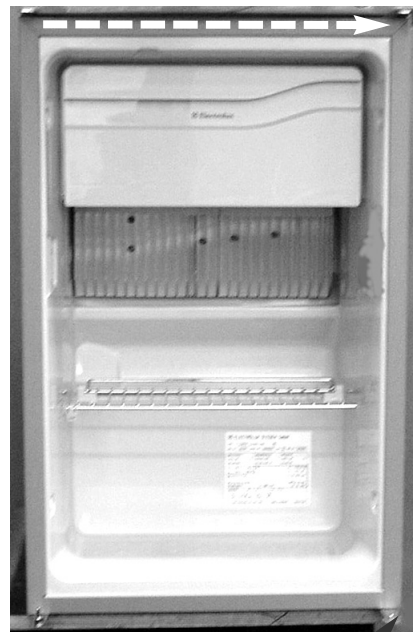

5. Attach the door.



3.

4.



8. Screw the hinge screw back in.

5.13

Troubleshooting

Before calling the authorised Service Department, please check whether:

1. The instructions in the section "Using the refrigerator" have been followed.

2. The refrigerator is not tilted excessively.

3. It is possible to operate the refrigerator with an available power source.

Failure : The refrigerator does not work in gas operation mode.

Possible cause	Action you can take
a.) Gas bottle empty.	a.) Change gas bottle.
b.) Is the supply cut-out device open?	b.) Open the cut-out device.
c.) Air in the gas pipe?	c.) Switch device off and on again 3-4 times to remove air from the gas pipe.

Failure : The refrigerator does not work on 12V.

Possible cause	Action you can take
a.) On-board fuse defective.	a.) Fit new fuse.
b.) On-board battery discharged.	b.) Check battery, charge it
c.) Engine not running.	c.) Start engine.

Failure : The refrigerator does not work on 230V.

Possible cause	Action you can take
a.) On-board fuse defective.	a.) Fit new fuse.
b.) No connection to supply voltage.	b.) Establish power connection.
c.) AES : gas operation despite connection to the supply voltage?	c.) Appliance switches to gas operation due to insufficient supply voltage (automatically switches back to 230 V operation)

Failure : The refrigerator does not cool sufficiently.

Possible cause	Action you can take
a.) Inadequate ventilation to the unit.	a.) Check that the ventilation grilles are not covered.
b.) The thermostat setting is too low.	b.) Turn the thermostat to a higher setting.
c.) There is too much ice on the condenser.	c.) Check that the refrigerator door seals when shut.
d.) Too much warm food put inside.	d.) Let food cool down first.
e.) Appliance running for a short time.	e.) Wait several hours, check again.

5.14

Maintenance

- **Works on gas components and electrical installation may only be carried out by authorised personnel.** We recommend to contact your Dometic Service Centre.
- The appliance's gas equipment and its associated fume system must be inspected after installation.
Afterwards an authorised technician must inspect every two years.
It is the user's responsibility to arrange for inspections after purchase.
- It is recommended that the gas burner be inspected and cleaned as necessary at least once a year.

TIP We recommend maintenance following an extended shutdown of the vehicle.

5.15

Product liability

Product liability of Dometic GmbH does not include damages which may arise from faulty operation, improper alterations or intervention in the equipment, adverse effects from the environment such as changes in temperature and air humidity, which may impact the equipment itself or the direct vicinity of the equipment or persons in the area.

5.16

♣ Environmental hints

Refrigerators manufactured by Dometic GmbH are free of CFC/HCFC and HFC. Ammonia (a natural compound of hydrogen and nitrogen) is used in the cooling unit as a coolant. The non-ozone-hazardous cyclopentan is used as a propellant in the manufacture of the PU foam insulation.

5.17

♣ Disposal

In order to ensure that the recyclable packaging materials are re-used, these should be sent to the usual local collection system.

The appliance should be transferred to a suitable waste disposal company that will ensure re-use of the recyclable components and proper disposal of the rest.

For eco-friendly draining of the coolant from all absorber refrigeration units, a suitable disposal plant should be used.

5.18

♣ Energy-saving tips

- At an average ambient temperature of approx. 25°C, it is sufficient to operate the refrigerator at the middle thermostat setting (for both gas and mains voltage).
- Where possible, always store goods that have previously been cooled.
- Do not position the refrigerator in direct sunlight.
- Constant circulation of air must be supplied to the refrigerator unit.
- Defrost regularly.
- Open the door only for a short time when removing goods from the refrigerator.
- Run the refrigerator for about 12 hours before filling it.

5.19

Technical data

Model	Dimensions H x W x D (mm) depth incl. door	Gross capacity incl. freezer compartment	Usable capacity of freezer compartment	Connection Mains / Battery	* Consumption electricity / gas in 24 hrs	Netweight	Ignition Flame Failure Device	Stepped- cabinet
RM 7271(L)	821x486x541	77 lit.	9.5 lit.	125 W / 120 W	ca. 9.00 MJ/h / 260 g	26 kg	X	X
RM 7275(L)	821x486x541	77 lit.	9.5 lit.	125 W / 120 W	ca. 9.00 MJ/h / 260 g	26 kg	X	X
RM 7291(L)	821x525x541	86 lit.	10.5 lit.	125 W / 120 W	ca. 9.36 MJ/h / 260 g	27 kg	X	X
RM 7295(L)	821x525x541	86 lit.	10.5 lit.	125 W / 120 W	ca. 9.36 MJ/h / 260 g	27 kg	X	X
RM 7361(L)	821x486x541	88 lit.	9.5 lit.	135 W / 130 W	ca. 9.36 MJ/h / 260 g	28 kg	X	
RM 7365(L)	821x486x541	88 lit.	9.5 lit.	135 W / 130 W	ca. 9.36 MJ/h / 260 g	28 kg	X	
RM 7371(L)	821x486x606	89 lit.	11.0 lit.	125 W / 130 W	ca. 9.00 MJ/h / 270 g	27 kg	X	X
RM 7401(L)	821x525x541	97 lit.	10.5 lit.	135 W / 130 W	ca. 9.36 MJ/h / 260 g	29 kg	X	
RM 7405(L)	821x525x541	97 lit.	10.5 lit.	135 W / 130 W	ca. 9.36 MJ/h / 260 g	29 kg	X	

We reserve the right to make technical changes.

*Average consumption measured at an average ambient temperature of 25°C in pursuance of ISO Standard.

5.20

Connecting points

Dimensions to the connection points (mm):

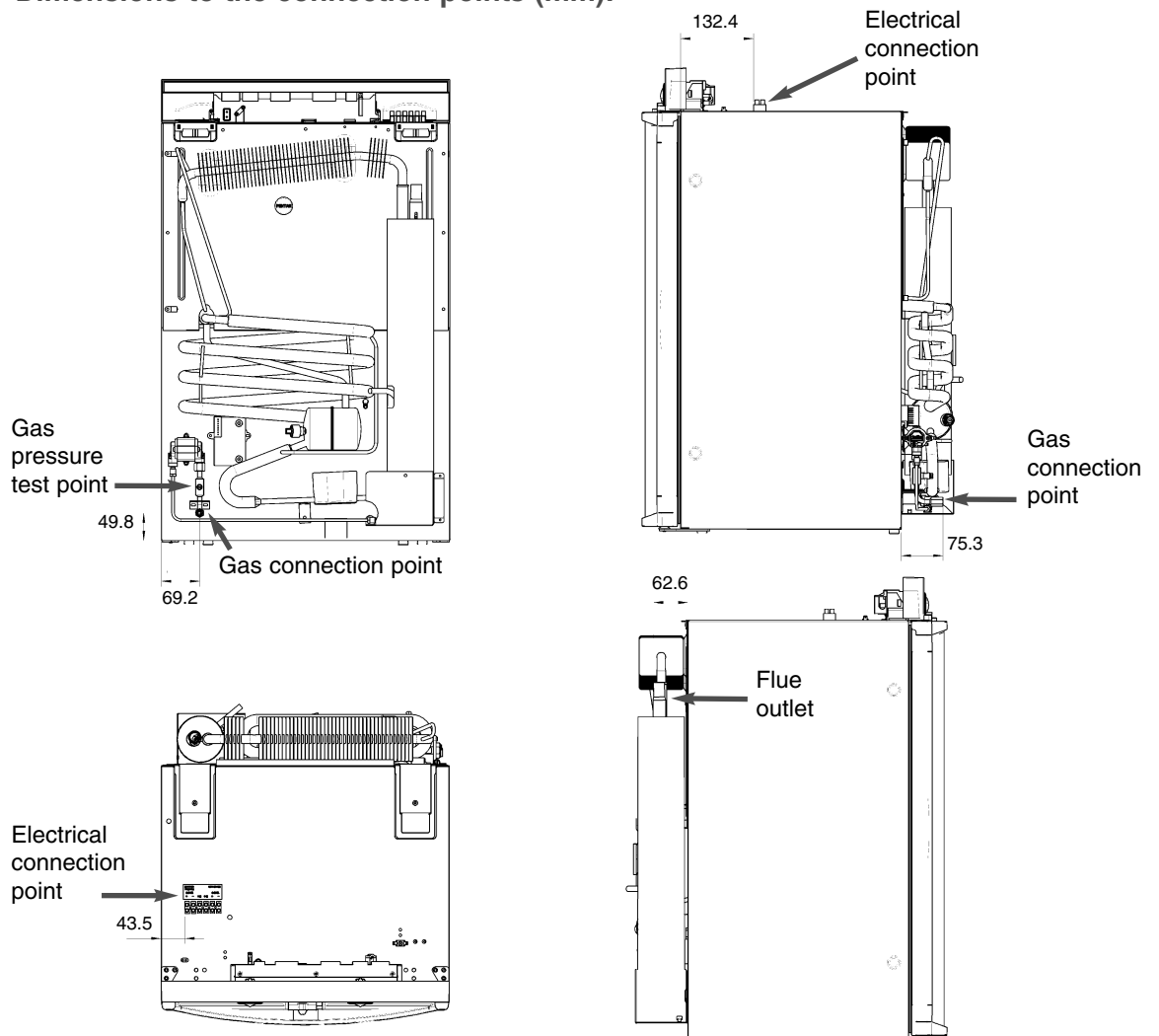

6.0

INSTALLATION GUIDE

On installation of the appliance, the technical and administrative regulations of the country in which the vehicle will first be used must be adhered to. Otherwise the refrigerator must be installed as described in these instructions. In some OEM applications it may not be possible for these instructions to be followed exactly. In this case an authorised Dometic representative may issue supplementary instruction.

6.1

Installation

The appliance and its fume extraction shall be installed in such a way as to be accessible for servicing at all times and must be capable of easy removal and installation.

The appliance may only be installed by authorised personnel.

Installation and connection of the appliance must comply with the latest technical regulations.

It must be installed in accordance with

- the manufacturer's installation instructions,
- local gas fitting regulations,
- municipal building codes,
- electrical wiring regulations,
- AS 5601- Gas Installations

and any other statutory regulations.

The appliance shall be installed in such a way that it is shielded from excessive heat radiation.

Excessive heat impairs performance and raises the energy consumption of the refrigerator.

 **Any installation that is not carried out by authorised persons will jeopardize the manufacturer's guarantee.**

6.1.1

Side installation

If the appliance is installed on the same side of the vehicle as the entrance door, it is desirable that the door does not cover the refrigerator's vents.

If this cannot be avoided there must be a gap of at least 25mm between the door and the vents.

6.1.2

Rear installation

If the refrigerator is mounted at the rear of the vehicle you must ensure the lower grille is not covered by the bumper or rear lights.

This would prevent the air from circulating properly and cause problems in warm weather.

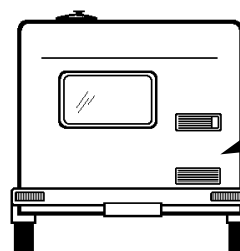
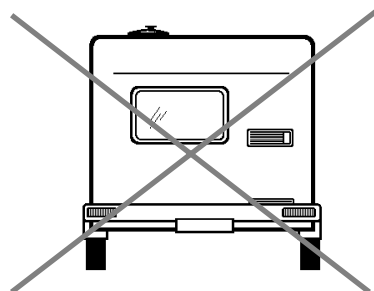

Air vent grille not blocked: OK!

6.2

Draught-free installation

The refrigerator shall be sealed so that fumes cannot enter the living area. Illustrated below are two typical approved methods of sealing.

Do NOT use any easily inflammable materials (in particular silicone sealing agent or similar) for sealing! The device manufacturer's product liability and guarantee shall lapse if such materials are used.

Proposal 1:

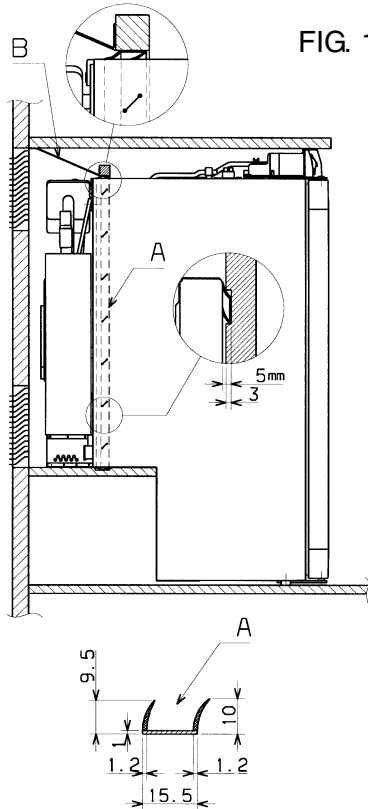

FIG. 1

Using the Installation Sealing Kit from Dometic (SP.No. 241 2559-00, available from Dometic)

Insert lipped seals (A) into the installation recesses at the bottom and at each side.

Insert deflector plate (B), fitted with a lipped seal (A) of heavy-duty, non-flammable material, into the installation recess (see Fig. 4).

Insert deflector plate (B) in such a way that the hot air escapes through the air vent grille into the open air.

Affix the discharge plate to the caravan wall, **not to the refrigerator!**

In addition, discharge plate (B) with its lipped seal (A) must seal the refrigerator off from the living area (see FIG. 1).

Ensure that the refrigerator is installed level in the recess.

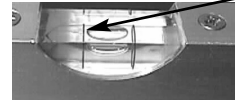

Proposal 2:

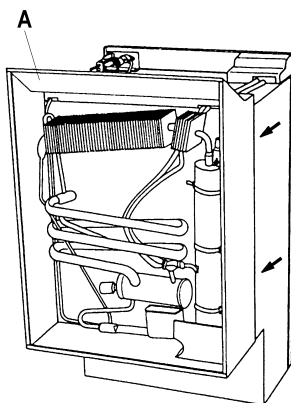

Another option is to provide the refrigerator with a cowl (A). The cowl (A) should ideally be affixed to the caravan wall, **not to the refrigerator**. Insert sealing strips at the bottom and sides of the cover.

Finally, push the refrigerator into the cover from the front.

i Both of these installation options facilitate the removal and installation of the appliance for servicing.

Comment:

Other methods of sealing may be approved. However the chosen method must prevent draughts entering the living space of the motorhome. Failure to seal correctly will allow

warm air to collect around the refrigerator and its performance will be affected. If the cavity between the caravan wall and the refrigerator is sealed so that fumes cannot penetrate the living area it is possible to vent the flue gas directly through the upper grille without using the aluminium flue pipe. For this installation method, it is recommended that the same air vent grille should be used at the top and at the bottom (**L200**), and that the T-piece of the flue pipe is turned 45 degrees.

⚠ In this case, for gas operation, do not use the upper winter covering!

If even with draught-free installation a fume chimney is desirable, you must incorporate the L100 ventilation and extraction system into the upper air vent opening.
Installation of fume chimney: please refer to point "6.7".

⚠ Deviations shall require the consent of the manufacturer.

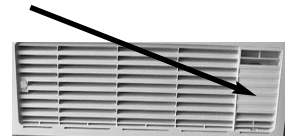

6.3

Ventilation and extraction

A correct installation is important for correct operation of the appliance to ensure, there is no build-up of heat at the back of the appliance. This heat must be allowed to escape into the open air.

In the event of high ambient temperatures, full performance of the cooling unit can only be achieved by means of adequate ventilation and extraction.

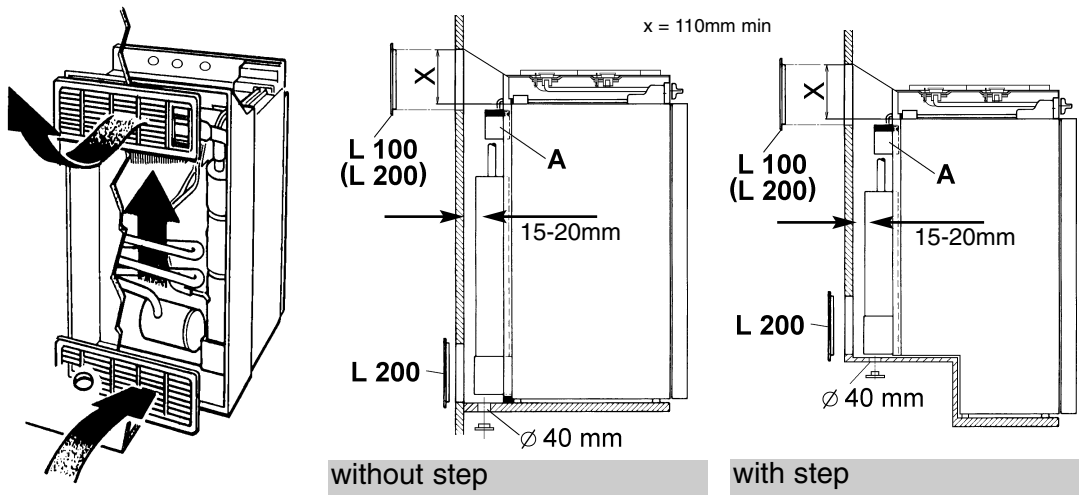

Ventilation is provided for the unit by means of two apertures in the caravan wall. Fresh air enters at the bottom, extracts the heat and exits through the upper vent grille.

The **upper** ventilation grille should be positioned as high as possible above the condenser (A) .

The **lower** ventilation grille should be **flush with the floor of the vehicle**, allowing any gas leakages (heavier than air) to escape directly into the open air.

If such an arrangement is not possible a hole must be provided by the manufacturer of the vehicle under the refrigerator (not close to the burner) so that any leaking LP gas can escape. This must have an effective area of at least 13cm². It is desirable to fit the hole with wire mesh or similar, and an angle plate to protect it from stones, mud etc., the wire mesh must not reduce the effective area of 13cm².

The ventilation grilles must have an open cross-section of at least 250cm². This is reached using the Dometic Absorber Ventilation and Air Extraction System L100 / L 200 that has been tested and approved for this purpose.

Comment:

If the distance between the wall and the refrigerator is greater than 20mm the gap can be reduced to 20mm by fitting a suitable baffle piece.

i **Correct mounting of the lower ventilation grille facilitates the access to the electrical and gas connections during maintenance work.**

6.4

Installing the ventilation system

L 100

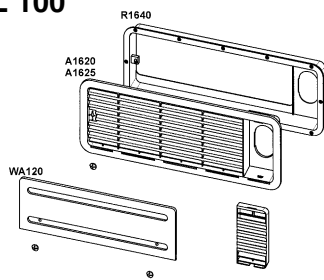

L 200

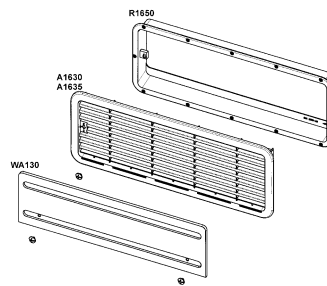

To install the ventilation grilles, cut two rectangles (451mm x 156mm) in the outer wall of the vehicle (for position of the cuts, see point "6.3").



Item 1 does not apply for installation frames with an integrated seal.

1. Seal the mounting frame, making it waterproof.



2. Insert the frame ...

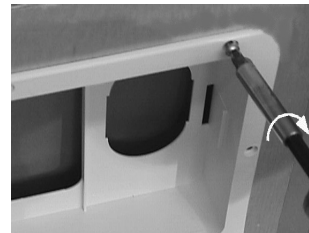

... and screw into position.



3. Insert the ventilation grilles.



4. Lock the ventilation grilles.



5. Clip the extractor insert in position
(only for upper ventilation system L100)



6. Insert winter cover (optional)

6.5

Installation recess

The refrigerator must be installed draught-free in a recess (see point “6.2”).

The measurements of the recess are given in the table below.

Step (A) is only required for cabinets with a step. Push the appliance far enough into the recess until the front edge of the refrigerator casing is flush with the front of the recess. Allow a gap of 15-20 mm between the back wall of the recess and the refrigeration unit. The floor of the recess must be level, allowing the appliance to be pushed easily into its correct position. The floor must be substantial enough to bear the weight of the appliance.

Ensure that the refrigerator is installed level in the recess.

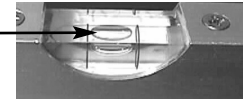

Recess measurements:

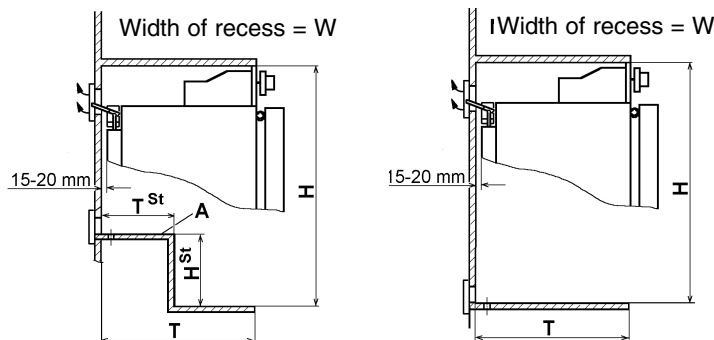

Model	Height H	Width W	Depth T	Height HSt	Depth TS
RM 7271	825 mm	490 mm	515 mm	220 mm	235 mm
RM 7275	825 mm	490 mm	515 mm	220 mm	235 mm
RM 7291	825 mm	529 mm	515 mm	220 mm	235 mm
RM 7295	825 mm	529 mm	515 mm	220 mm	235 mm
RM 7361	825 mm	490 mm	515 mm	-	-
RM 7365	825 mm	490 mm	515 mm	-	-
RM 7371	825 mm	490 mm	580 mm	220 mm	235 mm
RM 7401	825 mm	529 mm	515 mm	-	-
RM 7405	825 mm	529 mm	515 mm	-	-

6.6

Securing the refrigerator

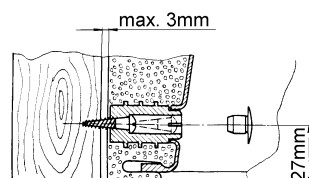
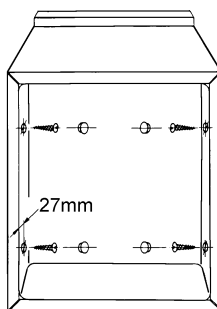

In the sidewalls of the refrigerator, there are four plastic sleeves with screws for securing the refrigerator. The sidewalls or rails attached for securing the refrigerator must be designed in such a way that the screws will remain firmly in place even when under increased load (while the vehicle is moving).

Always insert screws through the sleeves provided; otherwise, structural parts embedded in the foam, such as cables, etc., may be damaged.

Once the refrigerator is in its final position, secure the screws into the wall of the recess.

The screws must penetrate through the sheet metal casing of the refrigerator.

6.7

Fume extraction

Fume extraction must be arranged in such a way as to provide complete extraction of all products of combustion to an area outside the living area. The flue system must slope in an upward direction in order to avoid a build-up of condensation.

△ An installation that is not carried out by qualified persons causes a reduction in the cooling capacity and will jeopardize the manufacturer's guarantee.

6.7.1

Fitting the fume flue in the upper ventilation grille

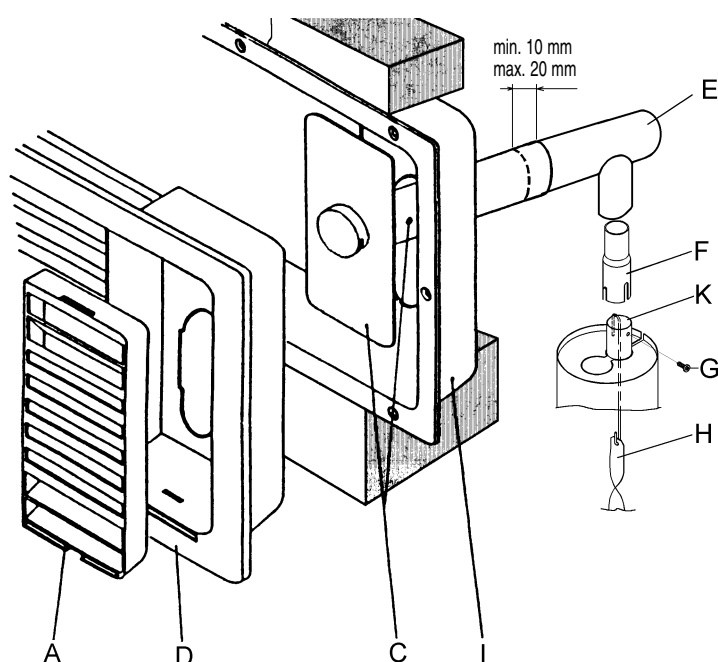

1. Connect T-piece (E) to adaptor (F) or tail pipe (K) as required and affix with screw (G). Ensure that heat baffle (H) is lodged in the correct position.
2. Insert flue pipe with cover plate (C) through the appropriate aperture in frame (I) and connect to T-piece (E). If necessary, shorten flue pipe (C) to the required length.
3. Insert ventilation grille (D) into mounting frame (I) and fasten, using the locking handle on the left of the grille.
4. Insert extractor insert (A) into ventilation grille (D).

6.8

Gas installation

- The rules in point 6.1 must be adhered to.
- When running on gas, these appliances are intended exclusively to use liquid gas (propane) - under no circumstances should town gas or natural gas be used.
- An AGA Approved LP Regulator must be fitted to the gas supply.
- The pressure regulator must concur with the operating pressure specified on the data plate of the appliance. The operating pressure corresponds to the standard pressure of the country of specification.
- Only one connection pressure is permissible for any one vehicle. A plate showing the permanent, clearly legible notice must be displayed in full view at the point where the gas cylinder is installed.
- This appliance is not suitable for connection with a Flexible Hose.
- Inflammable material should not be in immediate proximity to the burner.
- The gas connection to the appliance is 1/8" BSP Female.

⚠ The gas connection may only be carried out by authorized personnel.

Before Leaving - Check all connections for gas leaks with soap and water. DO NOT use a naked flame for detecting leaks. Ignite the burner to ensure correct operation of gas valve, burner and ignition. When satisfied with the appliance, please instruct the user on the correct method of operation. In case the appliance fails to operate correctly after all checks have been carried out, refer to the authorised service provider in your area.

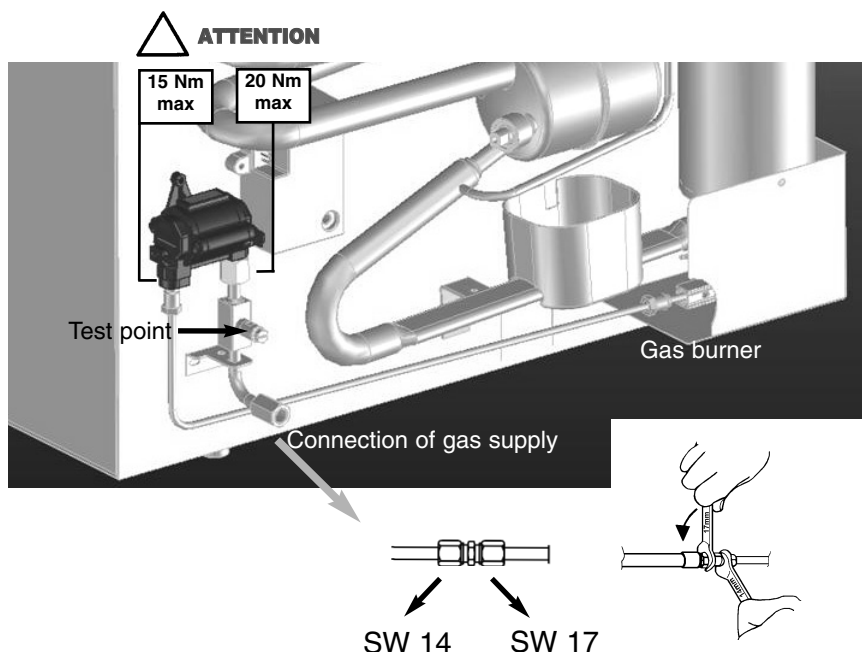

i The refrigerator must be equipped with a gas cock in the supply line to allow the supply to be disconnected. Such a cut-out device must be readily accessible to the user.

Gas pressure

Refer to data label for test point pressure.

6.9

Electrical installation

- ⚠ Electrical installation may only be carried out by qualified personnel. The connection cables must be laid in such a way that they do not come in contact with hot components of the unit/burner or with sharp edges. The electrical installation must comply with national regulations.

It is advisable to run the incoming supply through an on-board fuse or automatic circuit breaker. The power cable must be laid in such a way that it does not come in contact with hot components of the unit/burner or with sharp edges.

- ⚠ Changes at the internal electrical installation or the connection of other electrical components (e.g. external fan) to the internal wiring of the appliance will expire any claims from guarantee and product liability!

6.9.1

Power line connection

- ⚠ The power must be supplied via a properly earthed socket outlet or hard-wired connection. Where a socket outlet is used for the mains connection lead, the outlet must be freely accessible.

It is advisable to run the incoming supply through an on-board fuse or automatic circuit breaker.

The power cable must be laid in such a way that it does not come in contact with hot components of the unit/burner or with sharp edges.

- ⚠ If the connection cable is damaged it must be replaced by the Customer Service at Dometic, or by respectively qualified personnel, in order to prevent any hazards.

6.9.2

Battery connection

The machine's mains 12V connection cable is connected (observing correct polarity) to a terminal strip. The cabling must be direct and by the shortest possible route to the battery and alternator respectively.

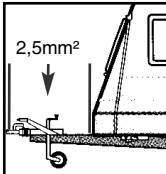
	Cross-sectional area of cable	Length of cable	
Motorcaravan	4 mm ²	< 6 m	
Caravan (inside)	6 mm ²	> 6 m	
Caravan (outside)	min 2,5 mm ²	(EN1648-1)	

The 12V circuit must be protected with a 16A fuse.

The heating element circuit must be connected to the vehicle battery by a suitable ignition operated relay in order that the 12V supply is only live while the vehicle ignition is switched on. The connection **C/D** (interior light, electronics ; cable black / violet) must be **permanently attached**, and must not be cut-out when the vehicle ignition key is turned off. This can be realised with an on-board habitation battery i.e. **This 12V permanently connection must be protected with a 2A fuse!**

- ⚠ If the appliance is installed in a caravan the respective leads for 12V+ and 12V- the connections **A/B** and **C/D** must not be connected to each other on the caravan-side)

6.9.3

D+ connection and Solar Control connection (AES only)

D+ connection

The D+ control connection must be connected to the respective vehicle terminal (alternator signal while motor is running).

Solar control input (S+):



Connection only when using a solar system with a solar charging controller with AES output.

The respective solar charging controllers are available from a specialized dealer.

The “Solar” (S+) control connection must be connected to the respective terminal of the solar charging controller (AES output).

Cable cross-sections

There are no particularly high current flows via the D+ and S+ connection; therefore no particularly large cross-section is required for these connections (approx. 1mm²).

6.9.4

Terminal strip (RM 7XX1 L and RM 7XX5 L models)

Connections:

A = Ground heating element DC

B = Plus heating element DC

C = Ground electronics

D = Plus electronics

D+ = alternator signal

S+ = AES-input-control signal
(solar charge regulator)

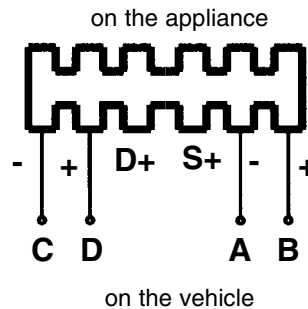

6.9.5

Retrofitting



For all RM 7xx1 *MES* appliances there is an additional possibility for retrofitting to an RM 7xx5 device with AES functions. Please consult your nearest Dometic Customer Service or your specialist dealer.

6.9.6

Wiring diagram

Wiring diagram for RM 7XX1 L - models and RM 7XX5 L - models

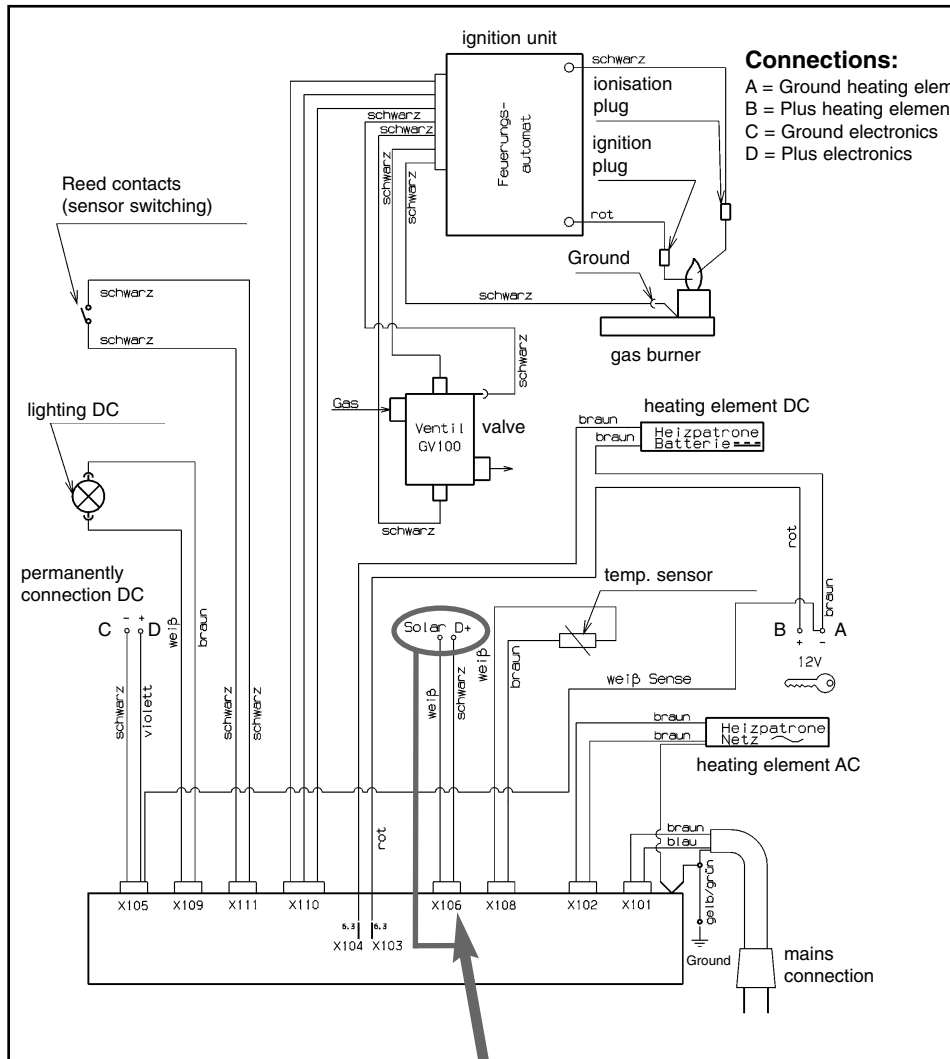

For the RM 7XX1 L models, there is no X106 connection (Solar S+ and D+)!

Connections:

- A = Ground heating element DC
- B = Plus heating element DC
- C = Ground electronics
- D = Plus electronics

Colours:

- schwarz = black
- violett = violet
- braun = brown
- weiss = white
- grün = green
- gelb = yellow
- rot = red



For operation, it is compulsory to provide the device with a permanent 12V DC connection at terminals C/D (permanent voltage supply for the functional electronics).



Dometic GmbH
In der Steinwiese 16
D-57074 Siegen
GERMANY

www.dometic.com