

# **Function Generator**

**Model : GFG-3015**

**Operation Manual**

82FG-30150MB

<b>Table of Contents</b>	<b>Page</b>
1. Precautions.....	2
2. Product Introduction.....	5
3. Features .....	6
4. Specifications .....	7
5. Front and Rear Panels .....	10
6. Operation .....	18
6.1 The First Step Setup For Instrument .....	18
6.2 The Setup of Output Function.....	18
6.3 The Setup of Frequency.....	18
6.4 The Setup of Amplitude .....	19
6.5 The Setup of Offset .....	19
6.6 The Setup of Duty.....	20
6.7 The Setting of STORE .....	20
6.8 The Setting of RECALL .....	20
6.9 The SHIFT Key and Function Keys .....	21
6.10 Setup of LIN or LOG Sweep.....	21
6.11 Setup of AM Modulation .....	25
6.12 Setup of FM Modulation.....	26
6.13 Setup of Trigger.....	28
6.14 Setup of GATE and BURST .....	30
6.15 Setup of External Counter .....	32
6.16 THE VCF Function.....	34
6.17 THE GCV Output Function.....	35
6.18 THE TTL Signal Output Function .....	36
6.19 THE SYNC Signal Output Function.....	36
6.20 Remote Control - RS232 Interface .....	36
6.21 Commands Syntax .....	38
6.22 The Commands of RS-232 Serial Interface .....	41
6.23 The Examples of the Communication Interface Software .....	44
6.24 The Error message of instrument.....	47
7. Adjustment and Correction .....	48
7.1 Preparation.....	48
7.2 Adjust and Check up the operation DC Voltage.....	48
7.3 Adjusting Main Clock.....	49
7.4 Adjusting Sensitivity of counter .....	49
7.5 Adjusting VCF Function 100:1 .....	49
7.6 Adjusting Main Frequency , Duty Cycle and GCV Output Check .....	49
7.7 Adjusting Rise/Fall Time.....	50
7.8 Adjusting Main Sine wave Harmonic Distortion.....	50
7.9 Adjusting Modulation source .....	50
7.9.1 Adjusting Rate and symmetry.....	50
7.9.2 Adjusting Sine wave Harmonic Distortion .....	51
7.10 Adjusting AM modulation .....	51
7.11 Adjusting FM and Sweep Function.....	53
7.12 Adjusting Trigger Phase.....	55
7.13 Calibrating by Software .....	56
8. The Block Diagram and Description of the System .....	62

## EC Declaration of Conformity

We

**GOOD WILL INSTRUMENT CO., LTD.**

No. 7-1, Jhongsing Rd, Tucheng City, Taipei County 236, Taiwan

**GOOD WILL INSTRUMENT (SUZHOU) CO., LTD.**

No. 69, Lushan Road, Suzhou New District Jiangsu, China

declares that the below mentioned product

**GFG-3015**

is herewith confirmed to comply with the requirements set out in the Council Directive on the Approximation of the Law of Member States relating to Electromagnetic Compatibility (89/336/EEC, 92/31/EEC, 93/68/EEC) and Low Voltage Equipment Directive (73/23/EEC, 93/68/EEC). For the evaluation regarding the Electromagnetic Compatibility and Low Voltage Equipment Directive, the following standards were applied:

⊙ **EMC**

<b>EN 61326-1: Electrical equipment for measurement, control and laboratory use — EMC requirements (1997+A1: 1998+A2: 2001)</b>	
Conducted and Radiated Emissions EN 55011: 1998 class A	Electrostatic Discharge EN 61000-4-2: 1995+A1:1998
Current Harmonic EN 61000-3-2: 2000	Radiated Immunity EN 61000-4-3: 1996+A1:1998
Voltage Fluctuation EN 61000-3-3: 1995	Electrical Fast Transients EN 61000-4-4: 1995
-----	Surge Immunity EN 61000-4-5: 1995
-----	Conducted Susceptibility EN 61000-4-6: 1996
-----	Power Frequency Magnetic Field EN 61000-4-8 : 1993
-----	Voltage Dips/ Interrupts EN 61000-4-11: 1994

⊙ **Safety**

<b>Low Voltage Equipment Directive 73/23/EEC &amp; amended by 93/68/EEC</b>
Safety Requirements IEC/EN 61010-1: 2001



# 1. Precautions

GFG-3015 is specially designed for safety operation. It has passed through rigorous tests of inclement environment to ensure its reliability and good condition.

The following precautions are recommended to insure your safety and keep the best condition of the equipment.





## (1) Safety Terms and Symbols

The following terms and symbols may appear in this manual:

	<b>WARNING</b>	This statement identifies conditions or practices that could result in injury or loss of life.
	<b>CAUTION</b>	This statement identifies conditions or practices that could result in damage to this product or other properties.

The following terms and symbols may appear on the product:

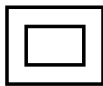
<b>DANGER</b>	This term indicates an immediately accessible injury hazard.
<b>WARNING</b>	This term indicates that an injury hazard may occur, but is not immediately accessible.
<b>CAUTION</b>	This term indicates potential damage to this product or other properties.

					
<b>DANGER</b> High voltage	Protective Conductor Terminal	<b>ATTENTION</b> refer to manual	Double Insulated	<b>DANGER</b> Hot surface	Earth Ground Terminal

**(2) Do not place any heavy objects on the instrument under any circumstances.**

## (3) Disassembling the instrument

Due to the precision of this instrument, all the procedures of disassembling, adjusting, and maintenance should be performed by a professional technician. If the instrument has to be opened or adjusted under some unavoidable conditions, and to be managed by a technician who is familiar with GFG-3015. Once there is any abnormality, please contact our company or our distributor near you.

## (4) Power Supply

AC input should be within the range of line voltage  $\pm 15\%$ , 50/60Hz. To prevent the instrument from burning up, be sure to check the line voltage before turning on power.

## (5) Grounding



**WARNING**

To avoid electrical shock, the power cord protective grounding conductor must be connected to ground.

GFG-3015 can be operated only with an earth grounded AC power cord that connects the case and ground well. This is to protect the user and the instrument from the risk of shock hazard.

## (6) Fuse Replacement



**WARNING**

For continued fire protection, replace fuse only with the specific type and rating by qualified personnel. Disconnect the power cord before replacing fuse.

The fuse blows only when there is any wrong on the instrument, which will stop working under this situation. Please find out the cause, then open the outside case **(Please see the Figure (A), Figure (B) on below)** and replace a proper fuse as listed below. Be sure to use the correct fuse before changing the applying location.

**F101** : T 0.8A/250V  
**F100** : T 0.5A/250V

Check the line voltage setting on the rear panel. If the line voltage setting does not match, Please change the line voltage setting according to the following steps:

1. Remove line cord from AC socket.
2. Switch the "AC line voltage switch" to correct setting with flat-blade screwdriver and reinsert.

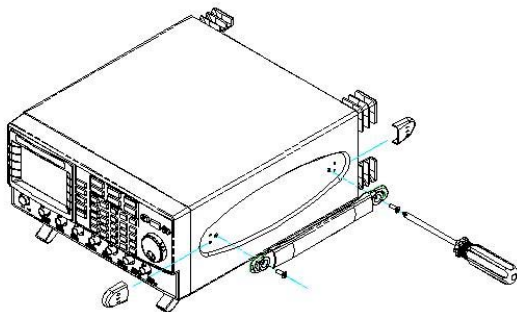

**Figure (A)**

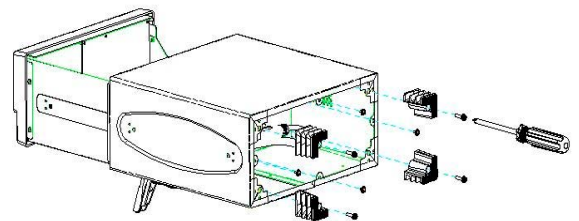

**Figure (B)**

## (7) Cleaning the Cabinet

Disconnect the AC power cord before cleaning the instrument.

Use a soft cloth dampened in a solution of mild detergent and water. Do not spray cleaner directly onto the instrument, since it may leak into the cabinet and cause damage.

Do not use chemicals containing benzene, benzene, toluene, xylene, acetone, or similar solvents.

## (8) Operation environment

Indoor use	
Altitude up to 2000m	
Temperature to satisfy the specification :	18°C ~ 28°C (+64.4°F ~ +82.4°F)
Operating temperature :	0°C ~ 40°C (+32°F ~ +104°F)
Storage temperature :	-10°C ~ 70°C (+14°F ~ 158°F)
Relative humidity :	up to 90% when 0°C~35°C; up to 70% when 35°C~40°C
Installation category :	CAT II (The detail is as Table A)
Pollution degree :	2

Table A

CAT IV	For measurements performed at the source of the low-voltage installation.
CAT III	For measurements performed in the building installation.
CAT II	For measurements performed on circuits directly connected to the low-voltage installation.
CAT I	For measurements performed on circuits not directly connected to Mains.

**(9) Place GFG-3015 in a location with a suitable environment as stated above free from dust, direct exposition of sunlight, and strong effect of magnetic fields.**

## (10) For United Kingdom

### NOTE

This lead/appliance must only be wired by competent persons.

### WARNING

THIS APPLIANCE MUST BE EARTHED

### IMPORTANT

The wires in this lead are coloured in accordance with the following codes:

Green/Yellow :Earth  
Blue :Neutral  
Brown :Live  
(Phase)

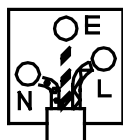

As the colours of the wires in mains leads may not correspond with the coloured markings identified in your plug/appliance, proceed as follows:

The wire which is coloured Green and Yellow must be connected to the Earth terminal marked with the letter E or by the earth symbol  $\oplus$  or coloured Green or Green and Yellow.

The wire which is coloured Blue must be connected to the terminal which is marked with the letter N or coloured Blue or Black.

The wire which is coloured Brown must be connected to the terminal marked with the letter L or P or coloured Brown or Red.

If in doubt, consult the instructions provided with the equipment or contact the supplier.

This cable/appliance should be protected by a suitably rated and approved HBC mains fuse; refer to the rating information on the equipment and/or user instructions for details. As a guide, cable of 0.75mm<sup>2</sup> should be protected by a 3A or 5A fuse. Larger conductors would normally require 13A types, depending on the connection method used.

Any moulded mains connector that requires removal/replacement must be destroyed by removal of any fuse and fuse carrier and disposed of immediately, as a plug with bared wires is hazardous if engaged in a live socket. Any re-wiring must be carried out in accordance with the information detailed in this section.

## 2. Product Introduction

The frequency feedback method applied by GFG-3015 is a new technique that generates stable output frequency with extraordinary accuracy for Function Generator.

The traditional function generators typically use integrating circuit and constant current circuit techniques that are easily affected by operation temperature or the quality of resistor or capacitor and other key components to occur poor frequency accuracy. The innovative design for GFG-3015 is to get rid of these problems.

The frequency feedback system needs a compatible, powerful frequency counter. GW has designed his own full-function counter chip, GFC-9701, for this system with high frequency test range and full functions, including Period test, Duty test, Ratio test, Time interval, Pulse wide, direct display and direct connect with CPU system.

GFG-3015 uses this Chip to read output frequency value at any time. Then CPU will modify the correct value of D/A converter immediately according to this value, so that the user can get a high accuracy frequency from GFG-3015 Function Generator.

Besides, the GFG-3015 can also generate a high accuracy frequency to provide high frequency resolution.

**Graph1 indicates the fundamental construction of a frequency feedback system.**

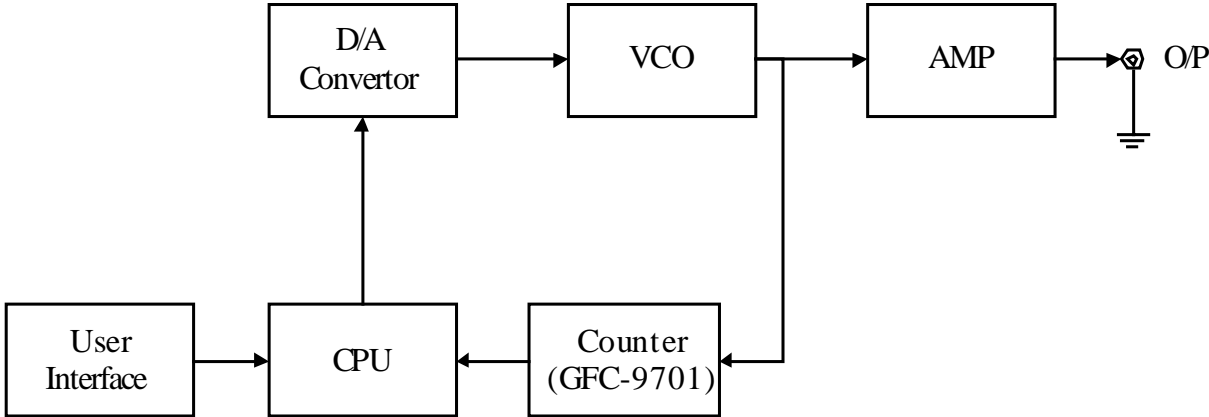

Except the different design from the typical circuit, GFG-3015 system also has micro controller (CPU unit) equipping an additional RS-232 interface functions which will be used on any test system with other instrument or to be controlled by computer.

### 3. Features

GFG-3015 is a functional Function generator that applies Frequency feedback control system technique and can generate high frequency accuracy with high resolution. Its main signal source can generate waveforms including sine wave, square wave, triangle wave, and ramp wave.

There are additional features listed as follows:

- ✧ All digitized operation user interface
- ✧ Output Waveforms of Sine, Square, Triangle, Ramp, Pulse, AM, FM, Sweep, Trigger and Gate or Burst.
- ✧ Wide output frequency range 0.01Hz ~ 15MHz.
- ✧ High frequency accuracy  $0.02\% \pm 5$  count.
- ✧ Maximum frequency resolution 10mHz.
- ✧ Dual displays indicate frequency and amplitude or other necessary information.
- ✧ Built-in 6-digit INT/EXT Function Counter and up to 150MHz frequency range with high resolution.
- ✧ INT/EXT AM/FM Modulation with internal modulation signal output.
- ✧ LIN/LOG Sweep Mode with internal sweep signal output.
- ✧ VCF of 100:1 EXT Frequency Control.
- ✧ SYNC Output.
- ✧ TTL Output.
- ✧ Synchronization GCV Output.
- ✧ Variable DC Offset Control
- ✧ Output Overload Protection
- ✧ RS232 Interface Standard



## 4. Specifications

<b>Output Waveforms</b>	Sine, Square, Triangle, $\pm$ Ramp, Pulse, AM, FM, Sweep, Trigger, Gate or Burst	
<b>Frequency Range</b>	10mHz~15MHz in 8 Frequency Range (auto switch)	
<b>Frequency Resolution</b>	1.5001MHz ~ 15.0000MHz ...(100Hz) 150.01kHz ~ 1.50000MHz...(10Hz) 15.001kHz ~ 150.000kHz...(1Hz) 1.5001kHz ~ 15.0000kHz...(0.1Hz); 150.01Hz ~ 1.50000kHz...(10mHz) 15.01Hz ~ 150.00Hz...(10mHz) 1.51Hz ~ 15.00Hz...(10mHz) 0.01Hz ~ 1.50Hz...(10mHz)	
<b>Frequency Accuracy</b>	0.02% $\pm$ 5 Count	
<b>Output Impedance</b>	50 $\Omega$ $\pm$ 10%	
<b>Amplitude</b>	Range	10.00V~0.01V (into 50 $\Omega$ ) 4 amplitude ranges   Vac peak   +   Vdc   < 5V
	Resolution	10mV(10.00V~0.01V)
	Accuracy	$\leq$ 3% $\pm$ 5count at 10Hz~1MHz $\leq$ 10% $\pm$ 5count at 1MHz~15MHz
	Unit	Vpp, Vrms, dBm
<b>DC Offset</b>	Range	$\pm$ 5V (into 50 $\Omega$ )   Vac peak   +   Vdc   < 5V
	Resolution	10mV
	Accuracy	$\leq$ 3% $\pm$ 3count at Amplitude Min.
<b>Duty</b>	Control Range	80%:20%:80% to 1MHz
	Resolution	1%
	Accuracy	$\leq$ 1% to 1MHz at 50% Duty
<b>Sync Output</b>	Impedance	50 $\Omega$ $\pm$ 10%
	Level	>1Vp-p open circuit
<b>Sine</b>	Distortion	$\leq$ 0.5%(-46dBc) From 10Hz~100kHz $\leq$ -30dBc To 15MHz (Spec. applied form 1Vpp to 10Vpp)
<b>Square</b>	Asymmetry	$\pm$ 1% of period + 3ns
	Rise or Fall Time	<18nSec
<b>Triangle and Ramp</b>	Linearity Error	<1% of full scale output at 100Hz

<b>Sweep</b>	Sweep Mode	Linear or Log sweep
	Sweep Range	150kHz~15MHz 15kHz~1.5MHz 1.5kHz~150kHz 150Hz~15kHz 15Hz~1.5kHz 1.5Hz~150Hz 0.15Hz~15Hz 0.01Hz~1.5Hz
	Width	>100:1(In Same Frequency Range)
	Rate	0.01Hz~10kHz
	Symmetry Control	90:10:90 ; Resolution:1%
	Sweep output	0 to $\geq$ -5Vp-p into 10k $\Omega$
	<b>Modulation</b>	Types
Waveform		Sine, Square, Triangle, Ramp or Variable Symmetry Pulse
Rate Frequency Range		10mHz~10KHz in 3 Frequency Range (auto switch)
Rate Frequency Accuracy		5% $\pm$ 1 count
Rate Frequency Resolution		10.0kHz~0.1kHz(100Hz) 99Hz~1Hz(1Hz) 0.99Hz~0.01Hz(0.01Hz)
Symmetry		90%:10%:90%; Resolution:1%
Symmetry Accuracy		$\pm$ 1 count( $\leq$ 1%)
Output Level		$\geq$ 1Vpp into 10k $\Omega$ load
Sine Wave Distortion		$\leq$ 2% from 10Hz to 10kHz
<b>Amplitude Modulation</b>		
Depth		0~100%
Modulation Frequency Rate		0.01Hz ~ 10kHz(INT) DC~1MHz(EXT)
Carries -3dB Bandwidth		<100Hz to >5MHz
External Sensitivity		$\leq$ 10Vpp for 100% modulation
<b>Frequency Modulation</b>		
Deviation		0~ $\pm$ 15%
Modulation Frequency Rate		0.01Hz ~ 10kHz(INT) DC ~ 50kHz(EXT)
External Sensitivity		$\leq$ 5Vpp for 15% deviation

<b>Trigger</b>	Start/Stop Phase Range	-90° ~ +80°
	Rate	0.01Hz~10kHz
	Frequency Range	0.1Hz ~ 1MHz(Useful to 10MHz)
	Ext Trig Frequency Range	DC to 1MHz,TTL compatible input level
	Gate or Burst	Implement by Trigger setting.
<b>VCF</b>	Range	100:1(0 to 10V± 1V) In Same Frequency Range
	Input Linearity	<0.5% to 1MHz,<5% to 10MHz
	Input Impedance	10 k Ω
<b>TTL Output</b>	Level	≥ 3Vpp
	Fan-out	>10 TTL Load
<b>GCV Output</b>	To set the voltage between 0.2V to 2V as per different Frequency in Same frequency Range	
<b>Frequency Counter</b>	INT/EXT	Switch Selector
	Range	5Hz~150MHz EXT
	Accuracy	Time Base(10MHz) Accuracy ± 1 count
	Time Base	± 20ppm(23°C ± 5°C) after 30 minutes warm up
	Resolution	The maximum resolution is 100nHz for 1Hz and 1Hz for 100MHz
	Input Impedance	1MΩ // 150pF
	Sensitivity	≤35mVrms(5Hz~100MHz); ≤45mVrms(100MHz~150MHz)
<b>Interface</b>	RS232	
<b>Accessories</b>	GTL-101 × 2, Instruction Manual × 1, Power cord × 1	
<b>Power Source</b>	115/ 230V AC ±15%, 50/60Hz	
<b>Dimensions</b>	290 (W) × 142 (H) × 346 (D) mm	
<b>Weight</b>	Approx. 5kg	

# 5. Front and Rear Panels

## Front Panel

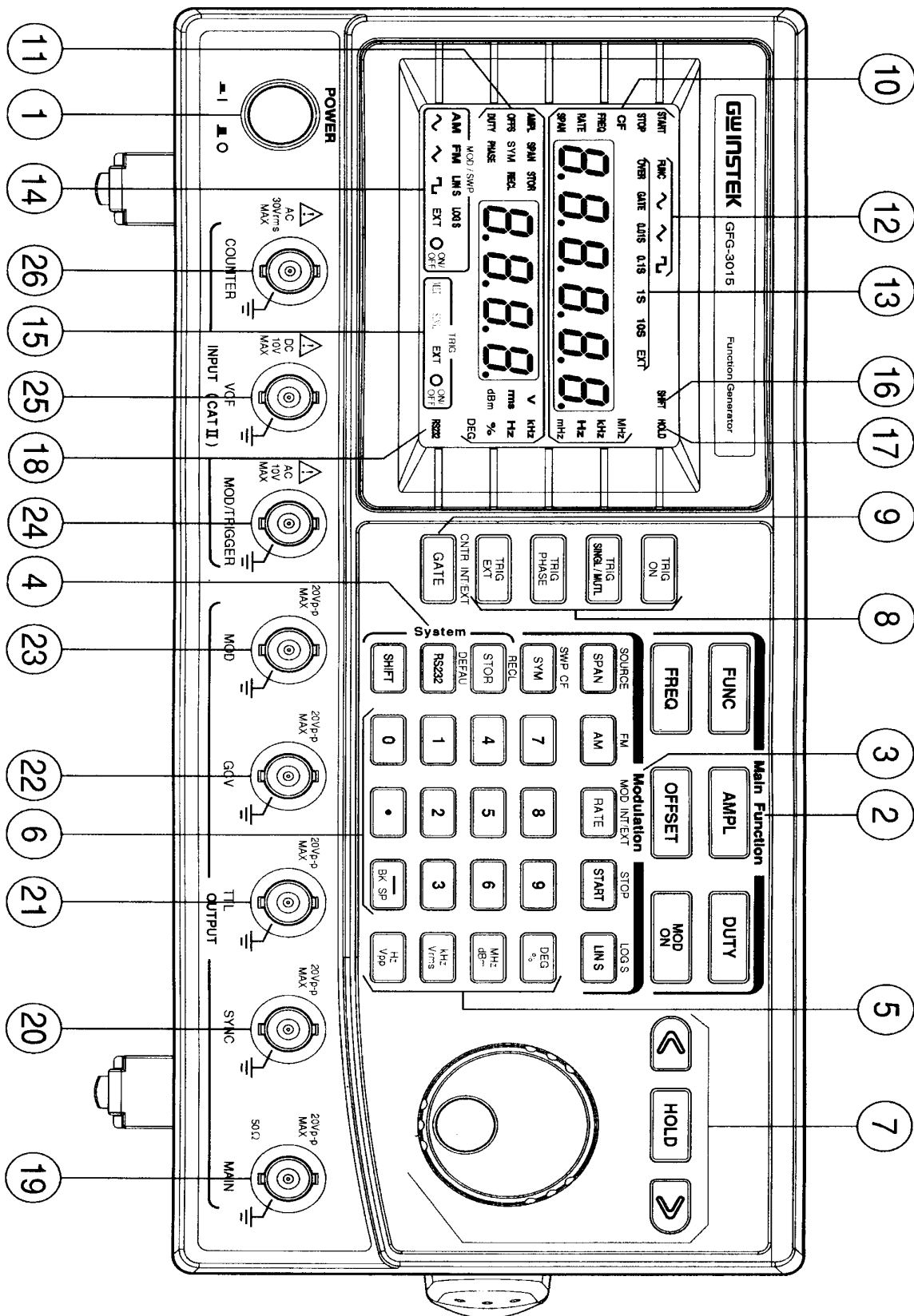

- ① POWER button : Push the button to turn on the power, and the display is activated. Push again the button to turn off the power.
- ② Main Function keys :
- FUNC** Key is to set main output waveform in the cycle of Sine, Triangle and Square. When the key is pressed, the related waveform LEDs will light up accordingly.
  - FREQ** Key is to set main frequency entry mode. Key in the desired value of frequency by using the number keys or Modify keys and Unit keys.  
When the key is pressed, the **FREQ** LED (on parameter display area A) will be flashing until other mode is set.
  - AMPL** Key is to set main amplitude entry mode. Key in the desired value of voltage by using the number keys or Modify keys and Unit keys.  
When the key is pressed, the **AMPL** LED (on parameter display area B) will be flashing until other mode is set.
  - OFFSET** Key is to set main output offset voltage entry mode. Key in the desired value of voltage by using the number keys or Modify keys and Unit keys.  
When the key is pressed, the **OFFS** LED (on parameter display area B) will be flashing until other mode is set.
  - DUTY** Key is to set main output Duty Cycle entry mode. Key in the desired value of percentage by using the number keys or Modify keys and Unit keys.  
When the key is pressed, the **DUTY** LED (on parameter display area B) will be flashing until other mode is set.
  - MOD/ON** Key is to start performing Amplitude Modulation, Frequency Modulation or Sweep function. When the key is pressed again, the functions will stop.  
When the key is pressed, the **ON/OFF** LED (on MOD/SWP Function LED area) will light up, press again the key, the LED will be off.
- ③ Modulation/Sweep Function keys :
- SOURCE**  
**SPAN** Key is to set Span of Modulation or Sweep entry mode and choose the source of modulation.  
If set to source choose function, must use Secondary Function mode.
  - FM**  
**AM** Key is to choose the type of modulation between AM and FM. If want to set to FM function, must use Secondary Function mode.
  - INT/EXT**  
**RATE** Key is to set Rate of Modulation, Sweep or Trigger entry mode and choose the signal source of Modulation, Sweep or Trigger.  
If want to set to signal, must use Secondary Functions mode.

**STOP**  
**START** Key is to set Start Frequency of Sweep entry mode and Stop Frequency of Sweep entry mode.  
 If set to Stop Frequency of Sweep entry mode, must use Secondary Functions mode.

**LOG S**  
**LIN S** Key is to choose the type of Sweep between liner sweep and LOG sweep.  
 If set to LOG sweep, must use Secondary Function mode.

**SWP CF**  
**SYM** Key is to set the Duty cycle of Modulation, Sweep or Trigger source entry mode. Key in the desired value of percentage by using number keys or modify keys and Unit keys. If want to set to center frequency of Sweep function that must use Secondary Functions mode.  
 When the key is pressed, the **SYM** LED (on parameter display area B) will be flashing until other mode is set.  
 When you use center frequency entry mode then the **CF** LED (In parameter display area A) will be flashing until other mode is set.  
 The detail operation of these keys. Please refer to the instruction in next Chapter.

4 System keys

**RECL**  
**STOR** Key is to save or reload the setup parameters of the instrument into or take out from memory; the selected number is from 0 to 9, up to 10 groups.





















**RS232**  
**RS232** Key is to start performing RS232 interface. Press the key then use rotational knob to change function states (ON or OFF).  
 Press the key again then use rotational knob to change the Baud rate. The cycle order is in 300, 600, 1200, 2400, 4800, 9600 and 19200 sequence.  
 If set the instrument to default state, must use Secondary Function mode.

**SHIFT** Key is to set the Secondary Functions mode. When the key is pressed, the instrument will choose Secondary Function and the **SHIFT** LED will light up.

For example, press **SHIFT** + can recall the default value of the instrument.

5 Unit keys

**DEG/%** **MHz/dB** **KHz/Vrms** **Hz/Vpp** In 'Normal' mode, these keys are used to assign the unit and to set the entered value. For example, you can use dBm and Vpp to set the output amplitude. They can be used to set frequency (MHz, kHz, Hz), OFFSET, and PHASE, etc.  
 In STOR or RECL modes, they are used as 'Enter'.

- ⑥ Entry keys :  To  and  keys are used to input value. A unit key should be pressed to set the entered value.  
 key is blank space that used to delete the entered value entirely and the other function is minus key .
- ⑦ Modify keys :   Keys are used to change the digit of input value.  
 User can use the Rotate knob for increasing or decreasing that digit.  
 Key to terminate the function of all Modify keys until user press this key again.  
 When the key is pressed, the  LED will light up until the key is pressed again.
- ⑧ Trigger Function keys :  Key is to start performing Trigger function mode. If the key is pressed again, the function will stop.  
 When the key is pressed, the  LED (In Trigger Function LED area) will light up until the key is pressed again (The LED will light off).  
 Key is to choose the type of Trigger, Single-trigger or multi-trigger.  
 When the key is pressed, the  or  LED (In Trigger Function LED area) will light up accordingly.  
 Key is to set the phase of trigger function entry mode. Key in the desired value of percentage by using number keys, modify keys and Unit keys.  
 When the key is pressed, the  LED (In parameter display area B) will be flashing until other mode is set.  
 Key is to choose the Trigger signal source, internal or external.  
 When the key is pressed, the  LED (In Trigger Function LED area) will light up accordingly until the key is pressed again (The LED will light off).
- ⑨ Counter Function key :  Key is to set the Gate time of External counter function. The cycle order is according to 0.01s, 0.1s, 1s, and 10s. When the key is pressed, the Gate time LEDs will light up according user's wish.  
 The other function is to choose input signal source of counter, internal or external, by using Secondary Function mode.
- ⑩ Parameter display Area (A) : The 6-digit Parameter display presents the parameter values and information about the current status and unit.  
 The  LED light on indicated that the value of display was Start frequency of sweep function right now.  
 The  LED light on indicated that the value of display was Stop frequency of sweep function right now.  
 The  LED light on indicated that the value of display was center frequency of sweep function right now.

⑪ Parameter display Area (B)

The **FREQ** LED light on indicated that the value of display was main output frequency right now.

The **RATE** LED light on indicated that the value of display was rate frequency of sweep or modulation or trigger function right now.

The **SPAN** LED light on indicated that the value of display was Span frequency of sweep function right now.

The **MHz**, **KHz**, **Hz** and **mHz** LED light on indicated that unit according current value of display.

: This 4-digit Parameter display presents the parameter values and information about the current status and unit.

The **AMPL** LED light on indicated that the value of display was main output amplitude right now.

The **OFFS** LED light on indicated that the value of display was main output DC offset voltage right now.

The **DUTY** LED light on indicated that the value of display was main output duty cycle right now.

The **SPAN** LED light on indicated that the value of display was span frequency of modulation function right now.

The **SYM** LED light on indicated that the value of display was modulation signal duty cycle of sweep or modulation or trigger function right now.

The **PHASE** LED light on indicated that the value of display was phase of trigger function right now.

The **STOR** LED light on indicated that the value of display was save group number right now.

The **RECL** LED light on indicated that the value of display was reload group number right now.

The **V**, **rms**, **dBm**, **KHz**, **Hz**, **%** and **DEG** LED light on indicated that unit according current value of display.

⑫ Waveform Function LEDs

: These LEDs indicate the figure of main output waveform and the current operation functions.

⑬ Counter Functions LEDs

: These LEDs indicate the GATE TIME of external counter and the current value.

⑭ Modulation/Sweep Function LEDs

: These LEDs indicate the current status of Sweep and Modulation and the current operation functions.

The **AM** LED lights on to indicate the setting status of amplitude modulation function.

The **FM** LED lights on to indicate the setting status of frequency modulation function.

The **LIN** LED lights on to indicate the setting status of liner sweep function.

The **LOG** LED lights on to indicate the setting status of LOG sweep function.

The **Sine**, **Triangle** and **Square** LED light on indicated that according Modulation source waveform.

The **EXT** LED lights on to indicate the external sweep or modulation signal source.

The **ON/OFF** LED lights on to indicate that the sweep or modulation function is enabled.



- ⑮ Trigger Function LEDs : These LEDs indicate the current status of trigger function on display and the current operation functions.  
 The **MULT** LED lights on to indicate the trigger setting status of multi-trigger type.  
 The **SINGL** LED lights on to indicate the trigger setting status of Single-trigger type.  
 The **EXT** LED lights on to indicate the external trigger signal source.  
 The **ON/OFF** LED lights on to indicate that the trigger function is enabled.
- ⑯ Shift mode LED : The **SHIFT** LED light on indicated that the enter mode is Secondary Functions right now.
- ⑰ Hold mode LED : The **HOLD** LED lights on to indicate that all modify keys is disabled.
- ⑱ RS-232 Interface LED : The **RS232** LED indicates the current operation status with the RS-232 interface bus.
- ⑲ Main Output BNC : This is the BNC connector that outputs all main signals. Output resistance is 50Ω.
- ⑳ Sync Output BNC : This is the BNC connector that outputs sync signals. Output resistance is 50Ω.
- ㉑ TTL Output BNC : This is the BNC connector that outputs TTL level signals.
- ㉒ GCV Output BNC : This is the BNC connector that outputs the voltage between 0.2V and 2V varied with different Frequency
- ㉓ Modulation/Sweep Output BNC : This is the BNC connector that outputs internal Sweep or modulation signals. Output Impedance is 10kΩ.
- ㉔ EXT Modulation/Trigger Input BNC : This is the BNC connector for EXT amplitude/frequency modulation or EXT sweep signal input.  
 The amplitude modulation index is 100% when  $\leq 10V_{pp}$  is input.  
 The frequency modulation index is 15% when  $\leq 5V_{pp}$  is input.  
 The trigger mode input signal is compatible with TTL level.
- ㉕ VCF Input BNC : This is the BNC connector for VCF signal input.  
 The frequency variation width index is 100:1 when  $10V \pm 1V$  is input. Input Impedance is 10kΩ.
- ㉖ EXT Counter Input BNC : This is the BNC connector for external counter signal input.  
 The Input Impedance is  $1M\Omega // 150pF$

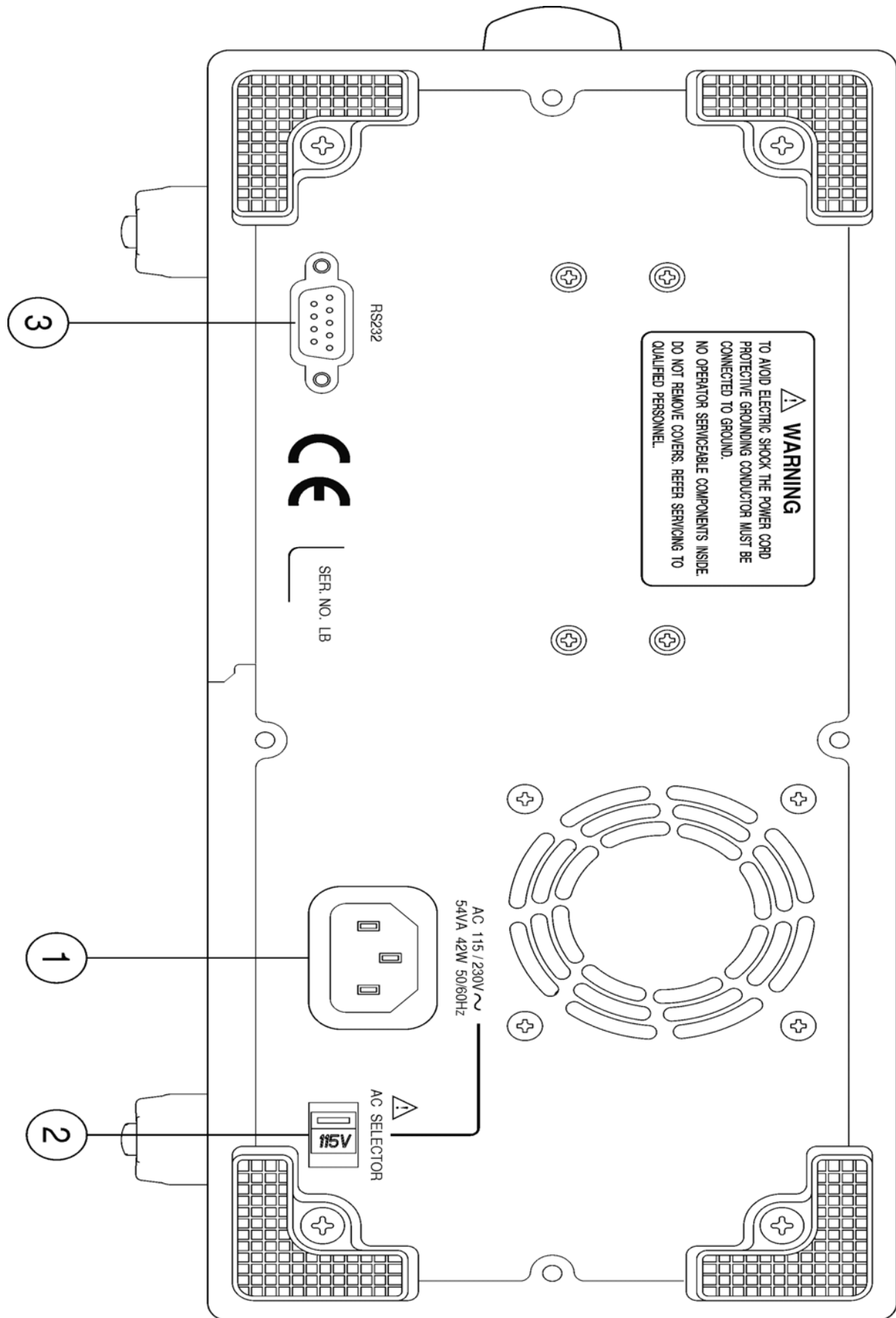

# Rear Panel



- ① Power Entry model : This is the AC power input terminal. AC input should be within the range of line voltage $\pm 15\%$ , 50/60Hz.
- ② Line Voltage Selector : This switch can choose the current line voltage between 115V and 230V
- ③ RS232 connector : This is the port of serial RS232 interface. The DCE and Baud rate is among 300 ~ 19.2k.

## 6. Operation





### 6.1 The First Step Setup For Instrument

- ❶ Ensure that the voltage of main supply is compatible with this instrument. The selector on the rear panel states the required AC line voltage.
- ❷ Connect the instrument to main supply with the power cord.
- ❸ Press the Power Switch, all control functions will be shown on the parameter display area.
- ❹ Press  +  can recall the default value of this instrument.

### 6.2 The Setup of Output Function

- ❶ Press  key to select main output waveform. The Waveform will change when you press this key each time. The cycle order is according to Sine, Triangle, Square.  
When the key is pressed, the waveform LEDs will light up according to the mentioned cycle order of output waveform.
- ❷ Set different duty cycle ratio (not 50%) for Triangle or Square waveform to get  $\pm$ Ramp or different Pulse width square waveform.

### 6.3 The Setup of Frequency

- ❶ Set to Frequency Entry mode by pressing  button, the  LED (In parameter display area A) will be flashing.
- ❷ Key in the desired value of frequency.
- ❸ Select a proper unit-button to specify the value.
- ❹ In addition, you can use   and the Rotate Knob to adjust the main frequency value you need.

**Note:** The frequency range of this instrument is from 10mHz to 15MHz in 8 Frequency Range. The details and resolution is as below. But those ranges will auto switch according to the enter value.



Frequency Range	10mHz~15MHz in 8 Frequency Range (auto switch)
<b>Frequency Resolution</b>	1.5001MHz ~ 15.0000MHz...(100Hz) 150.01kHz ~ 1.50000MHz...(10Hz) 15.001kHz ~ 150.000kHz...(1Hz) 1.5001kHz ~ 15.0000kHz...(0.1Hz); 150.01Hz ~ 1.50000kHz...(10mHz) 15.01Hz ~ 150.00Hz...(10mHz) 1.51Hz ~ 15.00Hz...(10mHz) 0.01Hz ~ 1.50Hz...(10mHz)

#### ❖ Example of the Setup Frequency





1. To set frequency at 250Hz

Press  first, then key in    and press .

2. To modify the frequency to 850Hz.



Press  or  to move flash digit to “ 2 ” position.  
Then turn the Rotate Knob clockwise until the digit become to “ 8 ”.

## 6.4 The Setup of Amplitude



- ① Set to Main Amplitude entry mode by pressing  button to, now the  LED (In parameter display area B) will be flashing.
- ② Key in the desired value of Amplitude.
- ③ Select a proper unit-button to specify the value.
- ④ In addition, you can use  or  and the Rotate Knob to modify the main Amplitude value you need.

### ❖ Example of the Setup Amplitude

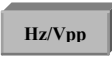
1. To set Amplitude at 8 Vpp.





Press  first, then key in  and press .

2. To modify the Amplitude to 5 Vpp.

Press  or  to move flash digit to “ 8 ” position.  
Then turn the Rotate Knob anti-clockwise until the digit become to “ 5 ”.

The input limit : (1) Amplitude should be among 0.01 ~ 10Vpp.  
(2) Offset should be among  $\pm 5$ Vpp.  
(3)  $AMPL + |2 \times OFFSET| \leq 10Vpp$ .

## 6.5 The Setup of Offset



- ① Set to main DC offset Voltage entry mode by pressing  button, now the  LED (In parameter display area B) will be flashing.
- ② Key in the desired value of DC offset voltage.
- ③ Select a proper unit-button to specify the value.
- ④ In addition, you can use  or  and the Rotate Knob to modify the main DC offset voltage value you need.

### ❖ Example of the Setup Offset

1. To set DC offset voltage at 1 Vpp.





Press  first, then key in  and press .

2. To modify offset voltage to 2 Vpp.

Press  or  to move flash digit to “ 1 ” position.  
Then turn the Rotate Knob clockwise until the digit become to “ 2 ”.

The input limit : (1) Amplitude should be among 0.01 ~ 10Vpp.  
(2) Offset should be among  $\pm 5$ Vpp.  
(3)  $AMPL + |2 \times OFFSET| \leq 10Vpp$ .

## 6.6 The Setup of Duty



- 1 Set Duty cycle of Main output entry mode by pressing  button, the  LED (In parameter display area B) will be flashing.
- 2 Key in the desired value of Duty cycle.
- 3 Key in the specific value by using Unit button.
- 4 In addition, you can use   and the Rotate Knob to modify the Duty cycle of Main output value you need.

### ❖ Example of the Setup Duty

1. To set Duty cycle at 60%.

Press  first, then key in   and press .

2. To modify Duty cycle to 30%.





Press  or  to move flash digit to “ 6 ” position.

Then turn the Rotate Knob anti-clockwise until the digit become to “ 3 ”.

The input limit: 80%:20%:80% at 1MHz.

## 6.7 The Setting of STORE

The Store button is used to save the setup parameters of the instrument into its memory with the stored group number from 0 to 9, up to 10 groups totally.

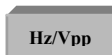
- 1 Push  button.
- 2 Key in the group number from 0 to 9.
- 3 Press any button from    or  to complete the setting.





### ❖ Example of the Setup STOR

To save a parameter to the RAM of group #5.

Press  first, then key in  and press .

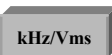
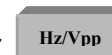

## 6.8 The Setting of RECALL

The Recall button can retrieve the parameters saved in the RAM.



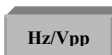

- 1 Push  and  button.
- 2 Key in the group number from 0 to 9.
- 3 Press any button from    or  to complete the setting.

### ❖ Example of the Setup RECALL











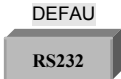



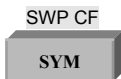

To retrieve a parameters from the RAM of group #6.

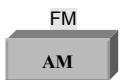
Press  and  first, then key in  and press .

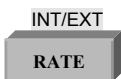
## 6.9 The SHIFT Key and Function Keys





The  button is used to enable the secondary function of certain function keys with blue printed letters. After pressing the  button, The  LED will light up, only the buttons with blue printed letters are working. To release the secondary function by pressing  again.



### ❖ The Secondary Functions

1.  +  Return to the default status of GFG-3015.
2.  +  Retrieve the setup parameters from memory;
3.  +  Display sweep center frequency and get into enter mode.
4.  +  Change the Modulation source.
5.  +  Set Frequency modulation function.
6.  +  Choose the Modulation type.
7.  +  Display Sweep stop frequency and get into enter mode.
8.  +  Set LOG sweep function.
9.  +  Choose the Counter signal source.

## 6.10 Setup of LIN or LOG Sweep

GFG-3015 can adopt frequency to sweep its function output for triangle and ramp waves. The type of sweep can be set as linear or log sweep.

- ❶ Select a main waveform by using  button.
- ❷ Select a main output amplitude by using  button.
- ❸ Select the sweep mode by using  button.
- ❹ Press  to set up sweep RATE value (Range from 0.01Hz to 10kHz).

- 5 Set the starting frequency by pressing  button and terminate sweep frequency by pressing  +  .

The start and stop frequency must be at the same sweep frequency range. Please refer to the Note 2 for the details.

The sweep can also be done by enter Center frequency or Span frequency.

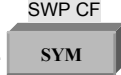
Press  +  for center frequency entry mode (Note 3).

Press  for span frequency entry mode (Note 3).

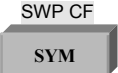
- 6 Press  to set the Duty of sweep signal (Range 90%:10%:90%).

- 7 Press  to initiate sweeping.

**Note: 1.** Please refer to the setup of LIN and LOG Sweep as the sample below.

- 2.** Because all frequency range (0.01Hz ~ 15MHz) of GFG-3015 are composed of 8 frequency ranges (The details as below), So the value of start and stop frequency must be at the same sweep range.

Sweep Range	150kHz ~15MHz 15kHz ~1.5MHz 1.5kHz ~150kHz 150Hz ~15kHz 15Hz ~1.5kHz 1.5Hz ~150Hz 0.15Hz ~15Hz 0.01Hz ~1.5Hz
-------------	---

- 3.** The bandwidth [SPAN] = stop frequency - start frequency  
 The center frequency = [(stop frequency + start frequency)/2]  
 The start frequency = center frequency of the sweep - bandwidth/2  
 The stop frequency = center frequency of the sweep + bandwidth/2  
 The start and stop frequencies can be freely set according to the users' preference.
- 4.** It won't make any change on execution and result by taking different step sequence.
- 5.** GFG-3015 can output waveform synchronizing with its sweep function. In the example of setting up LIN sweep, the Modulation output terminal will output the waveform of triangle at 1Hz.

















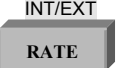

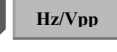

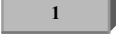
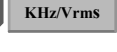

### ❖ Example of the Setup of LIN Sweep

To set the following conditions:

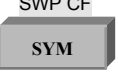
- ♦ Output function : Sine Wave.
- ♦ Output Amplitude : 10Vpp.
- ♦ Sweep mode : LIN.
- ♦ Speed :1 second.
- ♦ Start frequency : 1kHz.
- ♦ Stop frequency : 10kHz.
- ♦ Sweep signal symmetry: 50%.

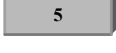

Procedure:

- ① Press  to select SINE wave for main output.
- ② Press     in sequence.
- ③ Then press  to select linear sweep mode.
- ④ Press     in sequence.
- ⑤ Press     in sequence.
- ⑥ Press       in sequence.
- ⑦ Press      in sequence.
- ⑧ Press 
- ⑨ The Modulation/Sweep Output BNC will output 1Hz Triangle wave.















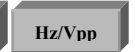



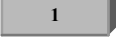
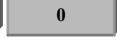
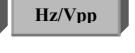

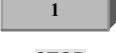
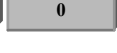
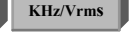
In addition, you can use   and the Rotate Knob to modify the value you need.

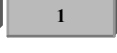
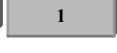
### ❖ Example of the Setup of LOG Sweep

To set the following conditions:

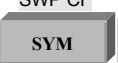
- ♦ Output function: Triangle Wave.
- ♦ Output amplitude: 10Vpp.
- ♦ Sweep mode: LOG.
- ♦ Speed: 0.1 second.
- ♦ Start frequency: 10kHz.
- ♦ Stop frequency: 100kHz.
- ♦ Sweep signal symmetry: 90%.

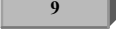
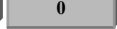
Procedure:

- ① Press  to select TRIANGLE wave for main output.
- ② Press     in sequence.
- ③ Then press   to select LOG sweep mode.
- ④ Press      in sequence.
- ⑤ Press      in sequence.
- ⑥ Press        in sequence.
- ⑦ Press      in sequence.

⑧ Press **MOD/ON** .

⑨ The Modulation/Sweep Output BNC will output the 10Hz LOG wave.

In addition, you can use **◀ ▶** and the Rotate Knob to modify the value you need.

### ❖ Error message for Sweep Function

Because all frequency range (0.01Hz ~ 15MHz) of GFG-3015 are composed of 8 frequency ranges, So the Sweep function has specific restriction on the start and stop frequency. If the value of start and stop frequency not at the same sweep range, then the instrument will show the message to user.

Basically, The message is a suggestion that remind user of selecting a proper sweep frequency range and amend the start or stop frequency.

Please refer to the sample below:

To set the following conditions:

- ♦ Start frequency: 100Hz.
- ♦ Stop frequency: 1MHz.

Procedure:

- ① Press **LOG S** **LIN S** to select linear sweep mode.
- ② Press **STOP** **START** **1** **0** **0** **Hz/Vpp** in sequence.
- ③ Press **STOP** **SHIFT** **START** **1** **MHz/dB** in sequence.
- ④ Press **MOD/ON** .













When the **MOD/ON** key is pressed, The Display area will show reminding message (The detail as below) If the input sweep ranges out of correct range, The instrument will according to start and stop frequency to suggest possible sweep range.

In this sample, The message of “15Hz – 1500Hz or 15kHz – 1500kHz” range will be provided. Because the input start frequency is at 100Hz, so “15Hz – 1.5kHz” can match up the requirement. Besides, the stop frequency is at 1MHz, so “15kHz – 1.5MHz” is close to range requirement. After show the message, The Display area will back to original state (Before press the button).

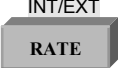

## 6.11 Setup of AM Modulation

The AM modulation function offers internal sine, square, and triangle (ramp) signals. Besides, You can select the modulation signal from external (Modulation/Trigger Input BNC).

- ❶ Set the main output function by using  button .
- ❷ Set the main output frequency by using  button and number keys.
- ❸ Set the main output Amplitude by using  button and number keys.
- ❹ Select the modulation mode by using  button.
- ❺ Select the modulation signal source by using  +  .
- ❻ Press  to set up modulation RATE value (Range 0.01Hz ~ 10kHz).
- ❼ Select the modulation signal by pressing  +  buttons.  
GFG-3015 offers sine, square, and triangle (ramp) signals for internal modulation.
- ❽ Select the amplitude modulation depth by pressing  buttons (Range 100%).
- ❾ Press  to set the Duty of modulation signal (Range 90%:10%:90%).
- ❿ Press  to start performing amplitude modulation.

- Note:**
1. Please refer to the setup of amplitude modulation as the example below.
  2. When the modulation signal sources from external are selected, the Rate, Span (Depth), Symmetry and source selection will disable as these functions are operated on internal source mode only.
  3. It won't make any change on execution and result by taking different step sequence.
  4. GFG-3015 can output waveform synchronizing with its modulation function. In the example of setting up amplitude modulation, the Modulation output terminal will output the waveform of sine at 100Hz.

















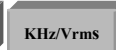



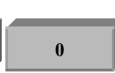
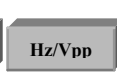

### ❖ Example of the Setup of AM Modulation

To set the following conditions:

- ♦ Main function: Sine Wave.
- ♦ Main Frequency: 10kHz.
- ♦ Main Output Amplitude: 10Vpp
- ♦ Modulation Mode: Amplitude
- ♦ Modulation Source: INT
- ♦ Modulation rate: 100Hz.
- ♦ Modulation Signal Source: Sine.
- ♦ Modulation Depth: 80%.
- ♦ Modulation Signal Symmetry: 50%.

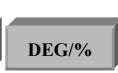
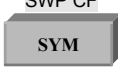
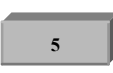
Procedure:

- ❶ Press  to select SINE wave for main output.











- ② Press     in sequence.
- ③ Then press     in sequence.
- ④ Press  to set AM mode.
- ⑤ Press   to select the source from internal signal.
- ⑥ Press      in sequence.
- ⑦ Press   to select the modulation signal on SINE wave.
- ⑧ Press     in sequence.
- ⑨ Press     in sequence.
- ⑩ Press .

The MOD Output BNC will output 100Hz sine wave.

In addition, you can use   and the Rotate Knob to modify the value you need.

## 6.12 Setup of FM Modulation

The FM modulation function offers internal sine, square, and triangle (Ramp) signals. Besides, you can select the modulation signal from external (Modulation/Trigger Input BNC).

- ① Set the main output function by pressing  button.
- ② Set the main output Amplitude by pressing  button and number keys.
- ③ Set the main output frequency by pressing  button and number keys.
- ④ Select the modulation mode by pressing  +  buttons.
- ⑤ Select the modulation signal source by pressing  +  buttons.
- ⑥ Press  to set up modulation RATE value (Range 0.01Hz ~ 10kHz).
- ⑦ To select the modulation signal by pressing  and  buttons. GFG-3015 offers sine, square, and triangle (ramp) signals for internal modulation.

- ⑧ To select the Frequency modulation deviation by pressing  buttons.  
(Range  $\pm 15\%$ ).

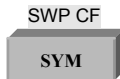
- ⑨ Press  to set the Duty of modulation signal (Range 90%:10%:90%).

- ⑩ Press  to start performing frequency modulation.

**Note: 1.** As all frequency range (0.01Hz ~ 15MHz) of GFG-3015 are composed of 8 frequency ranges (The details as below), When the main frequency in FM function is set, a reasonable Span must be considered.

For example, If set the main frequency at 1.4MHz (Range 7) and set Span at 10%, the corrected frequency vibration is from 1.26MHz to 1.54MHz and it will be over Range 7. Therefore, the FM result is faults now, the Span must be reduced in order to get a reasonable result.

Number of Range	Main Setting Frequency	FM variation Range
8	1.5001MHz ~ 15.0000MHz	150kHz~15MHz
7	150.01kHz ~ 1.50000MHz	15kHz~1.5MHz
6	15.001kHz ~ 150.000kHz	1.5kHz~150kHz
5	1.5001kHz ~ 15.0000kHz	150Hz~15kHz
4	150.01Hz ~ 1.50000kHz	15Hz~1.5kHz
3	15.01Hz ~ 150.00Hz	1.5Hz~150Hz
2	1.51Hz ~ 15.00Hz	0.15Hz~15Hz
1	0.01Hz ~ 1.50Hz	0.01Hz~1.5Hz

2. Please refer to the setup of frequency modulation as the example below.
3. When the modulation signal source external is selected, the Rate, Span (Deviation), Symmetry and source selection will disable as those functions are workable on internal source mode only.
4. It won't make any change on execution and result by taking different step sequence.
5. GFG-3015 can output waveform synchronizing with its modulation function. In the example of setting up frequency modulation, the "Modulation output terminal" will output the waveform of sine at 1kHz.



















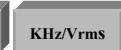

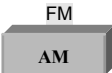

#### ❖ Example of the Setup of FM Modulation

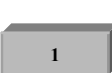
To set the following conditions:

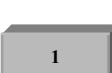

- ◆ Main function: Sine Wave.
- ◆ Main Frequency: 100kHz.
- ◆ Main Output Amplitude: 10Vpp.
- ◆ Modulation Mode: Frequency
- ◆ Modulation Source: INT
- ◆ Modulation rate: 1kHz.
- ◆ Modulation Signal Source: Sine.
- ◆ Modulation Deviation: 10%.
- ◆ Modulation Signal Symmetry: 50%.

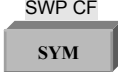
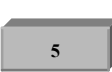
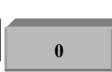
Procedure:

- ① Press  to select SINE wave for main output.









- ② Press     in sequence.
- ③ Then press      in sequence.
- ④ Press   to set FM mode.
- ⑤ Press   to select the source from internal signal.
- ⑥ Press    in sequence.
- ⑦ Press   to select the modulation signal on SINE wave.
- ⑧ Press     in sequence.
- ⑨ Press     in sequence.
- ⑩ Press .

The MOD Output BNC will output the 1kHz sine wave.

In addition, you can use   and the Rotate Knob to modify the value you need.

## 6.13 Setup of Trigger

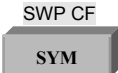
The Trigger function offers internal trigger source signals. Besides, You can select the signal from external (From Modulation/Trigger Input BNC).

- ① Set the main output function by pressing  button .
- ② Set the main output Amplitude by pressing  button and number keys.
- ③ Set the main output frequency by pressing  button and number keys.
- ④ Select the Trigger type by pressing  button.
- ⑤ Select the Trigger signal source by pressing  button.
- ⑥ Press  to set up Trigger signal RATE value (Range 0.01Hz ~ 10kHz).
- ⑦ Press  to set the Duty of Internal trigger signal (Range 90%:10%:90%).
- ⑧ Select the Trigger start Phase by pressing  button and number keys.  
GFG-3015 offers -90° ~ +80° range for internal trigger mode.
- ⑨ Press  to start performing Trigger function.

**Note: 1.** Please refer to the setup of Trigger function as the example below.













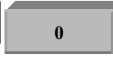





2. When the Trigger signal source from external is selected, the Rate, Phase, and Symmetry will disable as those functions are workable on internal trigger mode only.
3. It won't make any change on execution and result by taking different step sequence.
4. The Trigger function of GFG-3015 must meet the important setting condition with the Main frequency higher than Trigger rate frequency!

### ❖ Example of the Setup of Trigger Function

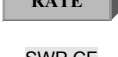
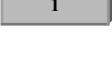
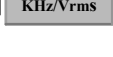
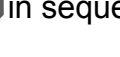
To set the following conditions:

- ♦ Main function: Sine Wave.
- ♦ Main Frequency: 5kHz.
- ♦ Main Output Amplitude: 10Vpp.
- ♦ Trigger type: Multi-trigger
- ♦ Trigger Source: INT
- ♦ Trigger Signal rate: 1kHz.
- ♦ Trigger Phase: 30°.
- ♦ Trigger Signal Symmetry: 50%.

Procedure:

- ❶ Press  to select SINE wave for main output.
- ❷ Press     in sequence.
- ❸ Then press    in sequence.
- ❹ Press  to set Trigger Type on Multi-Trigger .
- ❺ Press  to select the source from internal signal.
- ❻ Press    in sequence.
- ❼ Press     in sequence.
- ❽ Press     in sequence.
- ❾ Press  .
- ❿ The Trigger Function will perform on output terminal. Please see **Figure (1)**.

Besides, you can use   and the Rotate Knob to modify the value you need.

### ❖ Another Example of the Setup of Trigger Function

All the setting conditions are the same as above mentioned examples except the one set “Single-trigger” of the Trigger Type.

- ♦ Trigger type: Single-Trigger

Procedure:

- ❶ Press  to set Trigger Type to Single-Trigger .
- ❷ The Trigger Function will perform on output terminal. Please see **Figure (2)**.

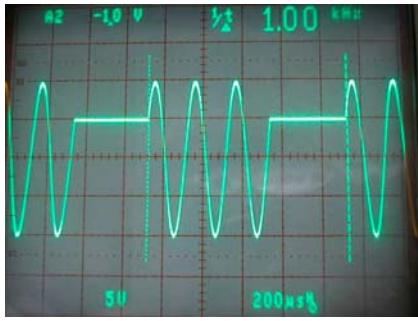

Figure (1)



Figure (2)

## 6.14 Setup of GATE and BURST

The GFG-3015 provides GATE or BURST function performed with different Trigger settings. If want to set to GATE or BURST function, just proceed some simple calculation and some Trigger setting.

Please refer the setup of GATE or BURST function as the example below.

### ❖ Example of the Setup of BURST

- The detailed calculated formula for BURST as below:
  1. Trigger Rate period = Burst period.
  2. Symmetry of Trigger signal =  $100\% - \left\{ \frac{[\text{Burst period} - (\text{Burst count} \times \text{Main Frequency period})]}{\text{Burst period}} \right\} \times 100\%$
- The Burst period > Burst Count × Main Frequency period.
- Set the Trigger Type to Multi-Trigger type.
- Because the Frequency and Symmetry of Trigger signal have their own accuracy that is different than main frequency, therefore, when the above formula is used to calculate the Symmetry, the value might have to be modified to match the Burst count as desired.

To set the following conditions for BURST function example:

- ♦ Main function: Sine Wave.
- ♦ Main Frequency: 1kHz(1mS).
- ♦ Main Output Amplitude: 10Vpp.
- ♦ Burst period: 10ms
- ♦ Burst count: 3.

Procedure:

- ❶ The calculation of setting:
  1. Trigger Rate = Burst period = **10mS**(100Hz)
  2. Symmetry of Trigger signal =  $100\% - \left\{ \frac{[10\text{mS} - (3 \times 1\text{mS})]}{10\text{mS}} \right\} \times 100\% = 30\%$
- ❷ Press **FUNC** to select Sine wave for main output.
- ❸ Press **AMPL** **1** **0** **Hz/Vpp** in sequence.
- ❹ Then press **FREQ** **1** **KHz/Vrms** in sequence.
- ❺ Press **SIGL/MUT** to set Trigger Type on Multi-Trigger .
- ❻ Press **TRIG EXT** to select the source from internal signal.



⑦ Press      in sequence.

⑧ Press     in sequence.

⑨ Press    in sequence.

⑩ Press .

The BURST Function will perform on output terminal. Please see **Figure (3)**.

In addition, you can use   and the Rotate Knob to modify the value of Trigger signal Symmetry and set the Burst count you need.

- Note:**
1. It won't make any change on execution and result by taking different step sequence.
  2. Use suitable external signal to set the BURST function you need.

### ❖ Example of the Setup of GATE

- The detailed calculate formula of GATE function as below:
  1. Trigger Rate period = Gate period.
  2. Symmetry of Trigger signal =  $100\% - \{[(\text{Gate period} - \text{Open Gate time}) / \text{Gate period}] \times 100\%\}$
- The Gate period > Open Gate time.
- Set the Trigger Type to Multi-Trigger type.
- Because the Frequency and Symmetry of Trigger signal have their own accuracy that is different than main frequency, therefore, when the above formula is used to calculate the Open Gate time, the value might have to be modified to close your desire. It's a normal phenomenon that the Open Gate time may have less accuracy than your wish.

To set the following conditions for Gate function Example:



- ♦ Main function: Triangle Wave.
- ♦ Main Frequency: 1kHz(1mS).
- ♦ Main Output Amplitude: 10Vpp.
- ♦ Gate period: 10mS
- ♦ Open Gate Time: 6mS.

Procedure:

- ① The calculation of setting:
  1. Trigger Rate = Gate period = 10ms(100Hz)
  2. Symmetry of Trigger signal =  $100\% - \{[(10\text{mS} - 6\text{mS}) / 10\text{mS}] \times 100\%\} = 60\%$

② Press  to select Triangle wave for main output.

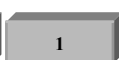
③ Press     in sequence.

④ Then press    in sequence.

⑤ Press  to set Trigger Type to Multi-Trigger.

⑥ Press  to select the source from internal signal.

⑦ Press **INT/EXT** **RATE** **1** **0** **0** **Hz/VDD** in sequence.

⑧ Press **SWP CF** **SYM** **6** **0** **DEG/%** in sequence.

⑨ Press **PHASE** **0** **DEG/%** in sequence.

⑩ Press **TRIG ON**.

The GATE Function will perform on output terminal. Please see **Figure (4)**.

In addition, you can use **◀** **▶** and the Rotate Knob to modify the value of Trigger signal Symmetry and set the Open Gate Time you need.

**Note:** 1. It won't make any change on execution and result by taking different step sequence.

2. Use suitable external signal to set the GATE function you need.

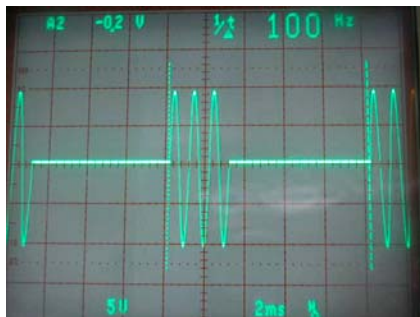

**Figure (3)**

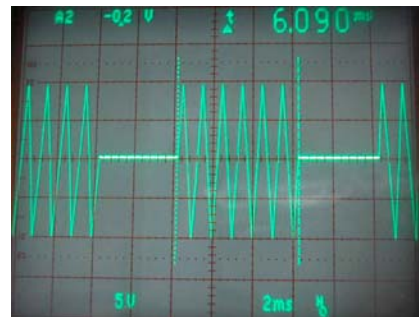

**Figure (4)**

## 6.15 Setup of External Counter

The GFG-3015 provides a high performance external frequency counter and with 6 digits counter and up to 150MHz high frequency range with high resolution.

① Press **SHIFT** **INT/EXT** button, the **EXT** and one of the Gate time indicated LEDs will light up, also, the **GATE** will be flashing according to the Gate time of Counter (In Counter Functions LEDs area). Now, the external counter is in enabling status.

② When the **INT/EXT** **GATE** is pressed, the Gate time LEDs will be according to the cycle of **0.01S**, **0.1S**, **1S**, and **10S** to display. The Different Gate time will provide different resolution of counter. So users can use the key to choose whatever the resolution they need.

The detailed relation among the Test frequency, the Gate time, the State LEDs and minimum resolution is as below:

Input Test Frequency	Gate Time	Display Value	State of LEDs	Resolution
1Hz	0.01 Sec	1.0000	<b>Hz</b>	100 $\mu$ Hz
	0.1 Sec	1.00000	<b>Hz</b>	10 $\mu$ Hz

	1 Sec	1.00000	Hz	10 $\mu$ Hz
	10 Sec	000.000	mHz, OVER	1 $\mu$ Hz
10Hz	0.01 Sec	10.000	Hz	1mHz
	0.1 Sec	10.0000	Hz	100 $\mu$ Hz
	1 Sec	10.0000	Hz	100 $\mu$ Hz
	10 Sec	0.00000	Hz, OVER	10 $\mu$ Hz
100Hz	0.01 Sec	100.00	Hz	10mHz
	0.1 Sec	100.000	Hz	1mHz
	1 Sec	100.000	Hz	1mHz
	10 Sec	00.0000	Hz, OVER	100 $\mu$ Hz
1kHz	0.01 Sec	1.0000	kHz	100mHz
	0.1 Sec	1.00000	kHz	10mHz
	1 Sec	1.00000	kHz	10mHz
	10 Sec	000.000	Hz, OVER	1mHz
1MHz	0.01 Sec	1.0000	MHz	100Hz
	0.1 Sec	1.00000	MHz	10Hz
	1 Sec	1.00000	MHz	10Hz
	10 Sec	000.000	kHz, OVER	1Hz
10MHz	0.01 Sec	10.0000	MHz	100Hz
	0.1 Sec	0.00000	MHz, OVER	10Hz
	1 Sec	0.00000	MHz, OVER	10Hz
	10 Sec	000.000	kHz, OVER	1Hz
100M Hz	0.01 Sec	100.000	MHz	1kHz
	0.1 Sec	00.0000	MHz, OVER	100Hz
	1 Sec	0.00000	MHz, OVER	10Hz
	10 Sec	000.000	kHz, OVER	1Hz

**Note:** When **OVER** LED is light on, The means that there are still more values than 6 digits on the Display. User can set more high Gate time to check it.

#### ❖ Example of the External Counter

To set the following conditions:

- ♦ Counter mode: External.

Procedure:

- 1 Press **SHIFT** **GATE** to select External source for Counter mode.
- 2 Connect the testing signal with "Counter Input BNC connector".
- 3 Press **GATE** to select the Gate time of you need.
- 4 The correct frequency will be displayed. (Parameter display Area (A))

## 6.16 THE VCF Function

The GFG-3015 also provides the function of Voltage control frequency (VCF). Input a voltage from 0 to 10V to the instrument can change the main output frequency. In other word, put a different input voltage will get a different main frequency.

Basically, If user put a voltage that from 0 to 10V to instrument then the variation of main frequency will over 100 times. But that just appear in Same “Frequency variation Range”. Because whole frequency range (0.01Hz ~ 15MHz) of GFG-3015 is composed of 8 frequency range (The detail is as below). So User’s voltage just can control at same frequency range.

For example, User can’t make the main frequency to 10kHz on range 7 by VCF input voltage. It must change to range 6 or 5.

Number of Range	Setting Frequency Range	VCF Frequency variation Range
8	1.5001MHz~15.0000MHz	150kHz~15MHz
7	150.01kHz~1.50000MHz	15kHz~1.5MHz
6	15.001kHz~150.000kHz	1.5kHz~150kHz
5	1.5001kHz~15.0000kHz	150Hz~15kHz
4	150.01Hz~1.50000kHz	15Hz~1.5kHz
3	15.01Hz~150.00Hz	1.5Hz~150Hz
2	1.51Hz~15.00Hz	0.15Hz~15Hz
1	0.01Hz~1.50Hz	0.01Hz~1.5Hz

The input voltage must be input with VCF BNC connector. If need to change “**The frequency variation range**”, proceed 6.3 The Setup of Frequency to modify the main setting frequency.

### ❖ Example of the Setup of VCF



To set the following conditions:

- ◆ Main function: Sine Wave.
- ◆ Main Output Amplitude: 10Vpp.
- ◆ Hope that Main output will output 10kHz on External VCF function.

Procedure:

- ① Press **FUNC** to select SINE wave for main output.
- ② Press **AMPL** **1** **0** **Hz/Vpp** in sequence.
- ③ Then press **FREQ** **1** **5** **0** **KHz/Vrms** in sequence to choose suitable main output frequency for corresponding “**VCF Frequency variation Range**”.
- ④ Input about DC 9V to “VCF input BNC connector”.
- ⑤ You will get about 10kHz sine signal from Main Output connector.  
Also, you can get 10kHz from VCF frequency variation range with the same procedure as above description by setting different value of input VCF voltage.

Please refer to the following:

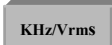
- 1) Press     in sequence to choose suitable main output frequency for corresponding “VCF Frequency variation Range”.
- 2) Input about **DC 3.3V** to “VCF input BNC connector”.
- 3) You will get about 10kHz Sine signal from Main Output connector.

**Note:** 1. It won't make any change on execution and result by taking different step sequence.  
 2. If need to change difference frequency variation range in order to get maximum variation (more than 100 times) at the same range, it is to be suggested to set the main frequency on the top of each frequency range.

## 6.17 THE GCV Output Function

The GFG-3015 provides the function of Generate control Voltage (GCV). User can get a voltage from 0.2V to 2V from the instrument and the voltage changes following the different main output frequency setting. In other words, if change the setting of the main frequency, the voltage got from GCV output BNC connector will be changed.

Basically, If user set any main frequency then It will get a relative voltage from instrument. But that just appear in same “Frequency Range”. Because whole frequency range (0.01Hz ~ 15MHz) of GFG-3015 are composed of 8 frequency range (The detail is as below). So the GCV output voltage (0.2 to 2V) just appear on each same frequency range.

Setting Frequency Range	GCV Output Voltage
15.0000MHz ~ 1.5001MHz	2 ~ 0.2V
1.50000MHz ~ 150.01kHz	2 ~ 0.2V
150.000kHz ~ 15.001kHz	2 ~ 0.2V
15.0000kHz ~ 1.5001kHz	2 ~ 0.2V
1.50000kHz ~ 150.01Hz	2 ~ 0.2V
150.00Hz ~ 15.01Hz	2 ~ 0.2V
15.00Hz ~ 1.51Hz	2 ~ 0.2V
1.50Hz ~ 0.01Hz	2 ~ 0.2V

### ❖ Example of the Setup of GCV

To set the following conditions:

- ♦ Get 2V from GCV output BNC connector.

Procedure:

- ❶ Press      in sequence.
- ❷ You will get about 2V from GCV output BNC connector.

Also, you can get 2V from another frequency ranges with the same procedure as above description by setting different frequency value.

Please refer to the following:

- 1) Press     in sequence.

2) You will get about 2V from GCV output BNC connector.

**Note:** It won't make any change on execution and result by taking different step sequence.

## 6.18 THE TTL Signal Output Function

The GFG-3015 provides a compatible TTL level signal from TTL Output BNC connector. The frequency of TTL signal output depends on the main output frequency. If need to modify the frequency of the signal, please refer to the procedure of 6.3 The Setup of Frequency.

The amplitude of the signal is fixed at  $\geq 3V_{pp}$  which can not be changed.

### ❖ *Example of the Setup of TTL Output*

To set the following conditions:

- ♦ Main Frequency: 5kHz.
- ♦ Signal Type: TTL Level.

Procedure:

- ❶ Set the main frequency to 5kHz(refer to 6.3 The Setup of Frequency).
- ❷ Connect with "TTL output BNC connector".
- ❸ You will get a 5kHz/TTL Level signal from the connector.

## 6.19 THE SYNC Signal Output Function

The GFG-3015 provides a synchronous signal with main output from SYNC Output BNC connector. The frequency of SYNC signal output synchronizes with main output. If need to modify the frequency of the signal, please refer to the procedure of 6.3 The Setup of Frequency.

The amplitude of the signal is fixed at  $>1V_{p-p}$  open circuit which can not be changed.

### ❖ *Example of the Setup of Sync Output*

To set the following conditions:

- ♦ Main Frequency: 10kHz.
- ♦ Signal Type: Synchronize with main output.

Procedure:

- ❶ Set the main frequency to 10kHz(refer to 6.3 The Setup of Frequency).
- ❷ Connect with "SYNC output BNC connector".
- ❸ You will get a 10kHz signal synchronized with main output from the connector.

## 6.20 Remote Control - RS232 Interface

The GFG3015 contains a DB 9-pin, male RS-232 connector for serial communication with a computer or terminal. The GFG-3015's RS-232 interface is configured as an RS-232 "Data Terminal Equipment" so that data is sent from pin 3 and received on pin 2. For remote controls, the RS-232 interface has to be connected with a computer or terminal.

## ❖ Pin Assignments

The Pin assignments of the RS232 connector on the rear panel for DB-9-D. The details are listed below.

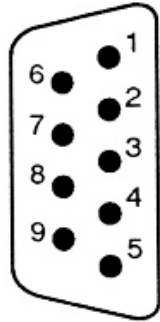

- 1 No connection
- 2 Receive Data (RxD) (input)
- 3 Transmit Data (TxD) (output)
- 4 No connection
- 5 Signal Ground (GND)
- 6 No connection
- 7 No connection
- 8 No connection
- 9 No connection

## ❖ DB9 to DB9 Wiring

The wiring configuration is used for computer with DB9 connectors that configured as Data Terminal Equipment.

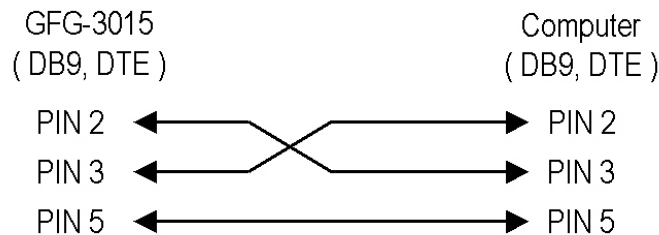

Figure 6.20.1 DB9 to DB9 wiring

When the GFG-3015 is set up with a RS232 interface, please check the following points:

- Do not connect the output line of one DTE device to the output line of the other.
- Many devices require a constant high signal on one or more input pins.
- Ensure that the signal ground of the equipment is connected to the signal ground of the external device.
- Ensure that the chassis ground of the equipment is connected to the chassis ground of the external device.
- Do not use more than 15m of cable to connect devices to a PC.
- Ensure the same configurations are used on the device as the one used on PC terminal.
- Ensure the connector for the both side of cable and the internal connected line are met the demand of the instrument.

## ❖ Communication Mode

The same baud rate and data format must be set to the instrument and the computer.

The baud rate of the RS-232 interface can be set as listed in the following table.

300 Baud	600 Baud	1200 Baud
2400 Baud	4800 Baud	9600 Baud
19200 Baud		

The data transmission format is N-8-1 (no parity bit, 8 data bits, 1 stop bits).

#### ❖ Computer's Connection

A personal computer with a COM port is the essential facility in order to operate the instruction via RS232 interface.

The connections between GFG-3015 and computer are as follows:

- Connect one end of a RS232 cable to the computer.
- Connect the other end of the cable to the RS232 port on the GFG-3015.
- Turn on the GFG-3015.
- Turn on the computer.

#### ❖ The RS232 connection testing

If you want to test whether the RS232 connection is working or not, you can send a command from computer. For instance, using a terminal program send the query command (uppercase)

\*IDN?

Should return the Manufacturer, model number and firmware version in the following format:

GW,GFG3015,V.1.00

If you do not receive a proper response from the GFG-3015, please check if the power is on, the RS232 configurations are the same on both sides, and all cable connections are active.

## 6.21 Commands Syntax

If you want to transfer any of the instructions to an instrument, there are three basic elements must be included.

- **Command header**
- **Parameter (if required)**
- **Message terminator or separator**

#### ❖ Command Header

The command header has a hierarchical structure that can be represented by a command tree.



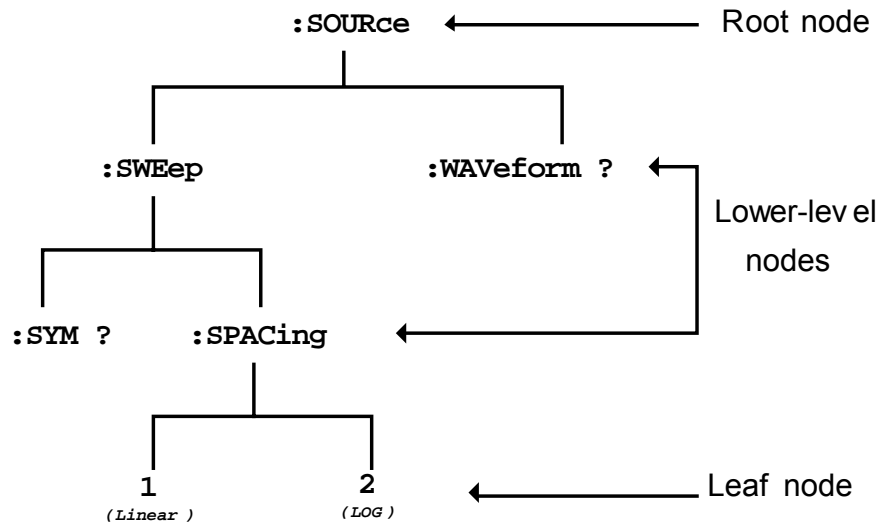

The top level of the tree is the root level. A root node is located at the root level. A root node and one or more lower-level nodes form a header path to the last node called the leaf node. The command header is configured by header path and leaf node. The below Figure shows the command header for the leaf node indicated.

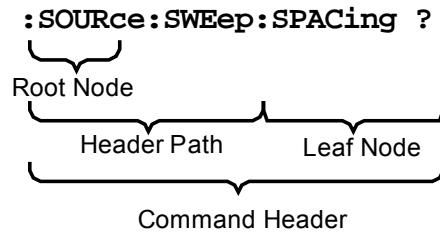

### ❖ Parameter

If the command has parameters, the values have to be included. In this manual, when we express the syntax of the command, the < > symbols are used for enclosing the parameter type. For instance, the syntax of the command in the following Figure includes the Boolean parameter type

**NOTE:** Do not include the <, >, or | symbols when entering the actual value for a parameter.



**Command Header with Parameter**

The following Table defines the Boolean and other parameter types for the GFG-3015.

Parameter Type	Description	Example
Boolean	Boolean numbers or values	1 0
NR1	Integers	0, 1, 18
NR2	Decimal numbers	1.5, 3.141, 8.4
NR3	Floating point numbers	4.5E-1, 8.25E+1
NRf	NR1, NR2, or NR3	1, 1.5, 4.5E-1

### Parameter Types for Syntax Descriptions

For the actual value of the parameter type <Boolean>, you have to enter 0 instead of "OFF" or enter 1 instead of "ON".

The following example includes both the header and a value for the parameter type:

```
:SOURce:TRIGger:STATe 0
```

The parameter values which appear in this manual are often separated by a vertical line. This vertical line means the word "or". For example, values for the parameter <Boolean> are

```
0|1
```

This means "0 (off) or 1 (on)", any single value is a valid parameter.

#### ❖ Message Terminator

As there is no signal of end message on RS232 bus, therefore use **LF** (Line Feed, 0x0A, or ASCII '\n') as message of terminator. When a series of commands are sent to the instrument, they must add a LF to be a judgment for message terminator. As for query command, the return message of the instrument is also added a LF for PC to judge message terminator.

#### ❖ Entering Commands

The standard, which governs the commands setting for the GFG-3015, is allowed a certain amount of flexibility when you enter commands. For instance, you can abbreviate many commands or combine commands into one message to send to the GFG-3015. This flexibility, called friendly listening, saves programming time and makes the command setting easier to be remembered and used.

#### ❖ Command Characters

The GFG-3015 is not sensitive to the command characters. You can enter commands in either uppercase or lowercase.

You can precede any command with white space characters. You must, however, use at least one space between the parameter and the command header.

## ❖ Abbreviating Commands

Most commands have both long form and short form. The list for each command in this section shows the abbreviations in upper case. For instance, you can enter the query

:SOURce:TRIGger:STATe ?

simply as:

:SOUR:TRIG:STAT ?

## 6.22 The Commands of RS-232 Serial Interface

### ❖ Common commands

Command	Function	Parameter	Arguments
*CLS	Clear status command		None
*IDN?	Identification query		None
*RCL	Recall command	<NR1>	<0~9>
*SAV	Save command	<NR1>	<0-9>
*RST	Default setting		

### ❖ Commands of the instrument

Command	Function	Parameter	Arguments
:SYSTem:ERR ?	Check the type of error messages		None
:FUNCTion:WAVEform	Set the waveform of main frequency	<NR1>	<1>Sinusoid <2>Triangle <3>Square
:FUNCTion:WAVEform ?	Check the present waveform of main frequency		None
:FREQuency	Set the main frequency	<NRf>	Numeric data
:FREQuency ?	Check the main frequency		None
:AMPLitude:VOLTage	Set the value of output amplitude	<NRf>	Numeric data
:AMPLitude:VOLTage ?	Check the value of output amplitude		None
:AMPLitude:UNIT	Set the unit of amplitude	<NR1>	<1>Vpp <2>Vrms <3>dBm
:AMPLitude:UNIT ?	Check the unit of amplitude		None
:OFFSet	Set the voltage of offset	<NRf>	Numeric data
:OFFSet ?	Check the voltage of offset		None
:DUTY	Set the value of duty	<NR1>	Numeric data
:DUTY ?	Check the value of duty		None
:SOURce:WAVEform	Set the waveform of modulation mode	<NR1>	<1>Sinusoid <2>Triangle <3>Square

Command	Function	Parameter	Arguments
:SOURce:WAVeform ?	Check the present waveform of modulation mode		None
:SOURce:STATe	Set the modulation function	<NR1>	<0>OFF <1>AM <2>FM <3>Sweep
:SOURce:STATe ?	Check the modulation function		None
:SOURce:SOURce	Set the modulation source	<NR1>	<0>Internal <1>External
:SOURce:SOURce ?	Check the modulation source		None
:SOURce:MODAM:RATE	Set the value of AM Rate	<NRf>	Numeric data
:SOURce:MODAM:RATE ?	Check the value of AM Rate		None
:SOURce:MODAM:SPAN	Set the value of AM span	<NR1>	Numeric data
:SOURce:MODAM:SPAN ?	Check the value of AM span		None
:SOURce:MODAM:SYM	Set the value of AM SYM	<NR1>	Numeric data
:SOURce:MODAM:SYM ?	Check the value of AM SYM		None
:SOURce:MODFM:RATE	Set the value of FM Rate	<NRf>	Numeric data
:SOURce:MODFM:RATE ?	Check the value of FM Rate		None
:SOURce:MODFM:SPAN	Set the value of FM span	<NR1>	Numeric data
:SOURce:MODFM:SPAN ?	Check the value of FM span		None
:SOURce:MODFM:SYM	Set the value of FM SYM	<NR1>	Numeric data
:SOURce:MODFM:SYM ?	Check the value of FM SYM		None
:SOURce:SWEep:START	Set the value of sweep start frequency	<NRf>	Numeric data
:SOURce:SWEep:START ?	Check the value of sweep start frequency		None
:SOURce:SWEep:STOP	Set the value of sweep stop frequency	<NRf>	Numeric data
:SOURce:SWEep:STOP ?	Check the value of sweep stop frequency		None
:SOURce:SWEep:CENTer	Set the value of sweep center frequency	<NRf>	Numeric data
:SOURce:SWEep:CENTer ?	Check the value of sweep center frequency		None
:SOURce:SWEep:SPAN	Set the value of sweep span	<NRf>	Numeric data
:SOURce:SWEep:SPAN ?	Check the value of sweep span		None
:SOURce:SWEep:RATE	Set the value of sweep rate	<NRf>	Numeric data
:SOURce:SWEep:RATE ?	Check the value of sweep rate		None
:SOURce:SWEep:SYM	Set the value of sweep SYM	<NR1>	Numeric data
:SOURce:SWEep:SYM ?	Check the value of sweep SYM		None

Command	Function	Parameter	Arguments
:SOURce:SWEep:SPACing	Set the method of sweep	<NR1>	<0>Linear <1>LOG
:SOURce:SWEep:SPACing ?	Check the method of sweep		None
:SOURce:TRIGger:RATE	Set the value of trigger rate	<NRf>	Numeric data
:SOURce:TRIGger:RATE ?	Check the value of trigger rate		None
:SOURce:TRIGger:STATE	Set the trigger state	<NR1>	<1>ON <0>OFF
:SOURce:TRIGger:STATE ?	Check the trigger state		None
:SOURce:TRIGger:PHASe	Set the value of trigger phase	<NR1>	Numeric data
:SOURce:TRIGger:PHASe ?	Check the value of trigger phase		None
:SOURce:TRIGger:MODE	Set the trigger mode	<NR1>	<0>Single <1>Mutiple
:SOURce:TRIGger:MODE ?	Check the trigger mode		None
:SOURce:TRIGger:SOURce	Set the trigger source	<NR1>	<0> Internal <1> External
:SOURce:TRIGger:SOURce ?	Check the trigger source		None
:SOURce:TRIGger:SYM	Set the value of trigger SYM	<NR1>	Numeric data
:SOURce:TRIGger:SYM ?	Check the value of trigger SYM		None
:SOURce:COUNter:GATE	Set the gate time of counter	<NR1>	<0>001sec <1>01sec <2>1sec <3>10sec
:SOURce:COUNter:GATE ?	Check the gate time of counter		None
:SOURce:COUNter:SOURce	Set the counter source	<NR1>	<0> Internal <1> External
:SOURce:COUNter:SOURce ?	Check the counter source		

## ❖ Error Messages

### ● Command Error

Error Code	SCPI Error Code / Explanation
-100	Command error
-102	Syntax error

### ● Execution Error

Error Code	SCPI Error Code / Explanation
-220	Parameter error
-221	Settings conflict
-222	Data out of range

## 6.23 The Examples of the Communication Interface Software

```
/*
*****
* Microsoft Visual C++ 6.0 for RS-232
*
* This programming example shows how to communicate
* PC and instrument via RS232.
*
*   "*IDN?\n"           : Ask the Manufacturer, model number
*                       and firmware
*   " :FREQUENCY 1000.0\n" : Set Frequency=1000Hz
*
*****
*/

#include <stdio.h>
#include <windows.h>

HANDLE InitCom (int Error_Value);

char *Error_Message[6]={
    "Error Create File\n",
    "Error SetCommTimeouts\n",
    "Error SetCommState\n",
    "Error SetupComm\n",
    "Error GetCommState\n",
    "Error EscapeCommFunction\n"
};

void main()
{
    char          command_line[100];
    char          Receive_Data[100];
    char          Read_Machine_Number[10] = {"*IDN?\n"};
    DWORD        dwcommand_len=0,dwWritten=0,dwRead=0;
    int          i,error_value=0;
    HANDLE       hComm;
```

```

/*----- initial Data -----*/
for(i = 0; i<100;i++) command_line[i]=0;
for(i = 0; i<100;i++) Receive_Data[i]=0;

/*----- Create Comm_port -----*/
hComm = InitCom(error_value);

/*----- Send *IDN? -----*/

dwcommand_len =sprintf( command_line,"*IDN?\n"); // '\n' is message
// terminator
WriteFile(hComm,command_line,dwcommand_len,&dwWritten,NULL);

Sleep(1000); // delay 1 sec for instrument response

ReadFile(hComm,Receive_Data,100,&dwRead,NULL);

Receive_Data[strlen(Receive_Data)] = 0x00;
printf("\nReceive_Data = %s\n",Receive_Data);

/*----- Send FRQuency = 1000Hz -----*/

dwcommand_len =sprintf( command_line,":FREQuency %3.0f\n",1000.0);
// '\n' is message terminator
WriteFile(hComm,command_line,dwcommand_len,&dwWritten,NULL);

CloseHandle(hComm);
}

/*-----*/
/*          Initial RS-232          */
/*-----*/
HANDLE InitCom(int Error_Value)
{
    HANDLE          hComm;
    COMMTIMEOUTS   CommTimeOuts;

    hComm = CreateFile("COM1",
        GENERIC_READ | GENERIC_WRITE, 0, NULL, OPEN_EXISTING,NULL, NULL );

    if (hComm == INVALID_HANDLE_VALUE)
    {
        printf("%s",Error_Message[0]);
        return FALSE;
    }

    /*----- Timeout -----*/
    CommTimeOuts.ReadIntervalTimeout = 1;
    CommTimeOuts.ReadTotalTimeoutMultiplier = 0;
    CommTimeOuts.ReadTotalTimeoutConstant = 1000;
    CommTimeOuts.WriteTotalTimeoutMultiplier = 0;
    CommTimeOuts.WriteTotalTimeoutConstant = 5000;
    if(!SetCommTimeouts(hComm, &CommTimeOuts ))
    {
        printf("%s",Error_Message[1]);
        return FALSE;
    }
}

```

```

/*-----*/
/*          set baud rate          */
/*          ByteSize                */
/*          parity                  */
/*          StopBits                */
/*-----*/

DCB dcb = {0};

dcb.DCBlength = sizeof(dcb);
if (!GetCommState(hComm, &dcb))
{
    printf("%s",Error_Message[2]);
    return FALSE;
}

dcb.BaudRate = CBR_9600; // current baud rate
dcb.ByteSize = 8;       // number of bits/byte, 4-8
dcb.Parity = 0;        // 0-4=no,odd,even,mark,space
dcb.StopBits=0;        // 0,1,2 = 1, 1.5, 2

if (!SetCommState(hComm, &dcb))
{
    printf("%s",Error_Message[3]);
    return FALSE;
}

/*----- Set In,Out Queue -----*/
if(!SetupComm(hComm, 8196,8196))
{
    printf("%s",Error_Message[4]);
    return FALSE;
}

if (!EscapeCommFunction(hComm, SETDTR))
{
    printf("%s",Error_Message[5]);
    return FALSE;
}

return hComm;
}

```



## 6.24 The Error message of instrument

The operation of GFG-3015 is a whole digitizing operation user interface. Every parameter will be showing by numerically and every input value keyed in with numerical keys. So when key in the value to instrument, it might cause some mistake, now the GFG-3015 will show a corresponding error code on the Display a few seconds later for User to correct the data. (Please refer to the specification or Operation ways). The detailed explanation is as following table:

Error Code	Explanation
E01	Frequency over range
E02	Frequency over Resolution
E03	Amplitude over range
E04	Amplitude over resolution
E05	Offset over range
E06	Offset over resolution
E07	Duty over range
E08	Duty over resolution
E09	Mod rate over range
E10	Mod rate over resolution
E11	Mod sym over range
E12	Mod sym over resolution
E13	Sweep freq over range
E14	Sweep freq over resolution
E15	AM span over range
E16	AM span over resolution
E17	FM span over range
E18	FM span over resolution
E19	Trigger phase over range
E20	Trigger phase resolution
E21	Store setting over settng numbers range
E22	Recall setting over settng numbers range
E23	Recall set is no data









## 7. Adjustment and Correction

### 7.1 Preparation

- ❶ The essential equipment listed as follows:

Instrument	Critical Specification
Oscilloscope	Over 100MHz Bandwidth
Counter	Over 200MHz Test Frequency Range. The Frequency Resolution must cover GFG-3015.
AC/DC Voltmeter	4 1/2 Digit DC accuracy
Distortion Meter (or Audio Analyzer)	Over 10Hz to 100kHz Test Range.
DC power supply	Over 20V/0.5A Supply
RF Signal Generator	Over 150MHz Output Frequency Range, The Frequency Accuracy must cover GFG-3015.
Signal Generator	Lower 5 Hz Output Frequency Range. The Frequency Accuracy must cover GFG-3015
RF Spectrum Analyzer	Over 100MHz Bandwidth, Amplitude: $\pm 0.5\text{dB}$
50 $\Omega$ Terminator	50 $\Omega \pm 0.2\%$ , 1W

- ❷ The warm-up time of the instrument should be more than 30 minutes.  
 ❸ The operation temperature should be at  $23 \pm 5^\circ\text{C}$ , and the humidity should be lower than PH80%.  
 ❹ Calling “System Default Calibration Data”. The detail as following:

Press        in sequence, all the LEDs (Except GATE and OVER) will light up, then press  key again, all calibration values will be cleared. So **don't make a rash decision to do it.**

- ↪ After proceed the step, all calibration values will be lost and the “default setting” will be recalled.

### 7.2 Adjust and Check up the operation DC Voltage







- ❶ Set the DMM to DCV range to measure the particular test point.  
 ❷ Adjust the adjust points and check up the operation DC voltage according to the following table:

Test Point	Adjust Point	Correct Voltage Value
TP122	SVR120	$18\text{V} \pm 0.01\text{V}$
TP124	SVR121	$-18\text{V} \pm 0.01\text{V}$
TP131	CHECK	$15\text{V} \pm 0.75\text{V}$
TP141	CHECK	$-15\text{V} \pm 0.75\text{V}$
TP112	CHECK	$5\text{V} \pm 0.25\text{V}$
TP150	CHECK	$5\text{V} \pm 0.25\text{V}$
U921 PIN1	CHECK	$-5\text{V} \pm 0.25\text{V}$







- ③ Now, the “ASP 2” is shown on the up side display and the “2450” is shown on the down side display. Set the oscilloscope to 2V/DIV, 0.2mS/DIV and 50Ω load to measure the main output. Input suitable Calibration values to set the Amplitude to 10Vpp, then press  to finish the step and proceed next step(ASP 3).
- ④ Now, the “ASP 3” is shown on the up side display and the “2390” is shown on the down side display. Set the oscilloscope to 2V/DIV, 0.2mS/DIV and 50Ω load to measure the main output. Input suitable Calibration values to set the span of modulation to 100%, then press  to finish the step and proceed next step(ASP 4).
- ⑤ Now, the “ASP 4” is shown on the up side display and the “2460” is shown on the down side display. Set the oscilloscope to 2V/DIV, 0.2mS/DIV and 50Ω load to measure the main output. Input suitable Calibration values to set the Amplitude to 10Vpp, then press  to finish the step and proceed next step (ASP 5).
- ⑥ Now, the “ASP 5” is shown on the up side display and the “2280” is shown on the down side display. Set the oscilloscope to 2V/DIV, 0.2mS/DIV and 50Ω load to measure the main output. Input suitable Calibration values to set the span of modulation to 100%, then press  to finish the step and proceed next step(ASP 6).
- ⑦ Now, the “ASP 6” is shown on the up side display and the “2610” is shown on the down side display. Set the oscilloscope to 2V/DIV, 0.2mS/DIV and 50Ω load to measure the main output. Input suitable Calibration values to set the Amplitude to 100%, then press  to finish the step and proceed next step(ASP 7).
- ⑧ Now, the “ASP 7” is shown on the up side display and the “2040” is shown on the down side display. Set the DMM to DCV range and 50 Ω load to measure the main output. Input suitable Calibration values to set the DC offset to 0.000V, then press  to finish the step and the instrument will be back to original state.

### 7.10.3 Check the Modulation Bandwidth

- ① Set Conditions:
 

Function : Sine Wave	Amplitude : 10Vp-p
Duty Cycle : 50%	Frequency : 100kHz
Modulation Source : Sine	Modulation Type : AM
SYM : 50%	RATE : 1kHz
Span : 100%	Modulation : ON
- ② Set the oscilloscope to 1V/DIV, 0.2ms/DIV and 50 Ω load to measure the main output. Then fine adjusting the vertical scale of oscilloscope until the amplitude is full of 8 divisions.

- ③ Set Conditions: Frequency : 5MHz
- ④ The Amplitude of waveform must be over 6 divisions.

#### 7.10.4 Check the Modulation Output

- ① Set Conditions:
 

Function : Sine Wave	Amplitude : 10Vp-p
Duty Cycle : 50%	Frequency : 100kHz
Modulation Source : Sine	Modulation Type : AM
SYM : 50%	RATE : 1kHz
Span : 100%	Modulation : ON
- ② Set the oscilloscope to 1V/DIV, 0.5ms/DIV to measure the “MOD Output BNC”.
- ③ The BNC connector will output 1kHz sine wave and the amplitude must be  $\geq 1V_{pp}$ .







#### 7.10.5 Check the External Modulation input function

- ① Set Conditions:
 

Function : Sine Wave	Amplitude : 10Vp-p
Duty Cycle : 50%	Frequency : 5MHz
Signal Source : Exit	Modulation Type : AM
Modulation : ON	
- ② Input a 10Vpp/100kHz Sine wave to “EXT Modulation/Trigger Input BNC”.
- ③ Set the oscilloscope to 2V/DIV, 2us/DIV and 50Ω load to measure the main output.
- ④ The Span of AM modulation must be  $\geq 100\%$  now.
- ⑤ Input another signal from 10Vpp/10Hz to 1MHz Sine wave to “EXT Modulation /Trigger Input BNC” and check the Span which must be  $\geq 100\%$ .

### 7.11 Adjusting FM and Sweep Function

#### 7.11.1 Adjusting the Span of FM







- ① Press        in sequence, the “CaL...” will be shown on the display A (Parameter display Area (A)), and the “FSP” will be shown on the display B (Parameter display Area (B)). Now, the GFG-3015 is in calibration state.
- ② Wait about 5 minutes, the instrument will be back to original state. That means the calibration is completed.
- ③ Set Conditions:
 

Function : Sine Wave	Amplitude : 10Vp-p
Duty Cycle : 50%	Frequency : 100kHz
Signal Source : Sine	Modulation Type : FM
Span : 15%	Modulation : ON
- ④ Set the oscilloscope to 2V/DIV, 1us/DIV and 50 Ω load to measure the main output.
- ⑤ The Span of FM modulation must be  $\geq 15\%$  now.  
 The maximum frequency must be  $\geq 115kHz$   
 The minimum frequency must be  $\leq 85kHz$

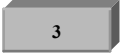
### 7.11.2 Adjusting the LOG sweep

- 1 Set Conditions:  
Function : Sine Wave      Amplitude : 10Vp-p  
Duty Cycle : 50%      Frequency : 10kHz  
Sweep Type : LIN      Start Frequency : 150Hz  
Stop Frequency : 15kHz      RATE : 10kHz  
Modulation : ON
- 2 Set the oscilloscope to 5V/DIV, 20us/DIV to measure the “MOD Output BNC”.
- 3 Record the positive peak level value of the waveform
- 4 Change the Sweep type from LIN to LOG.
- 5 Adjust VR720 until the positive peak level value reaches the same level as step 3.
- 6 Check the amplitude which must be over 10Vpp.

### 7.11.3 Adjusting the Span of Sweep

- 1 Press        in sequence, the “CaL...” will be shown on the display A (Parameter display Area (A), the “LIN” or “LOG” will be on the display B (Parameter display Area (B)). Now, the GFG-3015 is in calibration state.
- 2 Wait about 5 minutes, the instrument will be back to original state. That means the calibration is completed.

### 7.11.4 Check the Modulation Output

- 1 Set Conditions:  
Function : Sine Wave      Amplitude : 10Vp-p  
Duty Cycle : 50%      Frequency : 100kHz  
Modulation Source : Sine      Modulation Type : FM  
SYM : 50%      RATE : 1kHz  
Span : 15%      Modulation : ON
- 2 Set an oscilloscope to 1V/DIV, 0.5ms/DIV to measure the “MOD Output BNC”.
- 3 The BNC connector will output 1kHz sine wave and the amplitude must be  $\geq 1V_{pp}$ .
- 4 Set Conditions:  
Sweep Type : LIN      Start Frequency : 150Hz  
Stop Frequency : 15kHz      RATE : 1kHz  
Modulation : ON
- 5 The BNC connector will output 1kHz Ramp wave and the amplitude must be  $\geq 5V_{pp}$  into 10k  $\Omega$ .

### 7.11.5 Check the External Modulation input function

- 1 Set Conditions:  
Function : Sine Wave      Amplitude : 10Vp-p  
Duty Cycle : 50%      Frequency : 100kHz  
Signal Source : Exit      Modulation Type : FM  
Modulation : ON
- 2 Input a 5Vpp/20kHz Sine wave to “EXT Modulation/Trigger Input BNC”.
- 3 Set the oscilloscope to 2V/DIV, 1us/DIV and 50  $\Omega$  load to measure the main output.
- 4 The Span of FM modulation must be  $\geq 15\%$  now.  
The maximum frequency must be  $\geq 115kHz$ .  
The minimum frequency must be  $\leq 85kHz$ .



## 7.12 Adjusting Trigger Phase

### 7.12.1 Adjusting the Trigger Phase

- 1 Press **SHIFT** **3** **0** **1** **5** **6** **HOLD** in sequence, the “trg 0” will be shown on the up side display (Parameter display Area (A)), and the “3190” will be shown on the down side display (Parameter display Area (B)). The Down side figures are the corresponding Calibration values that can use all numeric keys and use any unit keys to complete the entry mode. Besides, you can use **◀** **▶** and the Rotate Knob to modify the value you need.
- 2 Set the oscilloscope to 1V/DIV, 0.2ms/DIV to measure the main output, and fine adjusting the vertical scale of the oscilloscope until the amplitude is full of 8 divisions. Then input suitable Calibration values to set the trigger phase to 0° (at 4 division), and press **HOLD** finish the step and proceed next step(trg -90° ).
- 3 Now, the “trg -90° ” is shown on the up side display and the “3700” is shown on the down side display. Then input suitable Calibration values to set the trigger phase to -90° (at negative peak), and press **HOLD** to finish the step and proceed next step(trg 80° ).
- 4 Now, the “trg 80° ”is shown on the up side display and the “2700” is shown on the down side display now. Then input the suitable Calibration Value to make the trigger phase on **80° (at 7.6 division)**. Then press **HOLD** to finish this step and into next step(trg 45° ).
- 5 Now, the “trg 45° ”is shown on the up side display and the “2920” is shown on the down side display now. Then input the suitable Calibration Value to make the trigger phase on **45° (at 6 division)**. Then press **HOLD** finished this step and into next step(trg -45° ).
- 6 Now, the “trg -45° ”is shown on the up side display and the “3450” is shown on the down side display now. Then input the suitable Calibration Value to make the trigger phase on **-45° (at 2 division)**. Then press **HOLD** to finish this step. The instrument will back to Original states after press this key now.

### 7.12.2 Check the External Trigger input function







- 1 Set Conditions:

Function : Sine Wave	Amplitude : 10Vp-p
Duty Cycle : 50%	Frequency : 5kHz
Trigger Source : Exit	Trigger type: Single-trigger
Trigger Phase: 30°	Trigger : ON
- 2 Input a 1kHz/TTL level signal to “EXT Modulation/Trigger Input BNC”.
- 3 Set the oscilloscope to 2V/DIV, 0.2ms/DIV and 50Ω load to measure the main output.
- 4 The main output is the same as Figure (1) now (refer to 6.13 Setup of Trigger).

## 7.13 Calibrating by Software

### Manual Calibration

Basic Steps introduction :

① Press        in sequence to set to the manual calibration mode.



↪ The “001” will be shown on the “Parameter display Area (A)” and the “2000” will be shown on the “Parameter display Area (B)”.

The figures on the up side display (Parameter display Area (A)) represent the Calibration Number, and the down side display (Parameter display Area (B)) figures are the corresponding Calibration Value.

↪ Press  key to select the setting mode between Calibration Number and Calibration Value alternately.

When  LED is lighted up, you can input or modify the Calibration Number as you wish.





When  LED is lighted up, you can input or modify the Calibration Value as you wish.





② Key in the desired value by using all numeric keys and any unit keys to complete the entry mode. Besides, you can use   and the Rotate Knob to modify the value you need.

③ Press  key to finish the manual calibration mode, and all new Calibration Value will become effective.

### Example:

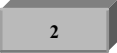
i.) When the “001” is shown on the up side display, the “2020” is shown on the down side display and the  LED is lighted up, that means the instrument is in the Calibration Number mode.

ii.) Press  key once, the  LED will be lighted up, now the instrument is set to the Calibration Value mode. Press  key again, the setting is shifted to calibration number mode and the  LED will be lighted up again.

ii.) Press    keys to set to the OFFSET Calibration mode, and the Calibration Value is 560. Press  key once, and  LED will light up. Just input the desired figures.

iii.) Press  key to finished the manual calibration mode. All new Calibration Value will become effective After press this key.

The table below lists the corresponding Calibration Numbers to Calibration items:

Calibration Item	Calibration Number
DC OFFSET Calibration	1 ~ 33
Attenuator Calibration of Sine	34 ~ 49
Attenuator Calibration of Triangle	50 ~ 65
Attenuator Calibration of Square	66 ~ 81
Amplitude Calibration 1 of Sine	82 ~ 141
Amplitude Calibration 2 of Sine	142 ~ 166
Amplitude Calibration 3 of Sine	167 ~ 179
Amplitude Calibration 1 of Triangle	180 ~ 239
Amplitude Calibration 2 of Triangle	240 ~ 264
Amplitude Calibration 3 of Triangle	265 ~ 277
Amplitude Calibration 1 of Square	278 ~ 337
Amplitude Calibration 2 of Square	338 ~ 362
Amplitude Calibration 3 of Square	363 ~ 375

The procedure of manual calibrating with software is as follows:

### 7.13.1 DC OFFSET Calibration (Calibration Number from 1 ~ 33)

*To calibrate the DC OFFSET. You should go through Calibration Number 1 ~ 33 in turn, and perform the following 3 steps for each number.*

- ❶ Set the Calibration Number.
- ❷ Set the DMM to DCV range and 50  $\Omega$  load to measure the main output.
- ❸ Key in an appropriate Calibration value to set the output to the specific value listed below:

Calibration Number	The output should be	Calibration Number	The output should be
1	0 $\pm$ 0.5mV	18	4.99V $\pm$ 5mV
2	4.99V $\pm$ 5mV	19	2.5V $\pm$ 5mV
3	2.5V $\pm$ 5mV	20	2.49V $\pm$ 5mV
4	2.49V $\pm$ 5mV	21	1.25V $\pm$ 5mV
5	1.25V $\pm$ 5mV	22	1.24V $\pm$ 5mV
6	1.24V $\pm$ 5mV	23	0.63V $\pm$ 5mV
7	0.63V $\pm$ 5mV	24	0.62V $\pm$ 5mV
8	0.62V $\pm$ 5mV	25	0.32V $\pm$ 0.5mV
9	0.32V $\pm$ 0.5mV	26	0.31V $\pm$ 0.5mV
10	0.31V $\pm$ 0.5mV	27	0.16V $\pm$ 0.5mV
11	0.16V $\pm$ 0.5mV	28	0.15V $\pm$ 0.5mV
12	0.15V $\pm$ 0.5mV	29	0.08V $\pm$ 0.5mV
13	0.08V $\pm$ 0.5mV	30	0.07V $\pm$ 0.5mV
14	0.07V $\pm$ 0.5mV	31	0.04V $\pm$ 0.5mV
15	0.04V $\pm$ 0.5mV	32	0.03V $\pm$ 0.5mV
16	0.03V $\pm$ 0.5mV	33	0.01V $\pm$ 0.5mV
17	0.01V $\pm$ 0.5mV		

### 7.13.2 Attenuator Calibration of Sine (Calibration Number from 34 ~ 49)

To calibrate the Attenuator for sine wave. You should go through Calibration Number 34 ~ 49 in turn, and perform the following 3 steps for each number.

- ❶ Set the Calibration Number.
- ❷ Set the oscilloscope to 50Ω load to measure the main output.
- ❸ Key in an appropriate Calibration Value to set the output to the specific value listed below:

Calibration Number	The output should be :	Calibration Number	The output should be :
34	10.08Vpp ~ 9.92Vpp	42	634mVpp ~ 626mVpp
35	5.08Vpp ~ 4.92Vpp	43	332mVpp ~ 328mVpp
36	5.08Vpp ~ 4.92Vpp	44	322mVpp ~ 318mVpp
37	2.52Vpp ~ 2.48Vpp	45	172mVpp ~ 168mVpp
38	2.52Vpp ~ 2.48Vpp	46	162mVpp ~ 158mVpp
39	1.264Vpp ~ 1.256Vpp	47	92mVpp ~ 88mVpp
40	1.256Vpp ~ 1.248Vpp	48	82mVpp ~ 78mVpp
41	644mVpp ~ 636mVpp	49	11mVpp ~ 9mVpp

### 7.13.3 Attenuator Calibration of Triangle (Calibration Number from 50 ~ 65)

To calibrate the Attenuator for triangle wave. You should go through Calibration Number 50 ~ 65 in turn, and perform the following 3 steps for each number.

- ❶ Set the Calibration Number.
- ❷ Set the oscilloscope to 50 Ω load to measure the main output.
- ❸ Key in an appropriate Calibration value to set the output to the specific value listed below:

Calibration Number	The output should be :	Calibration Number	The output should be :
50	10.08Vpp ~ 9.92Vpp	58	634mVpp ~ 626mVpp
51	5.08Vpp ~ 4.92Vpp	59	332mVpp ~ 328mVpp
52	5.08Vpp ~ 4.92Vpp	60	322mVpp ~ 318mVpp
53	2.52Vpp ~ 2.48Vpp	61	172mVpp ~ 168mVpp
54	2.52Vpp ~ 2.48Vpp	62	162mVpp ~ 158mVpp
55	1.264Vpp ~ 1.256Vpp	63	92mVpp ~ 88mVpp
56	1.256Vpp ~ 1.248Vpp	64	82mVpp ~ 78mVpp
57	644mVpp ~ 636mVpp	65	11mVpp ~ 9mVpp

### 7.13.4 Attenuator Calibration of Square (Calibration Number from 66 ~ 81)

To calibrate the Attenuator for square wave. You should go through Calibration Number 66 ~ 81 in turn, and perform the following 3 steps for each number.

- ❶ Set the Calibration Number.
- ❷ Set the oscilloscope to 50Ω load to measure the main output.
- ❸ Key in an appropriate Calibration value to set the output to the specific value listed below:

Calibration Number	The output should be	Calibration Number	The output should be
66	10.08Vpp ~ 9.92Vpp	74	634mVpp ~ 626mVpp
67	5.08Vpp ~ 4.92Vpp	75	332mVpp ~ 328mVpp
68	5.08Vpp ~ 4.92Vpp	76	322mVpp ~ 318mVpp
69	2.52Vpp ~ 2.48Vpp	77	172mVpp ~ 168mVpp
70	2.52Vpp ~ 2.48Vpp	78	162mVpp ~ 158mVpp
71	1.264Vpp ~ 1.256Vpp	79	92mVpp ~ 88mVpp
72	1.256Vpp ~ 1.248Vpp	80	82mVpp ~ 78mVpp
73	644mVpp ~ 636mVpp	81	11mVpp ~ 9mVpp

### 7.13.5 Amplitude Calibration 1 of Sine (Calibration Number from 82 ~ 141)

To calibrate the Amplitude for sine wave from 250kHz to 15MHz range. You should go through Calibration Number 82 ~ 141 in turn, and perform the following 3 steps for each number.

- ❶ Set the Calibration Number.
  - ❷ Set the oscilloscope to 50 Ω load to measure the main output.
  - ❸ Key in an appropriate Calibration value to set the output to 6.44Vpp ~ 6.56Vpp.
- ↪ Because each frequency has different frequency response of its own. Therefore, we must calibrate the amplitude for every frequency. In this calibration step, every 250kHz from 250kHz to 15MHz range have a Calibration point (Number).  
For example: The test frequency of Calibration Number 83 is at 500kHz, the other test Frequency of Calibration Number is X, then:

$$X = [(Calibration\ Number - 82) * 250kHz] + 250kHz$$

### 7.13.6 Amplitude Calibration 2 of Sine (Calibration Number from 142 ~ 166)

To calibrate the Amplitude for sine wave from 9MHz to 15MHz range. You should go through Calibration Number 142 ~ 166 in turn, and perform the following 3 steps for each number.

- ❶ Set the Calibration Number.
  - ❷ Set the oscilloscope to 50Ω load to measure the main output.
  - ❸ Key in an appropriate Calibration value to set the output to 8.62Vpp ~ 8.78Vpp.
- ↪ The same reason described as 7.13.5, so the formula for Test frequency as below :  
The test Frequency of Calibration Number is X, then:

$$X = [(Calibration\ Number - 142) * 250kHz] + 9MHz$$

### 7.13.7 Amplitude Calibration 3 of Sine (Calibration Number from 167 ~ 179)

To calibrate the Amplitude for sine wave from 12MHz to 15MHz range. You should go through Calibration Number 167 ~ 179 in turn, and perform the following 3 steps for each number.

- ❶ Set the Calibration Number.
- ❷ Set the oscilloscope to 50Ω load to measure the main output.
- ❸ Key in an appropriate Calibration value to set the output to 9.62Vpp ~ 9.78Vpp.

↪ The same reason described as 7.13.5, so the formula for Test frequency as below :

The test Frequency of Calibration Number is X, then:

$$X = [(Calibration\ Number - 167) * 250kHz] + 12MHz$$

#### 7.13.8 Amplitude Calibration 1 of Triangle (Calibration Number from 180 ~ 239)

*To calibrate the Amplitude for triangle wave from 250kHz to 15MHz range. You should go through Calibration Number 180 ~ 239 in turn, and perform the following 3 steps for each number.*

- ❶ Set the Calibration Number.
- ❷ Set the oscilloscope to 50Ω load to measure the main output.
- ❸ Key in an appropriate Calibration value to set the output to **6.44Vpp ~ 6.56Vpp**.

↪ The same reason described as 7.13.5, so the formula for Test frequency as below :

The test Frequency of Calibration Number is X, then:

$$X = [(Calibration\ Number - 180) * 250kHz] + 250kHz$$

#### 7.13.9 Amplitude Calibration 2 of Triangle (Calibration Number from 240 ~ 264)

*To calibrate the Amplitude for triangle wave from 9MHz to 15MHz range. You should go through Calibration Number 240 ~ 264 in turn, and perform the following 3 steps for each number.*

- ❶ Set the Calibration Number.
- ❷ Set the oscilloscope to 50Ω load to measure the main output.
- ❸ Key in an appropriate Calibration value to set the output to **8.62Vpp ~ 8.78Vpp**.

↪ The same reason described as 7.13.5, so the formula for Test frequency as below :

The test Frequency of Calibration Number is X, then:

$$X = [(Calibration\ Number - 240) * 250kHz] + 9MHz$$

#### 7.13.10 Amplitude Calibration 3 of Triangle (Calibration Number from 265 ~ 277)

*To calibrate the Amplitude for triangle wave from 12MHz to 15MHz range. You should go through Calibration Number 265 ~ 277 in turn, and perform the following 3 steps for each number.*

- ❶ Set the Calibration Number.
- ❷ Set the oscilloscope to 50Ω load to measure the main output.
- ❸ Key in an appropriate Calibration value to set the output to **9.62Vpp ~ 9.78Vpp**.

↪ The same reason described as 7.13.5, so the formula for Test frequency as below :

The test Frequency of Calibration Number is X, then:

$$X = [(Calibration\ Number - 265) * 250kHz] + 12MHz$$

### 7.13.11 Amplitude Calibration 1 of Square (Calibration Number from 278 ~ 337)

To calibrate the Amplitude for square wave from 250kHz to 15MHz range. You should go through Calibration Number 278 ~ 337 in turn, and perform the following 3 steps for each number.

- ❶ Set the Calibration Number.
  - ❷ Set the oscilloscope to 50Ω load to measure the main output.
  - ❸ Key in an appropriate Calibration value to set the output to 6.44Vpp ~ 6.56Vpp.
- ↪ The same reason described as 7.13.5, so the formula for Test frequency as below :

The test Frequency of Calibration Number is X, then:

$$X = [(Calibration\ Number - 278) * 250kHz] + 250kHz$$

### 7.13.12 Amplitude Calibration 2 of Square (Calibration Number from 338 ~ 362)

To calibrate the Amplitude for square wave from 9MHz to 15MHz range. You should go through Calibration Number 338 ~ 362 in turn, and perform the following 3 steps for each number.

- ❶ Set the Calibration Number.
  - ❷ Set the oscilloscope to 50Ω load to measure the main output.
  - ❸ Key in an appropriate Calibration value to set the output to 8.62Vpp ~ 8.78Vpp.
- ↪ The same reason described as 7.13.5, so the formula for Test frequency as below :

The test Frequency of Calibration Number is X, then:

$$X = [(Calibration\ Number - 338) * 250kHz] + 9MHz$$

### 7.13.13 Amplitude Calibration 3 of Square (Calibration Number from 363 ~ 375)

To calibrate the Amplitude for square wave from 12MHz to 15MHz range. You should go through Calibration Number 363 ~ 375 in turn, and perform the following 3 steps for each number.

- ❶ Set the Calibration Number.
  - ❷ Set the oscilloscope to 50Ω load to measure the main output.
  - ❸ Key in an appropriate Calibration value to set the output to 9.62Vpp ~ 9.78Vpp.
- ↪ The same reason described as 7.13.5, so the formula for Test frequency as below :

The test Frequency of Calibration Number is X, then:

$$X = [(Calibration\ Number - 363) * 250kHz] + 12MHz$$

Press the  key to finish the manual calibration mode, and all new Calibration Value will become effective. Before the key is pressed, none of the modification can be made.

## 8. The Block Diagram and Description of the System

The block diagram of GFG-3015 consists of a micro processor unit (MPU), a Voltage control Frequency (VCF), many digital to analog converters (D/A) for corresponding block, a square and sine waveform Shaper, a modulation function generator, a Trigger signal generator, a Frequency Counter(GFC-9701), an output amplifier, an attenuator (ATT), and etc. The principles of generating waveforms and Function are shown as follows:

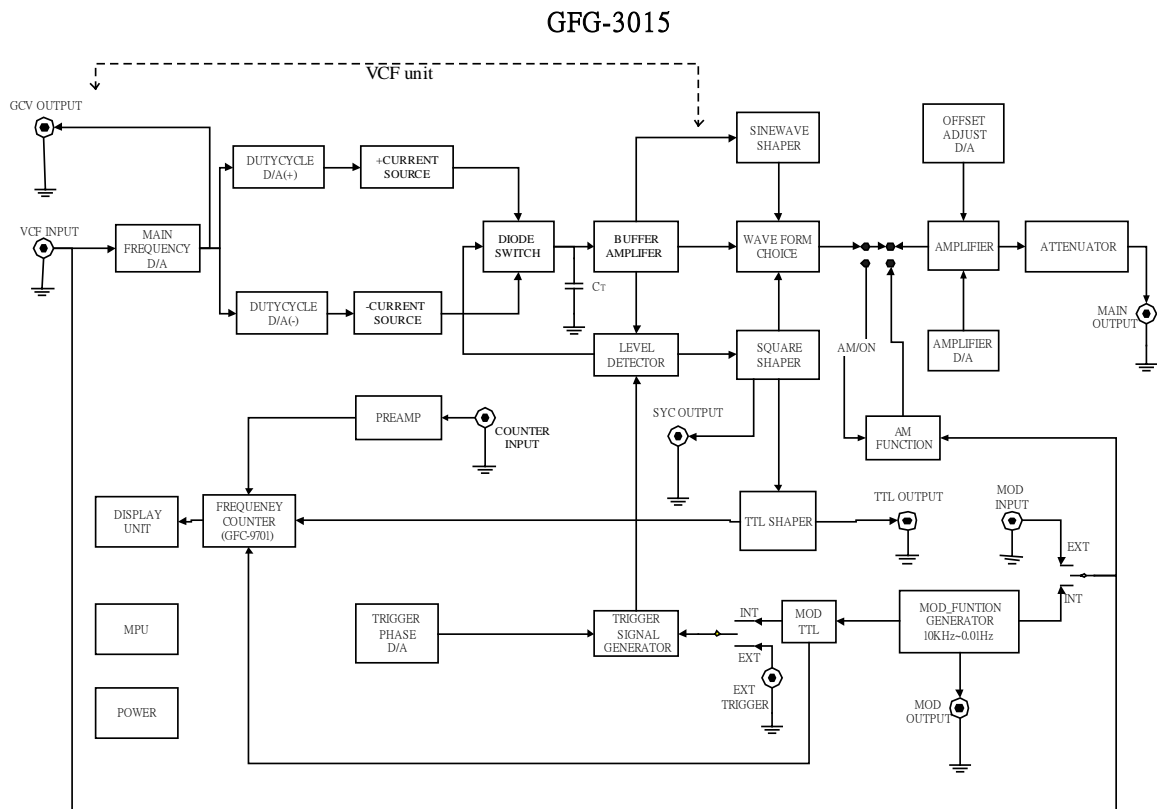

### (1) Power

Provide many kind of DC power for every block of the instrument including  $\pm 18V$ ,  $\pm 15V$  and  $\pm 5V$ .

### (2) MPU

The Micro Processor Unit is a powerful control center of the instrument that can control many key blocks through D/A converter including the Output waveform, the Frequency, Amplitude, the DC offset, the Duty and EXT the setting the parameters of Sweep or modulation, even the Trigger function. It creates a friendly operation environment.

In addition, it can read the output frequency through the powerful Counter (GFC-9701) and modify the output frequency value at the real time. Therefore, it also provides high accurate signal.



### (3) V.C.F

Basically, the Voltage Control Frequency unit is to transform voltage into frequency. It consists of a main frequency D/A, a duty cycle D/A, a positive/negative constant current source, a diode switch unit, a buffer, a level detector and an integral capacitor, and etc.

The MPU puts a specific value to the main frequency D/A which will generate a corresponding voltage for the reference of the duty cycle D/A, then two different polar voltages for current source unit will be generated by the duty cycle D/A, one is a positive voltage from the positive duty cycle D/A and the other is a negative voltage from the negative duty cycle D/A.

The current source block will transform two different polar voltages of the duty cycle D/A output into two different polar correspond constant current. These currents will be charged or discharged by the diode switch unit to the integral capacitor  $C_T$ , and the voltage of the  $C_T$  will become a continuous symmetrical triangle waveform.

The diode switch movement is controlled by the level detector and the voltage of level detector from the triangle waveform, so does the triangle wave oscillator.

If the positive and negative duty cycle D/A has different values, then the current of charge and discharge will be different. Therefore, the triangle waveform should have unsymmetrical duty.

### (4) Frequency setting

The same status as the VCF above, the MPU puts a specific value to the main frequency D/A, the VCF unit will generate a correspond frequency (Symmetrical triangle wave), then, input a desire frequency value to the instrument, the MPU will set the frequency accordingly.

### (5) Description of every kind of Waveform

The GFG-3015 provides many kinds of waveforms including Sine, Triangle, Square, Ramp and Pulse. Please refer to the following for details:

#### 1. Triangle and Ramp Waveform

The same status as the VCF above, the output voltage of the VCF unit is a symmetrical triangle wave which can pass the waveform choice, the output amplifier, the ATT, and the output through the Main Output terminal.

Regarding the Ramp wave, if the positive and negative duty cycle D/A has different value, then the triangle waveform should have unsymmetrical duty, that is the positive and negative Ramp waveform.

#### 2. Sine Waveform

The procedure of generating triangle waveforms is similar to that of generating the sine waveforms, except that the triangle signal can pass a sine wave shaper circuit between the VCF unit and the output amplifier, and the shaper circuit can change the waveform type from triangle to sine.

#### 3. Square and Pulse Waveform

The procedure of generating the triangle waveforms is similar to that of generating the square waveforms. except that the triangle signal can pass a square wave shaper circuit (Comparator circuit) between the VCF unit and the output amplifier.

Regarding the Pulse waveform, if the positive and negative duty cycle D/A has different value, then the square waveform should have unsymmetrical duty, that is the positive and negative Pulse waveform.

## **(6) Amplitude and DC offset**

The Amplifier of GFG-3015 is similar to lineally multiplier (EL4451). The amplitude of this amplifier varies with the different control voltage.

The control voltage comes from the Amplitude of the D/A converter. The MPU puts a specific value to the D/A converter which will generate a corresponding voltage to main output Amplifier, from which, user will get different output amplitude.

The procedure of the amplitude setting is similar to that of DC offset setting, except that there is another D/A converter (Offset adjust D/A) to change the DC offset of output amplifier.

## **(7) Modulation Function**

The GFG-3015 provides two different kinds of modulation functions, one is Amplitude modulation and the other is Frequency modulation.

The instrument has another internal independent function generator which can generate Sine, Triangle, and Square waveform with the frequency range from 0.01Hz to 10kHz, and the symmetry and amplitude of waveform are adjustable. The full function generator is used to make the source for modulation even trigger function.

The detailed principles of modulation is as follows:

### **1. Amplitude Modulation**

The AM function block is for general purpose of the Amplitude modulation circuit (MC1496), including a carrier signal input, an audio signal input and a modulation output. The output amplitude of carrier signal is decided by the audio signal.

The carrier signal is obtained from the main waveform (can select Sine, Triangle and Square), and the audio signal is obtained from a internal independent of function generator.

Set all the parameters of Amplitude modulation by selecting the Waveform (modulation source), the Amplitude (Span), the Frequency (Rate) and the Duty (Symmetry) of the generator.

The output of AM function block is to correct AM waveform and pass the output amplifier, the ATT, and the output through the Main Output terminal. The function includes the internal modulation and the external modulation with the same operation procedure, except that the modulation signal source is obtained from the external MOD input terminal.

### **2. Frequency Modulation**

The principles of the VCF have been described previously, the voltage varies with the different frequency, and the signal obtained from the internal independent function generator is put to the main frequency D/A, then the frequency of the VCF will be according to this signal.

Set all the parameters of the Frequency modulation by selecting the Waveform (modulation source), the Amplitude (Span), the Frequency (Rate) and the Duty (Symmetry) of the generator.

The output of VCF will become FM function waveform and pass the waveform choice, the output amplifier, the ATT, and the output through the Main Out terminal.

This function includes internal modulation and external modulation with the same operation procedure. The only difference with external modulation is that the modulation signal source will come from external MOD input terminal.

## **(8) Sweep Function**

### **1. LIN Sweep**

The procedure of generating the LIN Sweep functions is similar to that of generating the FM function, except that the Ramp waveform is the only signal source.

### **2. LOG Sweep**

The procedure of generating the LOG Sweep functions is similar to that of generating the LIN Sweep functions, except that the signal source will pass a LOG wave shaper circuit (This circuit be included MOD function generator block).

## **(9) Trigger Function**

The Trigger Signal Generator will generate special signal that can instruct the VCF unit to generate/stop waveform.

The Signal obtained from the internal independent function generator must go through a TTL level shaper, as this block only accepts TTL compatible level. So can use the Frequency (Rate) and the Duty (Symmetry) of this generator to set the trigger phase and other parameters of Trigger Function.

The output of VCF is to correct Trigger waveform and pass the waveform choice, the output amplifier, the ATT, and the output through the Main Out terminal.

This function includes the internal and external Trigger with the same operation procedure, except that the Trigger signal will be obtained from the external Trigger input terminal.

## **(10) Frequency Counter**

GW has designed its own full function counter chip, GFC-9701, with high frequency test range for the system.

The counter has the internal and external counter mode for GFG-3015. The most important function for the internal counter mode is to show the main frequency (VCF) on the display. So we take a square signal from Square shaper and change the level to TTL compatible level by TTL shaper block, then the signal will connect with the counter (GFC-9701). Because the counter directly connects with the MPU system, so the MPU can get the correct frequency and show it on the Display.

In addition, as the MPU can get the correct frequency anytime, so it can monitor the output frequency at all the time to keep the accuracy of output frequency.

This function includes the internal and external counter mode with the same operation procedure, except that the external test signal has to pass a preamplifier circuit and change it to TTL compatible level.