

Nikon

DIGITAL CAMERA

COOLPIX P60

User's Manual

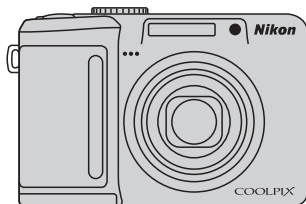

En

Trademark Information

- Microsoft and Windows Vista are either registered trademarks or trademarks of Microsoft Corporation in the United States and/or other countries.
- Macintosh, Mac OS, and QuickTime are trademarks of Apple Inc.
- Adobe and Acrobat are registered trademarks of Adobe Systems Inc.
- The SD logo is a trademark of the SD Card Association.
- PictBridge is a trademark.
- All other trade names mentioned in this manual or the other documentation provided with your Nikon product are trademarks or registered trademarks of their respective holders.

Introduction

First Steps



Basic Photography and Playback: Auto Mode



Shooting Suited for the Scene



High-Sensitivity Shooting Mode

P M

P and M Modes



More on Playback



Movies



Voice Recordings

Connecting to Televisions, Computers and Printers

MENU

Shooting, Playback and Setup Menus

Technical Notes

For Your Safety

To prevent damage to your Nikon product or injury to yourself or to others, read the following safety precautions in their entirety before using this equipment. Keep these safety instructions where all those who use the product will read them. The consequences that could result from failure to observe the precautions listed in this section are indicated by the following symbol:



This icon marks warnings, information that should be read before using this Nikon product, to prevent possible injury.

WARNINGS

Turn off in the Event of Malfunction

Should you notice smoke or an unusual smell coming from the camera or AC adapter, unplug the AC adapter and remove the batteries immediately, taking care to avoid burns. Continued operation could result in injury. After removing or disconnecting the power source, take the equipment to a Nikon-authorized service representative for inspection.

Do not Disassemble

Touching the product's internal parts could result in injury. Repairs should be performed only by qualified technicians. Should the camera break open as the result of a fall or other accident, take the product to a Nikon-authorized service representative for inspection after unplugging the product and/or removing the batteries.

Do not use the Camera or AC Adapter in the Presence of Flammable Gas

Do not use electronic equipment in the presence of flammable gas, as this could result in explosion or fire.

Handle the Camera Strap with Care

Never place the strap around the neck of an infant or child.

Keep out of Reach of Children

Particular care should be taken to prevent infants from putting the batteries or other small parts into their mouths.

Observe caution when handling batteries

Batteries may leak or explode if improperly handled. Observe the following precautions when handling batteries for use in this product:

- Before replacing the batteries, turn the product off. If you are using an AC adapter, be sure it is unplugged.
- Use only the batteries approved for use in this product (📖 14). Do not combine old and new batteries or batteries of different makes or types.
- If Nikon rechargeable EN-MH1 NiMH batteries are purchased separately, charge and use each of them as a set. Do not combine batteries from different pairs.
- Insert batteries in the correct orientation.
- Do not short or disassemble batteries or attempt to remove or break battery insulation or casing.
- Do not expose batteries to flame or to excessive heat.
- Do not immerse in or expose to water.
- Do not transport or store with metal objects such as necklaces or hairpins.
- Batteries are prone to leakage when fully discharged. To avoid damage to the product, be sure to remove the batteries when no charge remains.
- Discontinue use immediately should you notice any change in the batteries, such as discoloration or deformation.

Observe the following precautions when handling the Battery Charger MH-71 (available separately)

- If liquid from damaged batteries comes in contact with clothing or skin, rinse immediately with plenty of water.
- Keep dry. Failure to observe this precaution could result in fire or electric shock.
- Dust on or near the metal parts of the plug should be removed with a dry cloth. Continued use could result in fire.
- Do not handle the power cable or go near the battery charger during lightning storms. Failure to observe this precaution could result in electric shock.
- Do not damage, modify, forcibly tug or bend the power cable, place it under heavy objects, or expose it to heat or flames. Should the insulation be damaged and the wires become exposed, take it to a Nikon-authorized service representative for inspection. Failure to observe these precautions could result in fire or electric shock.
- Do not handle the plug or battery charger with wet hands. Failure to observe this precaution could result in electric shock.

 **Use appropriate cables**

When connecting cables to the input and output jacks, use only the cables provided or sold by Nikon for the purpose, to maintain compliance with product regulations.

 **Handle moving parts with care**

Be careful that your fingers or other objects are not pinched by the lens cover or other moving parts.

 **CD-ROMs**

The CD-ROMs supplied with this device should not be played back on audio CD equipment. Playing CD-ROMs on an audio CD player could cause hearing loss or damage the equipment.

 **Observe caution when using the flash**

Using the flash close to your subject's eyes could cause temporary visual impairment. Particular care should be observed if photographing infants, when the flash should be no less than one meter (39 in.) from the subject.

 **Do not operate the flash with the flash window touching a person or object**

Failure to observe this precaution could result in burns or fire.

 **Avoid Contact with Liquid Crystal**

Should the monitor break, care should be taken to avoid injury caused by broken glass and to prevent liquid crystal from the monitor touching the skin or entering the eyes or mouth.

Notices

Notice for Customers in the U.S.A.

Federal Communications Commission (FCC) Radio Frequency Interference Statement

This equipment has been tested and found to comply with the limits for a Class B digital device, pursuant to Part 15 of the FCC rules. These limits are designed to provide reasonable protection against harmful interference in a residential installation. This equipment generates, uses, and can radiate radio frequency energy and, if not installed and used in accordance with the instructions, may cause harmful interference to radio communications. However, there is no guarantee that interference will not occur in a particular installation. If this equipment does cause harmful interference to radio or television reception, which can be determined by turning the equipment off and on, the user is encouraged to try to correct the interference by one or more of the following measures:

- Reorient or relocate the receiving antenna.
 - Increase the separation between the equipment and receiver.
 - Connect the equipment into an outlet on a circuit different from that to which the receiver is connected.
- Consult the dealer or an experienced radio/television technician for help.



Nikon
COOLPIX P60

CAUTIONS

Modifications

The FCC requires the user to be notified that any changes or modifications made to this device that are not expressly approved by Nikon Corporation may void the user's authority to operate the equipment.

Interface Cables

Use the interface cables sold or provided by Nikon for your equipment. Using other interface cables may exceed the limits of Class B Part 15 of the FCC rules.

Notice for customers in the State of California

WARNING: Handling the cord on this product will expose you to lead, a chemical known to the State of California to cause birth defects or other reproductive harm.

Wash hands after handling.

Nikon Inc.,
1300 Walt Whitman Road, Melville,
New York 11747-3064 USA
Tel: 631-547-4200

Notice for customers in Canada

CAUTION

This Class B digital apparatus complies with Canadian ICES-003.

ATTENTION

Cet appareil numérique de la classe B est conforme à la norme NMB-003 du Canada.

Symbol for Separate Collection in European Countries

This symbol indicates that this product is to be collected separately.



The following apply only to users in European countries:

- This product is designated for separate collection at an appropriate collection point. Do not dispose of as household waste.
- For more information, contact the retailer or the local authorities in charge of waste management.

Table of Contents







For Your Safety	ii
WARNINGS	ii
Notices	v
<hr/>	
Introduction	1
About This Manual	1
Information and Precautions	2
Parts of the Camera	4
The Camera Body	4
Attaching the Camera Strap	4
The Monitor	6
Basic Operations	8
The □ Button	8
The Mode Dial	10
The Multi Selector	11
The MENU Button	12
Help Displays	13
<hr/>	
First Steps	14
Inserting Batteries	14
Supported Batteries	14
Turning On and Off the Camera	14
Setting Display Language, Date and Time	18
Inserting Memory Cards	16
Removing Memory Cards	19
<hr/>	
 Basic Photography and Playback: Auto Mode	20
Step 1 Turn the Camera On and Select  (Auto) Mode	20
Step 2 Frame a Picture	22
Step 3 Focus and Shoot	24
Step 4 Viewing and Deleting Pictures	26
Using the Flash	28
Setting the Flash Mode	28
Shooting with the Self-timer	30
Choosing a Focus Mode	31
Setting the Focus Mode	31
Exposure Compensation	32

Table of Contents

 SCENE Shooting Suited for the Scene	33
Scene Mode	33
Shooting in Scene Modes	34
Features	35
 High-Sensitivity Shooting Mode	42
Shooting in High-Sensitivity Shooting Mode	42
PM P and M Modes	43
P (Programmed Auto) Mode.....	43
M (Manual) Mode.....	44
 More on Playback	47
Viewing Multiple Pictures: Thumbnail Playback	47
Taking a Closer Look: Playback Zoom	48
Editing Pictures.....	49
Enhancing Brightness and Contrast: D-Lighting.....	50
Creating a Cropped Copy: Crop	51
Resizing Pictures: Small Picture.....	52
Voice Memos: Recording and Playback	53
Recording Voice Memos.....	53
Playing Voice Memos	53
Deleting Voice Memos	53
 Movies	54
Recording Movies	54
The Movie Menu	55
Selecting Movie Options.....	55
Autofocus Mode.....	56
Electronic VR.....	56
Movie Playback	57
Deleting Movie Files.....	57

































 Voice Recordings	58
Making Voice Recordings.....	58
Playing Voice Recordings.....	60
Deleting Sound Files.....	60
Copying Voice Recordings.....	61
<hr/>	
Connecting to Televisions, Computers and Printers	62
Connecting to a TV.....	62
Connecting to a Computer.....	63
Before Connecting the Camera.....	63
Transferring Pictures from the Camera to a Computer	64
Connecting to a Printer.....	67
Connecting the Camera and Printer.....	68
Printing Pictures One at a Time	69
Printing Multiple Pictures	70
Creating a DPOF Print Order: Print Set.....	73
<hr/>	
MENU Shooting, Playback and Setup Menus	75
Shooting Options: The Shooting Menu	75
Displaying the Shooting Menu and High-sensitivity Menu	76
 Image Quality.....	76
 Image Size.....	77
 Optimize Image.....	79
 White Balance.....	81
 ISO Sensitivity.....	83
 Metering	84
 Continuous	85
 AF Area Mode	86
 Autofocus Mode	88
 Flash Exp. Comp.....	89
Restrictions on Camera Settings	90
Playback Options: The Playback Menu	91
Displaying the Playback Menu	91
 Slide Show.....	93
 Delete	94
 Protect	94
 Copy.....	95

Table of Contents

Basic Camera Setup: The Setup Menu	96
Displaying the Setup Menu.....	97
 Menus.....	97
 Welcome Screen.....	98
 Date.....	99
 Monitor Settings.....	102
 Date Imprint.....	103
 Vibration Reduction.....	105
 AF Assist.....	105
 Digital Zoom.....	106
 Sound Settings.....	106
 Auto Off.....	107
 Format Memory/  Format Card.....	107
 Language.....	108
 Video Mode.....	108
 Reset All.....	108
 Battery Type.....	111
 Firmware Version.....	111
<hr/>	
Technical Notes	112
Optional Accessories	112
Approved Memory Cards.....	112
Image/Sound File and Folder Names	113
Caring for the Camera	114
Cleaning.....	116
Storage.....	116
Error Messages	117
Troubleshooting	121
Specifications	126
Supported Standards.....	128
Index	129

About This Manual

Thank you for your purchase of a Nikon COOLPIX P60 digital camera. This manual was written to help you enjoy taking pictures with your Nikon digital camera. Read this manual thoroughly before use, and keep it where all those who use the product will read it.

Symbols and Conventions

To make it easier to find the information you need, the following symbols and conventions are used:



This icon marks cautions, information that should be read before use, to prevent damage to the camera.



This icon marks tips, additional information that may be helpful when using the camera.



This icon marks notes, information that should be read before using the camera.



This icon indicates that more information is available elsewhere in this manual or in the *Quick Start Guide*.

Notations

- A Secure Digital (SD) memory card is referred to as a “memory card”.
- The setting at the time of purchase is referred to as the “default setting”.
- Unless otherwise specified, “monitor” is used to refer to both the monitor and electronic viewfinder.
- The names of menu items displayed in the camera monitor, and the names of buttons or messages displayed in the computer monitor are indicated in bold.

Screen Samples

In this manual, images are sometimes omitted from monitor display samples so that indicators in the monitor can be more clearly shown.

Illustrations and Screen Display

Illustrations and text displays shown in this manual may differ from actual display.

Memory Cards

Pictures taken with this camera can be stored in the camera’s internal memory or on removable memory cards. If a memory card is inserted, all new pictures will be stored on the memory card and delete, playback and format operations will apply only to the pictures on the memory card. The memory card must be removed before the internal memory can be formatted or used to store, delete or view pictures.

Information and Precautions

Life-Long Learning

As part of Nikon's "Life-Long Learning" commitment to ongoing product support and education, continually updated information is available online at the following sites:

- For users in the U.S.A.: <http://www.nikonusa.com/>
- For users in Europe and Africa: <http://www.europe-nikon.com/support/>
- For users in Asia, Oceania, and the Middle East: <http://www.nikon-asia.com/>

Visit these sites to keep up-to-date with the latest product information, tips, answers to frequently asked questions (FAQs), and general advice on digital imaging and photography. Additional information may be available from the Nikon representative in your area. See the URL below for contact information:

<http://nikonimaging.com/>

Use Only Nikon Brand Electronic Accessories

Nikon COOLPIX cameras are designed to the highest standards and include complex electronic circuitry. Only Nikon brand electronic accessories (including battery chargers, batteries, and AC adapters) certified by Nikon specifically for use with this Nikon digital camera are engineered and proven to operate within the operational and safety requirements of this electronic circuitry.

THE USE OF NON-NIKON ELECTRONIC ACCESSORIES COULD DAMAGE THE CAMERA AND MAY VOID YOUR NIKON WARRANTY.

For more information about Nikon brand accessories, contact a local authorized Nikon dealer.

Before Taking Important Pictures

Before taking pictures on important occasions (such as at weddings or before taking the camera on a trip), take a test shot to ensure that the camera is functioning normally. Nikon will not be held liable for damages or lost profits that may result from product malfunction.

About the Manuals

- No part of the manuals included with this product may be reproduced, transmitted, transcribed, stored in a retrieval system, or translated into any language in any form, by any means, without Nikon's prior written permission.
- Nikon reserves the right to change the specifications of the hardware and software described in these manuals at any time and without prior notice.
- Nikon will not be held liable for any damages resulting from the use of this product.
- While every effort was made to ensure that the information in these manuals is accurate and complete, we would appreciate it were you to bring any errors or omissions to the attention of the Nikon representative in your area (address provided separately).

Notice Concerning Prohibition of Copying or Reproduction

Note that simply being in possession of material that was digitally copied or reproduced by means of a scanner, digital camera or other device may be punishable by law.

- **Items prohibited by law from being copied or reproduced**

Do not copy or reproduce paper money, coins, securities, government bonds or local government bonds, even if such copies or reproductions are stamped "Sample." The copying or reproduction of paper money, coins, or securities which are circulated in a foreign country is prohibited. Unless the prior permission of the government was obtained, the copying or reproduction of unused postage stamps or post cards issued by the government is prohibited. The copying or reproduction of stamps issued by the government and of certified documents stipulated by law is prohibited.

- **Cautions on certain copies and reproductions**

The government has issued cautions on copies or reproductions of securities issued by private companies (shares, bills, checks, gift certificates, etc.), commuter passes or coupon tickets, except when a minimum of necessary copies are to be provided for business use by a company. Also, do not copy or reproduce passports issued by the government, licenses issued by public agencies and private groups, ID cards and tickets, such as passes and meal coupons.

- **Comply with copyright notices**

The copying or reproduction of copyrighted creative works such as books, music, paintings, woodcut prints, maps, drawings, movies and photographs is governed by national and international copyright laws. Do not use this product for the purpose of making illegal copies or to infringe copyright laws.

Disposing of Data Storage Devices

Please note that deleting images or formatting data storage devices such as memory cards or built-in camera memory does not completely erase the original image data. Deleted files can sometimes be recovered from discarded storage devices using commercially available software, potentially resulting in the malicious use of personal image data. Ensuring the privacy of such data is the user's responsibility.

Before discarding a data storage device or transferring ownership to another person, erase all data using commercial deletion software, or format the device and then completely refill it with images containing no private information (for example, pictures of empty sky). Be sure to also replace any pictures selected for the welcome screen (📷 98). Care should be taken to avoid injury or damage to property when physically destroying data storage devices.

Parts of the Camera

The Camera Body

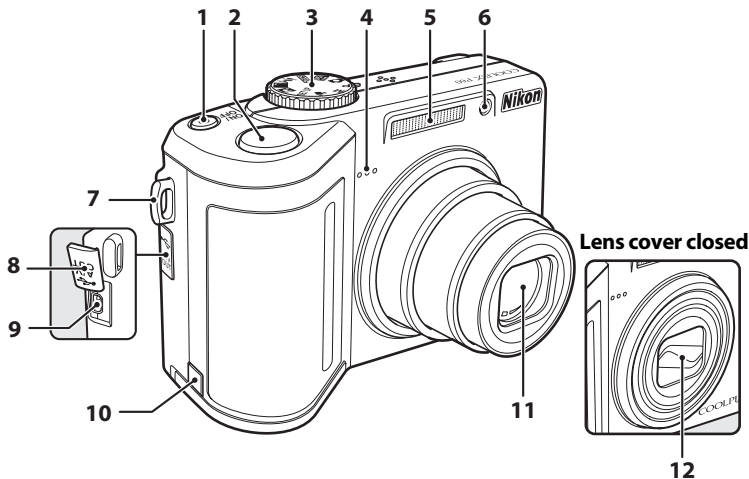

1	Power switch/power-on lamp	14, 107	7	Eyelet for camera strap	
2	Shutter-release button	24	8	Connector cover	62, 64, 68
3	Mode dial	10	9	Cable connector	62, 64, 68
4	Microphone	53, 54, 58	10	Power connector cover	112
5	Built-in flash	28	11	Lens	116, 126
6	Self-timer lamp	30	12	Lens cover	
	AF-assist illuminator	25, 105			

Attaching the Camera Strap

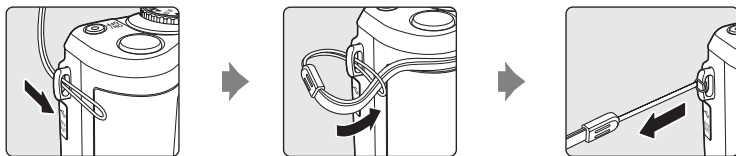

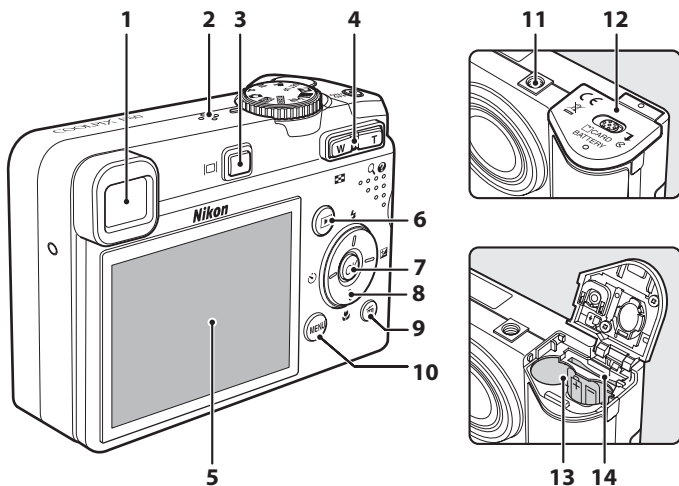

1	Electronic viewfinder	22	7	OK button	11
2	Speaker	53, 57, 60	8	Multi selector.....	11
3	 □ (monitor) button	8	9	☒ (delete) button.....	26, 27, 53, 57, 60
4	Zoom buttons	22	10	MENU (menu) button.....	12, 55, 76, 91
	W (wide)	22	11	Tripod socket	
	T (tele)	22	12	Battery-chamber/memory card slot cover.....	14, 18
	☒ (thumbnail playback)	47	13	Battery chamber.....	14
	☉ (playback zoom)	48	14	Memory card slot.....	18
	? (help)	13			
5	Monitor	6, 8, 21			
6	▶ (playback) button	26			

The Monitor

The following indicators may appear in the monitor during shooting and playback (actual display varies with current camera settings).

- See “The  Button” (8) for information on switching between the monitor and electronic viewfinder.

Shooting

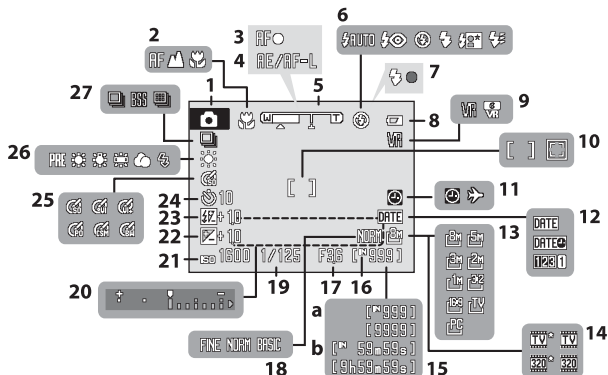

1	Shooting mode*20, 33, 42, 43, 44, 54
2	Focus mode..... 31
3	Focus indicator24
4	Exposure/focus lock41
5	Zoom indicator.....22
6	Flash mode.....28
7	Flash indicator29
8	Battery level indicator 20
9	Vibration reduction icon (still pictures)21,105
9	Electronic VR icon (movies)..... 56
10	Focus area..... 24, 86
10	Focus area (when a face is recognized) 86
11	“Date not set” indicator117
11	Time zone indicator 99
12	Date imprint/date counter..... 103

13	Image size.....77
14	Movie option55
15	a Number of exposures remaining...20
15	b Movie length.....54
16	Internal memory indicator21
17	Aperture46
18	Image quality76
19	Shutter speed.....46
20	Exposure display44
21	ISO sensitivity29, 83
22	Exposure compensation32
23	Flash exposure compensation89
24	Self-timer indicator30
25	Image optimization.....79
26	White balance.....81
27	Continuous shooting mode85

* Differs according to the current shooting mode. Refer to the sections on each mode for details.

Playback

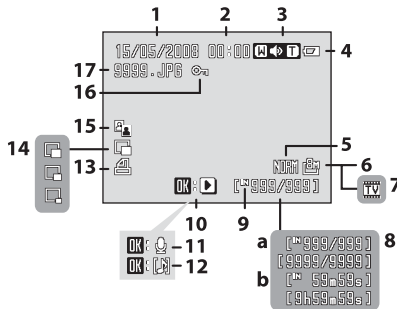

1	Date of recording	16	10	Movie playback indicator	57
2	Time of recording.....	16	11	Voice memo recording guide	53
3	Volume indicator.....	53, 57	12	Voice memo playback guide.....	53
4	Battery level indicator.....	20	13	Print-order icon.....	73
5	Image quality*	76	14	Small picture indicator	52
6	Image size*	77	15	D-Lighting icon	50
7	Movie option*	57	16	Protect icon	94
8	a Current frame number/ total number of frames	26	17	File number and type	113
	b Movie length.....	57			
9	Internal memory indicator.....	26			

* Differs according to the selected movie option.

Basic Operations

The Button

Press  to switch between monitor and electronic viewfinder display, and to hide or show indicators and photo info, during shooting and playback.

With Shooting



Monitor on

View through lens, indicators, and photo info displayed



Monitor on

Only view through lens is displayed



Electronic viewfinder on

Only view through lens is displayed



Electronic viewfinder on

View through lens, indicators, and photo info displayed

The following settings can be applied from the **Monitor settings** item ( 102) in the setup menu ( 96).

- Choose whether to switch between monitor and electronic viewfinder display with photo info displayed, or without photo info displayed.
- Show or hide framing guides in shooting mode.
- Choose whether the monitor or the electronic viewfinder display is activated when the camera is turned on.

With Playback

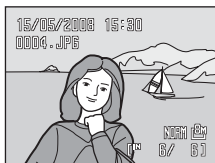

Monitor on
Picture and photo info
displayed

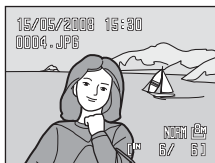

Electronic viewfinder on
Picture and photo info
displayed

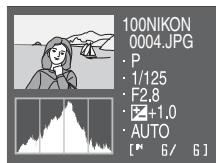

Monitor on
Picture and shooting data
displayed (see below)



Monitor on
Only the picture is displayed



Shooting data: Shows the folder name, file name, current frame number/total number of frames, exposure mode, shutter speed, aperture, exposure compensation, ISO sensitivity, and histogram for the current picture. Shooting data are not displayed if the current picture is a movie.

- **Histogram:** A graph showing tone distribution. The horizontal axis corresponds to pixel brightness, with dark tones to the left and bright tones to the right; the vertical axis shows number of pixels of each brightness in image.
- **Exposure mode:** **P** or **M** (43). **P** is also displayed on pictures taken in **(auto)**, **(high sensitivity)**, **(SCENE)** (scene), **(portrait)**, **(landscape)**, and **(night portrait)** modes.

The Multi Selector

This section describes standard uses of the multi selector to select modes, select menu options and to apply selection.

With Shooting

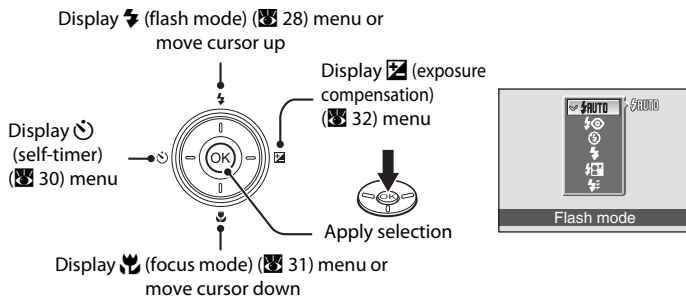

With Playback

Choose the previous picture

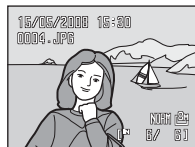
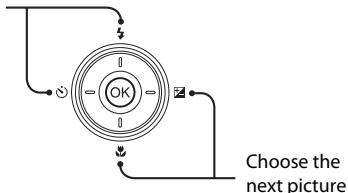

With Menu Screens

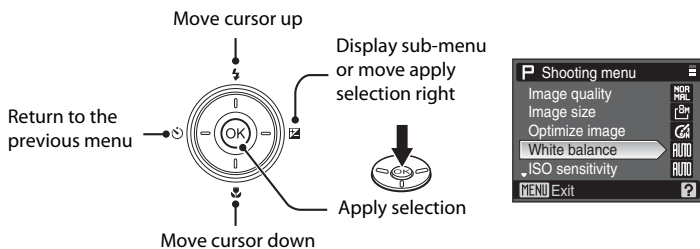

Note on the Multi Selector

In the manual, the button indicating up, down, left and right of the multi selector is shown as ▲, ▼, ◀, and ▶.

The MENU Button

Press **MENU** to display the menu for the selected mode. Use the multi selector to navigate the menus (11).

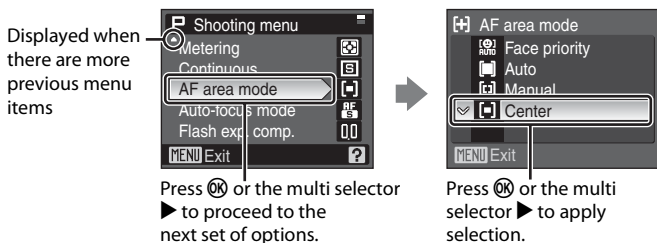
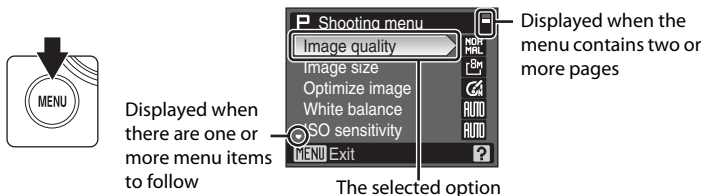

Help Displays

Press **T** (?) when (?) is displayed at the lower right of the menu screen to view a description of the currently selected menu option.

To return to the original menu, press **T** (?) again.

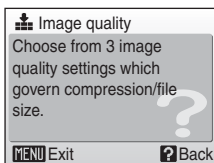
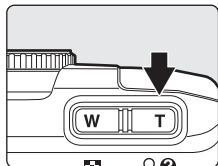

Inserting Batteries

- 1 Open the battery-chamber/memory card slot cover.

Hold the camera upside down to prevent the batteries from falling out.

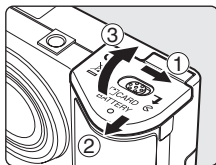

- 2 Insert the batteries.

Insert the batteries correctly as shown at right.

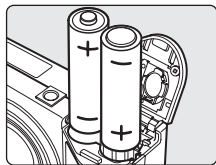

- 3 Close the battery-chamber/memory card slot cover.

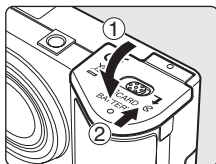

Supported Batteries

This camera uses the following batteries.



- Two LR6 alkaline (AA-size) batteries (supplied)
- Two ZR6 oxyride (AA-size) batteries (available separately)
- Two FR6 lithium (AA-size) batteries (available separately)
- Two EN-MH1 Rechargeable Ni-MH Batteries (available separately from Nikon)

Turning On and Off the Camera

To turn on the camera, press the power switch. The power-on lamp (green) will light for a moment and the monitor will turn on.

To turn off the camera, press the power switch again.

When the camera is turned off, both the power-on lamp and monitor will turn off.

- If the camera is turned off, hold down  to turn the camera on in playback mode ( 26).

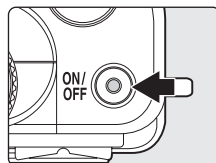

✓ Replacing Batteries

Turn the camera off and make sure that the power-on lamp and monitor are off before opening the battery-chamber/memory card slot cover to remove or insert batteries.

✓ Additional Precautions Regarding Batteries

- Read and follow the warnings for batteries on pages iii and the section, “Caring for the Camera” (📖 115).
- Do not combine old and new batteries or batteries of different makes or types.
- Batteries with the following defects cannot be used:

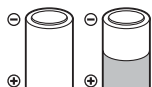

Batteries with peeling



Batteries with insulation that does not cover the area around the negative terminal

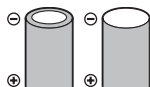

Batteries with a flat negative terminal

✓ Battery Type

To improve battery performance, select the type of battery currently inserted in the camera in the setup menu. The default setting is **Alkaline**. When any other type of battery is used, turn the camera on and change the setting (📖 111).

🔪 Alkaline Batteries

Performance of alkaline batteries may vary greatly depending on the manufacturer. Choose a reliable brand.

🔪 AC Adapter

The AC Adapter EH-65A (available separately from Nikon) can be used to power the COOLPIX P60 from an electrical outlet. Do not, under any circumstances, use another make or model of AC adapter. Failure to observe this precaution could result in overheating or in damage to the camera.

🔪 Auto Power-Off in Shooting Mode (Standby Mode)

The monitor will dim to reduce the drain on the batteries if no operations are performed for about five seconds. The monitor will brighten when camera controls are used. At default settings, the monitor will turn off altogether if no operations are performed for about 30 seconds during shooting and playback. The camera will turn off automatically if no operations are performed for another three minutes (📖 107).

Setting Display Language, Date and Time

A language-selection dialog is displayed the first time the camera is turned on.

1 Press the power switch to turn on the camera.

The power-on lamp (green) will light for a moment and the monitor will turn on.

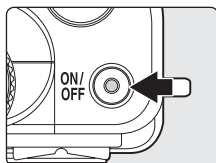

2 Press the multi selector ▲ or ▼ to choose the desired language, and press OK.

For information on using the multi selector, see “The Multi Selector” (11).



3 Press the multi selector ▲ or ▼ to choose **Yes**, and press OK.

If **No** is selected, the date and time will not be set.

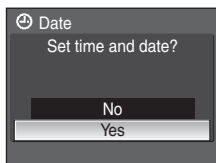

4 Press OK.

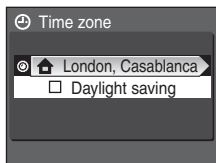

Daylight Saving Time

If daylight saving time is in effect, turn on **Daylight saving** in the time zone menu and set the date.

- 1 Before pressing OK, press the multi selector ▼ to choose **Daylight saving**.
- 2 Press OK to enable daylight saving time (✓). Pressing OK toggles the daylight saving time option on and off.
- 3 Press the multi selector ▲, and then press OK to proceed to step 5.

- 5** Press the multi selector ◀ or ▶ to select your home time zone (F101), and press OK.



- 6** Edit the date.

Press the multi selector ▲ or ▼, to edit the highlighted item.

Press ▶ to move the highlight in the following order.

D (day) → **M** (month) → **Y** (year) → hour → minute →

DMY (the order in which the day, month, and year are displayed)

Press ◀ to return to the previous item.

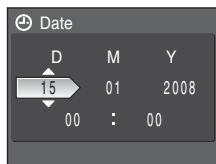

- 7** Choose the order in which the day, month and year are displayed and press OK or the multi selector ▶.

The settings are applied and monitor display exits to shooting mode.

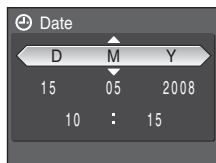

Changing the Date and Time

- Select **Date** from the **Date** item (F99) in the setup menu (F96) to change the current date and time and follow the procedure described in step 6 above.
- Select **Time zone** from the **Date** item (F99) in the setup menu (F96) to change the time zone and daylight saving time settings.

Inserting Memory Cards

Pictures are stored in the camera's internal memory (approx. 12 MB) or on removable Secure Digital (SD) memory cards (available separately) (📷 112).

If a memory card is inserted in the camera, pictures are automatically stored on the memory card and pictures recorded to the memory card can be played back, deleted or transferred. Remove the memory card to store pictures in the internal memory, or play back, delete or transfer pictures from the internal memory.

First Steps

1 Confirm that the camera is off and open the battery-chamber/memory card slot cover.

Make sure that the camera is off (power-on lamp is off) before inserting or removing the memory card.

When opening the battery-chamber/memory card slot cover, hold the camera upside down to prevent the batteries from falling out.

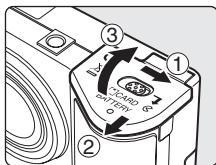

2 Insert the memory card.

Slide the memory card in correctly until it clicks into place.

Close the battery-chamber/memory card slot cover.

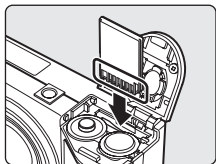

❑ Inserting Memory Cards

Inserting the memory card upside down or backwards could damage the camera or the memory card. Make sure that the memory card is correctly oriented.

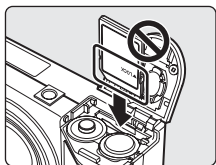

Removing Memory Cards

Before removing memory cards **turn the camera off** and confirm that the power-on lamp and monitor are off. Open the battery-chamber/memory card slot cover and press the card in ① to partially eject the card ②. The card can then be removed by hand.

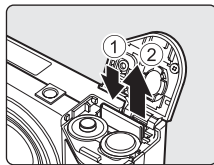

✔ Formatting Memory Cards

If the message at right is displayed, the memory card must be formatted before use (☒ 107). Note that **formatting permanently deletes all pictures and other data** on the memory card. Be sure to make copies of any pictures you wish to keep before formatting the memory card.

Use the multi selector to choose **Yes** and press **OK**. A confirmation dialog is displayed. To start formatting, choose **Format** and press **OK**.

- **Do not turn the camera off or open the battery-chamber/memory card slot cover until formatting is complete.**
- The first time you insert the memory cards used in other devices into the COOLPIX P60, be sure to format them (☒ 107) with this camera.

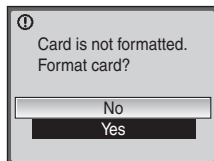

✔ The Write Protect Switch

SD memory cards are equipped with a write protect switch. Pictures cannot be recorded or deleted and the memory card cannot be formatted when this switch is in the "lock" position. Unlock by sliding the switch to the "write" position.

Write protect switch

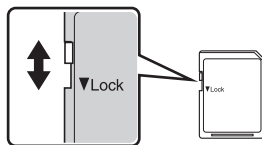

✔ Memory Cards

- Use only Secure Digital memory cards.
- Do not perform the following during formatting, while data is being written to or deleted from the memory card, or during data transfer to a computer. Failure to observe this precaution could result in the loss of data or in damage to the camera or memory card:
 - Eject the memory card
 - Remove the batteries
 - Turn off the camera
 - Disconnect the AC adapter
- Do not disassemble or modify.
- Do not drop, bend, or expose to water or strong physical shocks.
- Do not touch the metal terminals with your fingers or metal objects.
- Do not affix labels or stickers to the memory card.
- Do not leave in direct sunlight, closed vehicles or areas exposed to high temperatures.
- Do not expose to humidity, dust, or to corrosive gases.

Step 1 Turn the Camera On and Select (Auto) Mode

This section describes how to take a picture in  (auto) mode, an automatic, “point-and-shoot” mode recommended for first-time users of digital cameras.

- 1 Rotate the mode dial to .

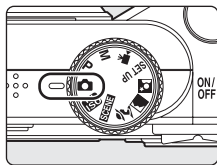

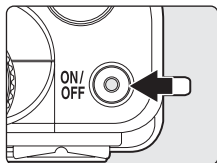

- 2 Press the power switch to turn on the camera.

The power-on lamp (green) will light for a moment, the monitor will turn on, and the lens will extend.



- 3 Check the battery level and number of exposures remaining.

Battery Level

Monitor	Description
NO INDICATOR	Batteries fully charged.
	Batteries low; prepare to replace the batteries.
 Battery exhausted.	Cannot shoot. Replace with fresh batteries.

Battery level indicator

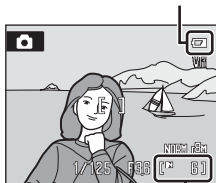

Number of exposures remaining





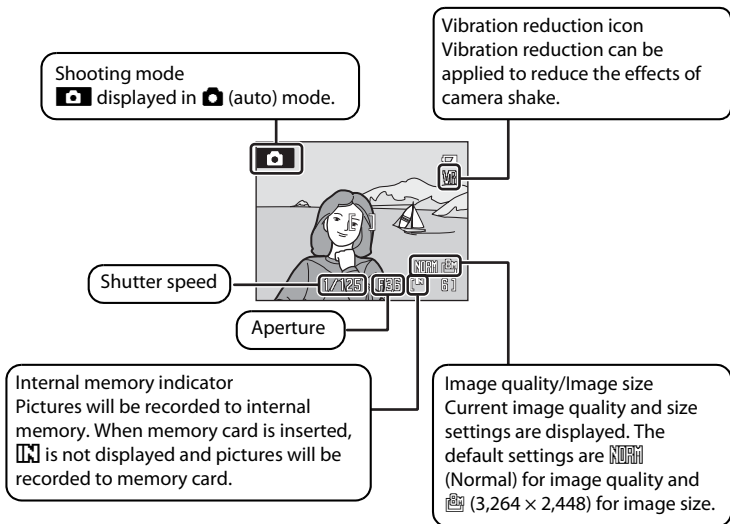

Number of Exposures Remaining

The number of pictures that can be stored depends on the capacity of the memory or memory card, image quality, and image size ( 78).

Indicators Displayed in (Auto) Mode





Available Functions in (Auto) Mode

In  (auto) mode, focus mode ( 31) and exposure compensation ( 32) can be applied and the camera can shoot using the flash mode ( 28) and self-timer ( 30). Pressing **MENU** displays the shooting menu options for specifying the image quality ( 76) and image size ( 77).

Vibration Reduction

Vibration reduction ( 105), when **On** (default setting) is selected, can be applied to effectively reduce blur, caused by slight hand movement known as camera shake, that commonly occurs when shooting with zoom applied or at slow shutter speeds.

Set **Vibration reduction** to **Off** when using a tripod to stabilize the camera during shooting.

To reduce the effects of camera shake when recording movies, enable **Electronic VR** ( 56) from the movie menu ( 55).

Shutter Speed and Aperture

Shutter speed and aperture settings, adjusted by the camera to suit shooting conditions, are displayed.

In **M** (manual) mode ( 44), shutter speed and aperture can be specified manually.

Step 2 Frame a Picture

1 Ready the camera.

Hold the camera steadily in both hands, keeping your fingers and other objects away from the lens, flash, AF-assist illuminator, and microphone.

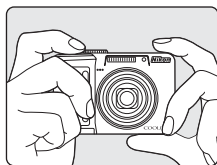

When shooting in "tall" (portrait) orientation, hold the camera so that the flash is up.

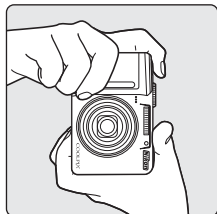

2 Frame the picture.

Position the main subject near the center of the monitor.

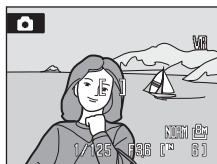

Using the Electronic Viewfinder

Use the electronic viewfinder to frame pictures when bright light makes it difficult to see the display in the monitor. Press **[Q]** to switch to the electronic viewfinder (**8**).

Using the Zoom

Use the zoom buttons to activate optical zoom. Press **T** (**Q**) to zoom in so that the subject fills a larger area of the frame, or **W** (**8**) to zoom out, increasing the area visible in the frame.

When the zoom buttons are pressed, the zoom indicator is displayed at the top of the monitor display.

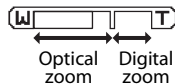
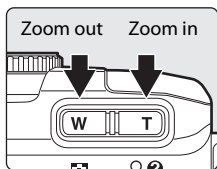

Digital Zoom

When the camera is zoomed in to the maximum magnification (5x), holding down **T** (Q) triggers digital zoom. The subject is magnified up to an additional 4x, for a total magnification of 20x.

When digital zoom is in effect, the focus area will not be displayed and the camera will focus on the subject in the center focus area.

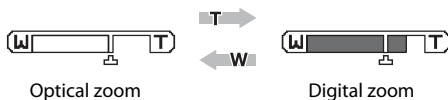







If possible, digital zoom will create a picture by cropping the area visible in the monitor to the current image size (77), increasing magnification without affecting quality.

If the crop would be smaller than the current image size, additional pixels are added through a process known as interpolation, creating a slightly “grainy” image.

⏏ is displayed, below the zoom indicator, at the maximum zoom ratio possible before interpolation is applied. When zoom is increased beyond this point, the zoom indicator turns yellow and interpolation is applied.

Maximum zoom ratio without interpolation

As smaller image size settings (77) are applied, ⏏ shifts closer to the **T** (Q) position. The degree of zoom available before interpolation is used depends on the option currently selected for image size, as shown in the following table. The camera pauses temporarily in its zooming operation when it reaches the maximum zoom ratio possible before interpolation is used. Interpolation will begin if you continue pressing **T** (Q) to further increase the zoom ratio.

Image size	Zoom ratio	Image size	Zoom ratio
	5.0x (up to the maximum optical zoom ratio)		10.0x (digital zoom up to 2.0x)
	6.0x (digital zoom up to 1.2x)		12.0x (digital zoom up to 2.4x)
	7.0x (digital zoom up to 1.4x)		15.0x (digital zoom up to 3.0x)
			20.0x (digital zoom up to 4.0x)

Digital zoom can be limited to the range at which interpolation is not in effect, or it can be turned off (106).

Step 3 Focus and Shoot

1 Press the shutter-release button halfway.

The camera automatically focuses on the subject in the center focus area.

When the subject is in focus, the focus area will glow green.

When digital zoom is in effect, and the subject is in focus, the focus indicator ( 6) will glow green. The focus area is not displayed.

Focus and exposure remain locked while the shutter-release button is pressed halfway. When the camera is unable to focus, the focus area, or focus indicator, blinks red. Change the composition and try again.

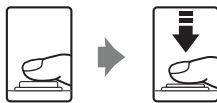

2 Press the shutter-release button the rest of the way down.

The shutter will be released, and the picture will be recorded to the memory card or internal memory.



Shutter-release Button

The camera features a two-stage shutter-release button. To set focus and exposure, press the shutter-release button halfway, stopping when you feel resistance. Focus and exposure lock while the shutter-release button is held in this position. To release the shutter and take a picture, press the shutter-release button the rest of the way down.

Do not use force when pressing the shutter-release button, as this may result in camera shake and blurred pictures.



Press the shutter-release button halfway to set focus and exposure.

Press the shutter-release button the rest of the way down to take a picture.

✓ During Recording

While pictures are being recorded, the ⏸ (wait) icon will be displayed, or the number of exposures remaining/movie length indicator will blink. Do not turn the camera off, open the battery-chamber/memory card slot cover, or remove or disconnect the power source while these icons are displayed. Cutting power or removing the memory card in these circumstances could result in loss of data or in damage to the camera or card.

🔗 Autofocus

Autofocus may not perform as expected in the following situations. In some rare cases, the subject may not be in focus despite the fact that the active focus area, or focus indicator, glows green:

- Subject is very dark
- Objects of sharply differing brightness are included in the scene (e.g. the sun is behind the subject and is in deep shadow)
- No contrast between the subject and surroundings (e.g. when the subject is standing in front of a white wall, wearing a white shirt)
- Several objects are at different distances from the camera (e.g. the subject is inside a cage)
- Subject is moving rapidly

In the situations noted above, try pressing the shutter-release button halfway to refocus several times, or focus on another subject and use focus lock. When using focus lock, be sure that the distance between the camera and the subject with which focus was locked is the same as that for the actual subject.

👁️ Focus Lock

To focus on an off-center subject when **Center** is selected for **AF area mode**, use focus lock as described below.

- Be sure that the distance between the camera and the subject does not change while focus is locked.
- When the shutter-release button is pressed halfway, exposure is locked.



Position the subject in the center focus area.



Press the shutter-release button halfway.



Confirm that the focus area is green.



Continue holding down the shutter-release button halfway and recompose the picture.



Press the shutter-release button the rest of the way down.

👁️ AF-assist Illuminator and Flash

If the subject is poorly lit, the AF-assist illuminator may light by pressing the shutter-release button halfway, or the flash may fire by pressing the shutter-release button all the way down. The illuminator has a range of about 1.9 m (6 ft. 2 in.) at the maximum wide-angle position and about 1.1 m (3 ft. 3 in.) at the maximum telescopic position. The AF-assist illuminator can be set to **Off** manually (🔗 105), although in this case the camera may not focus when lighting is poor.

Step 4 Viewing and Deleting Pictures

Viewing Pictures (Playback Mode)



Press .

The last picture taken will be displayed in full-frame playback mode.

Press the multi selector , , , or  to view additional pictures. Hold down the multi selector , , , or  to fast forward pictures.

Pictures may be displayed briefly at low resolution while being read from the memory card or internal memory.

Press  or the shutter-release button to switch to shooting mode.

When  is displayed, pictures stored in the internal memory will be displayed. When memory card is inserted,  is not displayed and pictures stored on the memory card will be displayed.

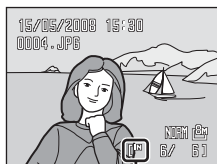
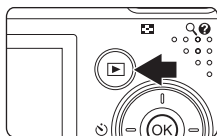



Internal memory indicator

Deleting Pictures

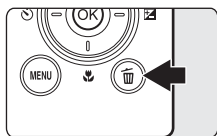
- 1 Press  to delete the picture currently displayed.







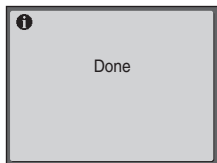
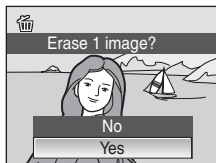



- 2 Use the multi selector to select **Yes** and press .

To exit without deleting the picture, select **No** and press .



Playback Mode

The following options are available in full-frame playback mode.

Option	Use	Description	
Playback zoom	T (Q)	Press T (Q) to enlarge view of picture currently displayed, up to about 10x. Press OK to return to full-frame playback mode.	48
View thumbnails	W 	Press W  to display four-, nine- or 16- picture thumbnails.	47
Change monitor display		Press  to switch between the monitor and electronic viewfinder displays, or to hide or show photo info or shooting data.	8
Record/play voice memo	OK	Press OK to record or play back voice memos up to 20 seconds in length.	53
Switch to shooting mode	  	Press  or the shutter-release button to switch to the mode selected with the mode dial.	26

Pressing to Turn On the Camera

When the camera is off, holding down  will turn the camera on in playback mode. The lens does not extend.

Viewing Pictures

Pictures stored in the internal memory can only be viewed if no memory card is inserted.

Deleting the Last Picture Taken

In shooting mode, press  to delete the last picture taken.

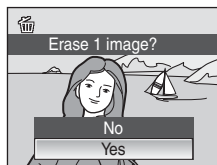

Using the Flash

The flash has a range of about 0.4-5.1 m (1 ft. 4 in.-16 ft. 8 in.) when the camera is zoomed out all the way. With maximum optical zoom applied, the range is about 0.6-4.0 m (2 ft.-13 ft.) (when **ISO sensitivity** is set to **Auto**). The following flash modes are available.

 **Auto** (default setting for  (auto) mode)

Flash fires automatically when lighting is poor.

 **Auto with red-eye reduction**

Reduces “red-eye” in portraits ( 29).

 **Off**

Flash will not fire even when lighting is poor.

 **Fill flash**

Flash fires when a picture is taken. Use to “fill-in” (illuminate) shadows and backlit subjects.

 **Slow sync**

 (auto) is combined with slow shutter speed. Flash illuminates main subject; slow shutter speeds are used to capture background at night or under dim light.

 **Rear-curtain sync**

Flash fires just before shutter closes, creating effect of a stream of light behind moving subjects.

Setting the Flash Mode

1 Press (flash mode).

The flash menu is displayed in the monitor.

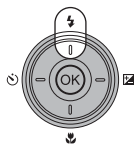

2 Use the multi selector to choose the desired flash mode and press .

The icon for the selected flash mode is displayed.

When  (auto) is applied,  is only displayed for five seconds.

If a setting is not applied by pressing  within a few seconds, the selection will be cancelled.

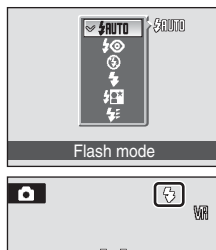

✔ Shooting When Lighting Is Poor and the Flash Is Disabled (🔋)

- Use of a tripod is recommended to stabilize the camera during shooting and avoid the effects of camera shake. Set **Vibration reduction** (🔊 105) to **Off** when using a tripod to stabilize the camera during shooting.
- The **ISO** symbol is displayed when the camera automatically increases sensitivity to minimize blur caused by slow shutter speed. Pictures taken when **ISO** is displayed may be slightly mottled.
- Noise reduction may be automatically applied as pictures taken are recorded; results in increased recording times.

✔ Note on Using the Flash

When using the flash at a wide-angle zoom position, reflections from dust particles in the air may appear as bright spots in pictures. To reduce these reflections, set the flash to 🚫 (Off) or zoom in on the subject.

🔍 The Flash Indicator

The flash indicator shows flash status when the shutter-release button is pressed halfway.

- **On:** Flash will fire when picture is taken.
- **Blinks:** Flash charging. Wait a few seconds and try again.
- **Off:** Flash will not fire when picture is taken.

When pictures are taken using the low batteries, the monitor displays will turn off until the flash is fully charged.



🔍 The Flash Mode Setting

In 📷 (auto), high-sensitivity shooting, **P**, and **M** modes, the default setting is 🔋AUTO (auto).

The flash mode setting modified in 📷 (auto) mode returns to 🔋AUTO (auto) when the camera is turned off, unless a picture is taken with 🔋👁️ (auto with red-eye reduction) enabled. Adjustments to the flash mode setting applied in any scene mode are cancelled and these settings return to their default values whenever another shooting mode is selected or the camera is turned off.

🔍 Red-eye Reduction

This camera uses advanced red-eye reduction (“In-Camera Red-Eye Fix”). The flash fires repeatedly at low intensity before the main flash, reducing red-eye. The camera then analyzes the picture; if red-eye is detected, the affected area will be processed to further reduce red-eye before the picture is saved. Note that because there is a slight lag between the shutter-release button being pressed and the picture being taken, this mode is not recommended when a quick shutter response is required. The time before the next picture can be taken also increases slightly. Advanced red-eye reduction may not produce the desired results in all situations. In extremely rare instances, areas not subject to red-eye may be affected by advanced red-eye reduction processing; in these cases, choose another mode and try again.

Shooting with the Self-timer

The camera is equipped with a ten-second and two-second timer for self-portraits. When using the self-timer, use of a tripod is recommended. Set **Vibration reduction** (ⓧ 105) to **Off** when using a tripod.

1 Press (self-timer).

The self-timer menu is displayed.

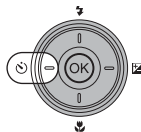

2 Use the multi selector to choose **10s** or **2s** and press .

10s (ten seconds): Suited for important occasions (such as weddings)

2s (two seconds): Suited for preventing camera shake

The mode selected for self-timer is displayed.

If a setting is not applied by pressing  within a few seconds, the selection will be cancelled.

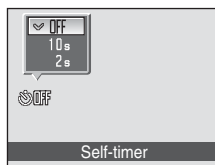

3 Frame the picture and press the shutter-release button halfway.

Focus and exposure will be set.

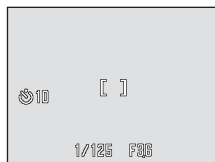

4 Press the shutter-release button the rest of the way down.

The self-timer starts and the number of seconds remaining until the shutter is released is displayed in the monitor. The self-timer lamp will blink. The lamp stops blinking one second before the picture is taken and remains lit until the shutter is released.

When the shutter is released, the self-timer turns off.

To stop the timer before a picture is taken, press the shutter-release button again.

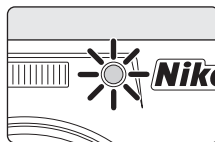
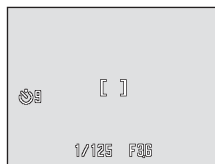

Choosing a Focus Mode

Choose a focus mode according to the subject and composition.

AF Autofocus

Camera automatically adjusts focus according to distance to subject. Use when the distance from subject to lens is 40 cm (1 ft. 4 in.) or more.

∞ Infinity

Use when shooting distant scenes through foreground objects such as windows or when shooting landscapes at ranges of 5 m (17 ft.) or more. Flash turns off automatically.

🌸 Macro close-up

Use for close-ups. If zoomed in or out until **🌸** icon displayed in the monitor turns green, camera can focus on objects as close as 10 cm (4 in.) to lens.

Setting the Focus Mode

1 Press **🌸** (focus mode).

The focus menu is displayed.

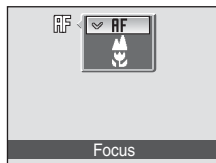
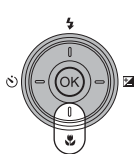

2 Use the multi selector to choose the desired focus mode and press **OK**.

The icon for the selected focus mode is displayed at the top of the monitor.

When **AF** (autofocus) is applied, **AF** is only displayed for five seconds.

If a setting is not applied by pressing **OK** within a few seconds, the selection will be cancelled.



🌸 Macro Close-up Mode

In macro close-up mode, the camera focuses continuously, even when the shutter-release button is not pressed halfway to lock focus.

However, in **S** (high sensitivity), **P**, and **M** modes, the current **Autofocus mode** setting (**88**) will be applied.

📎 The Focus Mode Setting

In **A** (auto), high-sensitivity shooting, **P**, and **M** modes, the default setting is **AF** (autofocus). The focus mode applied in **A** (auto) mode will be restored to its default setting when another shooting mode is selected or the camera is turned off. The focus mode applied in scene mode will be restored to its default setting when another shooting mode is selected or the camera is turned off.

Exposure Compensation

Exposure compensation is used to alter exposure from the value suggested by the camera to make pictures brighter or darker.

1 Press (exposure compensation).

The exposure compensation value will be displayed.

Exposure compensation is not available in **M** (manual) mode.

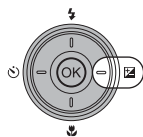

2 Press the multi selector or to adjust exposure.

The exposure compensation guide is displayed.

When the picture is too dark, adjust the exposure compensation in the positive (+) direction.

When the picture is too bright, adjust the exposure compensation in the negative (-) direction.

Exposure compensation can be set to values between -2.0 and +2.0 EV.



3 Press the shutter-release button to take a picture.

Repeat steps 2 and 3 to take a picture while adjusting exposure compensation values a little at a time.



4 Press to finalize the exposure compensation setting.

When an exposure compensation value other than **0.0** is applied, the value is displayed with the  icon in the monitor.

To cancel exposure compensation, select **0.0** before pressing , or follow steps 1 and 2 to select **0.0**.

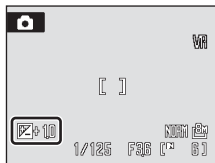

Exposure Compensation Value

Switching to another shooting mode or turning the camera off cancels the exposure compensation setting applied in  (auto) or scene mode and returns to **0.0**.

Using Exposure Compensation

The camera tends to lower exposure when the frame is dominated by brightly lit objects and to increase exposure when the frame is mostly dark. *Positive* compensation may therefore be required to capture the brilliancy of very bright objects that fill the frame (for example, sunlit expanses of water, sand, or snow) or when the background is much brighter than the main subject. *Negative* compensation may be called for when large areas of the frame contain very dark objects (for example, a swath of dark green leaves) or when the background is much darker than the main subject.













Scene Mode

Camera settings are automatically optimized for the selected scene type. Some scene types can be selected using only the mode dial, while others can easily be selected from the scene menu.

Mode Dial Scenes

 Portrait	 Landscape	 Night portrait
--	---	--

Scene Menu Scenes

 Party/indoor	 Sports	 Backlight
 Beach/snow	 Close-up	 Panorama assist
 Sunset	 Museum	 Voice recording*
 Dusk/dawn	 Fireworks show	
 Night landscape	 Copy	



* See "Voice Recordings" (📖 58).

Image Quality and Image Size

When **MENU** is pressed in a scene mode, the scene menu is displayed and the **Image quality** (📖 76) and **Image size** (📖 77) settings can be adjusted. Changes made to these settings apply to all shooting modes.

Shooting in Scene Modes

(Portrait), (Landscape), and (Night Portrait) Modes

- 1 Rotate the mode dial to  (portrait),  (landscape), or  (night portrait).

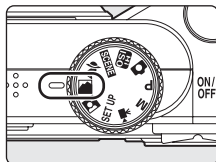

- 2 Frame the subject and take the picture.



Other Scene Modes

- 1 Rotate the mode dial to **SCENE**.

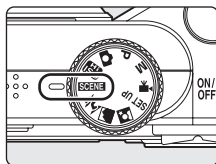

- 2 Press **MENU** to display the scene menu screen, choose the desired scene with the multi selector and press **OK**.

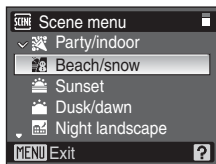
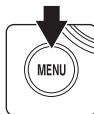

- 3 Frame the subject and take the picture.



Features

Portrait

Use this mode for portraits in which the main subject stands out clearly. Portrait subjects exhibit smooth, natural-looking skin tones.

- The camera detects and focuses on a face looking toward the camera (Shooting with Face-Priority →  87).
- If the camera detects multiple faces, the camera focuses on the face closest to the camera.
- If no face is recognized, the camera will focus on the subject in the center focus area.
- Digital zoom is not available.



* Other settings can be selected.

Landscape











Use this mode for vivid landscapes and cityscapes.

- Camera focuses at infinity. While the shutter-release button is pressed halfway, the focus area, or focus indicator, glows green. Note, however, that close subjects may not be in focus.



* Other settings can be selected.

Icons Used for Descriptions

The following icons are used for descriptions in this section: , flash mode ( 28); , self-timer ( 30); , focus mode ( 31); , exposure compensation ( 32); , AF-assist illumination ( 105).

Scene Mode Settings

Adjustments to the flash mode setting, self-timer setting, focus mode setting, and exposure compensation value applied in any scene mode are cancelled and these settings return to their default values whenever another shooting mode is selected or the camera is turned off.

Scene Mode

Night portrait



Use this mode to achieve a natural balance between the main subject and background lighting in portraits taken at night.

- The camera detects and focuses on a face looking toward the camera (Shooting with Face-Priority → 87).
- If the camera detects multiple faces, the camera focuses on the face closest to the camera.
- If no face is recognized, the camera will focus on the subject in the center focus area.
- Digital zoom is not available.



¹ Fill flash with slow sync and red-eye reduction will be selected.

² Other settings can be selected.

Party/indoor

Captures the effects of candlelight and other indoor background lighting.

- Camera focuses on subject in center of frame.
- Hold the camera steadily as pictures are easily affected by camera shake. When shooting under low lighting, use of a tripod is recommended. Set **Vibration reduction** (105) to **Off** when using a tripod.



¹ The flash mode may be switched to slow sync with red-eye reduction. Other settings can be selected.

² Other settings can be selected.

Beach/snow

Captures the brightness of such subjects as snowfields, beaches, or sunlit expanses of water.

- Camera focuses on subject in center of frame.



¹ Other settings can be selected.

² Also (macro close-up) can be selected.

: For those scene modes with , use of a tripod is recommended. Set **Vibration reduction** (105) to **Off** when using a tripod.

: Pictures taken in scene modes utilizing may be processed to reduce noise and therefore take longer to record.

Sunset



Preserves the deep hues seen in sunsets and sunrises.

- Camera focuses at infinity. While the shutter-release button is pressed halfway, the focus area, or focus indicator, glows green. Note, however, that close subjects may not be in focus.



* Other settings can be selected.

Dusk/dawn



Preserves the colors seen in the weak natural light before sunrise or after sunset.

- Camera focuses at infinity. While the shutter-release button is pressed halfway, the focus area, or focus indicator, glows green. Note, however, that close subjects may not be in focus.



* Other settings can be selected.

Night landscape







Slow shutter speeds are used to produce stunning night landscapes.

- Camera focuses at infinity. While the shutter-release button is pressed halfway, the focus area, or focus indicator, glows green. Note, however, that close subjects may not be in focus.



* Other settings can be selected.

: For those scene modes with , use of a tripod is recommended. Set **Vibration reduction** ( 105) to **Off** when using a tripod.

: Pictures taken in scene modes utilizing  may be processed to reduce noise and therefore take longer to record.

Scene Mode

Sports

Use this mode for dynamic action shots that freeze the action in a single shot and record motion in a series of pictures.







- Until the shutter-release button is pressed halfway to set focus, the camera focuses continuously.
- While the shutter-release button is held down, the camera shoots at a rate of about 2.0 frames per second (fps) when image quality is set to Normal and image size is set to  (3,264 × 2,448). This rate is maintained for up to 4 pictures. Focus, exposure, and white balance are fixed at values determined with the first shot in each series.
- The maximum frame rate with continuous shooting may vary depending upon the current image mode setting and the memory card used.
- Slower shutter speed may not be available.
- Camera focuses on subject in center of frame.



* Other settings can be selected.

Close-up

Photograph flowers, insects and other small objects at close range.



-  (macro close-up) is selected for focus mode ( 31) and the camera automatically zooms to the position at the closest distance at which the camera can focus.
- The camera can focus at distances as close as 10 cm (4 in.) at the wide-angle zoom position at which  glows green.
- The closest distance at which the camera can focus varies depending upon zoom position.
- **AF area mode** is set to **Manual** ( 86). When  is pressed, camera focuses on subject in active focus area.
- Until the shutter-release button is pressed halfway to set focus, the camera focuses continuously.
- As pictures are easily affected by camera shake, check the **Vibration reduction** ( 105) setting and hold the camera steadily.



* Other settings can be selected. Note that the flash may be unable to light entire subject at distances of less than 40 cm (1 ft. 4 in.)

Museum

Use indoors where flash photography is prohibited (for example, in museums and art galleries) or in other settings in which you do not want to use the flash.

- Camera focuses on subject in center of frame.
- **BSS** (Best Shot Selector) ( 85) is used when shooting.
- As pictures are easily affected by camera shake, check the **Vibration reduction** ( 105) setting and hold the camera steadily.
- Slower shutter speed may not be available.



¹ Other settings can be selected.

² Also  (macro close-up) can be selected.

🔦 Fireworks show



Slow shutter speeds are used to capture the expanding burst of light from a firework.

- Camera focuses at infinity. While the shutter-release button is pressed halfway, the focus indicator (📷 6) glows green. Note, however, that close subjects may not be in focus.



📄 Copy

Provides clear pictures of text or drawings on a white board or in print.

- Camera focuses on subject in center of frame.
- Use 🌸 (macro close-up) mode (📷 31) in focus mode with this mode to focus at short ranges.
- Colored text and drawings may not show up well.

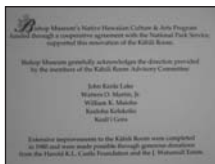

¹ Other settings can be selected.

² Also 🌸 (macro close-up) can be selected.

📷 Backlight

Use when light is coming from behind your subject, throwing features or details into shadow. The flash fires automatically to “fill in” (illuminate) shadows.

- Camera focuses on subject in center of frame.



* Other settings can be selected.

📷: For those scene modes with 📷, use of a tripod is recommended. Set **Vibration reduction** (📷 105) to **Off** when using a tripod.

☰ Panorama assist



Use when taking a series of pictures that will later be joined to form a single panorama using the supplied Panorama Maker software.

- Camera focuses on subject in center of frame.



* Other settings can be selected.

Shooting Pictures for a Panorama

The camera focuses on the subject in the center of the frame. Use a tripod for best results. Set **Vibration reduction** (📷 105) to **Off** when using a tripod to stabilize the camera during shooting.

- 1 Use the multi selector to choose ☰ **Panorama assist** in the scene menu and press **OK**.

The panorama direction icon (⇨) is displayed to show the direction in which pictures will be joined.

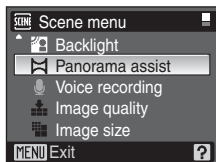

- 2 Use the multi selector to choose the direction and press **OK**.

Select how pictures will be joined together in the completed panorama; right (⇨), left (⇦), up (⇧) or down (⇩).

The yellow panorama direction icon (⇨⇨) points in the selected direction and becomes the white panorama direction icon (⇨) when **OK** is pressed. Apply flash mode (📷 28), self-timer (📷 30), focus mode (📷 31) and exposure compensation (📷 32) settings with this step, if necessary. Press **OK** to reselect the direction.



3 Take the first picture.

The first picture is displayed in the first third of the monitor.



4 Take the second picture.

Compose the next picture so that it overlaps the first picture.

Repeat until you have taken the necessary number of pictures to complete the scene.

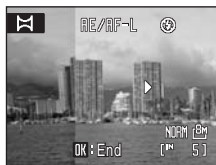

5 Press **OK** when shooting is completed.

The camera returns to step 2.



✓ Panorama Assist

Flash mode, self-timer, focus and exposure compensation settings cannot be adjusted after the first shot. Pictures cannot be deleted, nor can zoom, image quality (8 76), or image size (8 77) be adjusted until the series is finalized.

The panorama series is terminated if the camera enters standby mode with the auto off function (8 107) during shooting. Setting the time allowed to elapse before the auto off function is enabled to a longer setting is recommended.

🔒 Exposure Lock

AE/AF-L is displayed to indicate that focus, exposure, and white balance have been locked at the values applied with the first shot. All pictures taken in a panorama series have the same focus, exposure, and white balance settings.



💡 Panorama Maker

Install Panorama Maker from the supplied Software Suite CD. Transfer pictures to a computer (8 63) and use Panorama Maker (8 66) to join them in a single panorama.

🔍 More Information

See "Image/Sound File and Folder Names" (8 113) for more information.

Shooting in High-Sensitivity Shooting Mode

In high-sensitivity shooting mode, sensitivity is increased when shooting under low lighting, to reduce blurring caused by camera shake or subject movement, allowing you to capture the atmosphere of the scene. ISO sensitivity will be automatically increased to a maximum of 1600, depending upon the brightness of the subject.

1 Rotate the mode dial to **HI ISO**.

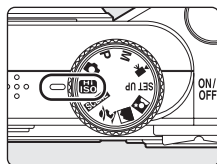

2 Frame the subject and take the picture.

When a face looking toward the camera is recognized, the camera will focus on the face surrounded by a double border by default.

When taking pictures of subjects other than people, or framing a subject with which no face is recognized, the camera automatically selects the focus area (one of nine) containing the subject closest to the camera.

See **AF area mode** (86) and “Shooting with Face-Priority” (87) for more information about face priority.

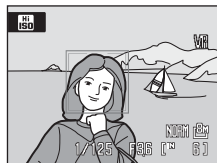

Notes on High-Sensitivity Shooting Mode

- This mode reduces effects of camera shake even for shooting under low lighting; however, when shooting without the flash, use of a tripod is recommended. Set **Vibration reduction** (105) to **Off** when using a tripod.
- Pictures taken in this mode may become somewhat grainy.
- Focus may not be precisely fixed in extremely dark places.
- When shooting under low lighting, processing to reduce noise may be performed automatically, except when **Continuous**, **BSS**, or **Multi-shot 16** is selected for **Continuous**, increasing the time required to save pictures.
- When shooting poorly-lit subjects with **Continuous**, **BSS**, or **Multi-shot 16** selected, slower shutter speeds may not be available.

Options Available in High-Sensitivity Shooting Mode

- Settings can be changed for flash mode (28), self-timer (30), focus mode (31) and exposure compensation (32).
- Pressing **MENU** in high-sensitivity shooting mode allows you to change the settings for all options in shooting menu (except ISO sensitivity) (75).

P (Programmed Auto) Mode

The camera automatically sets shutter speed and aperture.

Adjust shooting menu settings such as white balance and ISO sensitivity, as well as the continuous shooting mode.

- 1 Rotate the mode dial to **P**.

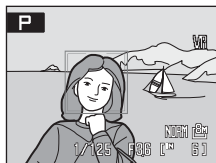
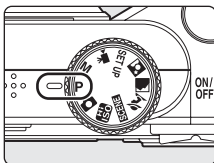

- 2 Adjust settings to suit the subject or your creative intent.

Press **MENU** and adjust shooting menu settings (📷 75).

Adjust the flash mode (📷 28), self-timer (📷 30), focus mode (📷 31), and exposure compensation (📷 32) settings.

- 3 Frame the subject and take the picture.

When a face looking toward the camera is recognized, the camera will focus on the face surrounded by a double border by default.



When taking pictures of subjects other than people, or framing a subject with which no face is recognized, the camera automatically selects the focus area (one of nine) containing the subject closest to the camera.

See **AF area mode** (📷 86) and “Shooting with Face-Priority” (📷 87) for more information about face priority.

✔ Noise Reduction

When shooting under low lighting, processing to reduce noise may be performed automatically, except when **Continuous**, **BSS**, or **Multi-shot 16** is selected for **Continuous**, increasing the time required to save pictures.

✔ Note on P (Programmed Auto) Mode

When shooting poorly-lit subjects with **Continuous**, **BSS**, or **Multi-shot 16** selected, slower shutter speeds may not be available.

M (Manual) Mode

Choose this mode to control exposure with manual specification of shutter speed and aperture.

Adjust shooting menu settings such as white balance and ISO sensitivity, as well as the continuous shooting mode.

- 1 Rotate the mode dial to **M**.

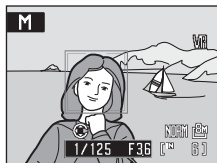
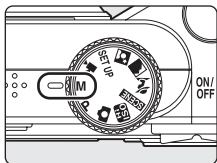

- 2 Press the multi selector **▶** to activate the shutter speed setting.

The active setting switches between shutter speed and aperture each time the multi selector **◀▶** is pressed.

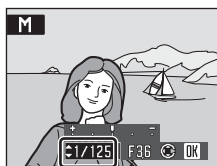

Shutter speed

- 3 Press the multi selector **▲** or **▼** to choose a shutter speed between 1/1,200 s and 8 s.

When adjusting aperture or shutter speed, the degree of deviation from the exposure value measured by the camera is displayed in the exposure display.

The degree of deviation in the exposure display is shown in EVs (-2 to +2 EV in increments of 1/3 EV). A display similar to that illustrated at right indicates that the picture will be overexposed by 1 EV (+1).

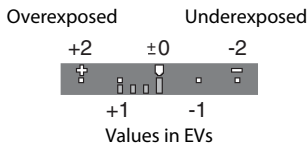
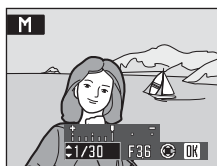

- 4 Press the multi selector **▶** to activate the aperture setting.

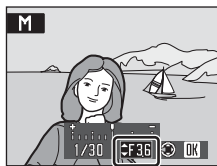

Aperture

5 Press the multi selector ▲ or ▼ to choose one of two aperture values.

Repeat steps 2 to 5 to modify shutter speed and aperture settings until the desired exposure is achieved.

Press **OK** to apply the settings.

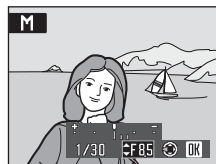

6 Frame the subject and take the picture.

When a face looking toward the camera is recognized, the camera will focus on the face surrounded by a double border by default.



When taking pictures of subjects other than people, or framing a subject with which no face is recognized, the camera automatically selects the focus area (one of nine) containing the subject closest to the camera.

See **AF area mode** (F 86) and "Shooting with Face-Priority" (F 87) for more information about face priority.

✓ Notes on Slow Shutter Speed

- At shutter speeds slower than 1/4 s, noise reduction is automatically performed, except when **Continuous**, **BSS**, or **Multi-shot 16** is selected for **Continuous**, increasing the time required to save pictures.
- When shooting poorly-lit subjects with **Continuous**, **BSS**, or **Multi-shot 16** selected, slower shutter speeds may not be available.

✓ Functions Available in M (Manual) Mode

- Flash mode (F 28) and focus mode (F 31) can be adjusted, and self-timer (F 30) can be enabled.
- Press **MENU** in **M** (manual) mode to adjust shooting menu settings (F 75).

Changing Camera Settings

Use the multi selector to change settings as follows.

When **Manual** is selected for **AF area mode** (F 86)

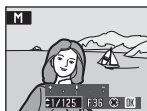

Switching between shutter speed and aperture: ◀ or ▶

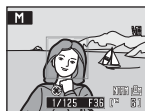

Flash mode : ▲
Self-timer : ◀
Focus mode : ▼



Selecting a focus area:
▲, ▼, ◀, or ▶

M (Manual) Mode

✔ Note on ISO Sensitivity

Even at an **ISO sensitivity** (83) setting of **Auto** (default setting), sensitivity is set to ISO 80.

🔍 Exposure

The adjustment of shutter speed and aperture to achieve the intended brightness (exposure) is known as “adjusting exposure.” Varying shutter speed allows you to freeze or blur subject movement, even while maintaining the same exposure.

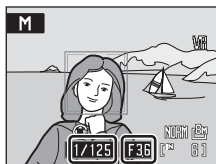

Shutter speed — Aperture





Fast shutter speed:
1/1,000 s











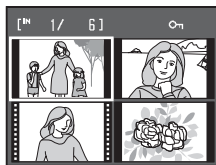



Slow shutter speed:
1/30 s

Viewing Multiple Pictures: Thumbnail Playback



Press **W** () in full-frame playback mode ( 26) to display pictures in “contact sheets” of thumbnail images.

The following operations can be performed while thumbnails are displayed.



To	Use	Description	
Choose pictures		Press the multi selector ▲, ▼, ◀, or ▶ to choose pictures.	11
Change number of pictures displayed	W () T ()	When W () is pressed, display picture thumbnails in the following order: 4 → 9 → 16 When T () is pressed, the number of thumbnails changes reversely.	–
Cancel thumbnail playback		Press  .	26
Switch to shooting mode	 	Press  or the shutter-release button to switch to the mode selected with the mode dial.	26

Thumbnail Playback Mode Display

When pictures included in a print set ( 73) and protected pictures ( 94) are displayed in thumbnail playback mode, the icons shown at right are displayed with them.

Movies are displayed as film frames.

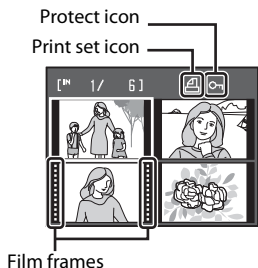

Taking a Closer Look: Playback Zoom

Pressing **T** (Q) during full-frame playback mode (26) enables the quick playback zoom function, which zooms the current picture in 3x with the center of the picture displayed.

The guide at lower right shows which portion of the picture is enlarged. Press the multi selector ▲, ▼, ◀, or ▶ to move to other areas of the picture not visible in the monitor.

The magnification ratio can be changed further by operating the zoom buttons. The zoom ratio will be displayed in the monitor, and can be increased up to 10x.



The following operations can be performed while pictures are zoomed in.

To	Use	Description	26
Zoom in	T (Q)	Press T (Q).	-
Zoom out	W (Z)	Press W (Z). When the magnification ratio reaches 1x, the monitor returns to full-frame playback mode.	-
View other areas of picture		Press the multi selector ▲, ▼, ◀ or ▶ to move to areas of the picture not visible in the monitor.	11
Switch to full-frame playback	OK	Press OK .	26
Crop picture	MENU	Press MENU to crop current picture to contain only the portion visible in the monitor.	51
Switch to shooting mode		Press or the shutter-release button to switch to the mode selected with the mode dial.	26

Editing Pictures

Use the COOLPIX P60 to edit pictures in-camera and store them as separate files (📷 113). The editing features described below are available.

Editing function	Description
D-Lighting (📷 50)	Create a copy of the current picture with enhanced brightness and contrast, brightening dark portions of the picture.
Crop (📷 51)	Enlarge the image or refine the composition and create a copy containing only the portion visible in the monitor.
Small picture (📷 52)	Create a small copy of pictures suitable for use on web pages or as e-mail attachments.

Picture Editing

- Pictures taken at an image size of 3248 (3,264 × 2,176) and 3264 (3,264 × 1,836) (📷 77) cannot be modified using the D-Lighting, crop, or small picture function.
- The COOLPIX P60's editing functions may not be available for pictures taken with non-COOLPIX P60 digital cameras.
- If a copy created using the COOLPIX P60 is viewed on a different digital camera, the picture may not be displayed or may not be transferred to a computer.
- Editing functions are not available when there is not enough free space in the internal memory or on the memory card.

Restrictions on Picture Editing

(✓: available, -: not available)

1st editing	2nd editing		
	D-Lighting	Crop	Small picture
D-Lighting	-	✓	✓
Crop	-	-	-
Small picture	-	-	-

- Pictures cannot be edited twice with the same editing function.
- The D-Lighting should be done first while the restricted use of combination exists.

Original Pictures and Edited Copies

- Copies created with editing functions are not deleted if the original pictures are deleted. The original pictures are not deleted if copies created with editing functions are deleted.
- Edited copies are stored with the same recording date and time as the original.
- Edited copies are not marked for printing (📷 73) or protecting (📷 94) as the original.

Enhancing Brightness and Contrast: D-Lighting

D-Lighting can be used to create copies with enhanced brightness and contrast, brightening dark portions of a picture. Enhanced copies are stored as separate files.

- 1 Select the desired picture from full-frame (📷 26) or thumbnail (📷 47) playback mode and press **MENU**.

The playback menu is displayed.

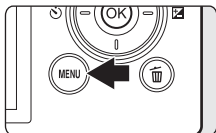

- 2 Use the multi selector to choose **D-Lighting** and press **OK**.

The original version will be shown on the left and the edited version will be shown on the right.



- 3 Choose **OK** and press **OK**.

A new copy with enhanced brightness and contrast is created.

To cancel D-Lighting, choose **Cancel** and press **OK**.

D-Lighting copies can be recognized by the 📷 icon displayed during playback.



More Information

See "Image/Sound File and Folder Names" (📷 113) for more information.

Creating a Cropped Copy: Crop



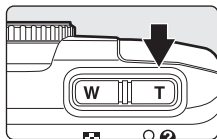

This function is only available when **MENU**  is displayed in the monitor with playback zoom ( 48) enabled. Cropped copies are stored as separate files.

- 1 Press **T** () in full-frame playback mode to zoom in on the image.



- 2 Refine copy composition.

Press **T** or **W** to adjust the zoom ratio.

Press the multi selector , , , or  to scroll the picture until only the portion you want to copy is visible in the monitor.



- 3 Press **MENU**.

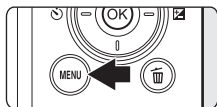

- 4 Use the multi selector to choose **Yes** and press .



A new picture, containing only the portion visible in the monitor, is created.

To cancel creating a cropped copy, choose **No**.



Depending on the size of the original picture and the zoom ratio in effect at the time the copy was created, the camera will automatically select one of the following image size settings for cropped copies (unit: pixels).

-  3,264 × 2,448
-  2,592 × 1,944
-  2,272 × 1,704
-  2,048 × 1,536
-  1,600 × 1,200
-  1,280 × 960
-  1,024 × 768
-  640 × 480
-  320 × 240
-  160 × 120



Cropped copies created at an image size setting of **320×240** or **160×120** are displayed with a gray background in playback mode, and the small picture indicator,  or , is displayed at left in the monitor.



More Information

See "Image/Sound File and Folder Names" ( 113) for more information.

Resizing Pictures: Small Picture

Create a small copy of the current picture. Small copies are stored as JPEG files with a compression ratio of 1:16. The following sizes are available.

Option	Description
 640×480	Suited to television playback.
 320×240	Suited to display on web pages.
 160×120	Suitable for e-mail attachments.

- 1 Select the desired picture from full-frame () 26) or thumbnail () 47) playback mode and press **MENU**.

The playback menu is displayed.

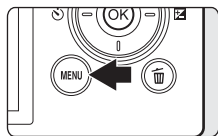

- 2 Use the multi selector to choose **Small pic.** and press **OK**.

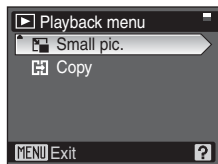

- 3 Choose the desired copy size and press **OK**.

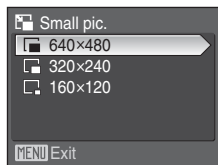

- 4 Choose **Yes** and press **OK**.

A new, smaller copy is created.

To cancel creating a small copy, choose **No**.

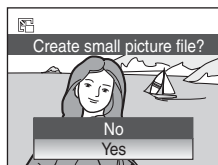

The copy is displayed with a gray background.



More Information

See "Image/Sound File and Folder Names" () 113) for more information.

Voice Memos: Recording and Playback

Use the camera's built-in microphone to record voice memos for pictures marked with **OK** :  in full-frame playback mode ( 26).

Recording Voice Memos

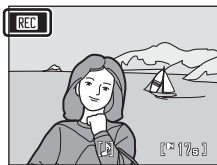
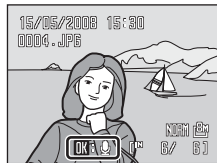
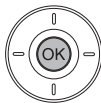

A voice memo, up to 20 seconds in length, will be recorded while **OK** is pressed down.

- Do not touch the built-in microphone during recording.
- During recording, **REC** and  blink.





Playing Voice Memos

Press **OK** while a picture is displayed in full-frame playback mode to play voice memo. Playback ends when the voice memo ends or **OK** is pressed again.

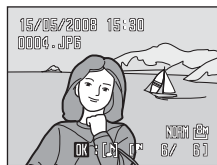
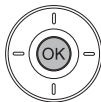
- Pictures with voice memos can be recognized by the **OK** :  icon.
- Use the zoom buttons, **T** () and **W** () to adjust playback volume.



Deleting Voice Memos

Select a picture with a voice memo and press . Use the multi selector to choose  and press **OK**. Only the voice memo will be deleted.



Voice Memos

- When a picture with a voice memo attached is deleted, both the picture and its voice memo are deleted.
- If a voice memo already exists for the current picture, it must be deleted before a new voice memo can be recorded.
- The COOLPIX P60 cannot be used to attach voice memos to pictures taken with cameras other than the COOLPIX P60.

More Information

See "Image/Sound File and Folder Names" ( 113) for more information.

Recording Movies

To shoot movies with sound recorded via the built-in microphone, follow the steps below.

1 Rotate the mode dial to .

Exposure count display shows total maximum length of movie that can be recorded.

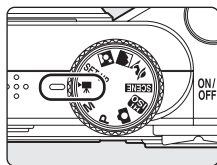

2 Press the shutter-release button all the way down to start recording.



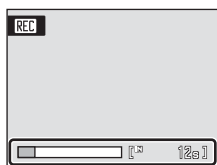

Camera focuses on the subject in the center focus area.

A progress bar at the bottom of the monitor shows the amount of recording time remaining.



To end recording, press the shutter-release button all the way down a second time.

Recording Movies

- Focus mode ( 31) and exposure compensation ( 32) are available in all modes. Flash mode ( 28) and self-timer ( 30) cannot be used.
- Focus mode and exposure compensation settings cannot be applied or changed while movies are being recorded. Apply or change settings as necessary before movie recording begins.
- Optical zoom cannot be adjusted once movie recording begins. Digital zoom cannot be applied before movie recording begins. However, digital zoom (up to 2x) can be applied while movies are being recorded.

Changing Movie Settings

Movie options, **Autofocus mode**, and **Electronic VR** settings can be changed in the movie menu ( 55).





The Movie Menu

Movie options, **Autofocus mode** (📷 56), and **Electronic VR** (📷 56) settings can be changed from the movie menu.





Press **MENU** in movie mode to display the movie menu and use the multi selector to modify and apply settings.

Selecting Movie Options

The movie menu offers the options shown below.

Option	Image size and frame rate
 TV movie 640★	Image size: 640 × 480 pixels Frame rate: 30 frames per second
 TV movie 640 (default setting)	Image size: 640 × 480 pixels Frame rate: 15 frames per second
 Small size 320★	Image size: 320 × 240 pixels Frame rate: 30 frames per second
 Small size 320	Image size: 320 × 240 pixels Frame rate: 15 frames per second

Movie Options and Maximum Movie Length and Frames

Option	Internal memory (approx. 12 MB)	Memory card (256 MB)
 TV movie 640★	6 s	Approx. 2 m 40 s
 TV movie 640 (default setting)	14 s	Approx. 5 m 15 s
 Small size 320★	29 s	Approx. 10 m 10 s
 Small size 320	58 s	Approx. 19 m 55 s



* Movies can be as long as free space in the internal memory or on the memory card allows. All figures are approximate. Maximum movie length or frames varies with make of memory card. The maximum file size for movies is 2 GB. A maximum movie length of up to 2 GB is displayed, even if the memory card has a capacity greater than 4 GB.

More Information

See "Image/Sound File and Folder Names" (📷 113) for more information.

Autofocus Mode

Choose how the camera focuses in movie mode.

Option	Description
 Single AF (default setting)	Camera focuses when shutter-release button is pressed halfway and locks at this position during shooting.
 Full-time AF	Camera focuses continuously until focus is acquired and locked. To prevent sound of camera focusing from interfering with recording, use of Single AF is recommended.

Electronic VR

Enable or disable electronic VR for movie recording.

Option	Description
 On (default setting)	Reduce the effects of camera shake in all movie modes.
Off	Electronic VR is not enabled.

At settings other than **Off**, the electronic vibration reduction icon is displayed ( 6).

Setting for Electronic VR

When **TV movie 640** ★ or **Small size 320** ★ is selected for **Movie options** ( 55), or **Full-time AF** for **Autofocus mode**, **Electronic VR** is set to **Off**.

Selecting **TV movie 640** or **Small size 320** for **Movie options**, or selecting **Single AF** for **Autofocus mode** restores the original **Electronic VR** setting.

Movie Playback

In full-frame playback mode (🗑️ 26), movies are recognized by movie options (🗑️ 55) icons. To play a movie, display it in full-frame playback mode and press **OK**.

Use the zoom buttons, **T** (🔍) and **W** (🔲), to adjust playback volume.

Press the multi selector ◀ or ▶ to choose a control at the top of the monitor, then press **OK** to perform the selected operation. The following operations are available.

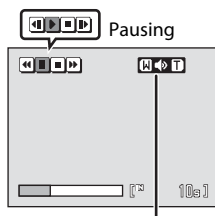
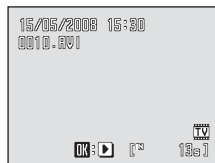

Volume indicator
During playback

To	Press	Description	
Rewind	⏮	Rewind movie. Playback resumes when OK is released.	
Advance	⏭	Advance movie. Playback resumes when OK is released.	
Pause	⏸	Pause playback. While paused, use the multi selector to advance or rewind the movie. The following operations can be performed while playback is paused.	
		⏮	Rewind movie by one frame. Rewind continues while OK is pressed.
		⏭	Advance movie by one frame. Advance continues while OK is pressed.
		▶	Resume playback.
End	⏹	End playback and return to full-frame playback.	

Deleting Movie Files

Press 🗑️ when displayed in full-frame playback mode (🗑️ 26), or when selected in thumbnail playback mode (🗑️ 47). A confirmation dialog is displayed.

To delete the movie, select **Yes** and press **OK**. To exit without deleting the movie, select **No** and press **OK**.

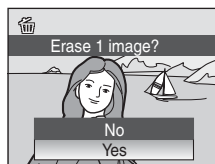

Making Voice Recordings

Audio voice recordings can be recorded over the built-in microphone and played back over the built-in speaker.

- 1 Rotate the mode dial to **SCENE**.

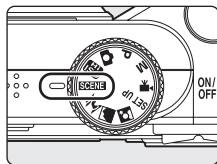

- 2 Press **MENU** to display the scene menu, use the multi selector to choose  (voice recording), and press **OK**.

The length of recording that can be made will be displayed.

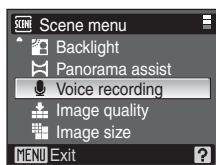

- 3 Press the shutter-release button all the way down to start recording.

If no operations are performed for about 30 seconds after voice recording begins, the camera's auto off function is enabled and the monitor will turn off.

See "Operations During Recording" ( 59) for more information.

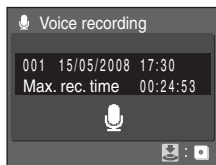

- 4 Press the shutter-release button all the way down a second time to end recording.









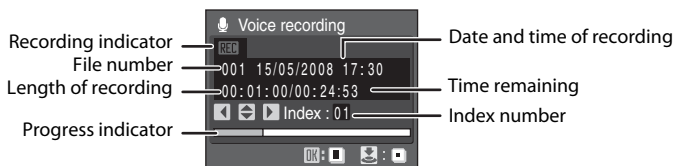

Recording will end automatically if the internal memory or memory card becomes full, or after five hours.

More Information

See "Image/Sound File and Folder Names" ( 113) for more information.



Operations During Recording



To	Press	Description
Reactivate the monitor		If the monitor has turned off, press  to reactivate.
Pause/resume recording		Press  to pause or resume recording.
Create index*		During recording, press the multi selector  ,  ,  , or  to create index. Indexes make it easy to locate desired portions of a recording. Start of recording is index number 01; other numbers that follow are assigned in ascending order each time the multi selector is pressed, up to index number 98.
End recording		Press the shutter-release button all the way down a second time to end recording.

* The copied files can be played back using QuickTime or any other WAV-compatible audio player. Note that index points created with the camera cannot be used when voice recordings are played back on computers.

Playing Voice Recordings

- 1 Press  in the voice recording screen ( 58, step 3).



- 2 Use the multi selector to choose the desired sound file and press .

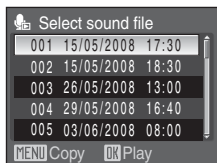

The selected sound file will be played back.



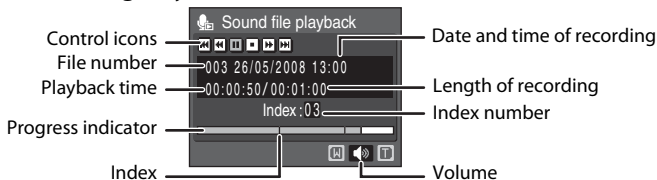







Operations During Playback





Use the zoom buttons, **T** () and **W** (), to adjust playback volume.

Playback controls appear at the top of the monitor. Press the multi selector  or  to choose a control, then press  to perform the selected operation. The following operations are available.

To	Press	Description
Rewind		Rewind voice recording. Playback resumes when  is released.
Advance		Advance voice recording. Playback resumes when  is released.
Skip to previous index		Skip to previous index.
Skip to next index		Skip to next index.
Pause	 	Pause playback. The following operations can be performed while playback is paused: Resume playback.
End		End playback and return to the sound file selection screen.

Deleting Sound Files

Press  during playback or after selecting a sound file from the select sound file screen. A confirmation dialog is displayed. To delete the file, select **Yes** and press . To exit without deleting the sound file, select **No** and press .

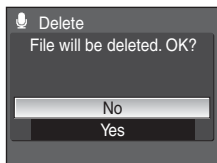



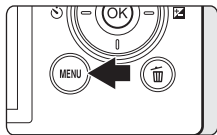

Copying Voice Recordings

Copy voice recordings between the internal memory and a memory card.
This option is available only when a memory card is inserted.

- 1** Press **MENU** in the select sound file screen (▶ 60, step 2).



- 2** Use the multi selector to choose the option and press **OK**.

-  : Copy recordings from internal memory to memory card
-  : Copy recordings from memory card to internal memory

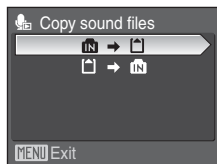



- 3** Choose the copy option and press **OK**.

Selected files: Proceed to step 4

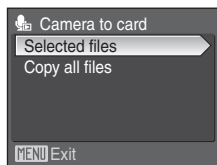
Copy all files: Proceed to step 5



- 4** Choose the desired file.

Press the multi selector  to select the file (✔). Press the multi selector  again to cancel the selection.

Multiple files can be selected.

Press **OK** to finalize file selection.

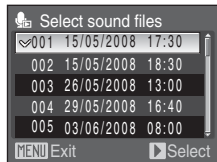

- 5** When a confirmation dialog is displayed, choose **Yes** and press **OK**.

Copying starts.

Voice Recordings

The COOLPIX P60 may be unable to play or copy sound files created with cameras other than the COOLPIX P60.

No sound file. Message

If there are no sound files stored on the memory card when  is pressed (▶ 60, step 1), the message **No sound file.** will be displayed. Press **MENU** to display the copy sound files screen, and copy the sound files stored in the camera's internal memory to the memory card.

Connecting to a TV

Connect the camera to a television using the supplied audio/video cable to play back pictures on the television.

1 Turn off the camera.

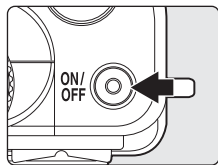

2 Connect the camera to the TV using the supplied audio/video cable.

Connect the yellow plug to the video-in jack on the TV, and the white plug to the audio-in jack.

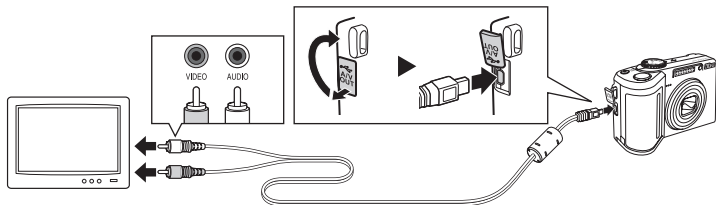

3 Tune the television to the video channel.

See the documentation provided with your television for details.

4 Hold down to turn on the camera.

The camera enters playback mode, and pictures recorded to the internal memory, or memory card, will be displayed on the television.

While connected to the TV, the camera monitor will remain off.

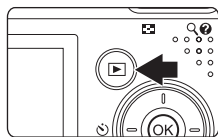

Connecting an Audio/Video Cable

When connecting the audio/video cable, be sure that the camera connector is oriented correctly. Do not use force when connecting the audio/video cable to the camera. When disconnecting the audio/video cable, do not pull the connector at an angle.

Video Mode

Be sure that the camera's video mode setting conforms to the standard used by your television. The video mode setting is an option set in the setup menu ( 96) > **Video mode** ( 108).

Connecting to a Computer

When the camera is connected to a computer using the supplied USB cable, pictures recorded with the camera can be copied (transferred) to the computer for storage using the Nikon Transfer software.

Before Connecting the Camera

Installing the Software

Before connecting the camera to a computer, software, including Nikon Transfer and Panorama Maker for creating panorama images, must be installed from the supplied Software Suite CD.

For more information on installing the software, refer to the *Quick Start Guide*.

Operating Systems Compatible with COOLPIX P60

Windows

Preinstalled versions of Windows Vista (32-bit Home Basic/Home Premium/Business/Enterprise/Ultimate editions), Windows XP Service Pack 2 (Home Edition/Professional)

If your computer is running Windows 2000 Professional, use a card reader or similar device to transfer pictures stored on the memory card to the computer (📷 65).

Macintosh

Mac OS X (versions 10.3.9 and 10.4.11)

Refer to the Nikon website for the latest information on operating system compatibility.

📌 Notes on Power Source

- When connecting the camera to a computer or printer, use batteries with adequate charge remaining to prevent the camera from turning off unexpectedly.
- To power the camera continuously for extended periods, use an AC Adapter EH-65A (available separately from Nikon) (📷 112). **Do not, under any circumstances, use another make or model of AC adapter.** Failure to observe this precaution could result in overheating or in damage to the camera.

Transferring Pictures from the Camera to a Computer

- 1 Start the computer to which Nikon Transfer has been installed.
- 2 Turn off the camera.
- 3 Connect the camera to the computer using the supplied USB cable.

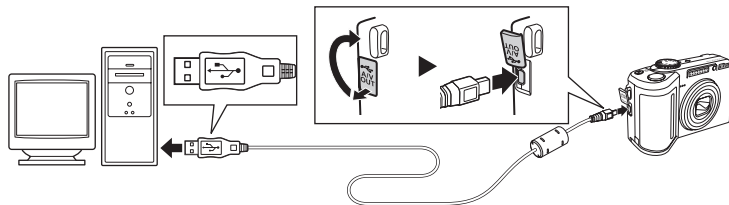

- 4 Turn on the camera.

The power-on lamp will light.

Windows Vista

When the AutoPlay dialog is displayed, select **Copy pictures to a folder on my computer using Nikon Transfer**. Nikon Transfer will start. To bypass this dialog in the future, check **Always do this for this device**:

Windows XP

When the AutoPlay dialog is displayed, select **Nikon Transfer Copy pictures to a folder on my computer** and click **OK**. Nikon Transfer will start. To bypass this dialog in the future, check **Always use this program for this action**.

Mac OS X

Nikon Transfer will start automatically if **Yes** was selected in the Auto-Launch setting dialog when Nikon Transfer was first installed.

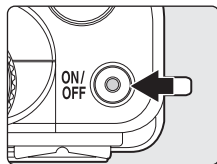

✓ Connecting the USB Cable

Be sure that the connectors are oriented correctly, and do not use force, to connect the USB cable. When disconnecting the USB cable, do not pull the connector at an angle.

Connection may not be recognized when the camera is connected to a computer via a USB hub.

5 Transfer pictures when Nikon Transfer has finished loading.

Click **Start Transfer** in Nikon Transfer. At the default setting, all pictures are transferred to the computer.

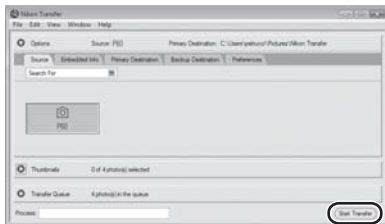

Start Transfer button

At the Nikon Transfer default settings, the folder to which pictures are transferred is automatically opened when transfer is complete.

For more information on using Nikon Transfer, refer to help information contained in Nikon Transfer.

6 Disconnect the camera when transfer is complete.

Turn the camera off and disconnect the USB cable.

For Users of Windows 2000 Professional

Use a card reader or similar device to transfer the pictures stored on the memory card to the computer.

If the memory card has a capacity greater than 2 GB, or is SDHC-compliant, the intended device must support these features of the memory card.

- At the Nikon Transfer default settings, Nikon Transfer will start automatically when a memory card is inserted into the card reader or similar device. See step 5 above to transfer pictures.
- Do not connect the camera to the computer. If the camera is connected to the computer, the **Found New Hardware Wizard** dialog will be displayed. Select **Cancel**, close the dialog, and disconnect the camera from the computer.
- To transfer pictures stored in the camera's internal memory to the computer, the pictures must first be copied to a memory card using the camera (61, 91, 95).



Using Standard OS Operations to Open Image/Sound Files

- Navigate to the folder on the computer's hard disk to which pictures were saved and open a picture in the viewer supplied with your operating system.
- Sound files copied to the computer can be played back using QuickTime or any other WAV-compatible audio player.



Panorama Creation with Panorama Maker

- Use a series of pictures taken using the **Panorama assist** option in scene mode (📷 40) to create a single panorama photo with Panorama Maker.
- Panorama Maker can be installed to a computer using the supplied Software Suite CD. After installation is complete, follow the procedure described below to start Panorama Maker.

Windows

Open **All Programs (Programs under Windows 2000)** from the **Start** menu > **ArcSoft Panorama Maker 4** > **Panorama Maker 4**.

Macintosh

Open Applications by selecting **Applications** from the **Go** menu, and double-click the **Panorama Maker 4** icon.

- For more information on using Panorama Maker, refer to the on-screen instructions and help information contained in Panorama Maker.



More Information

See "Image/Sound File and Folder Names" (📷 113) for more information.

Connecting to a Printer

Users of PictBridge-compatible (📷 128) printers can connect the camera directly to the printer and print pictures without using a computer.

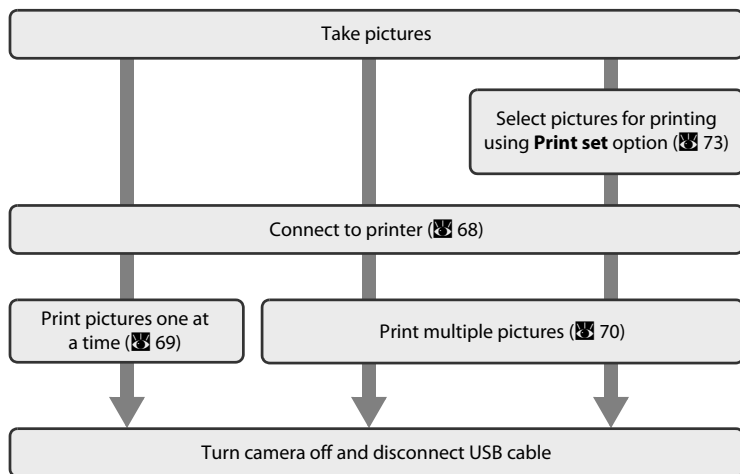

✔ Notes on Power Source

- When connecting the camera to a computer or printer, use batteries with adequate charge remaining to prevent the camera from turning off unexpectedly.
- To power the camera continuously for extended periods, use an AC Adapter EH-65A (available separately from Nikon) (📷 112). **Do not, under any circumstances, use another make or model of AC adapter.** Failure to observe this precaution could result in overheating or in damage to the camera.

🔍 Printing Pictures

In addition to printing pictures transferred to a computer from your personal printer and printing over a direct camera-to-printer connection, the following options are also available for printing pictures:

- Insert a memory card into a DPOF-compatible printer's card slot
- Take a memory card to a digital photo lab

For printing using these methods, specify the pictures and the number of prints each using your camera's print set menu (📷 73).

Connecting the Camera and Printer

- 1 Turn off the camera.

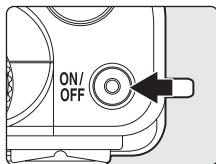

- 2 Turn on the printer.

Check printer settings.

- 3 Connect the camera to the printer using the supplied USB cable.

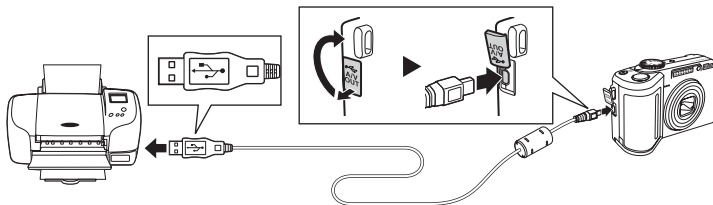

- 4 Turn on the camera.

When properly connected, the PictBridge startup screen ① will be displayed in the camera monitor. The print selection screen ② will be displayed next.

① will be displayed in the camera monitor. The print selection screen ② will be displayed next.

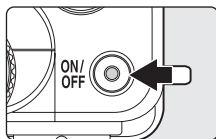

✓ Connecting the USB Cable

Be sure that the connectors are oriented correctly, and do not use force, to connect the USB cable. When disconnecting the USB cable, do not pull the connector at an angle.

Printing Pictures One at a Time

After connecting the camera to the printer correctly (▶ 68), print pictures by following the procedure below.

- 1** Press the multi selector ◀ or ▶ to choose the desired picture and press **OK**.

Press **W** (📄) to display 12 thumbnails, and **T** (🔍) to switch back to full-frame playback.

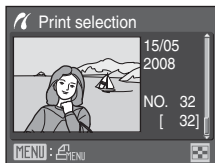

- 2** Choose **Copies** and press **OK**.

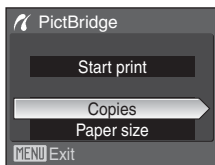

- 3** Choose the number of copies (up to nine) and press **OK**.

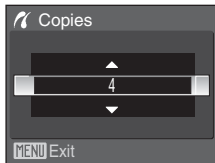

- 4** Choose **Paper size** and press **OK**.

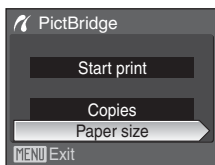

- 5** Choose the desired paper size and press **OK**.

To specify paper size using printer settings, choose **Default** in the paper size menu.

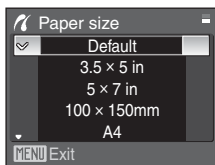

6 Choose **Start print** and press **OK**.

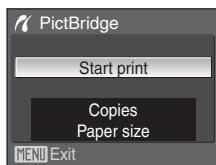

7 Printing starts.

Monitor display returns to that shown in step 1 when printing is complete.

To cancel before all copies have been printed, press **OK**.

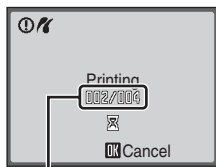

Current print/
total number of prints

Printing Multiple Pictures

After connecting the camera to the printer correctly (▶ 68), print pictures by following the procedure below.

1 When the print selection screen is displayed, press **MENU**.

The print menu is displayed.

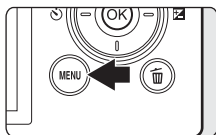

2 Use the multi selector to choose **Paper size** and press **OK**.

To exit to the print menu, press **MENU**.

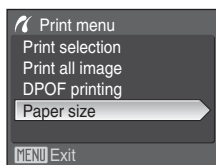

3 Choose the desired paper size and press **OK**.

To specify paper size using printer settings, choose **Default** in the paper size menu.

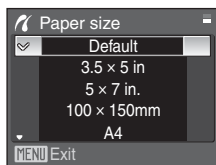

4 Choose **Print selection**, **Print all images** or **DPOF printing** and press **OK**.

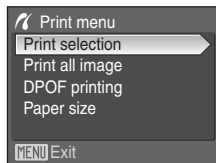

Print selection

Choose the pictures and number of copies (up to nine) of each.

Press the multi selector ◀ or ▶ to select pictures, and press ▲ or ▼ to set the number of copies for each.

Pictures selected for printing can be recognized by the check mark (✓) and the numeral indicating the number of copies to be printed. Pictures for which no copies have been specified will not be printed.

Press **T** (Q) to switch to full-frame playback.

Press **W** (E) to switch back to thumbnail display.

Press **OK** when setting is complete.

The menu shown at right will be displayed.

To print, choose **Start print** and press **OK**.

Choose **Cancel** and press **OK** to return to the print menu.

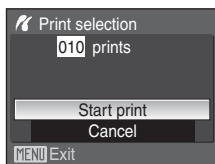

Print all images

All pictures stored in the internal memory, or on the memory card, are printed one at a time.

The menu shown at right will be displayed.

To print, choose **Start print** and press **OK**.

Choose **Cancel** and press **OK** to return to the print menu.

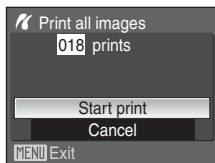

DPOF printing

Print pictures for which a print order was created in **Print set** (p. 73). The menu shown at right will be displayed. To print, choose **Start print** and press **OK**. Choose **Cancel** and press **OK** to return to the print menu.

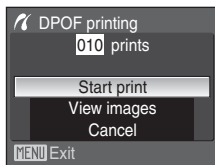

To view the current print order, choose **View images** and press **OK**. To print pictures, press **OK** again.



5 Printing starts.

Monitor display returns to the print menu (step 2) when printing is complete.

To cancel before all copies have been printed, press **OK**.

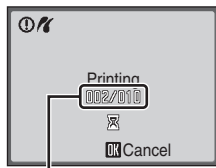

Current print/
total number of prints

Paper Size

The camera supports the following paper sizes: **Default** (the default paper size for the current printer), **3.5 × 5 in.**, **5 × 7 in.**, **100 × 150mm**, **4 × 6 in.**, **8 × 10 in.**, **Letter**, **A3**, and **A4**. Only sizes supported by the current printer will be displayed. To specify paper size using printer settings, choose **Default** in the paper size menu.

Creating a DPOF Print Order: Print Set

The **Print set** option in the playback menu is used to create digital “print orders” for printing on DPOF-compatible devices (128).

When the camera is connected to a PictBridge-compatible printer, pictures can be printed from the printer according to the DPOF print order you have created for pictures on the memory card. If the memory card is removed from the camera, you can create the DPOF print order for pictures in the internal memory and print pictures according to the DPOF print order.

1 Press **MENU** in playback mode.

The playback menu is displayed.

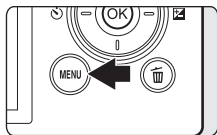

2 Use the multi selector to choose **Print set** and press **OK**.

The print set menu is displayed.

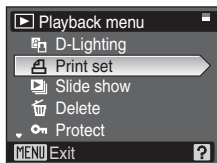

3 Choose **Select images** and press **OK**.

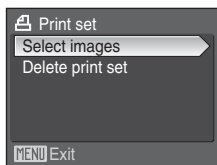

4 Choose the pictures and number of copies (up to nine) of each.

Press the multi selector ◀ or ▶ to select pictures, and press ▲ or ▼ to set the number of copies for each. Pictures selected for printing can be recognized by the check mark (☑) icon and the numeral indicating the number of copies to be printed. The pictures for which no copies have been specified will not be printed. Press **T** (Q) to switch to full-frame playback. Press **W** (R) to switch back to thumbnail display. Press **OK** when setting is complete.





5 Choose whether or not to also print shooting date and photo information.

Choose **Date** and press **OK** to print date of recording on all pictures in the print order.

Choose **Info** and press **OK** to print photo information (shutter speed and aperture) on all pictures in the print order.

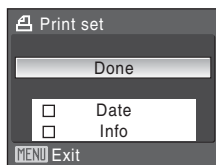
Choose **Done** and press **OK** to complete the print order and exit.



Pictures selected for printing are recognized by the  icon displayed during playback.

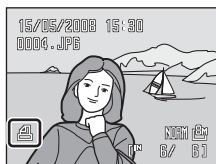

Notes on Printing Shooting Date and Photo Information

When the **Date** and **Info** options are enabled in the **Print set** menu, shooting date and photo information are printed on pictures when a DPOF-compatible ( 128) printer which supports printing of shooting date and photo information is used.

- Photo information cannot be printed when the camera is connected directly to a printer, via the supplied USB cable, for DPOF printing ( 72).
- **Date** and **Info** are reset each time the print set menu is displayed.

Deleting All Print Orders

Choose **Delete print set** in step 3 and press **OK**. Print orders for all pictures will be deleted.

Note on the Print Set Date Option

The date and time printed on pictures with DPOF printing, when **Date** in the print set menu is enabled, are those recorded with the picture as it was taken. Date and time printed using this option are not affected when the camera's date and time setting are changed from the setup menu after pictures are recorded.























Date Imprint

When date and time of recording are imprinted on pictures using the **Date imprint** option ( 103) in the setup menu, pictures with the date and time imprinted on them can be printed from printers that do not support printing of the date and time on pictures. Only the **Date imprint** date and time on pictures will be printed, even if **Print set** is enabled with **Date** selected in the print set screen.

Shooting Options: The Shooting Menu

The shooting menu of **P** and **M** modes, and high-sensitivity menu of high-sensitivity shooting mode, contain the following options.

	Image quality ¹	 76
Choose the image quality (compression ratio) of recorded pictures.		
	Image size ^{1, 3}	 77
Choose the image size of recorded pictures.		
	Optimize image ³	 79
Control contrast, sharpness, and saturation.		
	White balance ³	 81
Match white balance to the light source.		
	ISO sensitivity ^{2, 3}	 83
Control the camera's sensitivity to light.		
	Metering	 84
Choose how the camera meters exposure.		
	Continuous ³	 85
Select the option to take pictures one at a time, in a sequence, or with Best Shot Selector (BSS).		
	AF area mode ³	 86
Choose where the camera focuses.		
	Autofocus mode	 88
Choose how the camera focuses.		
	Flash exp. comp.	 89
Adjust flash level.		

¹ Settings can be applied from other shooting menus (except the movie menu).

² This setting cannot be set in the high-sensitivity menu.

³ See the information on restrictions that may apply to these settings ( 90).

Displaying the Shooting Menu and High-sensitivity Menu

Choose **P** (programmed auto), **M** (manual), or **HI ISO** (high sensitivity) by rotating the mode dial. Press **MENU** to display the shooting menu or high-sensitivity menu.

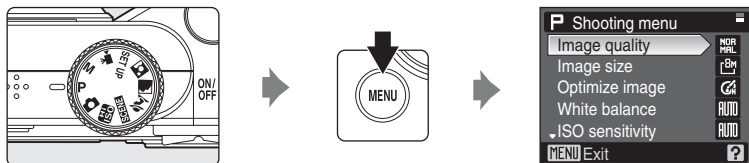

- The high sensitivity menu is displayed when **HI ISO** is selected by the mode dial.
- To return to the shooting mode from the shooting or high-sensitivity menu, press **MENU** or the shutter-release button.

Image Quality

Choose the amount of compression applied to pictures. Lower compression ratios result in higher quality pictures, but also larger file sizes, limiting the number of pictures that can be recorded.

FINE	Fine
	Fine quality images (compression ratio of 1:4), suitable for enlargement or high-quality prints.
MDR MFL	Normal (default setting)
	Normal image quality (compression of 1:8), suited to most applications.
BR SIC	Basic
	Basic image quality (compression of 1:16), suitable for pictures that will be distributed by e-mail or used in web pages.

Image quality is shown by an icon (📷 6, 7).

More Information

See "Number of Exposures Remaining" (📷 78) for more information.

Image Size

Choose the size of pictures in pixels for recording. Pictures taken at smaller sizes require less memory, making them suited to distribution by e-mail or the web. Conversely, the larger the image, the larger the size at which it can be printed or displayed without becoming noticeably “grainy,” limiting the number of pictures that can be recorded.





















Option	Description
 3264×2448 (default setting)	Good balance between file size and quality makes this the best choice in most situations.
 2592×1944	
 2048×1536	Smaller than  3264×2448 and  2592×1944 for recording more pictures.
 1600×1200	
 1280×960	
 1024×768	Record pictures suited to display on a computer monitor.
 640×480	Record pictures suited to display on a television, or to distribution via e-mail or the web.
 3264×2176	Record pictures with the same aspect ratio (3:2) as those taken with 35mm film cameras.
 3264×1836	Record pictures with the same aspect ratio (16:9) as wide-screen televisions.

Image size is shown by an icon ( 6, 7).

Number of Exposures Remaining

The following table lists the approximate number of pictures that can be stored in internal memory, and on a 256-MB memory card, at each combination of image quality (📷 76) and image size (📷 77) settings. Note that the number of pictures that can be stored will differ depending on the composition of the picture (due to JPEG compression). In addition, this number may differ depending on the make of memory card, even if the capacity for the memory card is the same.

Image size	Image quality	Internal memory (12 MB)	256 MB memory card ¹	Print size (printed at 300 dpi; cm/in.) ²
 3264x2448 (default setting)	Fine	3	Approx. 65	Approx. 28 × 21/10.8 × 8.1
	Normal	6	Approx. 135	
	Basic	11	Approx. 230	
 2592x1944	Fine	5	Approx. 110	Approx. 22 × 16/8.6 × 6.4
	Normal	10	Approx. 220	
	Basic	17	Approx. 355	
 2048x1536	Fine	8	Approx. 180	Approx. 17 × 13/6.8 × 5.1
	Normal	17	Approx. 350	
	Basic	27	Approx. 550	
 1600x1200	Fine	14	Approx. 295	Approx. 14 × 10/5.3 × 4
	Normal	27	Approx. 550	
	Basic	42	Approx. 855	
 1280x960	Fine	21	Approx. 440	Approx. 11 × 8/4.2 × 3.2
	Normal	40	Approx. 810	
	Basic	58	Approx. 1185	
 1024x768	Fine	33	Approx. 670	Approx. 9 × 7/3.4 × 2.5
	Normal	54	Approx. 1100	
	Basic	76	Approx. 1540	
 640x480	Fine	69	Approx. 1400	Approx. 5 × 4/2.1 × 1.6
	Normal	108	Approx. 2200	
	Basic	127	Approx. 2570	
 3264x2176	Fine	3	Approx. 75	Approx. 28 × 19/10.8 × 7.2
	Normal	7	Approx. 155	
	Basic	12	Approx. 255	
 3264x1836	Fine	4	Approx. 90	Approx. 27 × 15/10.6 × 6
	Normal	9	Approx. 180	
	Basic	14	Approx. 300	

¹ If the number of exposures remaining is 10,000 or more, the number of exposures remaining display shows **9999**.

² Print sizes are calculated by dividing the number of pixels by printer resolution (dpi) and multiplying by 2.54 cm (1 in.). However, at the same image size, pictures printed at higher resolutions will print smaller the size indicated, and those printed at lower resolutions will print larger than the size indicated.

Optimize Image

Optimize contrast, sharpening, and other settings according to how pictures will be used or the type of scene.



Normal (default setting)

Recommended in most situations.



Softer

Softens outlines, producing natural results suitable for portraits or retouching on a computer.



Vivid

Enhances saturation, contrast, and sharpness to produce vivid images with vibrant reds and greens.



More vivid

Maximizes saturation, contrast, and sharpness to produce crisp images with sharp outlines.



Portrait

Lowers contrast while lending natural texture and rounded feel to skin of portrait subjects.



Custom

Customize image optimization settings (▶ 80).



Black-and-white

Shoot photos in black-and-white.

At settings other than **Normal**, the indicator for the current optimize image setting is displayed during shooting (▶ 6).



Optimize Image

At settings other than **Custom** and **Black-and-white**, results are optimized for current shooting conditions and vary with exposure and the position of the subject in the frame. For consistent results over a series of photographs, select **Custom** and choose a setting other than **Auto** for **Contrast**, **Image sharpening**, and **Saturation**.

Customizing Image Enhancement Options: Custom

Select **Custom** to make separate adjustments to the following options.

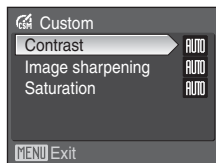

Contrast

Control contrast. Higher settings preserve detail in misty landscapes and other low-contrast subjects. Lower settings prevent loss of detail in highlights under harsh lighting or in direct sunlight. The default setting is **Auto**.

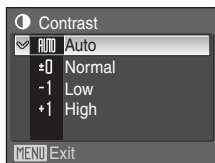
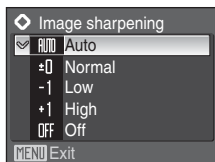

Image sharpening

Choose how much outlines are sharpened. Choose high settings for sharp outlines, low settings for softer outlines. The default setting is **Auto**.



Saturation

Control the vividness of colors. Choose **Enhanced** for more vivid colors, **Moderate** for less saturated colors. The default setting is **Auto**.

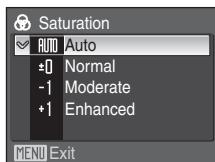

✔ Note on Image Sharpening

The effects of image sharpening cannot be previewed during shooting. Check results in playback mode.

WB White Balance

The color of light reflected from an object varies with the color of the light source. The human brain is able to adapt to changes in the color of the light source, with the result that white objects appear white whether seen in the shade, direct sunlight, or under incandescent lighting. Digital cameras can mimic this adjustment by processing images according to the color of the light source. This is known as “white balance.” For natural coloration, choose a white balance setting that matches the light source before shooting. Although the default setting, **Auto**, can be used under most types of lighting, you can apply the white balance setting suited to a particular light source to achieve more accurate results.

Auto (default setting)

White balance automatically adjusted to suit lighting conditions. Best choice in most situations.

Preset manual

Neutral-colored object used as reference to set white balance under unusual lighting conditions, see “Preset Manual” ( 82) for details.

Daylight

Use with subjects lit by direct sunlight.

Incandescent

Use under incandescent lighting.

Fluorescent

Use under most types of fluorescent lighting.

Cloudy

Use when shooting under overcast skies.

Flash

Use with the flash mode.

The effects of the selected option can be previewed. At settings other than **Auto**, the icon for the current setting is displayed ( 6).

Flash Mode

At white-balance settings other than **Auto** or **Flash**, turn the flash off (  28).

Preset Manual

Preset manual is used with mixed lighting or to compensate for light sources with a strong color cast (for example, to make pictures taken under a lamp with a red shade look as though they had been taken under white light).

1 Place a white or gray reference object under the lighting that will be used during shooting.

2 Use the multi selector to choose **PRE Preset manual** in the white balance menu, and press **OK**.

The camera zooms in.

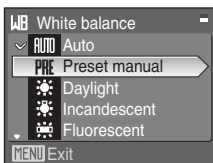

3 Choose **Measure**.

To apply the most recently measured value for preset manual, choose **Cancel** and press **OK**.

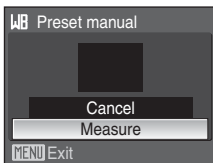

4 Frame the reference object.

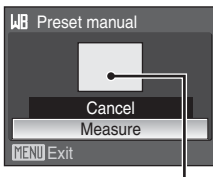

Reference object frame

5 Press **OK** to measure the white balance value.

The shutter is released and the new white-balance value is set.
No pictures are recorded.

Note on Preset Manual

Regardless of the flash mode selected, the flash will not fire when **OK** is pressed in step 5. Therefore, the camera cannot measure a value for preset manual for when the flash is used.

ISO ISO Sensitivity



Sensitivity is a measure of how quickly the camera reacts to light. The higher the sensitivity, the less light needed to make an exposure. Although a high ISO rating is suited for shooting subjects in action or in poor lighting, high sensitivity is often associated with “noise” - randomly spaced, brightly colored pixels concentrated in dark parts of the image.

Auto (default setting)

Sensitivity is ISO 80 under normal conditions; when lighting is poor and the flash is off, the camera compensates by raising sensitivity to a maximum of ISO 800 (note that ISO sensitivity is fixed at 80 in **M** mode).

80, 100, 200, 400, 800, 1600, 2000

Sensitivity will be locked at the specified value.

At the settings other than **Auto**, the current setting is displayed ( 6). If **Auto** is selected and the sensitivity is raised above ISO 80, the  icon will be displayed ( 29).

Metering

Choose how the camera meters exposure.



Matrix (default setting)

Camera sets exposure for entire frame. Recommended in most situations.



Center-weighted

Camera meters entire frame but assigns greatest weight to subject in center of frame. Classic meter for portraits; preserves background details while letting lighting conditions at center of frame determine exposure. Can be used with focus lock ( 25) to meter off-center subjects.



Spot

Camera meters area shown by circle in center of frame. Ensures that subject in metering target is correctly exposed even if background is much lighter or darker. Can be used with focus lock ( 25) to meter off-center subjects.



Spot AF area

Camera meters selected focus area ( 86). Available only when a setting other than **Center** is selected for **AF area mode**.

Note on Metering

When the digital zoom ratio is between 1.2x and 1.8x, **Metering** is set to **Center-weighted**. When the digital zoom ratio is between 2.0x and 4.0x, **Metering** is set to **Spot**. When digital zoom is in effect, the metered area is not shown.

Metering Area

The active metering area is displayed in the monitor when **Center-weighted** or **Spot** is selected.

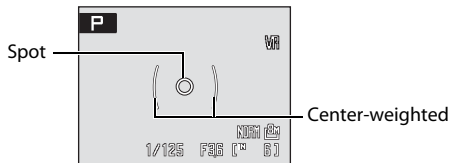

Continuous

Capture motion in a series of pictures and apply Best Shot Selector (BSS). When a setting other than **Single** is selected, the flash will be disabled, and focus, exposure and white balance are fixed at the values for the first picture in each series.

Single (default setting)

One picture is taken each time shutter-release button is pressed.

Continuous

While the shutter-release button is held down, up to 4 pictures are taken at a rate of about 2.0 frames per second (fps) when image quality is set to **NORMAL** and image size is set to **3264x2448**.

BSS

BSS is recommended for shooting under low lighting without the flash, with the camera zoomed in, or in other situations in which camera shake is likely to blur pictures.

When Best Shot Selector (BSS) is enabled, the camera shoots up to ten pictures while the shutter-release button is held down. The sharpest picture (picture with the most detail) in the series is automatically selected and saved.

Multi-shot 16

Each time shutter-release button is pressed, camera shoots 16 pictures at about 1.2 frames per second and arranges them in a single picture with image quality is set to **NORMAL** and image size is set to **3264x2448**. Digital zoom cannot be applied.

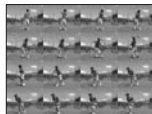

At settings other than **Single**, the indicator for the current setting is displayed ( 6).

Note on Best Shot Selector

BSS may not produce the desired results if the subject moves or the composition changes while the shutter-release button is pressed all the way down.

Notes on Continuous Shooting

- The maximum frame rate with continuous shooting may vary, depending upon the current image quality setting, image size setting, and the memory card used.
- When shooting poorly-lit subjects with **Continuous**, **BSS**, or **Multi-shot 16** selected, slower shutter speeds may not be available.

[+] AF Area Mode

Use this option to determine where the camera focuses. When digital zoom is in effect, the camera will focus on the subject in the center focus area regardless of the applied **AF area mode** option.

[Face Priority] Face priority (default setting)

The camera automatically detects and focuses on a face looking toward the camera (Shooting with Face-Priority → 87). If the camera detects multiple faces, the camera focuses on the face closest to the camera.

When shooting subjects other than people, or framing a subject with which no face is recognized, **AF area mode** will be set to **Auto**. The camera chooses the focus area (one of nine) containing the subject closest to the camera and focuses on the subject.

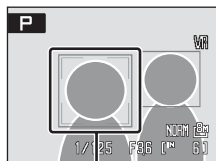

Focus area

[Auto] Auto

Camera automatically selects the focus area (one of nine) containing the subject closest to the camera. Press the shutter-release button halfway to activate the focus area. When the shutter-release button is pressed halfway, the focus area selected by the camera will be displayed.

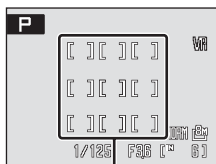

Focus area

[Manual] Manual

This option is suited to situations in which the intended subject is relatively still and not positioned in the center of the frame.

Press the multi selector ▲, ▼, ◀ or ▶ to select from 99 focus areas in the frame. Pictures can be taken while focus-area selection screen is displayed.

To end focus-area selection and adjust the flash mode, focus mode, self-timer and exposure compensation settings, press **OK**. To return to the focus-area selection screen, press **OK**.

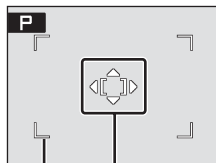

Focus area

Selectable focus areas

[] Center

Camera focuses on subject in center of frame.
Center focus area is used.

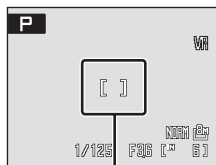

Focus area

Shooting with Face-Priority

When **Face priority** is selected for **AF area mode**, or the **Portrait** scene mode or **Night portrait** scene mode is selected during shooting, the face-priority function will be applied.

The camera automatically detects and focuses on a face looking toward the camera.

1 Frame the picture.

When the camera detects a face, the focus area containing the face will be displayed with a yellow double border.

When the camera detects more than one face, the closest face is framed by a double border and the others by single borders. Up to five faces can be detected.

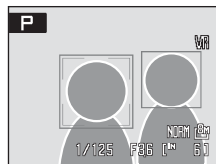
**2 Press the shutter-release button halfway.**



The camera focuses on the face framed by the double border. The double border will glow green and focus will be locked.

When the double border blinks yellow, the camera is unable to focus. Press the shutter-release button halfway again to focus.

Press the shutter-release button all the way down to take a picture.



Face-Priority

- When **Face priority** is selected for **AF area mode**, the setting will automatically switch to **Auto** if no face is recognized when the shutter-release button is pressed halfway.
- If no face is recognized when the shutter-release button is pressed halfway in **Portrait** or **Night portrait** scene mode, the camera will focus on the subject in the center focus area.
- The camera may be unable to detect faces in the following situations:
 - When faces are partially hidden by sunglasses or other obstructions
 - When faces take up too much or too little of the frame
 - When the subject is not looking directly at the camera
- The camera's ability to detect faces depends on a variety of factors, including whether or not the subject is facing the camera.
- In some rare cases shooting subjects with which autofocus may not perform as expected ( 25), the subject may not be in focus despite the fact that the focus area glows green. Should this occur, switch to  (auto) mode or change the **AF area mode** setting to **Manual** or **Center** in high-sensitivity shooting, **P**, and **M** modes, refocus on another subject positioned at the same distance from the camera as the actual portrait subject, and use focus lock ( 25).

More Information

See "Autofocus" ( 25) for more information.

Autofocus Mode

Choose how the camera focuses.



Single AF (default setting)

Camera focuses when shutter-release button is pressed halfway.



Full-time AF

Camera adjusts focus continuously until shutter-release button is pressed halfway. Use with moving subjects.

Flash Exp. Comp.

Flash compensation is used to adjust flash output, changing the brightness of the main subject relative to the background.

-0.3 - -2.0

Flash output is reduced from -0.3 to -2.0 EV, in increments of 1/3 EV, to prevent unwanted highlights or reflections.

0.0

Flash output is not adjusted.

+0.3 - +2.0

Flash output is increased from +0.3 to +2.0 EV, in increments of 1/3 EV, to make the main subject of the frame appear brighter.

At settings other than **0.0**, the icon for the current setting is displayed during shooting ( 6).

Restrictions on Camera Settings

In **P**, **M**, and **Hi ISO** (high sensitivity) modes, the following restrictions on simultaneous use of multiple functions may apply.

Flash mode

Flash mode is disabled (🔒) when a setting other than **Single** is selected for **Continuous**. Applied setting is restored when **Single** is selected for **Continuous**.

Self-timer

If self-timer is on, only one picture will be taken when shutter is released, regardless of a setting chosen for **Continuous**. The applied **Continuous** setting is restored when picture is taken or self-timer is turned off.

Optimize image

Selecting **Black-and-white** for **Optimize image** changes **White balance** to **Auto**. Selecting an option other than **Black-and-white** for **Optimize image** restores the original **White balance** setting.

Continuous















Selecting **Multi-shot 16** changes image quality setting to **NOR** **Normal** and image size setting to **3264×2448**.

AF area mode

When **AF area mode** is set to **Center** while **Metering** is set to **Spot AF area**, the **Metering** setting will automatically change to **Matrix**. When a setting other than **Center** is next selected for **AF area mode**, the **Metering** setting automatically reverts back to **Spot AF area**.

Playback Options: The Playback Menu

The playback menu contains the following options.

 D-Lighting  50
Copy current picture with enhanced details in shadows.
 Print set  73
Select pictures to print and the number of copies for each.
 Slide show  93
View pictures stored in the internal memory or on a memory card in an automatic slide show.
 Delete  94
Delete all or selected pictures.
 Protect  94
Protect selected pictures from accidental deletion.
 Small pic.  52
Create a small copy of the current picture.
 Copy  95
Copy files between memory card and internal memory.

Displaying the Playback Menu

Display the playback menu by pressing  and pressing **MENU**.



- Use the multi selector to choose and apply settings ( 11).
- To exit the playback menu, press **MENU**.

Selecting Multiple Pictures

The picture selection screen, as shown at right, will be displayed with the following menus:

- **Playback menu:** print set (73)
delete (94)
protect (94)
copy (95)
- **Setup menu:** welcome screen (98)

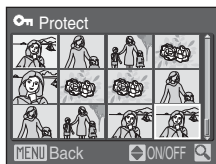

Follow the procedure described below to select multiple pictures.

- 1** Press the multi selector ◀ or ▶ to choose the desired picture.

Only one picture can be selected at a time for **Welcome screen**.

Press **T** (Q) to switch to full-frame playback.

Press **W** (E) to switch back to thumbnail display.

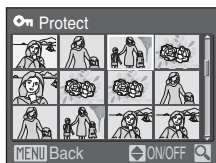

- 2** Press ▲ or ▼ to select **ON** or **OFF** (or the number of copies).

When **ON** is selected, a check mark (✓) is displayed in the top left corner of the current picture. Repeat steps 1 and 2 to select additional pictures.

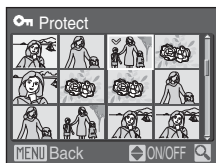

- 3** Press **OK**.

The setting is enabled.

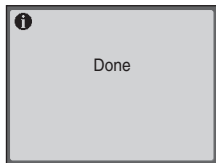

Slide Show

Play back pictures, stored in the internal memory or on a memory card, one by one in an automated “slide show.”

1 Use the multi selector to choose **Start** and press **OK**.

To change the interval between pictures, choose **Frame intvl**, select the desired interval time, and press **OK** before choosing **Start**.

To repeat the slide show automatically, enable **Loop** and press **OK** before choosing **Start**. The check mark (✓) will be added to the loop option when enabled.

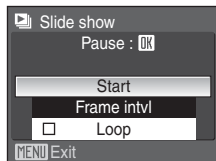

2 The slide show begins.

While the slide show is in progress, the following operations can be performed:

- Press the multi selector **▶** to view pictures in the order recorded, or **◀** to view pictures in reverse order. Press and hold **▶** to fast forward, or **◀** to rewind.
- Press **OK** to pause the slide show.



3 Choose **End** or **Restart**.

When the slide show ends or is paused, choose **End** and press **OK** to return to the playback menu, or choose **Restart** to play the slide show again.

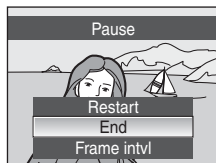

Notes on Slide Show

- Only the first frame of movies (Ⓝ 57) included in slide shows is displayed.
- Slide shows play for a maximum of 30 minutes, even when **Loop** is selected (Ⓝ 107).

Delete

Delete selected pictures or all pictures.

Erase selected images

Delete selected pictures ( 92).

Erase all images

Delete all pictures.

Notes on Deletion

- Once deleted, pictures cannot be recovered. Transfer important images to a computer before deletion.
- Pictures marked with the  icon are protected and cannot be deleted.

Protect

Protect selected pictures from accidental deletion (Selecting Multiple Pictures →  92).

Note, however, that formatting the camera's internal memory or the memory card will permanently erase protected files ( 107).

Protected pictures are recognized by the  icon ( 7, 47) in playback mode.

Copy

Copy pictures between the internal memory and a memory card.

- 1 Use the multi selector to select an option from the copy screen and press **OK**.

: Copy pictures from internal memory to memory card.

: Copy pictures from memory card to internal memory.

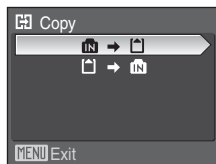



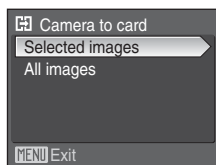

- 2 Select a copy option and press **OK**.

Selected images: Copy pictures selected from the picture selection screen ( 92).

All images: Copy all pictures.



Notes on Copying Pictures

- JPEG-, AVI-, and WAV-format images can be copied. Images recorded in any other format cannot be copied.
- If voice memos ( 53) are attached to pictures selected for copying, voice memos are copied with the pictures.
- Sound files recorded in voice recording mode ( 58) can be copied using the **Copy sound files** option ( 61) in audio playback mode.
- Pictures recorded with another make of camera or that have been modified on a computer cannot be copied.
- Edited copies have the same protection marking ( 94) as the original, but are not marked for printing ( 73).

Memory contains no images. Message

If there are no pictures stored on the memory card when playback mode is applied, the message **Memory contains no images.** will be displayed. Press **MENU** to display the copy option screen, and copy the pictures stored in the camera's internal memory to the memory card.

More Information

See "Image/Sound File and Folder Names" ( 113) for more information.

Basic Camera Setup: The Setup Menu

The setup menu contains the following options.

	Menu	 97
	Choose how menus are displayed.	
	Welcome screen	 98
	Select screen displayed when camera is turned on.	
	Date	 99
	Set camera clock and choose home and destination time zones.	
	Monitor settings	 102
	Choose information displayed in the monitor, monitor brightness, and the default display when the camera is turned on.	
	Date imprint	 103
	Imprint date or date counter on pictures.	
	Vibration reduction	 105
	Enable vibration reduction for taking still pictures.	
	AF assist	 105
	Enable or disable AF-assist illumination.	
	Digital zoom	 106
	Enable or disable digital zoom.	
	Sound settings	 106
	Adjust sound settings.	
	Auto off	 107
	Set time before camera enters standby mode.	
	Format memory/Format card	 107
	Format internal memory or memory card.	
	Language	 108
	Choose the language used for camera monitor.	
	Video mode	 108
	Adjust settings for connection to TV.	
	Reset all	 108
	Restore camera settings to default values.	
	Battery type	 111
	Choose type of batteries inserted in camera.	
	Firmware version	 111
	Display camera firmware version.	

Displaying the Setup Menu

Rotate the mode dial to **SET UP**.

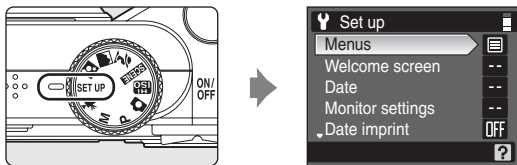

- Use the multi selector to choose and apply settings (11).
- To exit the setup menu, rotate the mode dial to another mode.

Menu

Select a format for menu display.

Text (default setting)

Text labels for menus are displayed in list format.

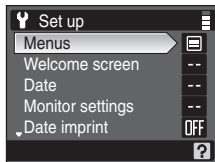

Icons

All menu items can be displayed in a single page.

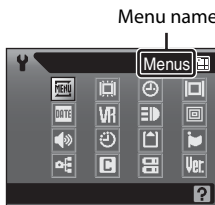

Welcome Screen

You can select the welcome screen to be displayed when the camera is turned on.



None (default setting)





Welcome screen is not displayed.

COOLPIX

Displays a welcome screen.

Select an image

Select a picture in the internal memory or on the memory card for the welcome screen. Choose a picture in the picture selection screen ( 92) and press . As the selected image is stored in the camera, the image will appear in the welcome screen even if the original picture is deleted.

Pictures taken at an **Image size** setting ( 77) of  **3264×2176** or  **3264×1836**, and copies created at a size of 320 × 240 or smaller using the crop ( 51) or small picture ( 52) function, cannot be used.

Date



Set the camera clock and choose home and travel destination time zones.

Date

Set camera clock to current date and time.

See steps 6 and 7 of the section, "Setting Display Language, Date and Time" (17), for more information.

Time zone

 (home time zone) can be specified and daylight saving enabled or disabled from **Time zone** options. When  (destination time zone) is selected, the time difference ( 101) is automatically calculated and the date and time in the selected region are recorded. Useful when travelling.

Setting Travel Destination Time Zone

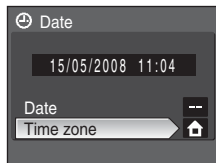

- 1 Use the multi selector to choose **Time zone** and press .

The time zone menu is displayed.



- 2 Choose  and press .

The date and time displayed changes according to the region currently selected.

If daylight saving time is in effect, use the multi selector to choose **Daylight saving** and press , and then press the multi selector . The time is automatically advanced one hour.

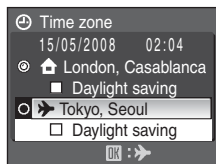

3 Press the multi selector .

The travel destination menu is displayed.

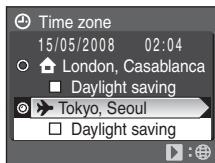

4 Choose the travel destination time zone and press .

The setting is enabled.

While the travel destination time zone is selected, the  icon will be displayed when the camera is in shooting mode.

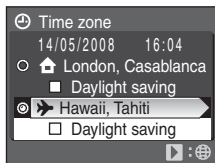



The Clock Battery

The clock battery charges when the main batteries are installed or the AC adapter (available separately from Nikon) is connected, and can provide several days of backup power after about ten hours of charging.

Home Time Zone

- To switch to the home time zone, choose  in step 2.
- To change the home time zone, choose  in step 2 and perform steps 3 and 4, to set the home time zone.

Daylight Saving Time

- If date and time are set when daylight saving time is not in effect: Turn **Daylight saving** on () when daylight saving time begins, to automatically advance the camera's clock one hour.
- If date and time are set with **Daylight saving** turned on () when daylight saving time is in effect: Turn **Daylight saving** off when daylight saving time ends, to automatically set the camera's clock back one hour.

 **Time Zones (17)**

The camera supports the time zones listed below. For time differences not listed below, set the camera clock to local time (16, 99). The table contains some locations that are not displayed on the camera's time zone map.

UTC +/-	Location	UTC +/-	Location
-11	Midway, Samoa	+1	Madrid, Paris, Berlin
-10	Hawaii, Tahiti	+2	Athens, Helsinki, Ankara
-9	Alaska, Anchorage	+3	Moscow, Nairobi, Riyadh, Kuwait, Manama
-8	PST (PDT): Los Angeles, Seattle, Vancouver	+4	Abu Dhabi, Dubai
-7	MST (MDT): Denver, Phoenix, La Paz	+5	Islamabad, Karachi
-6	CST (CDT): Chicago, Houston, Mexico City	+5.5	New Delhi
-5	EST (EDT): New York, Toronto, Lima	+6	Colombo, Dhaka
-4	Caracas, Manaus	+7	Bangkok, Jakarta
-3	Buenos Aires, São Paulo	+8	Beijing, Hong Kong, Singapore
-2	Fernando de Noronha	+9	Tokyo, Seoul
-1	Azores	+10	Sydney, Guam
±0	London, Casablanca	+11	New Caledonia
		+12	Auckland, Fiji

Monitor Settings

Choose whether or not to display information in the monitor, choose whether the monitor or the electronic viewfinder is activated when the camera is turned on, and specify monitor brightness.

Photo info

Choose information displayed in monitor in shooting mode.

Framing grid

When **On** is selected, framing guides are displayed in **A** (auto), high-sensitivity shooting, **P**, and **M** modes. The default setting is **Off**.

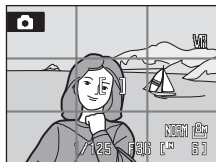

Brightness

Choose from five settings for monitor brightness. The default setting is **4**.

Default display

Choose whether the monitor (**Monitor**, default setting) or electronic viewfinder (**Viewfinder**) is activated when the camera is turned on.

Photo Info

Choose information displayed in the monitor when **[]** is pressed in shooting mode.

See “The x Button” (8) for information on indicators displayed in the monitor.

Show/hide info (default setting)

Press **[]** to switch between monitor and electronic viewfinder display, or to hide or show indicators and photo information as follows:

Monitor on (photo info displayed) → Monitor on (photo info not displayed) →
Electronic viewfinder on (photo info displayed) → Electronic viewfinder on (photo info not displayed) → Monitor on (photo info displayed)

Show info

Indicators and photo information are always shown. Press **[]** to switch between monitor and electronic viewfinder display as follows:

Monitor on (photo info displayed) → Electronic viewfinder on (photo info displayed)
→ Monitor on (photo info displayed)

Hide info

Indicators and photo information are always hidden. Press **[]** to switch between monitor and electronic viewfinder display as follows:

Monitor on (photo info not displayed) → Electronic viewfinder on (photo info not displayed) → Monitor on (photo info not displayed)

DATE Date Imprint

Date and time of recording can be imprinted on pictures. This information can be printed even from printers that do not support printing of date and time (📷 74).

Off (default setting)

Date and time are not imprinted on pictures.

Date

Date is imprinted on the bottom right corner of pictures taken while this option is in effect.

Date and time



Date and time are imprinted on the bottom right corner of pictures taken while this option is in effect.

Date counter

Time stamp shows number of days between date of recording and selected date.

At settings other than **Off**, the icon for the current setting is displayed (📷 6).

✓ Date Imprint

- Imprinted dates form a permanent part of image data and cannot be deleted.
- Dates imprinted at an image size setting (📷 77) of  (640 × 480) may be difficult to read. Choose  (1,024 × 768) or larger when using date imprint.
- The date is recorded using the format selected in the setup menu's **Date** item (📷 16, 99).
- Date cannot be imprinted on pictures taken in certain modes (📷 122).

📷 Date Imprint and Print Set

When printing from DPOF-compatible printers which support printing of shooting date and photo information, the date and information can be printed on pictures without date and time imprinted on them, using options in the **Print set** menu (📷 73).

Date Counter

Pictures taken while this option is in effect are imprinted with the number of days remaining until, or the number of days elapsed since a specified date. Use it to track the growth of a child or count down the days until a birthday or wedding.

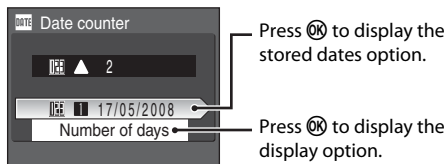

Stored dates

Up to three dates can be stored. To set, choose an option, press the multi selector **▶**, enter a date (17, step 6), and press **OK**. To select a different date, choose an option and press **OK**.

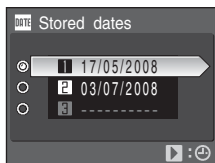

Display options

Choose **Number of days**, **Years and days**, or **Yrs, mnths, days** and press **OK**.

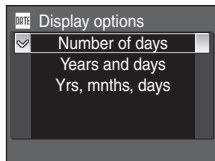

Sample date counter time stamps are shown below.



Two days remaining



Two days elapsed

Vibration Reduction

Enable or disable vibration reduction for shooting still pictures.

Vibration reduction effectively corrects blur, caused by slight hand movement known as camera shake, that commonly occurs when shooting with zoom applied or at slow shutter speeds. Vibration reduction can be used in all shooting modes.

Set **Vibration reduction** to **Off** when using a tripod to stabilize the camera during shooting.

On (default setting)

Vibration reduction is enabled when shooting still pictures.

Off



Vibration reduction is not enabled.

When vibration reduction is enabled, the current setting is displayed during shooting (when **Off** is selected, an icon for the current setting is not displayed) ( 6).

Notes on Vibration Reduction

- Vibration reduction may take a few seconds to activate after the power is turned on, or the camera enters shooting mode from playback mode. Wait until the display stabilizes before shooting.
- Due to characteristics of the vibration reduction function, images displayed in the camera's monitor immediately after shooting may appear blurry.
- Vibration reduction may be unable to completely eliminate the effects of camera shake in some situations.
- **VR** stands for vibration reduction.

Using Electronic VR with Movies

To reduce the effects of camera shake when recording movies, enable **Electronic VR** ( 56) from the movie menu ( 55).

AF Assist

Enable or disable AF-assist illumination.

Auto (default setting)

AF-assist illumination will be used to assist the focus operation when the subject is poorly lit. Note that for some scene modes, AF-assist illumination turns off automatically.

Off

Disable this function. The camera may be unable to focus if lighting is poor.

Digital Zoom

Use this setting to control digital zoom operation.

On (default setting)

Pressing and holding down **T** (Q), at the maximum optical zoom position, trigger digital zoom (22).



Crop

Limit digital zoom to the range at which image quality does not suffer.

Off

Disable digital zoom except when recording movies.

Notes on Digital Zoom

- When digital zoom is in effect, **AF area mode** is set to **Center** (86).
- Digital zoom is not available in the following situations.
 - When  (portrait) or  (night portrait) mode is selected
 - When **Multi-shot 16** is selected for **Continuous** (85)
 - Before movie recording begins (however, digital zoom of up to 2X can be applied while movies are being recorded)
- When the digital zoom ratio is between 1.2X and 1.8X, **Metering** is set to **Center-weighted**.
When the digital zoom ratio is between 2.0X and 4.0X, **Metering** is set to **Spot**.

Sound Settings

Adjust the following sound settings.

Button sound

Turn button sound on (default setting) or off.

When **On** (default setting) is selected, a beep will sound once when operations are completed successfully, twice when the camera acquires focus on the subject, and three times when an error is detected. Start-up sound will also play when the camera is turned on.

Shutter sound

Choose shutter sound from **On** (default setting) or **Off**.

Auto Off

If no operations are performed for the selected length of time, the monitor will turn off and the camera enters standby mode ( 15) to reduce drain on the batteries. The power-on lamp blinks in standby mode. If no operations are performed for another three minutes, the camera will turn off automatically. Choose the time allowed to elapse before the camera enters standby mode if no operations are performed. The available options are **30 s** (default setting), **1 m**, **5 m**, and **30 m**.

Notes on Auto Off

Regardless of the option selected, the monitor will remain on for three minutes when menus are displayed, or for up to 30 minutes when slide shows are in progress.

Format Memory/ Format Card

Use this option to format the internal memory or a memory card.

Formatting the Internal Memory

To format the internal memory, remove the memory card from the camera.

The **Format memory** option appears in the setup menu.

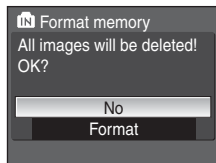

Formatting a Memory Card

When the memory card is inserted in the camera, the **Format card** option appears in the setup menu.

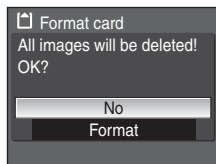

Formatting Internal Memory and Memory Cards

- Formatting the internal memory or memory cards permanently deletes all data. Be sure to transfer important pictures to a computer before formatting.
- Do not turn the camera off, disconnect the AC adapter, or open the battery-chamber/memory card slot cover during formatting.
- The first time you insert the memory cards used in other devices into the COOLPIX P60, format them with this camera.

Language

Choose one of 23 languages for display of camera menus and messages.

Čeština	Czech
Dansk	Danish
Deutsch	German
English	(default setting)
Español	Spanish
Ελληνικά	Greek
Français	French
Indonesia	Indonesian
Italiano	Italian
Magyar	Hungarian
Nederlands	Dutch
Norsk	Norwegian

Polski	Polish
Português	Portuguese
Русский	Russian
Suomi	Finnish
Svenska	Swedish
Türkçe	Turkish
中文簡體	Simplified Chinese
中文繁體	Traditional Chinese
日本語	Japanese
한글	Korean
ภาษาไทย	Thai

Video Mode

Adjust settings for connection to TV.

Choose **NTSC** or **PAL**.

Reset All

When **Reset** is selected, the camera's settings will be restored to their default values.

Pop-up Menu

Option	Default value
Flash mode (📷 28)	Auto
Self-timer (📷 30)	Off
Focus mode (📷 31)	Autofocus
Exposure compensation (📷 32)	0.0

Scene Mode

Option	Default value
Scene menu (📷 33)	Party/indoor

Movie Menu

Option	Default value
Movie options (📷 55)	TV movie 640
Autofocus mode (📷 56)	Single AF
Electronic VR (📷 56)	On

Shooting Menu

Option	Default value
Image quality (📷 76)	Normal
Image size (📷 77)	📷 3264x2448
Optimize image (📷 79)	Normal
Custom in Optimize image (📷 80)	Contrast: Auto Image sharpening: Auto Saturation: Auto
White balance (📷 81)	Auto
ISO sensitivity (📷 83)	Auto
Metering (📷 84)	Matrix
Continuous (📷 85)	Single
AF area mode (📷 86)	Face priority
Autofocus mode (📷 88)	Single AF
Flash exp. comp. (📷 89)	0.0

Setup Menu

Option	Default value
Menus (🔍 97)	Text
Welcome screen (🔍 98)	None
Photo info (🔍 102)	Show/hide info
Framing grid (🔍 102)	Off
Brightness (🔍 102)	4
Default display (🔍 102)	Monitor
Date imprint (🔍 103)	Off
Vibration reduction (🔍 105)	On
AF assist (🔍 105)	Auto
Digital zoom (🔍 106)	On
Button sound (🔍 106)	On
Shutter sound (🔍 106)	On
Auto off (🔍 107)	30 s

Others

Option	Default value
Paper size (🔍 69, 70)	Default
Frame intvl of Slide show (🔍 93)	3 s

- Choosing **Reset all** also clears the current file number (🔍 113) from the memory. Numbering will continue from the lowest number available.
- To reset file numbering to "0001", delete all pictures (🔍 94) before selecting **Reset all**.
- The following menu settings will remain unaffected when menus are reset with **Reset all**.

Shooting menu: Preset manual data (🔍 82) acquired for **White balance**

Setup menu: **Date** (🔍 99), **Date counter** (🔍 104), **Language** (🔍 108), **Video mode** (🔍 108), and **Battery type** (🔍 111)

Battery Type

To ensure that the camera shows the correct battery level ( 20), choose the type that matches the batteries currently in use.

Alkaline (default setting)	LR6 alkaline (AA-size) batteries
COOLPIX (Ni-MH)	Two EN-MH1 Rechargeable Ni-MH Batteries (available separately from Nikon) ZR6 oxyride (AA-size) batteries
Lithium	FR6 lithium (AA-size) batteries

Ver. Firmware Version

View the current camera firmware version.

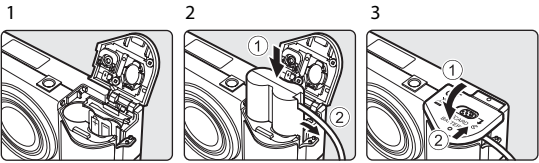

Optional Accessories

Rechargeable battery	Two EN-MH1 Rechargeable Ni-MH Batteries (EN-MH1-B2)
Battery charger	Battery Charger MH-71
AC adapter	<p>AC Adapter EH-65A (connects as shown)</p>  <p>Ensure that the power connector cord passes through the opening before closing the battery-chamber/memory card slot cover. Failure to observe this precaution could cause damage to the battery-chamber/memory card slot cover. The AC Adapter EH-62B cannot be used with the camera.</p>
USB cable	USB Cable UC-E6
A/V cable	Audio/Video Cable EG-CP14

Approved Memory Cards

The following memory cards have been tested and approved for use in the COOLPIX P60. All cards of the designated make and capacity can be used, regardless of speed.

SanDisk	128 MB, 256 MB, 512 MB, 1 GB, 2 GB ¹ , 4 GB ²
Toshiba	128 MB, 256 MB, 512 MB, 1 GB, 2 GB ¹ , 4 GB ²
Panasonic	128 MB, 256 MB, 512 MB, 1 GB, 2 GB ¹ , 4 GB ²

¹ If the memory card will be used with a card reader or similar device, check that device supports 2 GB cards.

²  SDHC-compliant. If the memory card will be used with a card reader or similar device, check that device supports SDHC.

Operation is not guaranteed with other makes of card. Contact the manufacturer for details on the above cards.

Image/Sound File and Folder Names

Pictures, movies, voice memos and voice recordings are assigned file names as follows.

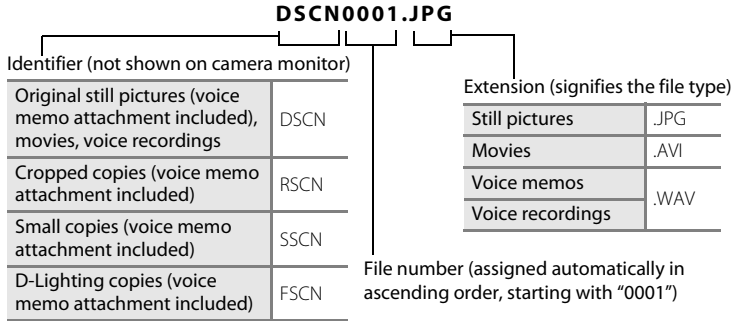

- Files are stored in folders named with a folder number followed by a five-character identifier: "P_" plus a three-digit sequence number for pictures taken using panorama assist (e.g. "101P_001"; 40), "SOUND" for voice recordings (e.g. "101SOUND"; 58), and "NIKON" for all other pictures (e.g. "100NIKON"). When the number of files within a folder reaches 9999, a new folder will be created. File numbers will be assigned automatically starting with "0001."
- Files copied using **Copy > Selected images** or **Copy sound files > Selected files** are copied to the current folder, where they are assigned new file numbers in ascending order starting from the largest file number in memory. **Copy > All images** and **Copy sound files > Copy all files** copy all folders from the source medium; file names do not change but new folder numbers are assigned in ascending order, starting from the largest folder number on the destination medium (61, 95).
- A single folder can hold up to 200 pictures; if the current folder already contains 200 pictures, a new folder, named by adding one to the current folder name, will be created the next time a picture is taken. If the current folder is numbered 999 and contains 200 pictures, or a picture is numbered 9999, no further pictures can be taken until the internal memory or memory card is formatted (107), or a new memory card is inserted.

Caring for the Camera

To ensure continued enjoyment of this Nikon product, observe the following precautions when using or storing the device:

Keep Dry

The device will be damaged if immersed in water or subjected to high humidity.

Do Not Drop

The product may malfunction if subjected to strong shock or vibration.

Handle the Lens and all Moving Parts with Care

Do not apply force to the lens, lens cover, monitor, electronic viewfinder, memory card slot or battery chamber. These parts are easily damaged. Applying force to the lens cover could result in camera malfunction or damage to the lens. Should the monitor break, care should be taken to avoid injury caused by broken glass and to prevent the liquid crystal from the display touching the skin or entering the eyes or mouth.

Do Not Point the Lens at Strong Light Sources for Extended Periods

Avoid pointing the lens at the sun or other strong light sources for extended periods when using or storing the camera. Intense light may cause deterioration of the CCD image sensor, producing a white blur effect in photographs.

Keep Away from Strong Magnetic Fields

Do not use or store this device in the vicinity of equipment that generates strong electromagnetic radiation or magnetic fields. Strong static charges or the magnetic fields produced by equipment such as radio transmitters could interfere with the monitor, damage data stored on the memory card, or affect the product's internal circuitry.

Avoid Sudden Changes in Temperature

Sudden changes in temperature, such as when entering or leaving a heated building on a cold day, can cause condensation to form inside the device. To prevent condensation, place the device in a carrying case or a plastic bag before exposing it to sudden changes in temperature.

Turn the Product Off Before Removing or Disconnecting the Power Source

Do not unplug the product or remove the batteries while the product is on, or while images are being recorded or deleted. Forcibly cutting power in these circumstances could result in loss of data or in damage to product memory or internal circuitry. To prevent an accidental interruption of power, avoid carrying the product from one place to another while an AC adapter is connected.

 **Batteries**

- Check the battery level when taking the camera out, and replace the batteries if necessary (ⓘ 20). If possible, carry spare batteries when taking pictures on important occasions.
- Battery capacity tends to decrease on cold days. Be sure that the batteries are fresh before heading outside to take pictures in cold weather. Keep spare batteries in a warm place and exchange as necessary. Once warmed, a cold battery may recover some of its charge.
- Dirt on the battery terminals can prevent the camera from functioning.
- Used batteries are a valuable resource. Please recycle used batteries in accordance with local regulations.

Cleaning

Lens/ electronic viewfinder	Avoid touching glass parts with your fingers. Remove dust or lint with a blower (typically a small device with a rubber bulb attached to one end that is pumped to produce a stream of air out the other end). To remove fingerprints or other stains that cannot be removed with a blower, wipe the lens with a soft cloth, using a spiral motion that starts at the center of the lens and working toward the edges. If this fails, clean the lens using a cloth lightly dampened with commercial lens cleaner.
Monitor	Remove dust or lint with a blower. To remove fingerprints and other stains, clean the monitor with a soft, dry cloth, being careful not to apply pressure.
Body	Use a blower to remove dust, dirt or sand, then wipe gently with a soft, dry cloth. After using the camera at the beach or seaside, wipe off any sand or salt with a dry cloth lightly dampened with fresh water, then dry thoroughly. Note that foreign matter inside the camera could cause damage not covered by the warranty.

Do not use alcohol, thinner, or other volatile chemicals.

Storage

Turn the camera off when not in use. Check that the power-on lamp is off before putting the camera away. Remove the batteries if the camera will not be used for an extended period. Do not store the camera with naphtha or camphor moth balls, or in any of the following locations:

- Next to equipment that produces strong electromagnetic fields, such as televisions or radios
- Exposed to temperatures below -10°C (14°F) or above 50°C (122°F)
- Poorly ventilated or subject to humidities of over 60 %













To prevent mold or mildew, take the camera out of storage at least once a month. Turn the camera on and release the shutter a few times before putting the camera away again.

Notes on the Monitor











- The monitor may contain a few pixels that are always lit or that do not light. This is a characteristic common to all TFT LCD displays, and does not indicate a malfunction. Images recorded using the product will not be affected.
- When framing bright subjects, vertical comet-like streaks that whiten toward either end may appear in the display. This phenomenon, known as “smear,” does not appear in the final photograph and does not indicate a malfunction. Some smear may appear in movies.
- Images in the monitor may be difficult to see under bright lighting.
- The monitor is lit by an LED backlight. Should the monitor begin to dim or flicker, contact your Nikon-authorized service representative.







Error Messages

The following table lists the error messages and other warnings displayed in the monitor, as well as the solutions for dealing with them.















Display	Problem	Solution	
 (blinks)	Clock not set.	Set clock.	99
	Batteries running low.	Prepare to change batteries.	14
 Battery exhausted.	Batteries exhausted.	Change batteries.	14
 Please wait for the camera to finish recording. 	Camera cannot perform other operations until recording is complete.	Wait until message clears from display automatically when recording is complete.	25
 Memory card is write protected.	Write-protect switch is in "lock" position.	Slide write-protect switch to "write" position.	19
 This card cannot be used.	Error accessing memory card.	<ul style="list-style-type: none"> • Use approved card. • Check that connectors are clean. • Confirm that memory card is correctly inserted. 	112
 This card cannot be read.			18
 Card is not formatted. Format card? No Yes	Memory card has not been formatted for use in camera.	Choose Yes and press  to format card, or turn camera off and replace card.	19
 Out of memory.	Memory card is full.	<ul style="list-style-type: none"> • Choose lower image quality or smaller image size. • Delete pictures or sound files. • Insert new memory card. • Remove memory card and use internal memory. 	76, 77 26, 57, 60, 94 18 19

Error Messages

Display	Problem	Solution	
 Image cannot be saved.	Error occurred while recording picture.	Format internal memory or memory card.	107
	Camera has run out of file numbers.	<ul style="list-style-type: none"> • Insert new memory card. • Format internal memory or memory card. 	18 107
	Picture cannot be used for welcome screen.	Choose picture 640 × 480 pixels or larger, or picture taken at an image size setting other than  3264×2176 or  3264×1836 .	51, 52, 77
	Cannot copy picture.	Delete pictures from destination.	94
 Sound file cannot be saved.	Camera has run out of file numbers.	<ul style="list-style-type: none"> • Insert new memory card. • Format internal memory or memory card. 	18 107
 Image cannot be modified.	Pictures cannot be modified using editing functions.	Confirm restrictions on editing using the D-Lighting, crop, and small picture functions.	49
 Cannot record movie.	Time out error while recording movie.	Choose memory card with faster write speed.	112
 Memory contains no images.	<ul style="list-style-type: none"> • No pictures or sound file in the internal memory or memory card. 	–	–
 No sound file.	<ul style="list-style-type: none"> • Memory card does not contain pictures or sound file. 	To copy picture or sound file from internal memory to memory card, press MENU . The copy option screen or copy sound file screen will be displayed.	95, 61
 File contains no image data.	File not created with COOLPIX P60.	View file on computer or other device.	–
 This file cannot be played back.			

Display	Problem	Solution	
 This image cannot be deleted.	Picture is protected.	Disable protection.	94
 Travel destination is in the current time zone.	Destination in same time zone as home.	–	101
Lens error 	Lens error.	Turn camera off and then on again. If error persists, contact retailer or Nikon-authorized service representative.	20
 Communications error	USB cable disconnected during printing.	Turn camera off and reconnect cable.	68
System error 	Error has occurred in camera's internal circuitry.	Turn camera off, remove and reinsert batteries, and turn camera on. If error persists, contact retailer or Nikon-authorized service representative.	14, 20

Error Messages



Display	Problem	Solution	
 Printer error: check printer status.	Running out of ink or printer error.	Check printer. After checking the ink or solving the problem, select Resume and press  to resume printing*.	–
 Printer error: check paper	Specified size of paper is not loaded in printer.	Load the specified paper, select Resume and press  to resume printing*.	–
 Printer error: paper jam	Paper has jammed in the printer.	Eject the jammed paper, select Resume and press  to resume printing*.	–
 Printer error: out of paper	No paper is loaded in printer.	Load the specified paper, select Resume and press  to resume printing*.	–
 Printer error: check ink	Ink error.	Check ink, select Resume and press  to resume printing*.	–
 Printer error: out of ink	Ink cartridge is empty.	Replace ink, select Resume and press  to resume printing*.	–
 Printer error: file corrupt	An error caused by the image file has occurred.	Select Cancel and press  to cancel printing.	–



* See the documentation provided with your printer for further guidance and information.

Troubleshooting

If the camera fails to function as expected, check the list of common problems below before consulting your retailer or Nikon-authorized service representative. Refer to the page numbers in the right-most column for more information.

Display, Settings and Power Supply



Problem	Cause/Solution	
Monitor is blank.	<ul style="list-style-type: none">• Camera is off.• Batteries are exhausted.• Standby mode for saving power: press the shutter-release button halfway.• Monitor and electronic viewfinder cannot be used simultaneously. Press  to alternate between displays.• Wait until flash has charged.• Camera and computer are connected via USB cable.• Camera and TV are connected via audio/video cable.	20 20 15, 24 8 29 63 62
Monitor is hard to read.	<ul style="list-style-type: none">• Ambient lighting too bright: use electronic viewfinder or move to darker location.• Adjust monitor brightness.• Monitor is dirty. Clean monitor.• Monitor has dimmed to save power. Monitor brightens when controls are used.	22 102 116 15
Camera turns off without warning.	<ul style="list-style-type: none">• Batteries are low.• Camera has turned off automatically to save power.• Batteries are cold.	20 15 115
Date and time of recording are not correct.	<ul style="list-style-type: none">• Pictures recorded before clock was set, and "Date not set" indicator blinks during shooting, will have time stamp of "00/00/0000 00:00"; movies and voice recordings will be dated "01/01/2008 00:00."• Check camera clock regularly against more accurate timepieces and reset as required.	16 99
No indicators displayed in monitor.	Shooting data and photo information may be hidden. Press  until shooting data or photo information will be displayed.	8









Problem	Cause/Solution	
Date imprint not available.	Camera clock has not been set.	16, 99
Date not appearing on pictures even when Date imprint is enabled.	Date does not appear on movies or pictures taken in  (Panorama assist) scene mode.	40, 54
Camera settings reset.	Backup battery is exhausted; all settings were restored to their default values.	100

Electronically Controlled Cameras







In extremely rare instances, unusual characters may appear in the monitor and the camera may stop functioning. In most cases, this phenomenon is caused by a strong external static charge. Turn the camera off, remove and replace the batteries, then turn the camera on again. In the event of continued malfunction, contact your retailer or Nikon-authorized service representative. Note that disconnecting the power source as described above may result in the loss of any data not recorded to internal memory or the memory card at the time the problem occurred. Data already recorded will not be affected.

Shooting

Problem	Cause/Solution	
Camera does not shoot when shutter-release button is pressed.	<ul style="list-style-type: none"> • When camera is in playback mode, press  or the shutter-release button. • When menus are displayed, press MENU. • Batteries are exhausted. • Flash is charging. 	26 12 20 29
Camera cannot focus.	<ul style="list-style-type: none"> • The intended subject is one with which autofocus does not perform well. • Set AF assist in the setup menu to Auto. • AF lamp flickers: subject not in focus area when shutter-release button pressed halfway. • Focus error. Turn camera off and then on again. 	25 105 24, 86 20



Problem	Cause/Solution	
Pictures are blurred.	<ul style="list-style-type: none"> • Use flash. • Use high-sensitivity shooting mode. • Use vibration reduction. • Use BSS. • Use tripod and self-timer. 	28 42 105 85 30
Bright specks appear in pictures taken with flash.	Flash is reflecting off particles in air. Turn flash off.	28
Flash does not fire.	<ul style="list-style-type: none"> • Flash is off. • Some scene modes that cannot turn on flash are selected. •  of focus mode is applied. •  mode is selected. • A setting other than Single is selected for Continuous. 	28 33 31 54 85
Optical zoom cannot be used.	Optical zoom cannot be used while recording movies.	54
Digital zoom cannot be used.	<ul style="list-style-type: none"> • Digital zoom in the setup menu is set to Off. • Digital zoom is not available when shooting in  (Portrait) or  (Night portrait) scene mode, before movie recording begins, or when Multi-shot 16 is selected for Continuous. 	34, 54, 85, 106
Image size not available.	Image size cannot be adjusted when Multi-shot 16 is selected for Continuous .	85
No sound when shutter is released.	<ul style="list-style-type: none"> • Off is selected for Sound settings > Shutter sound in setup menu. • A setting other than Single is selected for Continuous. •  (Sports scene mode) or  (Museum scene mode) is selected. •  mode is selected. 	106 85 38 54
AF-assist illuminator does not light.	<ul style="list-style-type: none"> • Off is selected for AF assist option in camera setup menu. • AF-assist illuminator turns off automatically in some modes. 	105 35-40

Troubleshooting

Problem	Cause/Solution	
Pictures appear smeared.	Lens is dirty. Clean lens.	116
Colors are unnatural.	White balance setting is not appropriate for light source.	81
Randomly spaced bright pixels ("noise") appear in image.	Shutter speed too slow. Noise can be reduced by: <ul style="list-style-type: none"> • Using flash • Specifying a lower ISO sensitivity setting • Choosing scene mode with noise reduction 	28 83 36
Pictures are too dark (underexposed).	<ul style="list-style-type: none"> • Flash is off. • Flash window is blocked. • Subject is beyond flash range. • Adjust exposure compensation. • Apply high-sensitivity shooting mode, or raise the ISO sensitivity. • Subject is backlit. Select  (Backlight scene mode) or use fill flash. 	28 22 28 32 42, 83 28, 39
Pictures are too bright (overexposed).	Adjust exposure compensation.	32
Unexpected results when flash set to  (auto with red-eye reduction).	When  , or "fill flash with slow sync and red-eye reduction" available in  (Night portrait) scene mode, is applied during shooting, In-Camera Red-Eye Fix may, in very rare cases, be applied to areas not affected by red-eye. Select a flash mode other than  when taking pictures in a shooting mode other than  (Night portrait) scene mode.	28, 36
The camera makes a sound when the shutter-release button is pressed halfway.	Pressing the shutter-release button halfway may activate vibration reduction. The sound of vibration reduction operation is sometimes noticeable.	105

Playback

Problem	Cause/Solution	
File cannot be played back.	File was overwritten or renamed by computer or other make of camera.	–
Cannot zoom in on picture.	Playback zoom cannot be used with movies, small pictures, or pictures that have been cropped to below 320 × 240.	–

Problem	Cause/Solution	
Cannot record or play back voice memo.	<ul style="list-style-type: none"> • Voice memos cannot be appended to movies. • Voice memos cannot be appended to pictures taken by other cameras, and voice memos recorded by other cameras cannot be played back. 	57 53
Cannot use D-Lighting, crop, or small picture options.	<ul style="list-style-type: none"> • These options cannot be used with movies. • The D-Lighting, crop, and small picture options cannot be used with pictures taken when  3264×2176 or  3264×1836 is applied in the image size setting. • Select picture that supports crop, D-Lighting, or small picture. • Pictures taken with other cameras cannot be edited. • Other cameras may be unable to play back, or transfer to a computer, pictures edited with this camera. 	57 77 49 49 49
Pictures not displayed on television.	<ul style="list-style-type: none"> • Choose correct video mode. • Memory card contains no pictures. Replace memory card. Remove memory card to play back pictures from internal memory. 	108 18
Nikon Transfer does not start when camera is connected.	<ul style="list-style-type: none"> • Camera is off. • Batteries are exhausted. • USB cable is not correctly connected. • Camera is not recognized by the computer. • Computer is not set to launch Nikon Transfer automatically. • If your computer is running Windows 2000 Professional, camera cannot be connected to the computer. <p>See the help information contained in Nikon Transfer.</p>	20 20 64 – – 65
Pictures to be printed are not displayed.	Memory card contains no pictures. Replace memory card. Remove memory card to print pictures from internal memory.	18
Cannot select paper size with camera.	Paper size cannot be selected from the camera if the printer does not support the page sizes used by the camera, or the printer automatically selects the page size. Use the printer to select page size.	69, 70

Specifications

Nikon COOLPIX P60 Digital Camera

Type	Compact digital camera
Effective pixels	8.1 million
Image sensor	$\frac{1}{2}$.35-in. CCD; total pixels: approx. 8.50 million
Lens	5 \times Zoom-Nikkor lens
Focal length	6.4-32.0mm (equivalent with 35mm [135] format picture angle: 36-180mm)
f/-number	f/3.6-4.5
Construction	9 elements in 7 groups
Digital zoom	Up to 4 \times (equivalent with 35mm [135] format picture angle: approx. 720mm)
Vibration reduction	Image-sensor shift (still pictures) Electronic (movies)
Autofocus (AF)	Contrast-detect AF, Multi area AF
Focus range (from lens)	<ul style="list-style-type: none">• (W); 40 cm (1 ft. 4 in.) to ∞ (T); 60 cm (2 ft.) to ∞• Macro close-up mode: 10 cm (4 in.) (wide-angle zoom position) to ∞
Focus-area selection	Face priority, auto (9-area automatic selection), center, manual with 99 focus areas
Electronic viewfinder	0.2-in., approx. 201k-dot equivalent, CMOS LCD viewfinder
Frame coverage (shooting mode)	Approx. 100 % vertical and 100 % horizontal
Frame coverage (playback mode)	Approx. 100 % horizontal and 100 % vertical
Monitor	2.5 in., approx. 153k-dot, TFT LCD with 5-level brightness adjustment
Frame coverage (shooting mode)	Approx. 100 % horizontal and 100 % vertical
Frame coverage (playback mode)	Approx. 100 % horizontal and 100 % vertical
Storage	
Media	<ul style="list-style-type: none">• Internal memory (approx. 12 MB)• SD (Secure Digital) memory cards
File system	DCF, Exif 2.2, and DPOF compliant
File formats	Compressed: JPEG-Baseline compliant FINE (approx. 1:4), NORMAL (approx. 1:8), BASIC (approx. 1:16) Movies: AVI Sound files: WAV

Image size (pixels)	<ul style="list-style-type: none"> • 3,264 × 2,448 [8 M] • 2,048 × 1,536 [3 M] • 1,280 × 960 [1 M] • 640 × 480 [TV] • 3,264 × 1,836 [16:9] • 2,592 × 1,944 [5 M] • 1,600 × 1,200 [2 M] • 1,024 × 768 [PC] • 3,264 × 2,176 [3:2]
ISO sensitivity (Standard output sensitivity)	ISO 80, 100, 200, 400, 800, 1600, 2000, Auto (auto gain from ISO 80 to 800)
Exposure	
Metering	96-segment matrix, center-weighted, spot, spot AF area (with support for 99 focus areas)
Exposure control	Programmed auto, manual, exposure compensation (–2.0 to +2.0 EV in steps of $\frac{1}{3}$ EV)
Range (ISO 100)	[W]: 0.7 to 16.7 EV [T]: 1.3 to 17.4 EV
Shutter	Mechanical and charge-coupled electronic shutter
Speed	$\frac{1}{1200}$ –4s, 8s (Manual mode)
Aperture	Electronically-controlled preset aperture and ND filter (–0.9 AV) selections
Range	2 steps (f/3.6 and f/8.5 [W])
Self-timer	Can be selected from 10 and 2 second duration
Built-in flash	
Range (approx.) (ISO sensitivity: Auto)	[W]: 0.4 to 5.1 m (1 ft. 4 in. to 16 ft. 8 in.) [T]: 0.6 to 4.0 m (2 ft. to 13 ft.)
Flash control	TTL auto flash with monitor preflashes
Interface	Hi-Speed USB
Data transfer protocol	MTP, PTP
Video output	Can be selected from NTSC and PAL
I/O terminal	Audio video output/digital I/O (USB)
Supported languages	Chinese (Simplified and Traditional), Czech, Danish, Dutch, English, Finnish, French, German, Greek, Hungarian, Indonesian, Italian, Japanese, Korean, Norwegian, Polish, Portuguese, Russian, Spanish, Swedish, Thai, Turkish

Specifications

Power sources	<ul style="list-style-type: none">• LR6 alkaline (AA-size) battery × 2 (supplied)• ZR6 oxyride (AA-size) battery × 2 (available separately)• FR6 lithium (AA-size) battery × 2 (available separately)• Rechargeable Ni-MH Battery EN-MH1 × 2 (available separately from Nikon)• AC Adapter EH-65A (available separately from Nikon)
Battery life*	<ul style="list-style-type: none">• Approx. 190 shots with LR6 alkaline (supplied)• Approx. 230 shots with ZR6 oxyride (available separately)• Approx. 650 shots with FR6 lithium (available separately)• Approx. 350 shots with Rechargeable Ni-MH Battery EN-MH1 (available separately from Nikon)
Dimensions (W × H × D)	Approx. 95.5 × 63.5 × 36 mm (3.8 × 2.5 × 1.4 in.) (excluding projections)
Weight	Approx. 160 g (5.6 oz) (without batteries and SD memory card)
Operating environment	
Temperature	0 to 40 °C (32 to 104 °F)
Humidity	Less than 85 % (no condensation)

* Based on Camera and Imaging Products Association (CIPA) standards for measuring the life of camera batteries. Measured at 23 °C (73 °F); zoom adjusted with each shot, flash fired with every other shot, image quality set to **NR** **Normal**, image size set to **3264 × 2448**. Battery life may vary depending on shooting interval and length of time menus and images are displayed. The supplied batteries are for trial use.

- Unless otherwise stated, all figures are for a camera with alkaline batteries operated at an ambient temperature of 25 °C (77 °F).

Specifications

Nikon will not be held liable for any errors this manual may contain. The appearance of this product and its specifications are subject to change without notice.

Supported Standards

- **DCF:** Design Rule for Camera File System is a standard widely used in the digital camera industry to ensure compatibility among different makes of camera.
- **DPOF:** Digital Print Order Format is an industry-wide standard that allows pictures to be printed from print orders stored on the memory card.
- **Exif version 2.2:** This camera supports Exif (Exchangeable Image File Format for Digital Still Cameras) version 2.2, a standard that allows information stored with photographs to be used for optimal color reproduction when images are output from Exif-compliant printers.
- **PictBridge:** A standard developed cooperatively by the digital camera and printer industries, allowing photographs to be output directly to a printer without connecting the camera to a computer.

Index

Symbols

- AE/AF-L 41
- Auto mode 20–27
- High-sensitivity shooting mode 42
- SCENE** Scene mode 34
 - Portrait 35
 - Landscape 35
 - Night portrait 36
- SETUP** Setup mode 96
 - Movie mode 54, 55
- M** (manual) mode 44
- P** (programmed auto) mode 43
 - (apply selection) button 5
 - Audio playback mode 60
 - (delete) button 26
 - Exposure compensation 32
 - Help 5, 13
- MENU** button 12
- (monitor) button 5, 8
- (playback) button 26
- Playback zoom 48, 51
- Self-timer 30
- T** (tele) 22
- W** (wide) 22
 - Thumbnail playback 47
 - Voice recording mode 58
- Vibration reduction 21, 105
- Wait icon 25, 117

A

- Accessories 112
- AE/AE-L 41
- AF area mode 86
- AF assist 105
- AF-assist illuminator 4, 25, 105
- Alkaline batteries 14, 15, 111
- Audio/video cable 62
- Auto off 107
- Autofocus 31
- Auto-focus mode 56, 88
- AVI 113
- AV-out connect 62

B

- Backlight 39
- Backlit subjects 28, 39

Batteries

- alkaline 14, 15, 111
- lithium 14, 111
- oxyride 14, 111
- rechargeable 14, 111, 112

Battery charger 112

Battery level indicator 20

Battery type 15, 111

Battery-chamber/memory card slot cover 5

Beach/snow 36

Best shot selector 38, 85

Blur 5

Brightness 102

C

Cable connector 4, 62, 64, 68

Cleaning

Body 116

Lens 116

Monitor 116

Close up 38

Close-up 31

Computer 63–66

copying pictures to 63–66

Continuous 85

Copy 95

Copy 39

Crop 51

D

Date 16–17, 99, 103

printing 74

Date counter 104

Date imprint 103

Daylight saving time 99

DCF 128

Default display 102

Delete 26, 27, 94

button 60

Design rule for camera file system 128

Digital print order format 73–74, 128

Digital zoom 106

D-Lighting 50

DPOF 128

DSCN 113

Dusk/dawn () 37

E

Electronic viewfinder 5, 22
 Electronic VR 56
 Error messages 117–120
 Exif version 2.2 128
 Exposure compensation 32
 Extension 113

F

File names 113
 Fill flash 28
 Fireworks show () 39
 Firmware version 111
 Flash 28
 Flash exp. comp. 89
 Flash mode 28, 90
 Focus 6, 31, 56, 88
 area 6, 24
 Focus area 6
 Focus mode 6
 Folder names 113
 Format 19, 107
 Framing 22
 FSCN 113
 Full-time AF 88

H

Help 13
 High-sensitivity shooting mode 42

I

Identifier 113
 Image quality 76
 Image size 77
 Infinity 31
 Internal memory 6–7, 18, 78, 107
 capacity 78
 formatting 107
 ISO sensitivity 83

J

JPEG 126
 JPG 113

L

Landscape mode () 35
 Language 16, 108

Lens 4, 116
 Lithium batteries 14, 111

M

M (manual) mode 44
 Macro close-up 31
 Manual 44
 Memory card 18, 78, 112
 approved 112
 capacity of 78
 formatting 107
 Inserting and removing 18
 slot 18

Menus 97

Metering 84

Microphone 4

Mode dial 4, 10

Monitor 5, 6–7, 20, 116
 indicators in 6–7

Monitor settings 102

Movie menu 55

Movie mode 54

Movie options 55
 maximum movie length 55
 small size 55
 TV movie 55

Movies 54, 57

 deleting 57

 playback 57

 recording 54

Multi selector 5, 11

Museum () 38

N

Night landscape () 37

Night portrait mode () 36

O

Optical zoom 22

Optimize image 79

Oxyride batteries 14, 111

P

P (programmed auto) mode 43

Panorama 40–41

Panorama assist () 40

Party/indoor () 36

Photo Info 102
 PictBridge 67–74, 128
 Playback 26, 47–52
 full-frame 26, 27
 menu 91–95
 mode 26, 27
 thumbnail 47
 zoom 48
 Playback menu 91–95
 Portrait mode (👤) 35
 Power switch 4, 14
 Power-on lamp 4, 14, 20
 Preset manual (white balance) 82
 Print set 73
 Print size 78
 Protect 94
Q
 Quick playback zoom 48
R
 Rear-curtain sync 28
 Rechargeable batteries 14, 111, 112
 Red-eye reduction 29
 Reset all 108
 RSCN 113
S
 Scene mode 34
 Self-timer 30, 90
 Self-timer lamp 4, 30
 Setup menu 96–111
 Shooting menu 75–90
 Shooting Pictures for a Panorama (🌄) 40
 Shutter-release button 4
 Single AF 56, 88
 Slide show 93
 Small picture 52
 Smear 116
 Sound settings 106
 Speaker 5
 Sports (🏃) 38
 SSCN 113
 Strap, Camera 4
 Sunset (🌇) 37
 Support information 2

I

Tele 5, 22
 Television 62
 connecting to 62
 Thumbnail playback 47
 Time zone 16–17, 99, 101
 Transfer 64
 Tripod 5

U

USB cable 63, 68

V

Vibration reduction (movies) 56
 Vibration reduction (still pictures) 105
 Video mode 108
 Viewfinder 5, 22
 Voice memo 53
 deleting 53
 playing 53
 recording 53
 Voice recordings 58
 Copying 61
 deleting 60
 making 58
 Playing 60
 Volume 57, 60

W

WAV 113
 Welcome screen 98
 White balance 81
 Wide 5, 22

Z

Zoom 22
 digital 106
 indicator 6
 optical 22
 playback 48
 Zoom buttons 5, 22, 31, 57, 60, 69
 Zoom indicator 6

Nikon

No reproduction in any form of this manual, in whole or in part (except for brief quotation in critical articles or reviews), may be made without written authorization from NIKON CORPORATION.



NIKON CORPORATION
Fuji Bldg., 2-3 Marunouchi 3-chome,
Chiyoda-ku, Tokyo 100-8331, Japan

Printed in China
YP8B01(11)
6MMA2311-01