

SureFlow[™]

Oxygen Flow Station



PROVIDER TECHNICAL MANUAL

SureFlow[™]

Table of Contents

- Definition of Product Symbols 3**

- General Information 3**
 - Warning and Caution Statements.....3

- Introduction to the SureFlow Oxygen Flow Station 4**











- Specifications 5**

- Flowmeter Replacement 6**
 - Leak Testing7

- Inlet/Outlet Valve Replacement..... 8**
 - Leak Testing8

- Cleaning..... 9**





Definition of Product Symbols

Symbol	Definition
	Warnings and Cautions
	No serviceable parts inside. Do not open cover.
	Do not expose to open flames
	No Smoking Icon: Do not smoke near unit.
	Complies with the 93/42/EEC directive drawn up by the approved organization No. 0459
	Use no oil or grease.
	Read user manual before operation. See user manual for instructions.
	This symbol is to remind the equipment owners to return it to a recycling facility at the end of its life, per Waste Electrical and Electronic Equipment (WEEE) Directive. Proper disposal of waste of electrical and electronic equipment required.
	Name and address of manufacturer
	Authorized representative in the European Community

General Information

Warning and Caution Statements

Safety instructions are defined as follows:

WARNING: 	Refer to the instructions or manual from the oxygen source manufacturer for all warnings, cautions and notes that may be applicable.
WARNING: 	Oxygen promotes rapid burning. Do not allow smoking or open flames in the same room where oxygen is being used.
WARNING: 	If a SureFlow outlet is not in use, the flowmeter must be turned to 0.
CAUTION 	The oxygen source must not exceed 20 psig (138 kPa)

Introduction to the SureFlow Oxygen Flow Station

SureFlow™ is a uniquely engineered flow station developed by AirSep® Corporation for economically administering medical-grade oxygen to multiple patients from an oxygen concentrator or other oxygen source (gas or liquid).

This product enables clinicians and medics around the world to manage and redirect the flow from a single oxygen source to a simple flow station to serve up to five individuals per SureFlow unit.

Two or more SureFlow units can be connected together to serve even more individuals simultaneously. Each flowmeter is adjusted separately to ensure precise control with a visual indication of flow for safety and comfort.

Dual flow models of NewLife® Intensity 8 and 10 LPM concentrators provide greater flexibility in delivering oxygen by allowing SureFlow to operate connected to one of the concentrator's flowmeters while the secondary flowmeter can supply oxygen for a nebulizer treatment or a higher flow patient.

SureFlow units also meet the low flow oxygen needs of pediatric patients in a critical care nursery in developing countries around the globe. The standard SureFlow is configured with 5 low flow flowmeters, which display in 0.10 increments, and can be used in a wide range of settings from 0.10 to 1.0 LPM. SureFlow can also be specially ordered with a combination of 1 LPM and 5 LPM flowmeters, or with five 2 LPM flowmeters which display in 1/8 LPM increments.

The SureFlow is a simple device that will not require a regular service schedule.

Two procedures, one for flowmeter replacement and one for inlet valve replacement, are included in the unlikely event that a repair is needed. The flowmeter or inlet/outlet valve may need replacement if it becomes damaged, or begins to leak.

SureFlow Oxygen Flow Station Specifications

Dimensions (W x H X D)	9.7 in. W x 5.8 in. H x 7.2 in. D (24.6 cm W x 14.7 cm H x 18.3 cm D)
Weight	3.28 lb (1.49 kg) 5.6 lb (2.5 kg) — Shipping Weight
Maximum Inlet Pressure	20 psig (138 kPa)
Flowmeters	Low flow flowmeters can be used from 1/10 LPM to 1 LPM with .1 LPM increments with back lines for proper viewing angle.
Flowmeter Accuracy	0-1 lpm Flowmeter ± 3% of Full Scale 0-2 lpm Flowmeter ± 5% of Full Scale 0-5 lpm Flowmeter ± 5% of Full Scale
Operating Temperature	5 - 40°C (40° - 104°F)
Storage Temperature	-5° - 60°C (30° - 140°F)

CAUTION



Disconnect from any oxygen source before attempting any service or repair.

Flowmeter Replacement

1. With a Phillips head #2 screwdriver, remove the three screws in the back of the device. Pull the bottom of the back cover out, then rotate up and away to remove the cover.

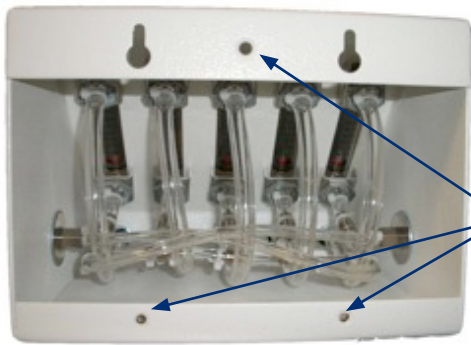

Remove 3 screws, then the rear cover

Figure 1

2. Cut the tubing to the inlet and the outlet of the flowmeter to be replaced.



Cut Tubing

Cut tubing between the barb fitting and the flowmeter inlet

Figure 2

3. Loosen and remove the pal nuts and retaining bracket that secure the flowmeter to the cabinet. Remove the flowmeter.



Remove pal nut and retaining bracket

Figure 3

4. Cut the heads off of the tie wraps that are on the two pieces of tubing that you previously cut. Remove and discard this tubing.

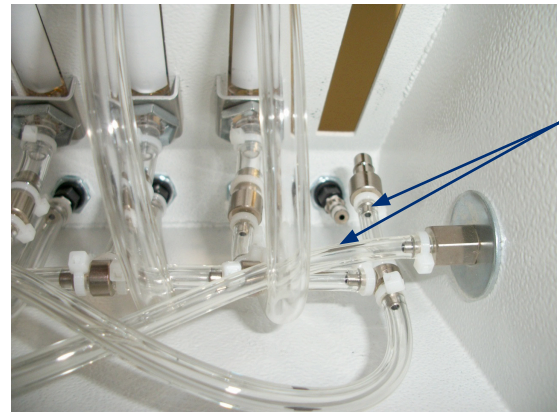

Remove tie wraps and tubing

Figure 4

5. Assemble the 8½ inch (21.6 cm) tube to the barb on the product outlet that you just removed the old tubing from and install a tie-wrap behind the barb.

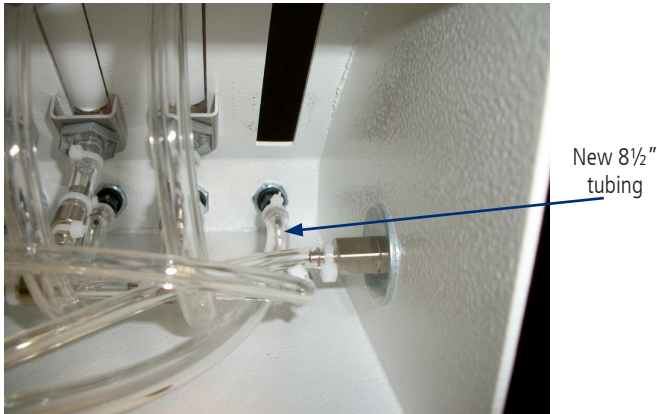

Figure 5

7. Fit the new flowmeter into the desired slot. Assemble bracket and pal nut on the flowmeter to secure the assembly to the cabinet housing.



Figure 7

6. Assemble the 1¼ inch (3.2 cm) tube to the new flowmeter inlet valve and tie wrap behind the barb.

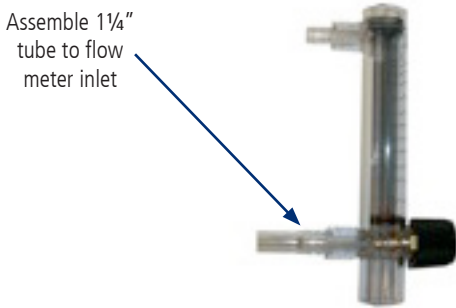

Figure 6

8. Connect the 1¼ inch (3.2 cm) tube from the flowmeter (inlet) to the barb on the tubing assembly. Next, connect the 8½ inch (21.6 cm) tube to the top of the flowmeter (outlet) and tie wrap all connection points.



Figure 8

9. Leak Testing

After any servicing is complete, the SureFlow should be checked for leaks. Attach to oxygen source and using soapy water or a leak test solution, check all tubing connections before closing.

Another aid in determining the source of a leak(s) is to put your thumb over each outlet at the SureFlow station, one at a time. The flowmeter ball must drop to zero on each test, indicating no leak within the SureFlow.

10. Replace the back cover after leak testing, and use three screws to complete the flowmeter replacement.

CAUTION



Disconnect from any oxygen source before attempting any service or repair.

Inlet/Outlet Valve Replacement

1. With a Phillips head #2 screwdriver, remove the three screws in the back of the device. Pull the bottom of the back cover out then rotate up and away to remove the cover.

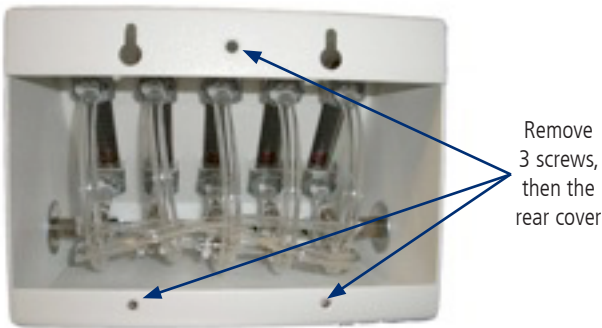

Figure 9

2. Using two wrenches, hold the inner nut in place with one wrench (7/16 inch [1.1 cm]) and unscrew the outer nut with the other wrench (5/8 inch [1.2 cm]).



Figure 10

3. Apply Teflon tape to the new inlet/outlet valve.



Figure 11

4. Using two wrenches hold the inner nut in place with one wrench (7/16 inch [1.1 cm]) and screw in the outer nut of the valve with the other wrench (5/8 inch [1.2 cm]).



Figure 12

5. Leak Testing

After any servicing is complete, the SureFlow should be checked for leaks. Attach to an oxygen source and using soapy water or a leak test solution, check all tubing connections before closing.

Another aid in determining the source of a leak(s) is to put your thumb over each outlet at the SureFlow station, one at a time. The flowmeter ball must drop to zero on each test, indicating no leak within the SureFlow.

6. Replace the back cover after leak testing and use three screws to complete the inlet/outlet valve replacement.

Cleaning

Do not use abrasive powders or chemicals. Clean only the exterior of the SureFlow unit, which can be disinfected with either a common chemical disinfectant or a diluted solution* of household bleach (sodium hypochlorite 5.25%). To use effectively, mix a solution of 1:100 parts of bleach to water. Wear eye and skin protection and allow the solution to remain on the surface for 10 minutes. After using the disinfecting solution, rinse with water and wipe dry. Make sure unit is completely dry and then retest it before you return it to inventory.

*The manufacturers of sodium hypochlorite products recommend various strengths of a bleach solution for killing bacteria, etc., based on the type of germ to disinfect; however, a generally recommended solution is $\frac{3}{4}$ cups (237 ml) of household bleach per gallon (3.79 L) of water.

CAIRE Inc. Customer Service Contact Information

If you need any additional assistance, contact CAIRE Inc:



By mail:

CAIRE, Inc.
2200 Airport Industrial Drive, Suite 500
Ball Ground, GA 30107 USA

By telephone: 800.482.2473

By E-mail: techservice.usa@chartindustries.com

www.CAIREmedical.com



Authorized European Union Representative:

Medical Product Services GmbH
Borngasse 20
35619 Braunfels, Germany

E-mail: techservice.europe@chartindustries.com

www.CAIREmedical.com

AirSep®, NewLife®, and SureFlow™ are registered trademarks of CAIRE Inc.