

# WINAUTO



(044)361-05-06

ICQ:495-089-192

(067)469-02-12

ICQ:613-211-859

(099)048-99-03

(093)672-77-76

## User's Manual

Car amplifier JBL GTO24001 1-channel

In the online store Winauto you also can [buy car amplifier JBL GTO24001](http://winauto.ua) . Delivery in Kiev and throughout Ukraine with payment upon receipt!

<http://winauto.ua>



Car Receivers - Facia Plates - Head Units - TV and Monitors - Car Antennas - Car Audio - Car DVRs - GPS Navigation - Trip Computers - Security Systems - Mechanical Locking - Car Park Systems - Cameras - Optic and Light - Car Tuning - Car Heating - Marine Audio and Electronics - Car Accessories - Car Isolation - Car Installation Components - Car Batteries - Liquid and Oil -



**JBL**

®

**GTO24001**  
**OWNER'S MANUAL**

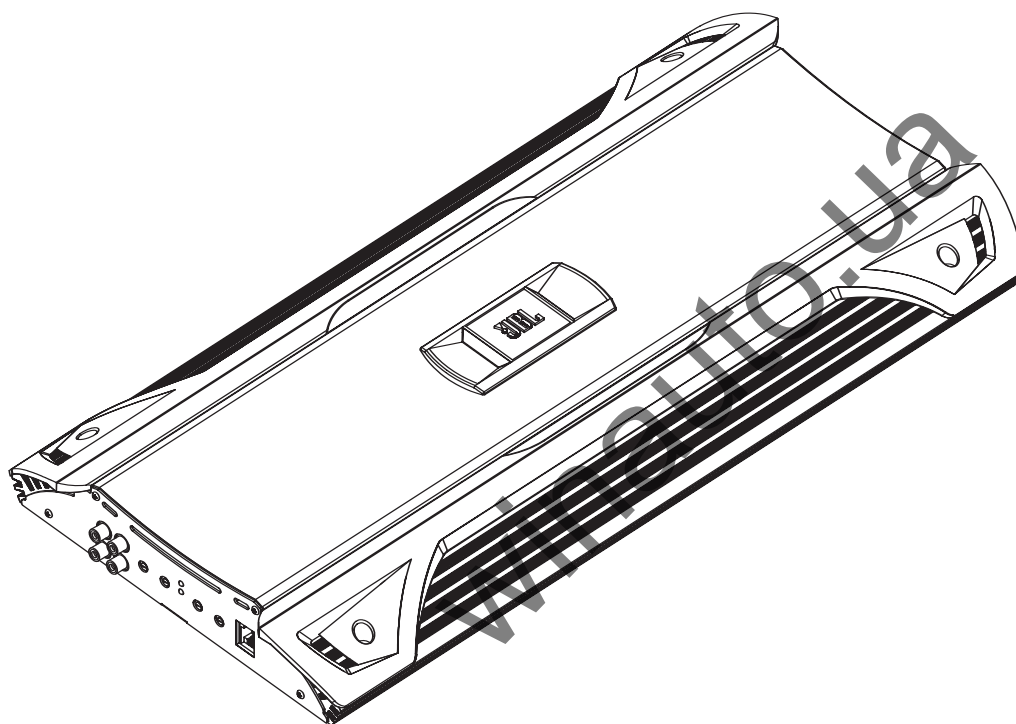

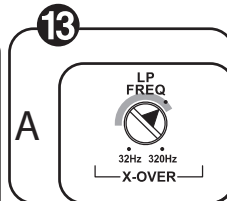
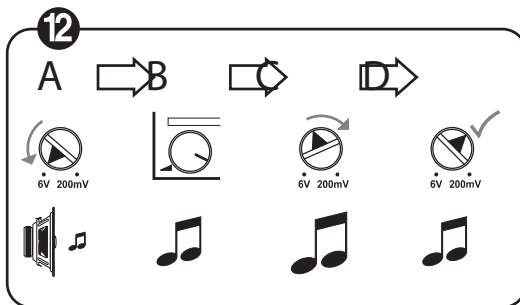
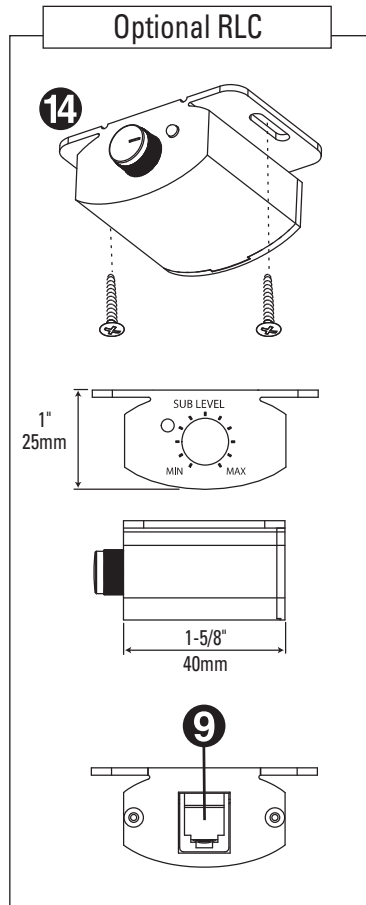
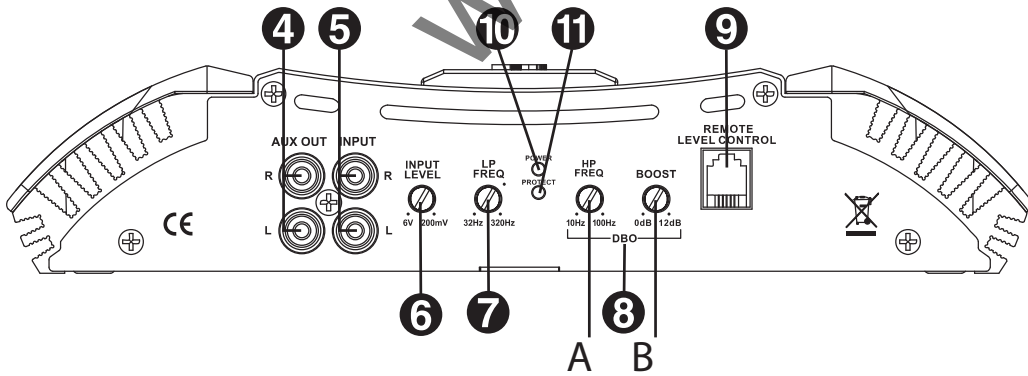
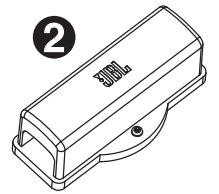
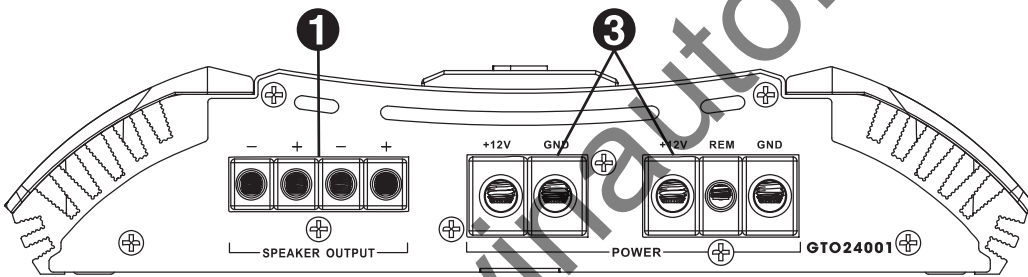
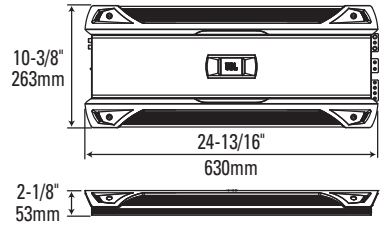
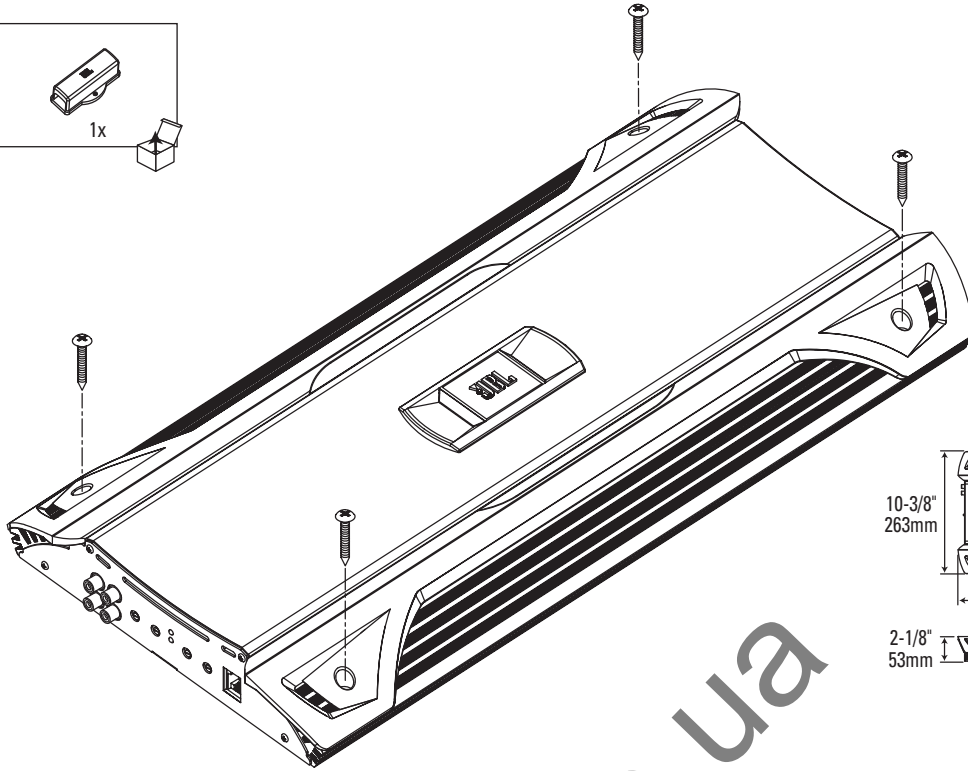
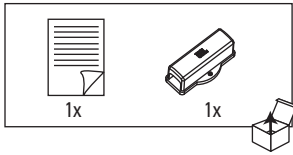

## GTO24001 CAR AUDIO SUBWOOFER AMPLIFIER OWNER'S MANUAL

### Installation Warnings and Tips

- Disconnect the negative (-) lead from your vehicle's battery.
- At the installation sites, locate and make a note of all fuel lines, hydraulic brake lines, vacuum lines and electrical wiring. Use extreme caution when cutting or drilling in and around these areas.
- Choose a safe mounting location away from moisture.
- Make sure there is sufficient air circulation at the mounting location for the amplifier to cool itself.
- Mount the amplifier, using the supplied hardware.

### Specifications

- 1700W RMS x 1 channel @ 4 ohms and  $\leq 1\%$  THD + N\*
  - 2400W RMS x 1 channel @ 2 ohms, 14.4V supply and  $\leq 1\%$  THD + N\*
  - Frequency response: 20Hz – 330Hz (-3dB)
  - Maximum input signal: 6V\*
  - Maximum sensitivity: 200mV\*
  - THD + N: 0.5%
  - Signal-to-noise ratio: 65dBA (reference 1W into 4 ohms)\*
  - Signal-to-noise ratio: 97dBA (reference rated power into 4 ohms)
- \* CEA-2006A-compliant

### 1 Speaker Output Connectors

- Connect the speakers to these terminals, observing proper polarity. Either + or - terminal may be used. Minimum total impedance is 2 ohms.

### 2 Fuse Holder/+12V Connection

- Replace fuse only with the same type and rating.
- Mount the fuse holder within 18" (45cm) of the vehicle's battery, inside the engine compartment, and connect one end of the fuse holder to the battery's "+" terminal using a single piece of 0-gauge (0 AWG, 53.5mm<sup>2</sup>) wire, as shown in Figures 1 and 2.
- For normal installation, connect two pieces of 4-gauge (4 AWG, 22mm<sup>2</sup>) wire to the other end of the fuse holder, as in Figure 1. Route both pieces of 4-gauge (4 AWG, 22mm<sup>2</sup>) wire through the car, using rubber grommets in all locations where the wire must pass through metal. Connect the other end of the 4-gauge (4 AWG, 22mm<sup>2</sup>) wire to the two "+" terminals on the amplifier's power connectors 3 (refer to illustrations page).

Figure 1.

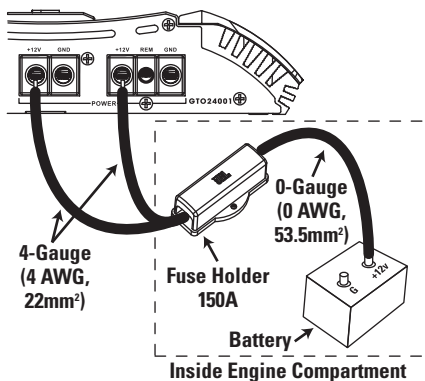

- For competition installations, replace the fuse with a 300A ANL (not included). Connect a single piece of 0-gauge (0 AWG, 53.5mm<sup>2</sup>) wire to the other end of the fuse holder, as in Figure 2. Route the 0-gauge (0 AWG, 53.5mm<sup>2</sup>) wire through the car, using rubber grommets in all locations where the wire must pass through metal. Connect the other end of the 0-gauge (0 AWG, 53.5mm<sup>2</sup>) wire to the input terminal of a power distribution block (not included) designed to accept 0-gauge (0 AWG, 53.5mm<sup>2</sup>) wire. Connect two pieces of 4-gauge (4 AWG, 22mm<sup>2</sup>) wire to the distribution block and connect the other ends of the wire to the two "+" terminals on the amplifier's power connectors 3 (refer to illustrations page).

Figure 2.

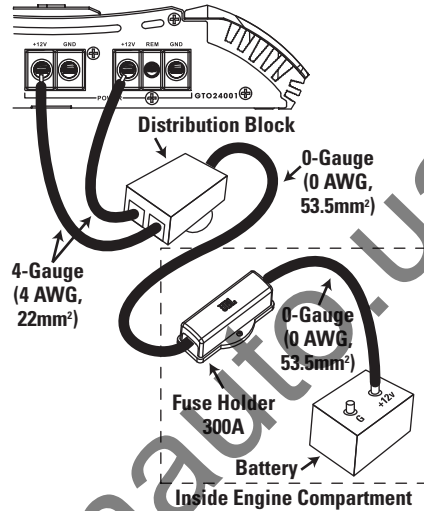

### 3 Power Input Connectors

- +12V: See "Fuse Holder" 2.
- GND: Connect to the vehicle's chassis using 4-gauge (4 AWG, 22mm<sup>2</sup>) wire. Refer to Figure 3.

Figure 3.

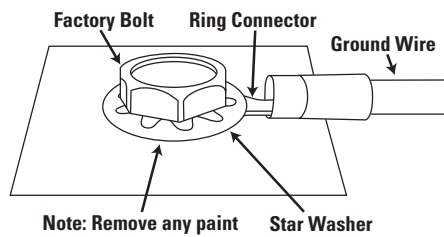

Note: Remove any paint below ring connector.

- REM: Connect to the "Remote Out" lead from the source unit or to a source of switched 12V+ (ACC).
- 4 Aux Output Connectors (RCA)
  - Nonfiltered pass-through output. Connect to the input of an additional amplifier.
- 5 Input Connectors (RCA)
  - Connect to the RCA outputs from the source unit or signal processor.
- 6 Input-Level Control
  - Used to match the input level of the amplifier to the output level of the source unit.
  - See 12 for the adjustment procedure.
- 7 Low-Pass Filter Frequency Control
  - 12dB/octave low-pass filter, variable from 32Hz to 320Hz.
  - See 13 for the adjustment procedure.

### 8 DBO (Dynamic Bass Optimization) Variable Subsonic High-Pass Filter With Variable Boost (0)

- For woofers in tuned (vented) enclosures, set the Frequency control to a value 10Hz below the enclosure's resonance (tuned) frequency.
- For woofers in sealed boxes, set the control to any value you prefer, between 30Hz and 50Hz.
- Set the Boost control according to your preference, being careful not to apply enough boost to damage your woofer(s).
  - A DBO High-Pass Filter Frequency control, variable between 10Hz and 100Hz. See above for appropriate settings.
  - B DBO Boost control provides up to 12dB of boost, slightly above the high-pass filter's frequency. See above for appropriate settings.

### 9 Optional Remote Level Control (RLC) Connector

- Connect the Remote Level Control (RLC) here, using the RJ-11 cable (supplied with the RLC).

### 10 Power On LED

- Illuminated when the amplifier is on.

### 11 Protect LED

- Illuminated under any of the following fault conditions: battery over/under voltage, short circuit in speaker wires, amplifier is too hot, amplifier's output circuit has failed (DC voltage is present in the amplifier's output).

### 12 Setting Input Level

- A Turn Input Level control counterclockwise to 6V (minimum).
- B With a dynamic music track playing, turn the head unit's volume control to the 3/4 position.
- C Turn Input Level control clockwise until the bass output is proportionate to the output of the high-frequency speakers, according to your preference.
- D Input level is now adjusted correctly.

### 13 Setting the Crossover

- A Crossover setting for subwoofers. Note: Acceptable frequency ranges are indicated in gray.

### 14 Remote Level Control (Optional)

- The Remote Level Control, if installed, will allow you to adjust the level of bass while seated in the listening position.

This product is designed for mobile applications and is not intended for connection to the mains. A valid serial number is required for warranty coverage. Features, specifications and appearance are subject to change without notice.

winauto.ua



[www.jbl.com](http://www.jbl.com)

Harman International, Consumer Division  
8500 Balboa Boulevard, Northridge, CA 91329 USA  
[www.jbl.com](http://www.jbl.com)

© 2009 Harman International Industries, Incorporated. All rights reserved.

JBL is a trademark of Harman International Industries, Incorporated,  
registered in the United States and/or other countries.

Part No. GT0240010M 7/09

**H** Harman International



Declaration of Conformity

**CE**

We, Harman Consumer Group, Inc.  
2, route de Tours  
72500 Château du Loir  
France

declare in own responsibility that the product described in this owner's  
manual is in compliance with technical standards:  
EN 55013:2001+A1:2003  
EN 55020:2002+A1:2003

  
Klaus Lebherz  
Harman Consumer Group, Inc.  
Château du Loir, France 12/08