

AdderView GEM

Installation and Use

Part	Model
AVG4	4 port AdderView GEM
AVG2	2 port AdderView GEM
RC1	Remote Control Pad / Display

www.addertec.com



Alternative language versions of this manual may be downloaded from:
www.addertec.com

Quick Installation and Operation Guide

QUICK INSTALLATION

- Power off all your computers and connect them to the ORANGE ports on the rear of the AdderView GEM. Adder 3-in-1 keyboard/video/mouse combination cables are recommended for convenience. Suitable individual standard keyboard, video and mouse cables are also widely available.
- Connect your keyboard, monitor and mouse to the GREY port on the rear of the AdderView.

OPERATION GUIDE SUMMARY

- The AdderView's default configuration is suitable for most systems.
- A computer may be selected using the front panel key, a three button mouse or a keyboard hotkey combination. To select a computer using the mouse press and release the left or right hand buttons whilst holding down the central button. To select a computer using the keyboard hotkeys hold down the CTRL and ALT keys, press and release the required port key (e.g. 1) and then release the CTRL and ALT keys.

Safety information

- For use in dry, oil free indoor environments only.
- Do not attempt to service the AdderView GEM yourself.
- Follow all warnings and instructions marked on the AdderView GEM, its optional power adapter and its accessories.
- Warning - live parts contained within optional power adapter.
- No user serviceable parts within optional power adapter - do not dismantle.
- Replace the optional power adapter with a manufacturer approved type only.
- If you use a power extension cord with the AdderView GEM, make sure the total ampere rating of the devices plugged into the extension cord does not exceed the cord's ampere rating. Also, make sure that the total ampere rating of all the devices plugged into the wall outlet does not exceed the wall outlet's ampere rating.

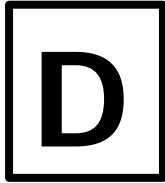

Komplette Handbuchversion Deutsche ist herunterladbar von:
www.addertec.com

Quick-Guide für Installation & Betrieb

QUICK-INSTALLATION

- Schalten Sie alle Ihre Computer aus, und schließen Sie sie an die ORANGEFARBENEN Ports auf der Rückseite des AdderView GEM an. Wir empfehlen der Einfachheit halber die Verwendung der Adder 3-in-1 Tastatur/Video/Mauskabel, es sind in der Regel jedoch auch geeignete einzelne Standardmaus-, Video- und Tastaturkabel überall im Handel erhältlich.
- Schließen Sie Ihre Tastatur, Monitor und Maus an den GRAUEN Port auf der Rückseite des AdderView an.

ZUSAMMENFASSUNG DES BETRIEBS-GUIDES

- Die Vorgabekonfiguration des AdderView ist für die meisten Systeme geeignet.
- Ein Computer kann für entweder die Verwendung der Taste auf der Frontanzeige, einer Maus mit drei Tasten oder einer Kombination der Hot-Keys der Tastatur ausgewählt werden. Zur Auswahl eines Computers, der eine Maus verwendet, die linke oder rechte Taste kurz drücken, während die mittlere Taste gedrückt gehalten wird. Um einen Computer auszuwählen, der die Hot-Keys der Tastatur verwendet, die Strg und ALT Tasten zusammen gedrückt halten, und die erforderliche Port-Taste (z.B. 1) drücken und loslassen, und dann die Strg und ALT Tasten loslassen.

Sicherheitstechnische Informationen

- Nur für den Gebrauch innerhalb von trockenen, ölfreien Räumen vorgesehen.
- Die Wartung des AdderView GEM darf nur ausschließlich von dazu qualifiziertem Fachpersonal vorgenommen werden.
- Sämtliche Warnhinweise und Anweisungen auf dem AdderView GEM, seinem optionalen Stromadapter und Zubehörteilen beachten und befolgen.
- Warnung – im Stormadapter sind unter Spannung stehende Teile enthalten.
- Keine vom Benutzer zu wartenden Teile im optionalen Stromadapter enthalten – nicht auseinandernehmen.
- Den optionalen Stromadapter nur durch einen vom Hersteller zugelassenen Typ ersetzen.
- Bei Verwendung eines Stromverlängerungskabels für den AdderView GEM, muss darauf geachtet werden, dass die Gesamtamperezahl der an dieses Kabel angeschlossenen Geräte nicht den Amperenennwert des Kabels übersteigt. Auch darauf achten, dass die Gesamtamperezahl aller an die Steckdose angeschlossenen Geräte nicht den Amperenennwert der Steckdose überschreitet.

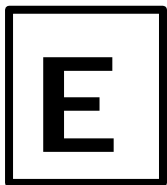

Guía rápida de instalación y funcionamiento

INSTALACIÓN RÁPIDA

- Desconecte todos los ordenadores y conéctelos a los puertos NARANJA en la parte posterior del AdderView GEM. Para mayor comodidad se recomiendan cables combinados 3-en-1 teclado/vídeo/ratón. También están ampliamente disponibles cables individuales normales adecuados para el teclado, el vídeo y el ratón.
- Conecte el teclado, el monitor y el ratón al puerto GRIS en la parte posterior del AdderView.

RESUMEN DE LA GUÍA DE FUNCIONAMIENTO

- La configuración por defecto del AdderView es adecuada para la mayoría de los sistemas.
- Puede seleccionarse un ordenador utilizando la tecla del panel frontal, un ratón de tres botones o una combinación de teclas rápidas en el teclado. Para seleccionar un ordenador utilizando el ratón, pulse y suelte los botones izquierdo o derecho mientras mantiene pulsado el botón del medio. Para seleccionar un ordenador utilizando las teclas rápidas del teclado, mantenga pulsadas las teclas CTRL y ALT, pulse y suelte la tecla del puerto requerida (p.e. 1) y a continuación suelte las teclas CTRL y ALT.

Información sobre seguridad

- Solamente debe usarse en interiores, en entornos secos y sin grasa.
- No intente realizar ningún tipo de mantenimiento al AdderView GEM usted mismo.
- Siga todos los avisos e instrucciones marcadas en el AdderView GEM, el adaptador de potencia opcional y todos sus accesorios.
- Aviso – el adaptador de potencia opcional tiene piezas con tensión.
- El adaptador de potencia opcional no contiene piezas que pueda mantener el usuario – no desmontarlo.
- Cambie el adaptador de potencia opcional solamente con un tipo aprobado por el fabricante.
- Si utiliza una cable de extensión con el AdderView GEM, compruebe que el amperaje nominal total de los equipos enchufados en el cable de extensión no superen el amperaje nominal del cable de extensión. Asimismo, compruebe que el amperaje nominal total de todos los equipos conectados a la toma de red no superen el amperaje nominal de la toma.



Téléchargez une version Français complète de ce manuel :
www.addertec.com

Guide d'installation rapide et mode d'emploi

INSTALLATION RAPIDE

- Mettez tous vos ordinateurs hors tension et raccordez-les aux ports ORANGE à l'arrière d'AdderView GEM. Les câbles clavier/vidéo/souris Adder 3-in-1 sont recommandés pour des raisons pratiques. Des câbles clavier, vidéo et souris standard se trouvent également facilement sur le marché.
- Raccordez votre clavier, moniteur et souris au port GRIS à l'arrière de l'AdderView.

MODE D'EMPLOI SOMMAIRE

- La configuration par défaut de l'AdderView convient à la plupart des systèmes.
- Pour sélectionner un ordinateur, utilisez la touche du panneau avant, une souris à trois boutons ou une combinaison de touches de raccourci clavier. Pour sélectionner un ordinateur à l'aide de la souris, maintenez la pression sur le bouton central et appuyez sur le bouton gauche ou droite avant de relâcher. Pour sélectionner un ordinateur avec les touches de raccourci clavier, maintenez les touches CTRL et ALT enfoncées, appuyez sur la touche du port souhaité (ex. 1) et relâchez, puis relâchez les touches CTRL et ALT.

Consignes de sécurité

- A n'utiliser qu'à l'intérieur, dans un environnement sec et exempt d'huile.
- Ne pas assurer soi-même l'entretien de l'AdderView GEM.
- Observer tous les avertissements et instructions marqués sur l'AdderView GEM, son adaptateur de courant optionnel et ses accessoires.
- Avertissement – l'adaptateur de courant optionnel renferme des pièces sous tension.
- L'adaptateur de courant optionnel ne contient aucune pièce devant être révisée par l'utilisateur – ne pas le démonter.
- Ne remplacer l'adaptateur de courant optionnel que par un adaptateur approuvé par le fabricant.
- Lorsqu'une rallonge est utilisée pour l'AdderView GEM, vérifier que l'intensité nominale totale des périphériques branchés sur la rallonge ne dépasse pas l'intensité nominale du câble. Par ailleurs, vérifier que l'intensité nominale totale de tous les périphériques branchés sur la prise murale ne dépasse pas l'intensité nominale de la prise murale elle-même.

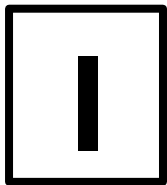

Guida di installazione rapida e funzionamento

INSTALLAZIONE RAPIDA

- Spegnere tutti i computer e collegarli alle porte ARANCIONI sul retro dell'AdderView GEM. Per facilità consigliamo i cavi Adder combinati 3-in-1 tastiera/video/mouse. Sono pure disponibili cavi mouse, video e tastiera standard individuali adatti.
- Collegare la tastiera, monitor e mouse alla porta GRIGIA sul retro dell'AdderView.

SOMMARIO GUIDA OPERATIVA

- La configurazione di default dell'AdderView è adatta alla maggior parte dei sistemi.
- Si può selezionare un computer usando il tasto sul pannello frontale, un mouse a tre bottoni o una tastiera con tasti attivi. Per selezionare un computer con il mouse, premere e rilasciare i bottoni sinistro o destro trattenendo contemporaneamente quello centrale. Per selezionare un computer con tasti attivi tastiera, tener premuti i tasti CTRL e ALT, premere e rilasciare il tasto porta richiesta (es. 1) e quindi rilasciare i tasti CTRL e ALT.

Informazioni riguardanti la sicurezza

- Da usare esclusivamente in interni asciutti e privi di olio.
- Non cercare di effettuare manutenzione sull'AdderView GEM.
- Seguire tutti gli avvertimenti ed istruzioni presenti sull'AdderView GEM, sull'adattatore opzionale di potenza e sugli accessori.
- Attenzione – l'adattatore opzionale di potenza contiene parti sotto tensione.
- L'adattatore opzionale di potenza non contiene parti soggette a manutenzione da parte dell'utente – non smontarlo.
- Sostituire l'adattatore opzionale di potenza solo con uno di tipo approvato dal produttore.
- Se si usa una prolunga con l'AdderView GEM, controllare che la potenza nominale totale in ampère dei dispositivi collegati alla prolunga non superi la potenza nominale in ampère della prolunga stessa. Controllare inoltre che la potenza nominale totale in ampère dei dispositivi collegati non superi la potenza nominale in ampère della presa a muro.

About this manual

AdderView GEM - Installation and Use

Third edition (June 2001)

(c) 2001 Adder Technology Ltd.

Part No. ADD0037/3

www.addertec.com

All rights reserved. Whilst every precaution has been taken in the preparation of this manual, Adder Technology Ltd assumes no responsibility for errors or omissions. Neither is any liability assumed for damages resulting from the use of the information contained herein. We reserve the right to change the specifications, functions and circuitry of the product without notice. All trademarks acknowledged.

Safety information

- For use in dry, oil free indoor environments only.
- Do not attempt to service the AdderView GEM yourself.
- Follow all warnings and instructions marked on the AdderView GEM, its optional power adapter and its accessories.
- Warning - live parts contained within optional power adapter.
- No user serviceable parts within optional power adapter - do not dismantle.
- Replace the optional power adapter with a manufacturer approved type only.
- If you use a power extension cord with the AdderView GEM, make sure the total ampere rating of the devices plugged into the extension cord does not exceed the cord's ampere rating. Also, make sure that the total ampere rating of all the devices plugged into the wall outlet does not exceed the wall outlet's ampere rating.

Warranty

Adder Technology Ltd warrants that this product shall be free from defects in workmanship and materials for a period of one year from the date of original purchase. If the product should fail to operate correctly in normal use during the warranty period, Adder will replace or repair it free of charge. No liability can be accepted for damage due to misuse or circumstances outside Adder's control. Also Adder will not be responsible for any loss, damage or injury arising directly or indirectly from the use of this product. Adder's total liability under the terms of this warranty shall in all circumstances be limited to the replacement value of this product.

If any difficulty is experienced in the installation or use of this product that you are unable to resolve, please contact your supplier.

Trademarks

All trademarks mentioned in this manual are acknowledged to be the property of the respective trademark owners.

Adder is a registered trademark of Adder Technology Limited.

Compaq is a registered trademark of Compaq Computer Corporation.

Hewlett-Packard is a registered trademark of Hewlett-Packard.

IBM, PC/AT, PS/2, RS/6000 and ThinkPad are registered trademarks of International Business Machines Corporation.

Logitech, MouseMan+ and Pilot Mouse+ are trademarks of Logitech Inc.

Microsoft and Windows are registered trademarks, and IntelliMouse is a trademark of Microsoft Corporation.

Velcro is a trademark of Velcro USA Inc.

Radio Frequency Energy

Shielded cables must be used with this equipment to maintain compliance with radio frequency energy emission regulations and ensure a suitably high level of immunity to electromagnetic disturbances.

European EMC directive 89/336/EEC

This equipment has been tested and found to comply with the limits for a class B computing device in accordance with the specifications in the European standard EN55022. These limits are designed to provide reasonable protection against harmful interference. This equipment generates, uses and can radiate radio frequency energy and if not installed and used in accordance with the instructions may cause harmful interference to radio or television reception. However, there is no guarantee that harmful interference will not occur in a particular installation. If this equipment does cause interference to radio or television reception, which can be determined by turning the equipment on and off, the user is encouraged to correct the interference with one or more of the following measures: (a) Reorient or relocate the receiving antenna. (b) Increase the separation between the equipment and the receiver. (c) Connect the equipment to an outlet on a circuit different from that to which the receiver is connected. (d) Consult the supplier or an experienced radio / TV technician for help.



FCC Compliance Statement (United States)

This equipment generates, uses and can radiate radio frequency energy and if not installed and used properly, that is, in strict accordance with the manufacturer's instructions, may cause interference to radio communication. It has been tested and found to comply with the limits for a class A computing device in accordance with the specifications in Subpart J of part 15 of FCC rules, which are designed to provide reasonable protection against such interference when the equipment is operated in a commercial environment. Operation of this equipment in a residential area may cause interference, in which case the user at his own expense will be required to take whatever measures may be necessary to correct the interference. Changes or modifications not expressly approved by the manufacturer could void the user's authority to operate the equipment.

Canadian Department of Communications RFI statement

This equipment does not exceed the class A limits for radio noise emissions from digital apparatus set out in the radio interference regulations of the Canadian Department of Communications.

Le présent appareil numérique n'émet pas de bruits radioélectriques dépassant les limites applicables aux appareils numériques de la classe A prescrites dans le règlement sur le brouillage radioélectriques publié par le ministère des Communications du Canada.

Contents

1. Introduction	6
1.1 Key features	6
1.2 Package contents	7
1.3 Remote controller contents	7
1.4 Product information	8
2. Installation	9
2.1 What you will need	9
2.2 Mounting the AdderView GEM	10
2.3 Connecting your devices	10
2.4 'Interface powered' operation without the optional power adapter	11
2.5 Configuring your PCs	11
2.6 Configuring the AdderView GEM	12
2.7 Summary of AdderView GEM configuration options	13
2.8 Resetting the AdderView GEM without disconnecting your devices	14
2.9 Other useful installation information	15
2.10 Re-enabling a disconnected PS/2 mouse	15
2.11 Hot plugging the AdderView GEM into running systems and re-enabling disconnected PS/2 CPU mouse connections	16
2.12 Upgrading the AdderView's flash memory	17
3. Using the AdderView GEM	20
3.1 Power on status	20
3.2 Front panel keys and remote controller	20
3.3 Status display	21
3.4 Keyboard hotkey control	22
3.5 Mouse control	23
3.6 RS232 control	24
3.7 Cascading AdderView GEMs	24
3.8 Synchronising AdderView GEMs for multiple video head applications	24

4. AdderView GEM configuration options	27
4.1 Screen saver time delay	27
4.2 Autoscan lock on mode and delay time	27
4.3 Mouse mode and mouse switching of channels	28
4.4 Keyboard hotkey combination	29
4.5 Cycling between all channels or just the active channels	30
4.6 Firmware functions (version query, mouse restore and reset)	30
4.7 Setting a security password	31
4.8 Cascade query code	32
4.9 Resolving slow mouse problems	32
4.10 Exit configure mode	33

Appendices

A - Cable and connector specifications	34
B - Problem solving	38

1. Introduction

Thank you for purchasing the AdderView GEM. Your AdderView GEM is a high performance keyboard, monitor and mouse sharing device which supports a wide range of PC hardware and software platforms.

1.1 Key features

- Control multiple PCs from a single keyboard, monitor and mouse.
- Continuous keyboard and mouse emulation on all ports ensures problem free computer bootup.
- Interface powered operation – AdderView GEM draws its power from the connected computers for maximum convenience.
- Intelligent switching feature enables users to switch between all ports or just the active ports.
- Supports high bandwidth monitors at resolutions up to 1900 x 1440 with an excellent video transfer characteristic - high bandwidth and low distortion.
- Mixed AT/PS2 keyboards and PS2/RS232 mice supported as standard.
- Flash upgradeable - AdderView GEM's firmware may be upgraded by connecting a computer's serial port and running a download program.
- Can be cascaded to provide a video switching network.
- Video channels support Display Data Channel (DDC/DDC1/DDC2) signalling.
- Password security prevents unauthorised use.
- User options stored in EEPROM memory.
- Remote control module for convenient operation.
- Channel switching by front panel key, keyboard hotkey, or 3 button mouse.
- Automatically restores keyboard and mouse states when channel changed.
- Supports keyboard modes 1,2 and 3 and mouse prompt and stream modes for maximum compatibility.

- Can be controlled remotely via an RS232 serial port.
- Includes screen saver, auto-scan and variable hotkey options.
- Supports Microsoft IntelliMouse, IntelliMouse Explorer and other common wheel mice.
- Mouse restoration functions to enable 'hot plugging' of certain systems.
- Keyboard, mouse and AdderView GEM resets may be performed without disconnecting devices.
- Supports IBM ThinkPad 'Y' cables.
- Power and activity indication confirm correct operation.
- Standard cable connections make installation easy and inexpensive.
- All ports are active simultaneously – all PCs may all be booted at the same time.
- Robust metal case ensures good shielding and video quality.
- Supports desktop and laptop PCs, RS6000s, DEC Alphas, and Silicon Graphics computers .
- Supports very wide range of software including Windows 3.X, WFWG, 95, 98, 2000, NT, DOS, Unix, Linux, NetWare, OS/2, BSD etc.
- Optional power adapter can be used for 'video only' or cascade applications.

1.2 Package contents

- AdderView GEM.
- This installation guide.
- (Please note that a power adapter is NOT required for most applications and so is not included. This may be purchased separately if required - part code AVGPSU).

1.3 Remote controller contents (part code: RC1)

- Remote control module.
- Velcro strip for mounting remote controller.

1.4 Product information

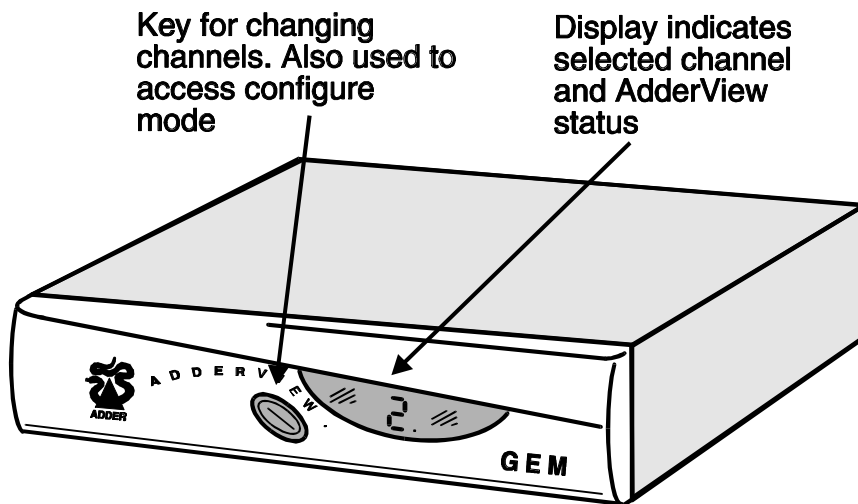

Figure 1 - AdderView GEM front view

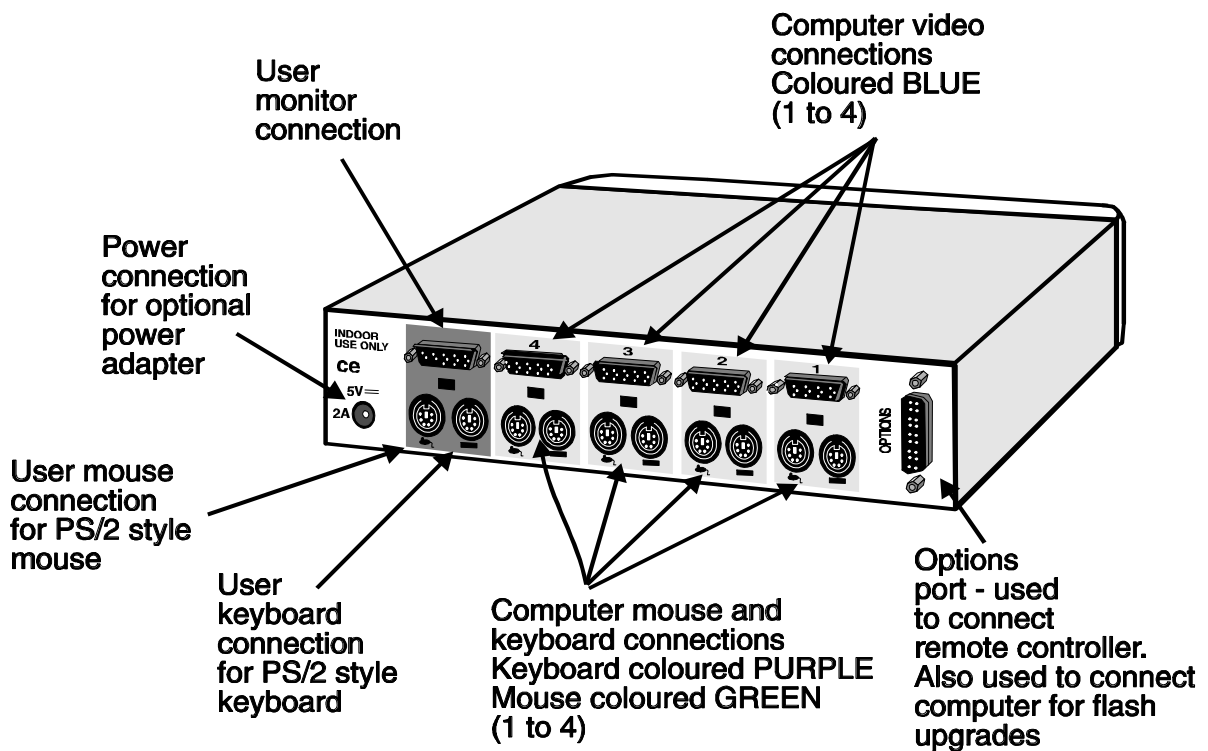

Figure 2 - AdderView GEM rear view (4 port model)

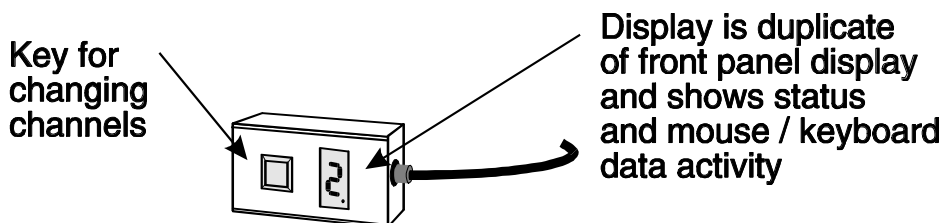

Figure 3 - Remote control pad / display (optional accessory - part RC1)

2. Installation

2.1 What you will need

- Cables to connect the AdderView GEM to each of your PC keyboard, video and mouse ports. Cable specifications are given in appendix A. (You do not need to connect a mouse cable if you are not using the mouse).
- A monitor with a standard VGA/SVGA (15 pin) connector that will work when connected directly to each of your PCs. AdderView GEM supports low and high resolution monitors.
- A standard AT or PS/2 style keyboard. If you are using an AT keyboard with a 5 pin connector you may connect this to the AdderView GEM using a standard AT to PS/2 keyboard adapter.
- A PS/2 style two or three button Microsoft or Logitech compatible mouse or a Microsoft IntelliMouse / IntelliMouse Explorer compatible mouse. If you wish to use the mouse to switch the AdderView GEM's channel then you will need a three button mouse or an IntelliMouse.

(The AdderView GEM supports 'Internet Mice' that are compatible with the Microsoft IntelliMouse. These are fitted with a wheel or other scroll control and sometimes have additional buttons. Examples are: Microsoft IntelliMouse, Logitech Pilot Mouse+, Logitech MouseMan+, Genius NetMouse and Genius NetMouse Pro.)

- A suitable mouse driver for your PCs. Supported types are:
 - PS/2 or RS232 two button mouse driver (any manufacturer).
 - Microsoft mouse driver (including IntelliMouse).
 - Logitech mouse driver (including two button, three button and wheel mouse)

Use of PS/2 and RS232 style mice with the AdderView GEM - All of the mouse connections from AdderView GEM to PCs support either a PS/2 or an RS232 mouse. AdderView GEM automatically converts from the PS/2 mouse commands to RS232 serial mouse commands. Serial mice types are selected by using an adapter as described in Appendix A. The AdderView GEM will operate without a mouse connected if you do not wish to use one.

2.2 Mounting the AdderView GEM

The AdderView GEM has been designed for use on a desktop or shelf in close proximity to the user's monitor and peripherals. The optional remote controller may be used if you wish to locate the AdderView GEM on a desk or shelf that is some distance from the monitor and peripherals.

2.3 Connecting your devices

Ensure that the optional power adapter is disconnected from the AdderView GEM and that all the devices which are to be attached are switched off. Connect the shared keyboard, PS/2 mouse and monitor to the connectors at the rear of the AdderView GEM (see figs 1, 2 and 3). Next, connect each computer system unit in turn with the keyboard cable, mouse cable and video cable. Adder 3-in-1 keyboard/video/mouse cables are recommended for maximum convenience. Any unused computer connections can be left unconnected. To connect computers with serial mouse connections and AT style keyboard connections use the adapters specified in appendix A. If you have an existing 6-pin mini-DIN to 9-pin serial adapter that came with a mouse it may not be suitable for use with the AdderView as there are several different standard wiring configurations for these adapters.

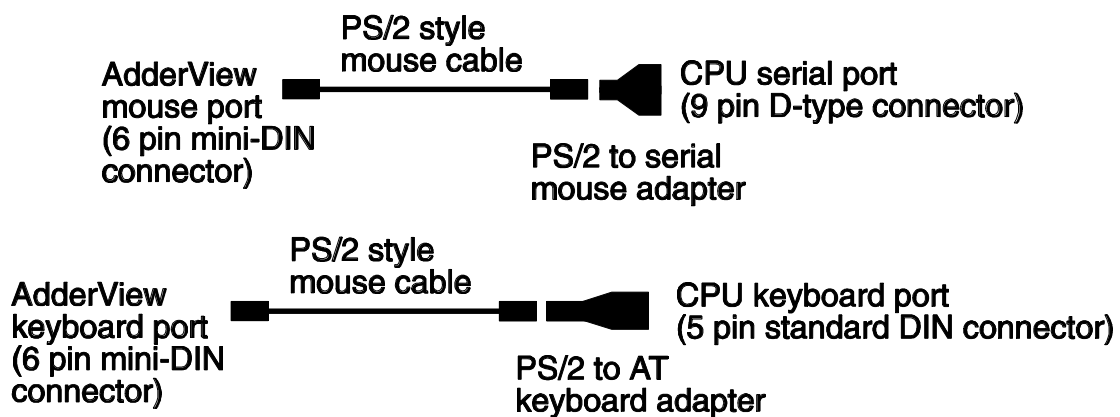

The AdderView GEM is now ready for use and will start to operate as soon as one of the attached PCs is powered on. If you are connecting to PCs using cables that are longer than 5 metres or are cascading the AdderView GEM to another AdderView GEM you will need to use the optional power adapter. When using the optional power adapter, ensure that it is connected to the mains and powering the AdderView GEM before you switch on the connected computers. Failure to switch the AdderView GEM and computers on in the correct order can lead to the mouse and/or keyboard not being recognised by the computers when they are switched on.

2.4 'Interface powered' operation without the optional power adapter

The AdderView GEM draws its power from the connected computers via the keyboard cables. A single keyboard connection is normally sufficient to power the AdderView GEM provided that the cable is no longer than 5 metres. If more than one computer is connected then the power will be intelligently drawn from all computers. Cables longer than 5 metres may be used provided that the AdderView GEM is already powered by another connected computer or the optional power adapter. If you are cascading the AdderView GEM to another AdderView GEM then a power adapter must be connected to all AdderView GEMs.

2.5 Configuring your PCs

Configure your PC in the same way that you would if your keyboard, mouse and monitor were all connected directly to your PC. AdderView GEM emulates Microsoft compatible serial, IntelliMouse, IntelliMouse Explorer and PS/2 mice, so ensure that your PC software is configured for a Microsoft mouse of the correct type. Refer to the list of supported drivers in section 2.1.

2.6 Configuring the AdderView GEM

The AdderView GEM is supplied pre-configured with factory defaults which are suitable for most applications. There are a number of more advanced options which can be set by the user. These are stored in the AdderView GEM's EEPROM memory and are retained when the power is disconnected.

The options may be changed whilst the AdderView GEM is in configure mode. You may enter configure mode at initial power on or whilst the AdderView GEM is running:

To enter configure mode at power on:



Switch off all the attached PCs and the AdderView GEM. Hold down the front panel key whilst powering on the AdderView GEM. Remember that the AdderView GEM draws its power from any attached PC via the keyboard cable and so will power itself on when the attached PC is switched on or when the optional power adapter is connected. Do not release the key until the AdderView GEM displays 'C' to show that it has entered configure mode.

To enter configure mode whilst the AdderView GEM is running:

Hold down the front panel key for 5 seconds until the front panel display shows 'C'.

In configure mode, options are entered by typing a letter followed by a number followed by (return). Use ESC to abort the entry of an option. The AdderView GEM will remain in configure mode until you type 'E' (return).

For example: to set hotkey option 2 type the following at the 'C' prompt

(at AdderView GEM 'C' prompt)   

To exit configure mode type:  

2.7 Summary of AdderView GEM configuration options

Full details of each of the configuration options and their uses are given in section 4.

- B1** - screen saver disabled (default)
- B2** - Blank screen after 1 minute of inactivity
- B3** - Blank screen after 2 minutes of inactivity
- B4** - Blank screen after 4 minutes of inactivity
- B5** - Blank screen after 8 minutes of inactivity
- B6** - Blank screen after 12 minutes of inactivity
- B7** - Blank screen after 16 minutes of inactivity
- B8** - Blank screen after 20 minutes of inactivity

- L1** - AdderView GEM locks on to active ports only during autoscanning (default)
- L2** - AdderView GEM locks on to every port during autoscanning
- L3** - AdderView GEM powers on in autoscan mode and locks on to active ports only
- L4** - AdderView GEM powers on in autoscan mode and locks on to all ports

- L5** – Allow the mouse to run at any speed (default)
- L6** – Don't allow the mouse to run at very slow speeds

- L7** - Cascade query code = AD (default)
- L8** - Cascade query code = EF

- T1** - 2 seconds autoscan delay time before switching to next port (default)
- T2** - 5 seconds autoscan delay time before switching to next port
- T3** - 7 seconds autoscan delay time before switching to next port
- T4** - 10 seconds autoscan delay time before switching to next port
- T5** - 15 seconds autoscan delay time before switching to next port
- T6** - 20 seconds autoscan delay time before switching to next port
- T7** - 30 seconds autoscan delay time before switching to next port
- T8** - 60 seconds autoscan delay time before switching to next port

- U1** - AdderView GEM channels are switchable using a 3 button mouse or IntelliMouse (default)
(AdderView GEM reports 2 button mouse mode to PCs)
- U2** - AdderView GEM channels are not switchable using 3 button mouse or IntelliMouse
(AdderView GEM reports 2 button mouse mode to PCs)
- U3** - AdderView GEM channels are not switchable using 3 button mouse or IntelliMouse
(AdderView GEM reports 3 button mouse mode to PCs)
- U4** - AdderView GEM channels are switchable using 3 button mouse or IntelliMouse
(AdderView GEM reports IntelliMouse mode to PCs)
- U5** - AdderView GEM channels are not switchable using 3 button mouse or IntelliMouse
(AdderView GEM reports IntelliMouse mode to PCs)

- U7** – Cycle between all ports when switching with 'Hotkeys + Tab' or three button mouse (default)
- U8** – Cycle between active ports only when switching with 'Hotkeys + Tab' or three button mouse

- H1** - Hotkey combination is CTRL + ALT + command key (default)
- H2** - Hotkey combination is CTRL + SHIFT + command key
- H3** - Hotkey combination is ALT + SHIFT + command key
- H4** - Hotkey combination is RIGHT ALT + command key
- H5** - Hotkey combination is LEFT ALT + RIGHT ALT + command key
- H6** - Hotkey combination is LEFT CTRL + LEFT ALT + command key
- H7** - Hotkey combination is RIGHT CTRL + RIGHT ALT + command key
- H8** - No hotkey combination enabled

- F1** - Display firmware first digit (Note: F1 is **F** followed by **1** NOT **F1**)
- F2** - Display firmware second digit
- F3** - Display firmware third digit
- F5** - Restore PS/2 mouse function
- F6** - Restore IntelliMouse function
- F8** - RESET all configurations to default settings. (Display confirms with 'r').

P - Sets password - see section 4.6 for instructions.

E - Exits configure mode and returns the AdderView GEM to normal operation mode.

2.8 Resetting the AdderView GEM without disconnecting your devices

The AdderView GEM draws its power from the connected computers and therefore may only be fully powered down when all the connected computers have been switched off or disconnected. However, the AdderView GEM may be reset without disconnecting or powering down your computers by using the reset switch on the underside of the unit. Performing a reset using this switch performs a complete hardware reset on the AdderView GEM and is equivalent to switching off the power. To perform a hardware reset, move option switch 8 to the ON position (halt and reset) and then back to the OFF position (normal operation).

2.9 Other useful installation information

PC boot up sequence - When your PCs are powered on they communicate with any attached keyboards and mice and setup parameters required by the particular operating system. It is necessary for the AdderView GEM to be attached and powered on during this sequence so that it can give the required responses and keep track of all the modes and settings requested by each of the connected PCs.

Mouse characteristics - do not unplug a PS/2 mouse connection from a PC whilst the PC is on. Due to the design of PS/2 mice communications the mouse function on the PC will be lost and you will have to re-boot the PC to regain normal operation. Unplugging the mouse from the AdderView GEM will also cause it to stop operating when it is plugged back in. RS232 mice can usually be unplugged and plugged back in provided that a mouse was connected when the operating system initially booted. The AdderView GEM is fitted with a PS/2 mouse recovery system which allows you to disconnect and re-connect the shared mouse without powering down the system (although this is generally not advisable) - see section 2.10 for details.

Keyboard and mouse mode switching - The AdderView GEM keeps a log of the keyboard and mouse mode and resolution settings requested by each of the connected PCs. These settings are automatically restored to the shared keyboard and mouse when the AdderView GEM channel is switched thus ensuring maximum software compatibility. The keyboard num, caps and scroll lock states are an obvious example of this process.

2.10 Re-enabling a disconnected PS/2 mouse

If you disconnect the shared PS/2 mouse from the AdderView GEM by accident during operation then the mouse operation will be lost when the mouse is plugged back in. To avoid having to reboot the entire system in this situation the AdderView GEM is fitted with an automatic mouse recovery system.

With the PS/2 mouse disconnected, change the channel using the keypad or keyboard hotkeys. The AdderView GEM detects that the mouse has been disconnected and triggers the automatic recovery system. Plug in the PS/2 mouse and the AdderView GEM will re-initialise it.

Alternatively you can reset the keyboards and mice by holding down the front panel key for 5 seconds. When the character 'C' is displayed on the front of the AdderView GEM, press the front panel key again. A complete power off reset of the connected keyboards and mice will then be performed. This function only resets the shared keyboard and mice that are plugged into the control port. It does not affect the status of any of the other ports on the switch or the CPU connections.

2.11 Hot plugging the AdderView GEM into running systems and re-enabling disconnected CPU PS/2 mouse connections

It is advisable to switch off the systems that are going to be connected to the AdderView GEM before installation. However, if this is not possible then most systems can be hot plugged by using the AdderView GEM's mouse restoration functions. The keyboard connection will normally restore itself automatically.

On many PCs, mouse movement will be lost if the PS/2 mouse is unplugged and plugged back in whilst the PC is running. Mouse movement can then only be restored by rebooting the PC. This is because the mouse drivers only setup and enable the mouse when the PC is initially booted.

If you have switched off your AdderView GEM or you are attempting to 'hot plug' it into a system that is already running, you may be able to restore lost mouse movement using the AdderView GEM's mouse restoration functions.

Mouse restoration functions should be used with care as unpredictable results may occur if the wrong mouse type is selected. If in doubt restore the mouse by powering down the PC normally.

Standard PS/2 mouse data uses a different data format to IntelliMouse data and so two reset functions are provided on the AdderView GEM. The type of data format expected by the PC depends upon the driver and the type of mouse that was connected when the driver was booted. The following table may be used as a guide. Note that the mouse reset functions predict the likely mouse resolution settings but may not restore the speed or sensitivity of the mouse exactly as they were when the PC originally booted.

Type of mouse / system Connected at bootup	Driver type	Likely expected data format	Suggested restoration
PS/2	PS/2 only	PS/2	F5
PS/2	IntelliMouse	PS/2	F5
IntelliMouse / AdderView GEM	PS/2 only	PS/2	F5
IntelliMouse / AdderView GEM	IntelliMouse	IntelliMouse	F6

To restore lost mouse movement on a CPU connected to the AdderView GEM:

- 1) Select the CPU that has lost its mouse movement
- 2) Press the select key on the front of the AdderView GEM for 5 seconds until 'C' is displayed. You are now in configure mode.
- 3) To restore a PS/2 mouse connection press



Or, to restore an IntelliMouse connection press



- 4) Exit from configure mode by typing



- 5) Test the mouse movement by moving the mouse a short distance.

F5 - Restore PS/2 mouse function

F6 - Restore IntelliMouse function

2.12 Upgrading the AdderView's flash memory

The AdderView GEM uses flash memory technology which enables the firmware code to be upgraded by the user. Upgrades are performed by connecting a PC's serial port to the AdderView's options port and running an upgrade program on the PC. This upgrade program downloads the new firmware to the AdderView and checks that the data has been programmed correctly.

To perform a firmware upgrade on your AdderView GEM you will need a suitable serial upgrade cable and an IBM PC compatible computer with an RS232 serial port and an operating system that supports DOS. Upgrade cables may be purchased for Adder Technology or may be made using the wiring specification given in Appendix A4. You will also need to download the latest version of the AdderView GEM firmware which is available free of charge at www.addertec.com.

To perform a flash upgrade on the AdderView GEM:

Step 1 - Connect your computer to the AdderView

Connect your computer's serial port to the AdderView GEM's options port (labelled OPTIONS/FLASH).

Step 2 - Select flash upgrade mode using option switch 7

Move option switch 7 on the underside of the AdderView GEM to the ON position.

Step 3 - Reset the AdderView GEM

Reset the AdderView GEM by moving option switch 8 to the ON position (halt and reset) and then back to the OFF position (normal operation). Alternatively you may reset the AdderView by powering off all the attached computers and removing the optional power adapter.

Step 4 - Ensure that the AdderView is powered on

Ensure that the AdderView is powered on. It is normally possible to upgrade the AdderView when it is powered from a single computer, however it is good practice to ensure that there is the maximum possible power availability during flash upgrades and so if possible ensure that all the computers are powered on. The upgrade program monitors the AdderView's voltage and will not allow an upgrade to be performed if the voltage is insufficient.

The display should now show:

DISPLAY SHOWS

Lower case u

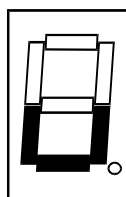

MEANING

AdderView GEM is ready to be upgraded

Step 5 - Run the upgrade program

The latest version of the AdderView GEM firmware is available from the Adder Technology website at www.addertec.com. The program and data files are supplied as a pair e.g.

AVG129.EXE

AVG129.HEX

and should be downloaded to the same directory on your PC. Run the file AVGxxx.EXE (e.g. AVG129.EXE) and follow the on-screen instructions. During the upgrade the display will show an upper case U and the dot will flash to show that the upgrade is in progress.

DISPLAY SHOWS

Upper case U

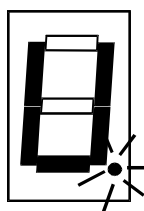

MEANING

AdderView GEM is in flash upgrade mode

Flashing dot indicates that data is being received from the PC

The display will again show a lower case U when the download is complete. Move option switch 7 to the OFF position to exit upgrade mode and start normal operation. You may check the new firmware version by entering configure mode and using the firmware version query function.

Some useful issues to bear in mind when performing flash upgrades

The upgrade program rewrites the AdderView's firmware code. If the upgrade process is interrupted then the AdderView will have invalid code and will not be able to operate. It is therefore good practice to ensure that the upgrade process is always fully completed. A partial or failed upgrade may be rectified by performing another upgrade. If the upgrade process is interrupted accidentally then you should immediately repeat the upgrade process without moving switch 7 from the flash upgrade (ON) position. Switch 7 forces the AdderView into flash upgrade mode and prevents the upgraded code from being run. Running faulty or partially upgraded code may have unpredictable results and may damage your AdderView or computing equipment. For obvious reasons, the code that the AdderView uses to perform upgrades is not itself upgradeable - a common problem on some flash upgradeable products that could effectively be destroyed by a partial upgrade!

WARNING - Running faulty or partially upgraded code may have unpredictable results and may damage your AdderView or computing equipment.

3. Using the AdderView GEM

This section explains the general operation of the AdderView GEM. We recommend that you read this section before starting to use the product.

3.1 Power on status

At power on the AdderView GEM selects computer 1 and displays '1'. If a password has been set then 'P' will be displayed and the AdderView GEM will remain locked until a valid password is entered.

DISPLAY SHOWS

Display doesn't show '1' or 'P'

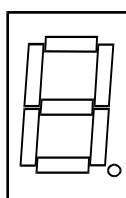

MEANING

No power is available or insufficient power is available from the connected PCs

Channel '1' or 'P' prompt

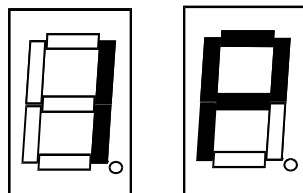

AdderView has powered up normally and there is sufficient power available from the connected PCs

3.2 Front panel key and remote controller

The front panel key is used to select which channel is currently controlled by the shared keyboard, mouse and monitor ports. Pressing the key during normal operation will cause the next channel to be selected.

The key can also be used to access the AdderView GEM's configuration mode (see section 2.6). To do this press the key and hold it down for 5 seconds until 'C' appears on the AdderView GEM's front panel display.

An optional remote controller is also available which replicates the front panel key and display, but can be located remotely from the AdderView GEM. This is

particularly useful in applications where the AdderView GEM is located away from the desktop. The remote controller can be conveniently attached to your keyboard with a couple of Velcro strips to give instant channel information and key control.

3.3 Status display

The status display usually shows the currently selected port. If autoscan mode is selected, the segments will illuminate in sequence in a clockwise direction interspersed with a display of the currently selected channel. If AdderView GEM has been locked, 'P' will be displayed until a valid password has been typed to unlock the unit. Data flow from the mouse or keyboard causes the dot to flash.

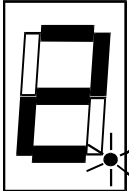
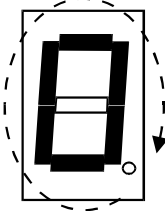
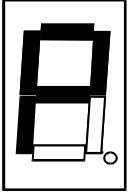
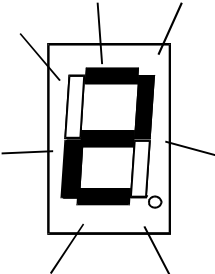
DISPLAY SHOWS		MEANING
Channel number displayed and dot in lower right hand corner flashes (0 indicates AdderView is disabled)		Activity on keyboard or mouse
Illuminated segment shifts clockwise with port number shown after each scan round		Auto-scan mode - scanning from channel to channel at rate as programmed by user
'P' prompt		Locked mode waiting for password to be entered
Display flashes port number		ADDERview is in screen save mode - keyboard, mouse or keypad activity will re-enable the video

3.4 Keyboard hotkey control

AdderView GEM can be conveniently controlled by selecting channel, autoscan mode or security locking from the keyboard. All of the hotkey control commands are invoked by holding down the two hotkeys and then pressing a command key. By default, the two hotkeys are 'CTRL' and 'ALT', although other combinations can be selected by reconfiguring the hotkeys (see section 4.4). Once the hotkey command has been activated you will need to release the hotkeys and the command key before a new hotkey command is accepted by the AdderView GEM. HOTKEYS + TAB is an exception and this allows you to 'tab through' the ports by holding down the hotkeys and repeatedly pressing TAB.

The hotkey command are summarised below (note that the numbers on the numeric keypad do not form part of a valid hotkey) :

'HOTKEYs' and '1' - selects channel 1

'HOTKEYs' and '2' - selects channel 2

'HOTKEYs' and '3' - selects channel 3

'HOTKEYs' and '4' - selects channel 4

'HOTKEYs' and 'TAB' - selects the next channel

'HOTKEYs' and 'A' - selects autoscan mode where each channel is displayed for the selected time (see section 4.2). To cancel autoscan mode simply select any fixed channel either by hotkey or using the AdderView GEM button.

'HOTKEYs' and '0' – switches off the video signal and displays 0. This will cause some monitors to go into standby mode or switch off. The video signal can be re-enabled by selecting a channel.











'HOTKEYs' and 'L' - disables the AdderView GEM's keyboard and mouse and displays 0. The video signal is switched off. If a password has not been set then the AdderView GEM can be re-enabled by selecting a channel. If a password has been set then the AdderView GEM displays 'P' to indicate that a valid password must be entered to unlock the switch. Simply type the same key combination as was set during configuration (see section 4.7) followed by the (return) key. Note - if anyone has typed at the keyboard whilst in secure mode, it will be necessary to type (return) first to clear the invalid password, then type the valid password followed by (return) again.

Examples of common hotkey sequences (assuming CTRL + ALT hotkey option):

To select channel 2:

press    release   



To 'tab through' channels:

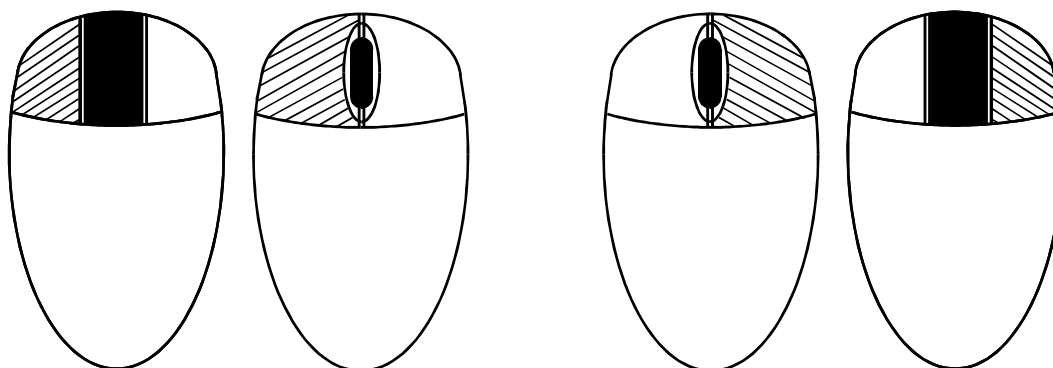

press    release  press 
release  press  release   

3.5 Mouse control

Computers may conveniently be selected using a three button mouse. In order to switch to the next computer simply hold down the central mouse button (the wheel mouse button on an IntelliMouse) and click on the left hand mouse button to select the next computer or the right hand mouse button to select the previous computer. If the AdderView has been set to scan active ports then the next or previous active channel will be selected. If it has been set to scan all ports then the next or previous numerical channel in sequence will be selected (see section 4.5 for more details). Mouse switching may be enabled or disabled by setting options during configuration (see section 4.3). When mouse switching is disabled the third button or wheel button state is 'passed through' the AdderView and seen by the application software.



Hold down centre button ()
Press and release left hand button
() to select next computer

Hold down centre button ()
Press and release right hand button
() to select previous computer

3.6 RS232 control

AdderView GEM can be controlled by a remote RS232 device. To select a channel the data rate of the sending device must be set to 1200 baud, 8 bits, no parity and 1 stop bit. No handshaking is used by the AdderView GEM. Simply send the character for the channel which needs to be selected, for example ASCII '1' (hex code 31) will select channel 1, ASCII '2' (hex code 32) will select channel 2 and so on. The AdderView will echo the ASCII character back to the sending device when the channel has been changed. The serial interface pins are found on the options connector on the rear of the AdderView. Pin assignments for this connector are given in appendix A.

3.7 Cascading AdderView GEMs

AdderView GEM switches can be connected together to expand the number of connected computers. When cascading AdderView GEMs a power adapter (AVGPSU) must be connected to each AdderView GEM. AdderView GEMs can be connected in a cascaded tree structure. This can be particularly useful where clusters of computers are located some distance from each other because each unit acts as data booster and can each be up to 30 metres away from the next AdderView GEM. The channel can be selected on remote AdderView GEM units using an extension of the HOTKEY control .

For example, consider a situation where two AdderView GEM units are connected together as shown below. To connect to the computer attached to port 3 on AdderView GEM B the user would hold down the hotkey keys then press '2' followed by '3', whilst keeping the hotkey keys pressed. This will have the effect of connecting to port '3' of the AdderView GEM which is connected into port '2' of the first AdderView GEM unit A.

For example to connect to port 3 on the AdderView GEM cascaded off port 2 of your first AdderView GEM use:

press    release 

press  release   

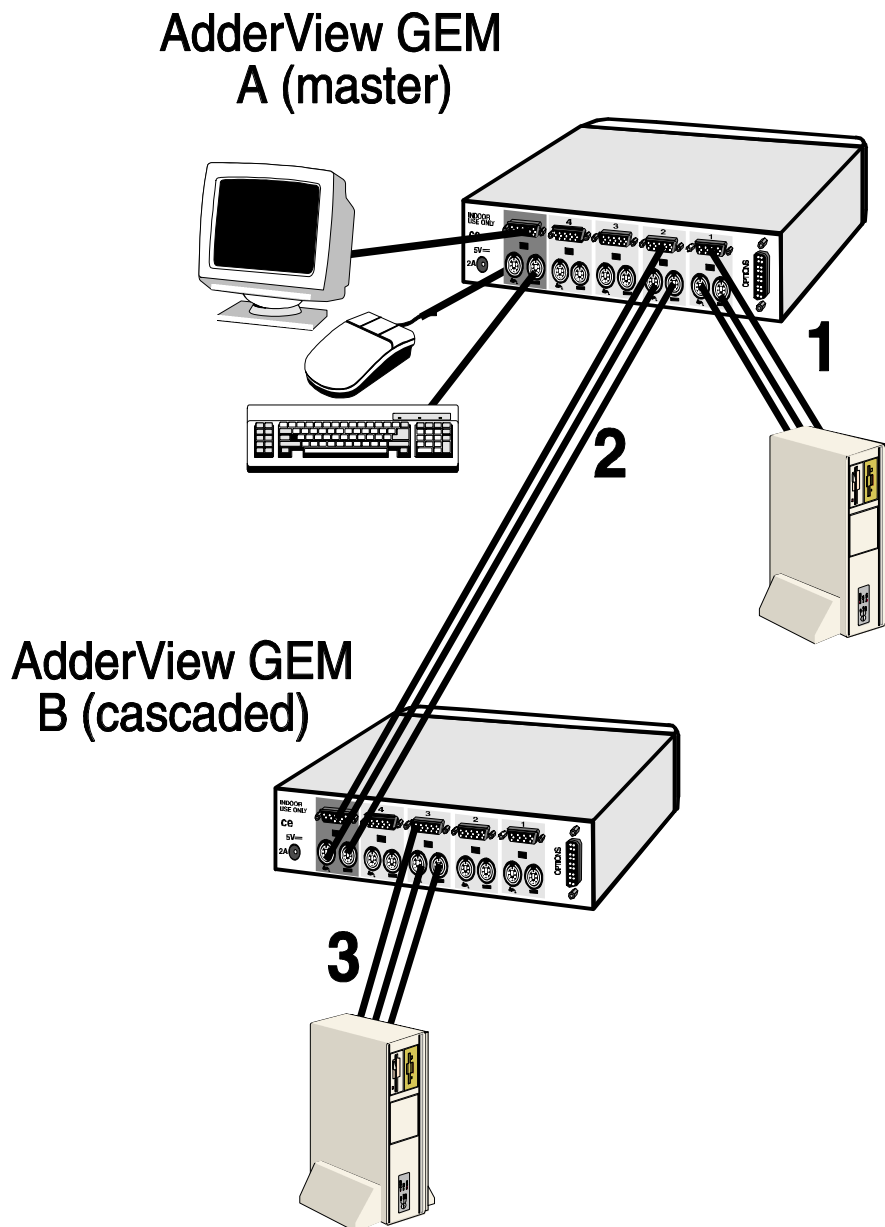

A typical cascade of two AdderView GEMs

3.8 Synchronising AdderView GEMs for multiple video head applications

Multiple AdderViews may be connected together so that they operate in a synchronised manner. Synchronised operation is useful for applications that require multiple video signals to be switched together. This type of operation is usually required where each computer is fitted with multiple video cards or video cards with multiple video heads. Such configurations are typically required in banking and engineering applications where greater video 'real estate' is required. Whenever the AdderView's channel is switched it sends an RS232 command out on its serial interface. The AdderView switches its channel if it receives the same command on

its serial interface. Consequently, by linking the serial interfaces a master unit may be made to automatically switch a daisy chain of slaved units as shown in the diagram below. The slave units will require the optional power adapters because they cannot draw their power from the video link alone.

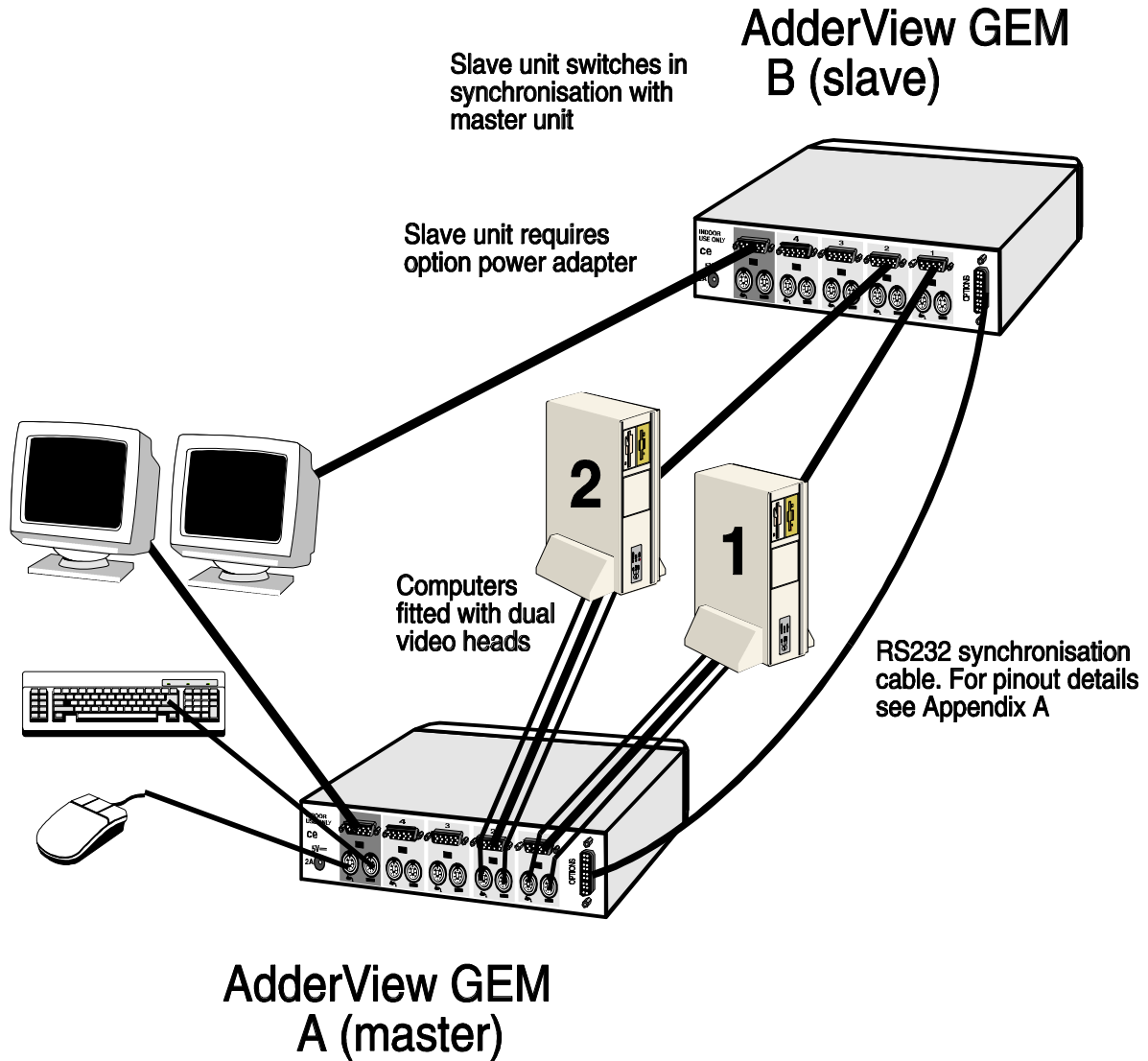

Synchronised AdderView GEMs used for a dual head video switching application

4. AdderView GEM configuration options

All the options described in this section are entered in AdderView GEM configure mode - see section 2.6 for instructions on entering configure mode.

4.1 Screen saver time delay

AdderView GEM contains a programmable screen saver which will blank the display after the set time delay with no keyboard or mouse activity. Simply typing at the keyboard or moving the mouse will re-enable the display. The display will flash whilst the AdderView GEM is in screen save mode.

- B1** - screen saver disabled (default)
- B2 - Blank screen after 1 minute of inactivity
- B3 - Blank screen after 2 minutes of inactivity
- B4 - Blank screen after 4 minutes of inactivity
- B5 - Blank screen after 8 minutes of inactivity
- B6 - Blank screen after 12 minutes of inactivity
- B7 - Blank screen after 16 minutes of inactivity
- B8 - Blank screen after 20 minutes of inactivity

4.2 Autoscan 'lock on' mode and delay time

AdderView GEM can be set to select each channel in turn for a period of time set by the autoscan delay time. Autoscan mode is entered by typing the hotkey keys together with 'A'. By default, only those channels which have a powered up computer connected to them will be scanned. Sometimes it may be desirable to scan all channels, even if the attached computer is switched off (this will simply show a blank screen when it is selected). All the AdderView GEM's ports will be scanned if option L2 is selected. Some applications may also require the AdderView GEM to power on in autoscan mode. This feature can be selected using the L3 or L4 options.

- L1 - AdderView GEM only locks on to active ports during autoscanning (default)
- L2 - AdderView GEM locks on to every port in turn during autoscanning
- L3 - AdderView GEM powers on in autoscan mode and locks on to active ports only
- L4 - AdderView GEM powers on in autoscan mode and locks on to all ports

- T1 - 2 seconds autoscan delay time before switching to next port (default)
- T2 - 5 seconds autoscan delay time before switching to next port
- T3 - 7 seconds autoscan delay time before switching to next port
- T4 - 10 seconds autoscan delay time before switching to next port
- T5 - 15 seconds autoscan delay time before switching to next port
- T6 - 20 seconds autoscan delay time before switching to next port
- T7 - 30 seconds autoscan delay time before switching to next port
- T8 - 60 seconds autoscan delay time before switching to next port

Note: Autoscan mode is ended simply by selecting a fixed channel using the keypad, the keyboard hotkeys or the mouse.

WARNING - Many modern monitors are fitted with automatic power save relays and will switch off after a few seconds if connected to an inactive PC. If you are using such a monitor you must not use the L2 feature. Constant switching on and off of your monitor's relay will eventually damage your monitor.

4.3 Mouse mode and mouse switching of channels

A three button PS/2 mouse or an IntelliMouse can be used to switch channels on the AdderView GEM. To switch to the next channel, the user simply holds down the central button or wheel button and presses the left or right hand button to change the channel (see section 3.5). If the user does not wish to take advantage of this feature, it can be disabled by selecting U2, U3 or U5. If the third button is being used to switch the AdderView GEM then it is not available for use with PC software although the function of an IntelliMouse wheel is not affected. Consequently in modes U1, U2 and U4 the AdderView GEM reports to the PCs that a 2 button mouse is connected. If you wish to use the full function of a 3 button mouse or IntelliMouse for your PC software then you should select options U3 or U5.

The AdderView GEM supports 'Internet Mice' that are compatible with the Microsoft IntelliMouse. These are fitted with a wheel or other scroll control and sometimes have additional buttons.

Examples are:

Microsoft IntelliMouse
Logitech Pilot Mouse +
Logitech MouseMan+
Genius NetMouse
Genius NetMouse Pro

Standard PS/2 and IntelliMouse compatible mice can be connected to the control port. You may configure your CPUs using Microsoft PS/2 or IntelliMouse drivers in any combination as required. The IntelliMouse features are supported on both PS/2 and RS232 CPU connections. When using PS/2 CPU connections, the AdderView GEM will automatically configure itself to the type of mouse requested by the driver. If you are using RS232 CPU connections then you will need to select mouse options U4 or U5 to enable the IntelliMouse features.

- U1** - AdderView GEM channels are switchable using a 3 button mouse or IntelliMouse (default)
(AdderView GEM reports 2 button mouse mode to PCs)
- U2** - AdderView GEM channels are not switchable using 3 button mouse or IntelliMouse
(AdderView GEM reports 2 button mouse mode to PCs)
- U3** - AdderView GEM channels are not switchable using 3 button mouse or IntelliMouse
(AdderView GEM reports 3 button mouse mode to PCs)
- U4** - AdderView GEM channels are switchable using 3 button mouse or IntelliMouse
(AdderView GEM reports IntelliMouse mode to PCs)
- U5** - AdderView GEM channels are not switchable using 3 button mouse or IntelliMouse
(AdderView GEM reports IntelliMouse mode to PCs)

4.4 Keyboard hotkey combination

The keyboard hotkey combination is used to change a channel, set autoscan mode or secure the product (so that the password needs to be typed before it can be used again). The following keyboard hotkey combinations can be selected. These hotkey combinations are used together with the command keys to trigger the required AdderView GEM function. The left and right shift key combination is particularly

suitable for extended keyboards where additional keys can be programmed to act as a combination of other keys. Such keyboards are supplied with many Gateway 2000 computers. Programming spare keys to trigger the hotkey combination allows channels to be selected via a single key stroke.

H1 - 'CTRL' and 'ALT' keys together (left or right hand keys operate) (default)

H2 - 'CTRL' and 'SHIFT' keys together (left or right hand keys operate)

H3 - 'ALT' and 'SHIFT' keys together (left and right hand keys operate)

H4 - 'RIGHT ALT' key

H5 - 'LEFT ALT' and 'RIGHT ALT' keys together

H6 - 'LEFT CTRL' and 'LEFT ALT' keys together

H7 - 'RIGHT CTRL' and 'RIGHT ALT' keys together

H8 - No hotkey enabled







4.5 Cycling between all channels or just the active channels



The AdderView GEM can be set to cycle between all channels or just the active channels when using 'Hotkeys + Tab' or a three button mouse to switch the channel. This avoids wasting time viewing channels that are not active. Option are:

U7 – Cycle between all ports when switching with 'Hotkeys + Tab' or three button mouse (default)

U8 – Cycle between active ports only when switching with 'Hokeys + Tab' or three button mouse

4.6 Firmware functions (version query, mouse restore and reset)

For technical support purposes, it may be necessary to find the firmware release version for the control software in your AdderView GEM. For example, if the release version is v1.29 the response shown to  will be a brief display of the digit '1', then  will be a brief display of the digit '2', then  will be a brief display of the digit '9'. You can reset all of the configured options back to the factory default states by typing . Use options  and  to restore mouse function on disconnected PS/2 CPU mouse connections.

- F1 - Display firmware first digit (Note: F1 is  followed by  NOT )
- F2 - Display firmware second digit
- F3 - Display firmware third digit
- F5 - Restore PS/2 mouse function to the currently selected CPU's mouse port
- F6 - Restore IntelliMouse function to the currently selected CPU's mouse port
- F8 - Reset all configurations to factory default settings. An 'r' will show briefly on the display to confirm that the reset has been completed.

4.7 Setting a security password

There are many situations where unrestricted access to corporate file servers or sensitive information needs to be controlled. In such circumstances, the AdderView GEM can be locked away in a room or secure cabinet and controlled remotely. In this mode typing the keyboard hotkeys together with 'L' will blank the screen, disconnect the keyboard and mouse from all of the computers and display 'P' on the AdderView GEM display. Control can only be regained by typing the correct password on the keyboard.

To set the password in configure mode, first type 'P' then (return). The display on AdderView GEM will change to show '=' and you can then type your password. The password is not case sensitive and can be any combination of key strokes, including the function keys, but excluding the (ctrl), (alt), (shift) and (return) keys. When you have typed in your password type (return) to register it in the stored memory. Do not worry if you type the password incorrectly, you can always re-enter configure mode and set the password again. If you have lost the password and the AdderView GEM is locked, the unit may be unlocked by powering down the AdderView GEM, entering configure mode at power on (see section 2.6), and performing a complete reset using the F8 function.

NOTE - The password consists of a combination of key strokes rather like the code to a safe. The key strokes are not case sensitive and can include all the keys on the keyboard (except ctrl, alt, shift and enter). Consequently the following 'password' would be valid:



4.8 Cascade query code

The AdderView GEMs use a special 'query code' to detect whether or not they are connected to another AdderView GEM. By default your AdderView GEM uses query code AD. SmartView (another range of keyboard / mouse / video switches from Adder Technology) units with firmware versions less than 1.09 used query code EF. This was found to conflict with a small number of other (rare) devices that used the same query code so an alternative query code was provided to ensure compatibility. Either query code may be used but you should make sure that all cascaded AdderView GEM and SmartView units are set to use the same query code. If any of the cascaded SmartViews have firmware versions less than 1.09 then the cascade query code for all the AdderView GEMs and SmartViews should be set to EF.

L7 – Cascade query code = AD (default)

L8 – Cascade query code = EF

4.9 Resolving slow mouse problems

Due to certain technical reasons some systems running particular combinations of operating system and mouse drivers are sensitive to small timing changes relating to mouse communications. The introduction of a switch like the AdderView inevitably causes some timing changes and in rare cases interactions have been observed that causes the mouse to run very slowly. Certain HP Vectra computers running later versions of Windows NT with Logitech mouse drivers and Logitech mice have been observed to exhibit such interactions with older switches. One solution to this problem is to change the mouse driver.

The AdderView GEM is a high performance device that is carefully engineered to minimise such interactions and should not exhibit this characteristic. Nevertheless such interactions are unpredictable and so the AdderView is fitted with a feature that ensures that the mouse can never operate at a very slow rate regardless of such interactions. This feature is activated using the following options:

L5 – Allow the mouse to run at any speed (default)

L6 – Don't allow the mouse to run at very slow speeds

4.10 Exit configure mode

When you have finished configuring any special options, simply type 'E' followed by (return) to exit configure mode and return to normal operation mode. The attached computers can now be switched on.

Appendix A. Cable and connector specifications

IMPORTANT NOTE

The maximum cable lengths supported vary widely between devices and cables. It may be possible to use cables that are longer than those specified below with certain PCs and peripherals but this cannot be guaranteed. If you experience problems try using shorter cables.

A1. Keyboard, monitor and mouse to AdderView GEM

All of the shared devices plug directly into the relevant ports at the rear of the AdderView GEM. If you use an AT style keyboard you will need an AT (5 pin DIN female) to PS/2 (6 pin mini-DIN male) converter.

Cable specification (self-powered operation):

Keyboard, monitor and mouse cables should be no longer than 2 metres.

Cable specification (with optional power adapter):

Keyboard, monitor and mouse extension cables can be used to increase the distance from AdderView GEM up to 10m. Most keyboards and mice will also operate at distances of 20 metres.

A2. AdderView GEM to PCs 1 to 4

Cable specifications:

Video - 15 pin high density male D connector to 15 pin high density male D connector wired as a standard VGA PC to monitor cable. There are two types commonly available. The best type cables which will give excellent quality are constructed with coaxial cable cores. Cheaper 'data' cables are often used, but can degrade video quality if used over longer distances. Avoid using 'data' cables longer than 2 metres unless the video quality is not important. Good quality coaxial video cables may be run at distances up to 30 metres with little loss of video quality. If you

wish to make use of the DDC (Display Data Channel) capabilities of the AdderView GEM then you will need to use cables that have the DDC signalling lines connected (pins 12 and 15 on the 15-way video connector). Not all video cables have these DDC lines connected.

Keyboard and PS/2 mice - 6 pin mini-DIN male connector to 6 pin mini-DIN male connector with all lines connected straight through (1-1,2-2 etc.). If the PC has a 5-pin DIN AT style keyboard connector you will need a PS/2 to AT keyboard adapter 6-pin mini-DIN female to 5-pin DIN male (readily available). For 'interface powered' operation without the optional power adapter the cables should be no longer than 5 metres (see section 2.4 for more details). For operation with the power adapter, cables should be no longer than 30 metres.

RS232 serial mice - these require a special converter to connect the RS232 lines present on the AdderView GEM mouse ports to the RS232 port on a PC.

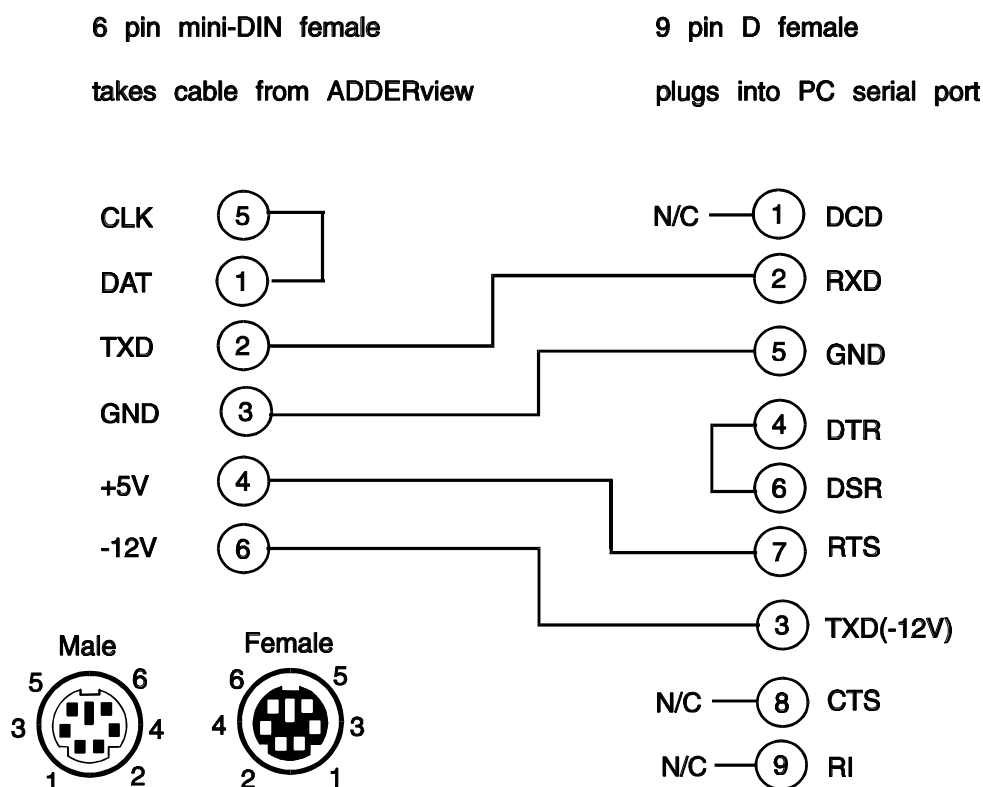

Cables should be no longer than 30 metres.

NOTE - There are several common wiring specifications for 6-pin mini-DIN to 9-pin serial adapters. If you have an adapter that has been supplied with a mouse it may have a completely different internal wiring to that shown above and may not be compatible with the AdderView

Recommended cables:

3-in-1 keyboard, video and mouse combination cable - For convenience, neatness and high video quality we recommend the Adder brand 3-in-1 combination cables. These cables are constructed with tri-coax video links to ensure that high video quality is maintained. They also support DDC signalling and are colour coded in PC99 specification colours for your convenience. These match the colours used on the back of your AdderView GEM and most modern PCs. These cables are available in various different lengths to suit your requirements. They may be purchased with or without the adapters for AT keyboards and RS232 serial mice. Please quote the following part codes when ordering from your supplier.

Part Code	Description
VKVM-2M	3-in-1 Adder cable, 2 metres long
VKVM-2M-AT	3-in-1 Adder cable, 2 metres long with AT and serial adapters
VKVM-5M	3-in-1 Adder cable, 5 metres long
VKVM-5M-AT	3-in-1 Adder cable, 5 metres long with AT and serial adapters
VKVM-10M	3-in-1 Adder cable, 10 metres long *
VKVM-10M-AT	3-in-1 Adder cable, 10 metres long with AT and serial adapters *

* The optional power adapter may be required (see section 2.4).

A3. Options port pin assignments

The 15 way D connector located on the back of the AdderView GEM (labelled OPTIONS / FLASH) provides connections for the remote control module and allows an external RS232 device to control the AdderView GEM. See section 3.6 for more details.

Pin 9 = GND

Pin 10 = TXD

Pin 11 = RXD

Other pins to be left unconnected

A.4 Flash upgrade cable connection

The cable connections shown below are to connect either COM1 or COM2 of a PC to the AdderView GEM to allow flash upgrades.

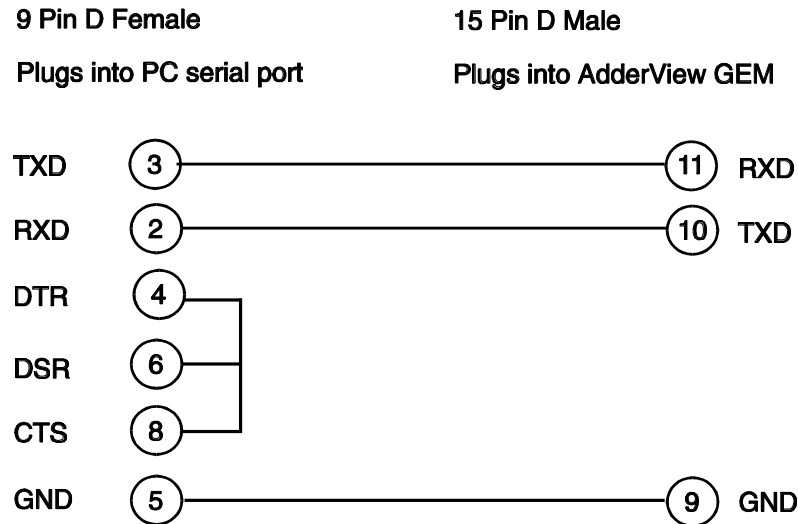

A.5 RS232 synchronisation cable pin assignments

The cable connections shown below are to connect two AdderView GEMs together for synchronised operation (see section 3.8)

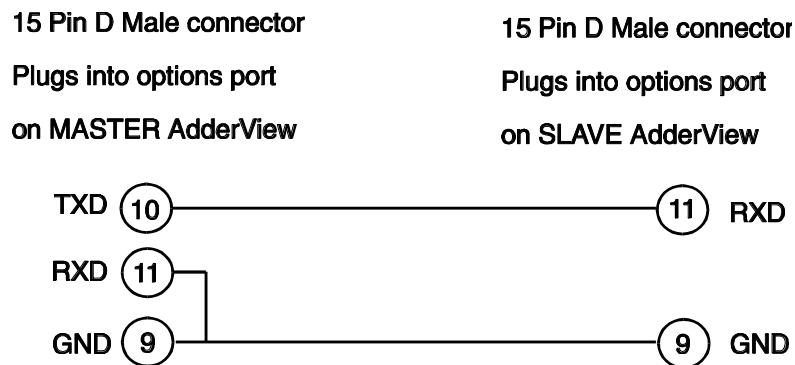

Appendix B. Problem Solving

Problem:

Poor video quality with smearing fuzziness or ripple.

Action:

Use screened coaxial video cables to connect your devices to the AdderView GEM.

Problem:

Mouse does not move cursor on screen.

Action:

Ensure that the mouse and computer are both connected to AdderView GEM before power is connected and ensure that the AdderView GEM is powered on before the attached computer. Ensure that your software is configured to accept a Microsoft compatible mouse of the type that you have connected (PS/2 or RS232). If you move the mouse and the activity indicator (dot on 7 segment display) does not flash then the AdderView GEM is not receiving data from the mouse. Check the mouse connection to the AdderView GEM, try resetting the mouse using the reset function (section 2.10) or re-powering the AdderView GEM. If you are attempting to connect the AdderView GEM to a CPU with a PS/2 mouse connection that has not been powered down then you will need to use the mouse restoration functions F5 or F6 (see section 2.11).

Problem:

Keyboard does not function or functions intermittently. Num lock light does not always come on when the num lock key is pressed.

Action:

Some older keyboards were designed for use with specific computers and are not truly AT or PS/2 compatible. These are not common but if you experience problems try another keyboard.

Problem:

Mouse causes channel to change.

Action:

Some cheaper mice are not fully compatible with the AdderView GEM and can lose data causing the channel to be changed (if mouse switching of channels is enabled). If you experience this problem then change the mouse and use a Microsoft, Logitech, IBM, Compaq or Hewlett-Packard type. Ensure that you are using a Microsoft compatible mouse driver on your PC. Some other manufacturers' drivers may switch the mouse to use a proprietary mouse data format not supported by the AdderView GEM. If you have unplugged and re-connected a mouse to the AdderView GEM then ensure that you reset it using the mouse reset function (see section 2.10).

Problem:

Mouse jumps around the screen after disconnecting the mouse cable or powering down the AdderView GEM.

Action:

If you have disconnected and re-connected a CPU mouse cable or you have powered down the AdderView GEM then the mouse data format may be out of synchronisation with that required by the PC (PS/2 or Intellimouse). Try the 'restore Intellimouse' function (F6) to resolve the problem or re-power the CPU.

Problem:

Mouse moves very slowly but otherwise functions correctly.

Action:

Change the mouse driver to a Microsoft type or take the action recommended in section 4.9.

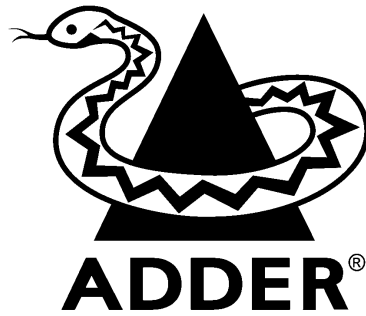

www.addertec.com