

## Enterprise IP Phone SIP-T22P

HD 



## About This Guide

Thank you for choosing this Enterprise IP Phone which is especially designed for power users in the office environment. It features fashionable and sleek design, abundant telephony applications, broad interoperability with the popular 3<sup>rd</sup> party VoIP products, fulfilling the VoIP deployment needs from enterprise and ITSP.

In this User Guide, you will find everything you need to quickly use your new phone. Be sure to verify with your system administrator that your network is prepared for configuring your IP phone. As well, be sure to read the Packing List section in this guide before you set up and use the phone.

### Declaration of Conformity



Hereby, it's declared that this phone is in conformity with the essential requirements and other relevant provisions of the CE, FCC.

### CE Mark Warning

This is a class B device, in a domestic environment; this product may cause radio interference, in which case the user may be required to take adequate measures.

### WEEE Warning



To avoid the potential effects on the environment and human health as a result of the presence of hazardous substances in electrical and electronic equipment, end users of electrical and electronic equipment should understand the meaning of the crossed-out wheeled bin symbol. Do not dispose of WEEE as unsorted municipal waste and have to collect such WEEE separately.

# Tables of Contents

<b>Getting Started.....</b>	<b>- 1 -</b>
Packing List .....	- 1 -
Assembling the Phone.....	- 3 -
Configuration and Registration.....	- 4 -
Configuring via Web Page .....	- 4 -
Configuring via keypad.....	- 6 -
<b>Overview .....</b>	<b>- 7 -</b>
Keypad Instruction.....	- 7 -
LED Instruction.....	- 8 -
Icon Instruction .....	- 9 -
User Interface.....	- 9 -
<b>Customizing Your Phone.....</b>	<b>- 12 -</b>
General Settings .....	- 12 -
Phone Status .....	- 12 -
Language.....	- 12 -
Time and Date .....	- 13 -
Keypad Lock.....	- 14 -
Audio Settings.....	- 15 -
Volume .....	- 15 -
Ring Tones .....	- 15 -
Codec Selection.....	- 16 -
Contact Management .....	- 17 -
Edit/Add/Delete Contact .....	- 17 -
Import/Export Contact list.....	- 18 -
Remote phone book .....	- 19 -
Other Settings.....	- 20 -
Key as Send.....	- 20 -
Hot Line .....	- 21 -
Anonymous call .....	- 21 -
Auto Redial .....	- 22 -
Auto Answer .....	- 22 -
Missed call log .....	- 23 -
Logo Customization.....	- 23 -
Dial Plan.....	- 24 -
Dial Now .....	- 24 -
Block Out.....	- 25 -
<b>Using the Basic Call Functions.....</b>	<b>- 26 -</b>

Making a call.....	- 26 -
Call Devices .....	- 26 -
Call Methods .....	- 26 -
Answering a call.....	- 26 -
Answering an incoming call.....	- 26 -
Denying an incoming call .....	- 27 -
DND.....	- 27 -
Call Forward .....	- 27 -
During an Active Call .....	- 28 -
Mute .....	- 28 -
Call Hold.....	- 28 -
Call Waiting .....	- 28 -
Call Transfer.....	- 29 -
3-way Conference .....	- 29 -
Message.....	- 30 -
Voicemail .....	- 30 -
SMS.....	- 31 -

## **Using the Advanced Phone Functions..... - 33 -**

Account Setting.....	- 33 -
TLS .....	- 34 -
Network Setting .....	- 34 -
PC Port Setting.....	- 34 -
VLAN Setting .....	- 35 -
HTTPS .....	- 36 -
Maintenance Tasks .....	- 37 -
Administrator Mode.....	- 37 -
Administrator/User Password .....	- 37 -
Reboot .....	- 38 -
Reset to Factory .....	- 38 -
Firmware Update.....	- 39 -
Decryption.....	- 40 -
System Log Export.....	- 41 -
Programmable Key Configuration .....	- 41 -
Line .....	- 42 -
Speed Dial.....	- 42 -
Intercom .....	- 42 -
Conference .....	- 43 -
Forward .....	- 43 -
Transfer .....	- 43 -
Hold.....	- 44 -
DND.....	- 44 -
Redial .....	- 44 -
Call Return .....	- 44 -

Group Pickup ..... - 45 -  
Call Park..... - 45 -  
Group Listening ..... - 45 -  
SMS..... - 46 -  
Voicemail ..... - 46 -  
Custom ..... - 46 -  
Tone Settings..... - 47 -  
Voice ..... - 47 -  
Ring..... - 48 -

**Trouble Shooting ..... - 49 -**

# Getting Started

## Packing List

The following components are included in your package:

- Enterprise IP Phone

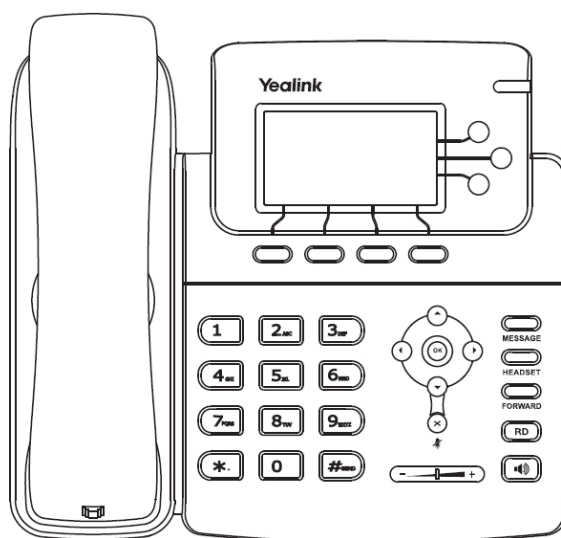

- Phone Stand

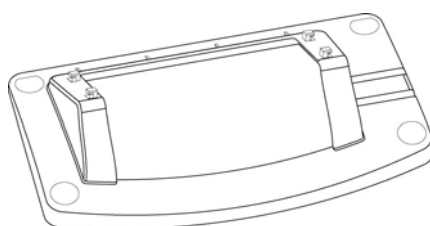

- Power Adapter

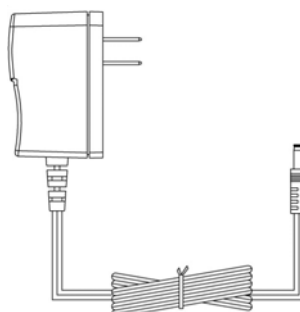

- Handset & Handset Core

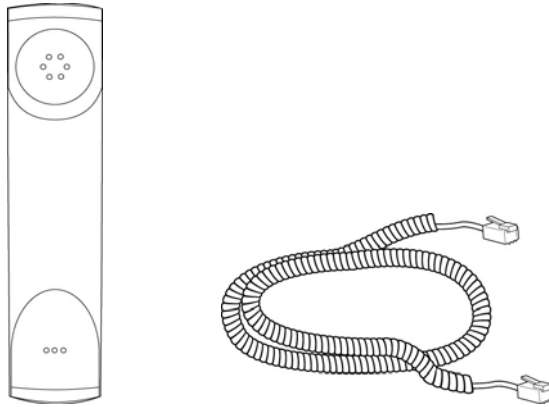

- Ethernet Cable

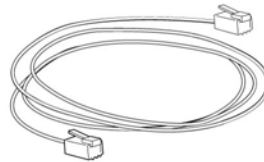

- Quick Installation Guide & Quick Reference

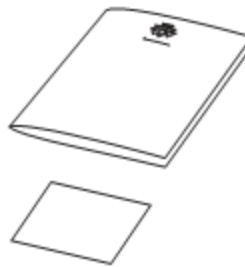

- CD Content



Check this list before installation to ensure that you have received each item. If you are missing any items, contact your IP phone reseller.

## Assembling the Phone

This section introduces how to assemble the phone with the components in the packing list:

- Attach the stand;
- Connect Handset and Headset;
- Connect Network and Power.

### 1) Attach the Stand, as shown below:

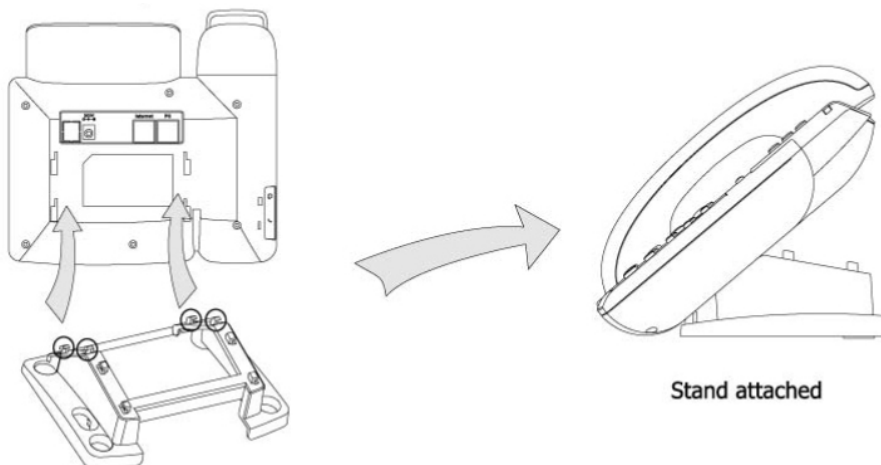

### 2) Connect Handset and Headset, as shown below:

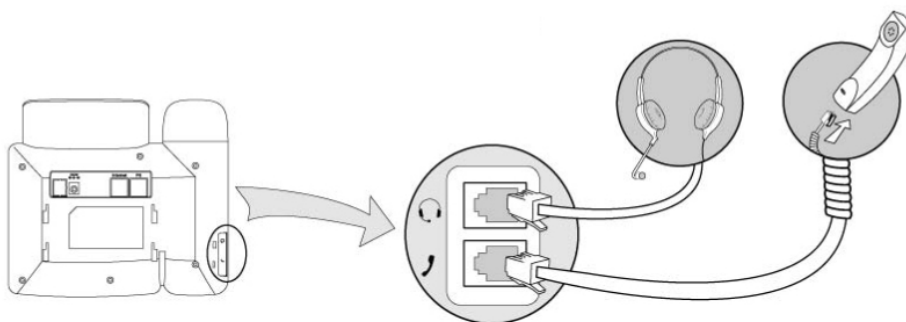

#### Note:

Headset is not provided in the packing list. Please contact your distributor for more information.

### 3) Connect Network and Power

There are two ways for network and power source connections. You can either connect the phone to the AC Power directly using the power adapter or to a PoE compliant switch or hub. Your system administrator will advise you on which one to use.

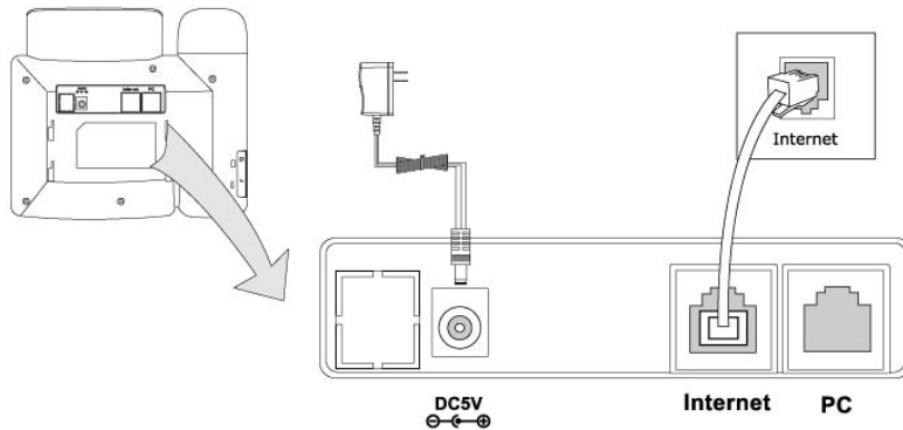

**Note:**

1. If inline power is provided, do not install AC adapter. Make sure the Ethernet cable and switch/hub are PoE compliant.
2. The Internet Port can be also connected to Hub/Switch/IP PBX or other internet devices.

The phone can also share the network connection with other network devices such as PC. Connect the phone's PC port and computer's Network Port together using an Ethernet cable, shown as below:

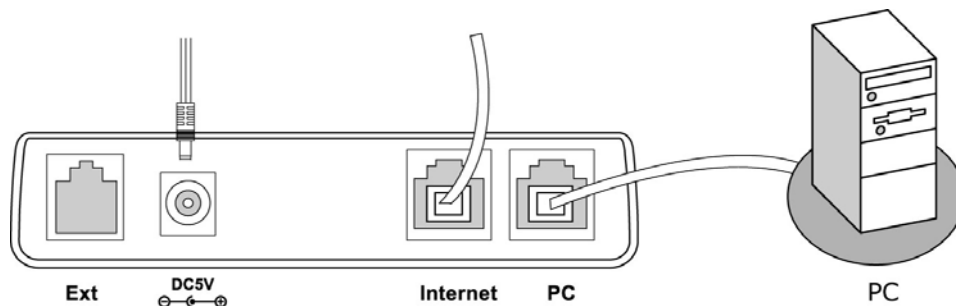

## Configuration and Registration

If you are administrator, you need to do some simple configuration to make the phone work. If not, please contact your internet administrator or service provider for more details.

### Configuring via Web Page

Press OK button on the keypad of the phone to enter the status page and find out the IP address of IP phone. Enter it (for example <http://192.168.3.35>) into the address bar of web browser. The default login name and password are both "admin".

**Note:**

Please locate your PC in the same network segment of IP phone (192.168.3.X) to access the web configuration page. Please consult your system administrator for help.

**Network Settings**

Choose Network->Internet Port.

**DHCP:** By default the phone attempts to contact a DHCP Server in your network in order to obtain its valid network settings, e.g. IP address, sub mask, gateway, DNS server, etc.

**Static IP Address:** If your phone cannot contact a DHCP Server for any reason, you need to enter the network settings manually via Static IP Address. Please contact your internet administrator for more details.

**PPPoE:** If you are using the xDSL Modem, you can connect your phone to the internet via PPPoE mode. Please contact your ISP for the User **Name** and **Password** for internet access.

**Note:**

Using the wrong network parameters may result in inaccessibility of your phone and may also have an impact on your network performance. Please contact your network administrator.

**Account Settings**

The phone attempts to register to the SIP server using the account/registrar data provided by the automatic or manual initialization.

Choose Account, you will find the following parameters:

Field	Description
<i>Register Status</i>	It shows the register status of the phone
<i>Line Active</i>	You can choose on/off to enable/disable the account respectively
<i>Label</i>	It is shown on the LCD for users to identify the account.
<i>Display Name</i>	It is shown as Caller ID when making a phone call
<i>Register Name</i>	It is authenticated ID for authentication, provided by ISP
<i>Account</i>	It is account for register, provided by ISP.
<i>Password</i>	It is provided by ISP for registration
<i>SIP Server &amp; Port</i>	Server for registration, provided by ISP

When you have finished the Network and Account Setting configuration, the Register Status Icons will show in the idle screen:



Registering

Registered successfully

Register failed

**Note:**

Should the IP PBX (SIP registrar) require an authentication, you will be prompted to enter the correct password. Make sure you are using the appropriate input method or enter the password via the web user interface.

## **Configuring via keypad**

**Network Settings:** Press Menu->Settings->Advanced Setting->Network ->WAN Port /PC Port/VLAN to enter the internet relating configuration page.

**Account Settings:** Press Menu->Settings->Advanced Setting->Accounts->Enter to configure the account settings.

You can refer to the above "Configuring via Web Page" for the parameter details.

# Overview

## Keypad Instruction

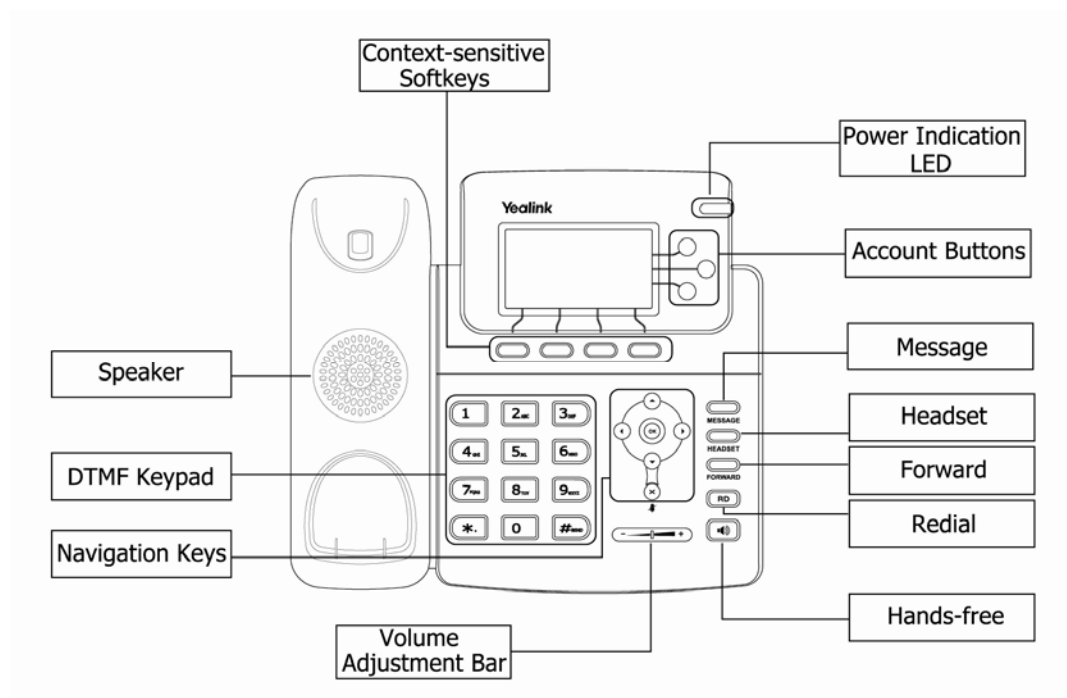

You can check the following list which introduces the IP phone's keypad in details:

### Power Indication LED

It will show the power status, it will be on if the phone is powered, off if the phone is not powered.

### Context-sensitive Softkeys

The screen will display labels for these keys, to identify their context-sensitive functions.

### Account Buttons

This buttons are used to active up to the three user accounts.

### Dial Pad

Use the DTMF hard keys to enter numbers, letters and special characters. Depending on the selected input mode, you can enter digits, lower / upper case or special characters.

### Navigation Keys

Use the navigation keys to navigate in the display menus and confirm and cancel actions.

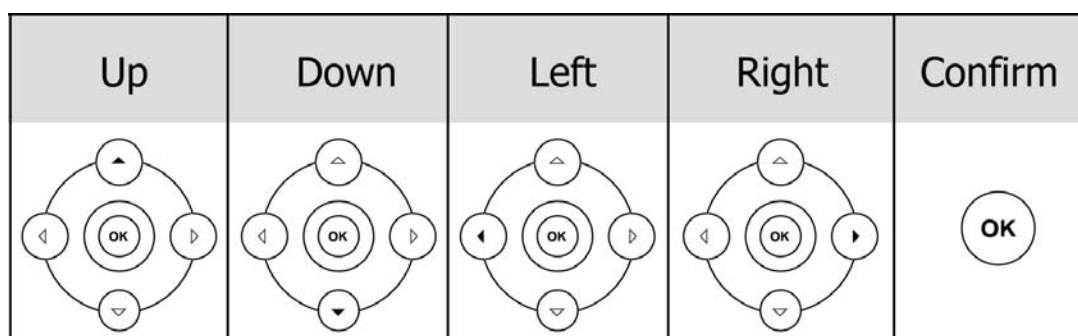

### Audio Device Control Keys

Use the audio device control keys to perform the following actions depending on your phone type:



: Adjust the volume of the handset, headset, speaker and ring tone;



: Allows for hands-free communication during calls;



HEADSET: Place and receive calls through an optionally connected headset.



: Mute audio transmission locally during calls;

### Hard Feature Keys



MESSAGE: Allow users to access the voicemail and SMS directly;



FORWARD: Forward the current call to third party;



: Dials most recently dialed number

## LED Instruction

Table 1 Account Button LEDs





















LED Status	Description
Steady green	The account is active
Blinking green	There is an incoming call to the account
off	The phone is in idle status whatever registered /unregistered

Table 2 Power Indication LED

LED Status	Description
Steady green	Power on
off	Power off

## Icon Instruction

The IP Phone displays different kinds of icons on its LCD, you can refer to the following table for their meanings:

Icon	Description
	Flashes when the internet is disconnected
	Account register failed
	Account registering
	Account register successful
	Missed calls
	Call in
	Call out
	Input Method: all letters and numbers
	Input Method: numbers
	Input Method: letters in lower case
	Input Method: letters in upper case
	Call mute
	Call hold
	Voicemail
	SMS
	Call forward
	DND(Do not Disturb)
	Auto answer
	In handset mode
	In headset mode
	In speakerphone mode

## User Interface

There are two ways to customize specific options on your phones:

1. Using keypad and display on the phone.
2. Using Web user interface in an Internet browser from your PC; please refer to "Configuration and Registration" to get into the Web interface.

In many instances, it is possible to use both the user interfaces to operate the phone and change settings; some, however, are only possible via a phone or web user interface. Please refer to the following table for differences:

Phone Options	Phone UI	Web UI
<b>Status</b>		
--IP Address		
--MAC Address		
--Firmware	√	√
--Network		
--Phone		
--Accounts		
<b>Call Features</b>		
-- Call Forward	√	
--Call Waiting	√	
--DSS Keys	√	
--"#" as send (Key as send)	√	
--Hot Line	√	√
--Anonymous Call	√	
--Auto Redial Setting	√	
--Dial Plan	√	
--Dial Tone		
<b>Basic Phone Functions</b>		
--Language	√	√
--Time	√	√
--Ring Tone	√	√
--Phone Volume	√	
--Lock	√	√
--Logo Customization		√
<b>Advanced Phone Functions</b>		
--Accounts	√	
--Networks	√	
--Voice		
--Codecs		√
--Echo Cancellation etc		
--Set Admin Password	√	
--Reset To Factory	√	
--Update		
<b>Other Features</b>		
--Message	√	
--History	√	√
--Contact List	√	
--Black List	√	

**Note:**

The above table only indicates most of phone functions rather than all of them. Please refer to the relating parts for more details.

**User and Administrator Mode**

Your phone can be used in user or administrator mode. Administrator mode is the default setting with full configuration rights. The default administrator password is **admin**.



# Customizing Your Phone

## General Settings

### Phone Status

You can view the status of your phone using the Phone interface or the Web interface. This option allows you to review:

- Network status: IP Address, Mac Address, Gateway, DNS, WAN and LAN;
- Phone status: Phone Name, Hardware version, Firmware version, Product ID, etc;
- Accounts: the 3 SIP accounts status;
- Firmware version;

To check the Phone Status via Phone interface:

- 1) Press OK button directly or Menu softkey, choose the Status option.
- 2) Use the navigation keys to scroll through the list and check the specific one.

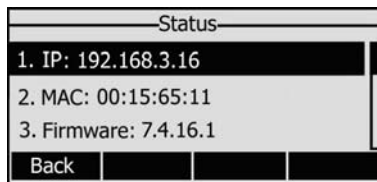

To view the Phone Status via Web interface:

Open the web browsers and input the IP Address `http://WAN-ip-address`; Enter the account and password (default account and password are both "admin"), choose Status directly to check the status.

### Language

The default Phone interface language is **English**. The Web interface language depends on your computer Operation System. It will automatically match the language with your computer.

It also supports Simplified Chinese, Traditional Chinese, French, German, Italian, Polish, Turkish, Portuguese, Spanish, etc. You can change the language for the phone user interface and the web user interface independently from each other.

**Note:**

All languages may not be available for selection. The available languages depend on the language packs currently loaded to the IP phone. Please contact with your system administrator for more information about loading language packs.

To change the language via Phone interface:

- 1) Press Menu->Settings->Basic Setting->Language.

- 2) Scroll through the list of available languages.
- 3) Press the Save softkey when the desired language is highlighted. The language appears on the graphic display will be changed to the one you chose.

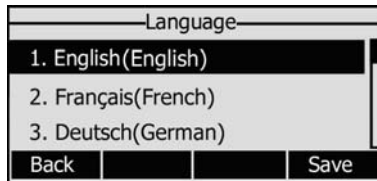

- 4) Press Back softkey to return to the previous menu.

## Time and Date

The time and date appears on the idle screen of the IP phone. If the phone can not obtain a time and date from the call server, please contact your system administrator if either the time or date is incorrect. You can set the time manually or via the SNTP server which is used to synchronize the time.

To change the Time and Date via the Phone interface:

- 1) Press Menu->Settings->Basic Setting->Time & Date.
- 2) If SNTP Settings is chosen, the phone will automatically get the time from the specific NTP Server. Use the navigation keys to highlight the specific option and the relating changes. You can set the Time Zone, NTP Server1/Server2, Daylight Saving respectively.

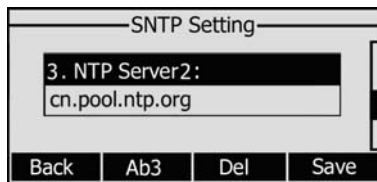

- 3) If Manual Setting is chosen, the time can be set manually. Use the navigation keys to highlight the option and enter the specific date and time.

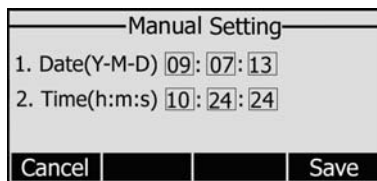

- 4) Press Save softkey, the time appears on the idle screen will be changed. Press Back softkey to return to the previous menu.

To set the time format via the Phone interface:

- 1) Press Menu->Settings->Basic Setting->Time & Date->Time Format.

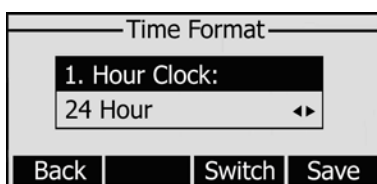

- 2) Use the Switch softkey to choose a preferred time format: 12 hour or 24 hour.
- 3) Press the Save softkey to save the changes and return to the previous screen.

To change the Time and Date via the Web interface:

Choose Phone->Preference to do the relating changes. You can also change the Update Interval which specifies the time frequency that the phone refreshes the time automatically. Please refer to the instruction above for the parameters' detail.

**Note:**

By default the time zone is **+8 China, Philippines, Malaysia**, Daylight Saving Time is disabled.

## Keypad Lock

You can lock the keypad of your phone when you are temporarily not using it. This function helps you to protect your phone from unauthorized use. You can lock the following specific keys:

*Menu Keys:* The Menu softkeys can not be used until unlocked. You can not access the menu of the phone.

*Function Keys:* The hard function keys can not be used until unlocked. You can not access the MESSAGE, HEADSET, CONF, HOLD, MUTE, TRAN, RD Keys.

*Talk Call Only:* All of the keys can not be used until unlocked. You can only use the phone to answer the incoming calls.

*Answer Call Only:* You can only use the phone to answer the incoming calls (But can not hung up the call by your party. Or enter the menu pages to do some configurations.

To enable keypad lock via Phone interface:

- 1) Press Menu->Settings->Advanced setting, enter the password, and then press Enter softkey.
- 2) Choose Phone Lock, and then press Enter softkey.
- 3) Use the navigation key to highlight the one you want to lock.

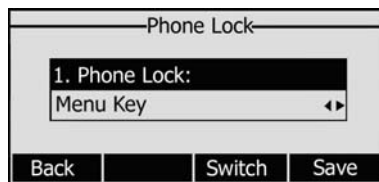

- 4) Press Save softkey to active the change, or Back to return to the previous screen.
- 5) The icon  will be displayed on the top right corner of the idle screen.

To unlock the phone via Phone interface:

- 1) Press Menu softkey, you are prompted for the password.
- 2) Enter the password, then press Confirm softkey, the phone is unlocked.
- 3) The icon will be disappearing from the idle screen.

To enable keypad lock via Web interface:

Choose Phone->Preference to do the relating changes. Please refer to the instruction above for the parameters' detail.

**Note:**

1. The default password for unlock is **admin**.
2. Users can make emergency calls when the phone is locked.

## Audio Settings

### Volume

You can adjust the volume of handset/speaker/headset.

To adjust the volume when you are not in an active call:

- 1) Press Menu->Settings->Basic Setting.
- 2) Scroll to Phone Volume, and press Enter softkey, highlight the one you want to adjust the volume, use the Volume Adjustment Bar or navigation keys to adjust the volume.

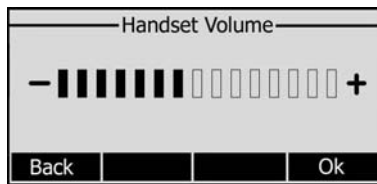

- 3) Press OK softkey to save the changes or Back softkey to cancel the operation.

To adjust the volume when you are on an active call:

When Handset/Headset/Hands-free mode is activated, press the Volume Adjustment Bar to a comfortable level.

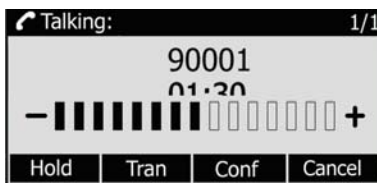

**Note:**

The volume can only be adjusted via Phone interface.

### Ring Tones

You can adjust the type and volume of the ring tone.

To adjust the Ring Tone Type via Phone interface:

- 1) Press Menu->Settings->Basic Setting.
- 2) Scroll to Ring Tone, and press Enter softkey.
- 3) Use the navigation keys to highlight the specific one.

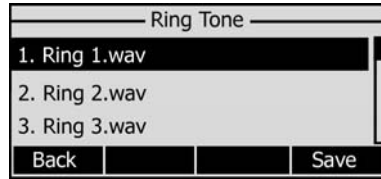

4) Press OK softkey to save the change or Back softkey to cancel.

To adjust the volume via Phone interface:

- 1) Press Menu->Settings->Basic Settings->Enter.
- 2) Scroll to Phone Volume->Ring Volume, use the Volume Adjustment Bar or navigation keys to adjust the volume.

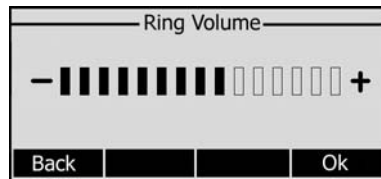

3) Press OK softkey to save the change or Back softkey to cancel.

You can also adjust the ring tone volume by the following way:

When the phone is in idle status, press the Volume Adjustment Bar to a comfortable level.



To change the Ring Tone Type via Web interface:

Choose Phone->Preference->Ring Tone, highlight the specific one in the scroll-down menu, choose confirm button to update the change. You can also delete the specific one by pressing Delete button.

**Note:**

The ring tone file of system can not be deleted.

To update the new Ring Tone via Web interface:

- 1) Choose Browse button to choose the specific ring tone file.
- 2) Choose Upload button to upload the file, and then Confirm to save the change.

**Note:**

1. The ring tone file format must be in 16bits WAV format (via Ulaw Compression), 8K sample rate (monophony).
2. Blank or other special characters can not be included in the file name.
3. The upload ringtone file can not exceed 100K totally.

## Codec Selection

The IP phone supports the following voice codecs:

G.722, G.711, G.723.1, G.726, G.729AB, iLBC and GSM.

You can enable/disable the desired codecs via Web interface. Please contact your System Administrator for more details about the codecs.

To enable/disable the codecs:

- 1) Choose Account->Account X (X means Account number) ->Codecs.

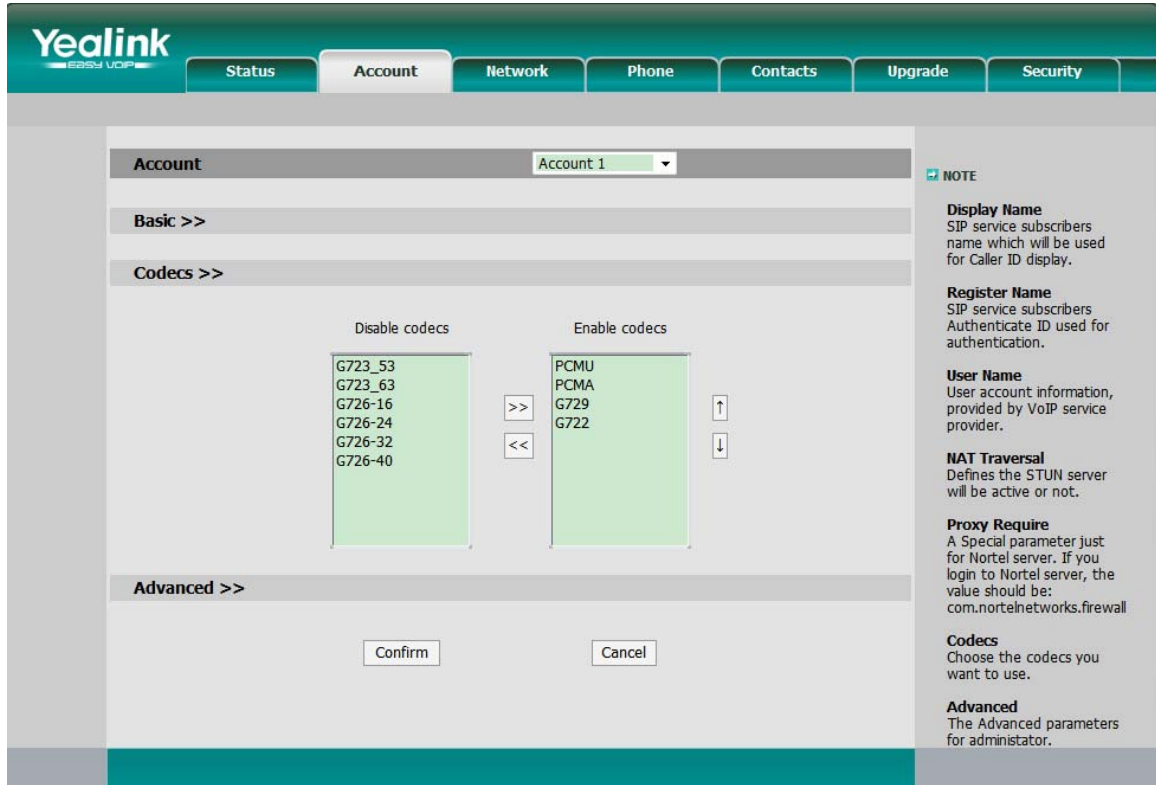

- 2) Use the navigation keys to highlight the desired one in the Enabled/Disable Codecs list, and press the >> / << to move to the other list.

- 3) Choose Confirm to save the change.

**Note:**

Codec Selection can be only set via Web interface.

## Contact Management

### Edit/Add/Delete Contact

You can store a large number of contacts in your phone's directory. You can add, edit, delete, dial, and search for a contact in this directory.

To add a contact via Phone interface:

- 1) Press Addr->Contact List->Enter.
- 2) Press Add softkey; enter Name, Office/Mobile number of the contact from the keypad. Use the 123 soft key to select between numeric and upper/lower case alphanumeric modes.

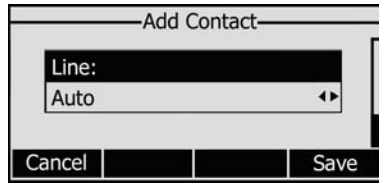

- 3) Use the navigation keys to select the desired account as Line if you want to assign the contact to a specific account.
- 4) Press Save softkey to add the contact or Cancel softkey to cancel the change.

To edit/delete a contact via Phone interface:

- 1) Press Addr->Contact List->Enter.
- 2) Use the navigation key to highlight the one you want to delete, press Option softkey, and scroll to Detail/delete, press OK softkey.

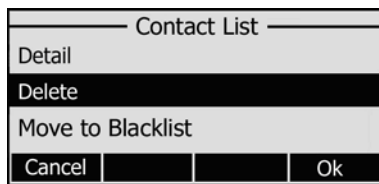

- 3) Make the desired changes, press OK softkey, or press Cancel softkey to return to the Directory.

To move a contact to the blacklist via Phone interface:

- 1) Press Addr->Contact List->Enter
- 2) Use the navigation key to highlight the one you want to move, press Option softkey, scroll to move to Blacklist, press OK softkey twice to confirm the change, or press Cancel softkey to return to the Directory.

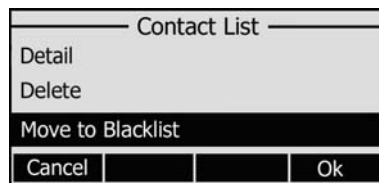

- 3) Press Menu->Address Book->Black List to check and change the black list record.

**Note:**

If a contact is moved to the blacklist, then the call from this contact can not get through.

To add/delete/edit the contact list & black list via the Web interface:

Choose Contacts and then do the relating changes. Please refer to the instruction above for the parameters' detail.

## Import/Export Contact list

Import/Export Contact List via Web interface:

- 1) Choose Contacts->Local phone book.

**NOTE**

**Add Contact/Blacklist**  
Put in the informations about contact. User shouldn't leave contact name blank.

**Delete Contact/Blacklist**  
Select the contact you want to delete in the grid, and then press the button Delete to submit.

**Move to Contact/Blacklist**  
Choose one list you want to move in the grid, and press the button move to Contact/Blacklist to move it.

**Import**  
Browse the file in XML format.

**Export**  
Click Export button and create a file with he name you like.

- 2) Browse the specific contact list file in .XML format, and then choose Import button. The imported contact lists will be shown in the Contact List.
- 3) Choose the Export button to export the contact list.

**Note:**

Import/Export Contact List can be only set via Web interface.

## Remote phone book

The IP phone has address book itself. But in the enterprise application, often there will release a common address book. For the purpose of maintenance and updating, the common address book is usually carried out on the server or IPPBX, so that in order to maintain up-to-date public address book, terminals need to have remote address book function. When the users browse the remote address book, the terminal will check and download the latest information released on the server in time, and display on the terminal for the users.

To set the Remote phone book via Web interface:



- 1) Choose Contacts-> Remote phone book.

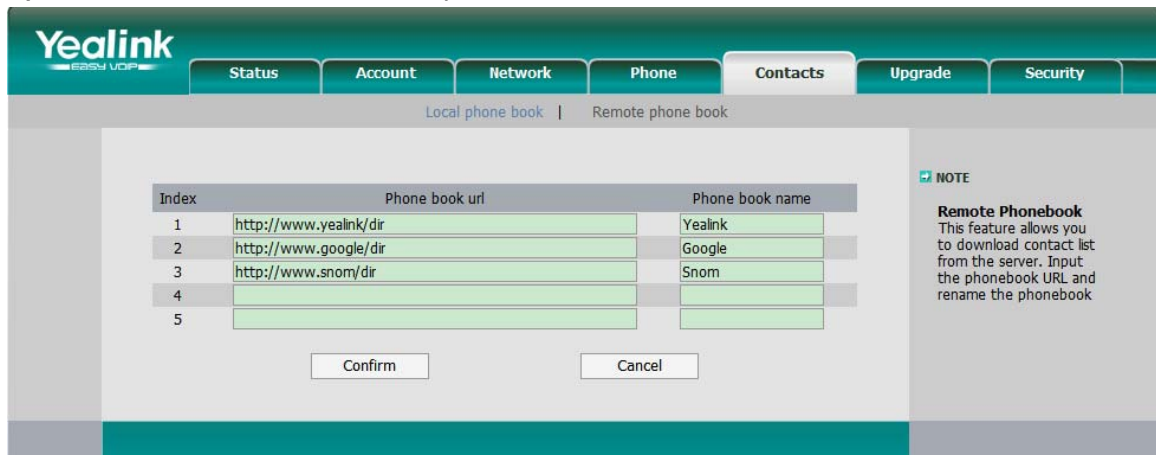

- 2) Input the Phone book URL and the phone book name, then click the Confirm button to save the changes.
- 3) After the setting, go to the Address Book via phone interface, you will see the remote address book you have just added:

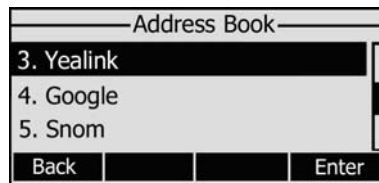

- 4) Choose a specific one, and press the Enter softkey, it will go to the corresponding URL address to download the contact information for you.

**Note:**

This IP phone can support 5 remote phone books at most.

## Other Settings

### Key as Send

Users can set a specific button (“#” or “\*”) to active as the send button.

To set the send key via the IP phone interface:

- 1) Press Menu->Features->Key as send->Enter to enter the configuration page.

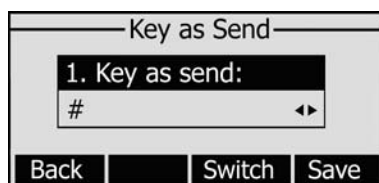

- 2) Press the Switch softkey to choose a button that you want to use as the send key: “#”, “\*”, or disable this option.
- 3) Press the Save softkey to save the changes.

To set the send key via the Web interface:

- 1) Choose Phone-> Features-> Key as send.
- 2) Highlight the specific one in the pull-down menu, click confirm button to save the change.

## Hot Line

To set the hot line number via the IP phone interface:

- 1) Press Menu->Features->Hot Line->Enter to enter the configuration page.

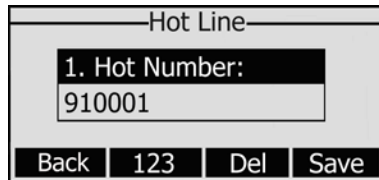

- 2) Enter the hot line number and press the Save softkey to save the changes.
- 3) When you pick up the handset or press the speaker button, it will dial out the number automatically.

To set the Hot Line via the Web interface:

- 1) Choose Phone-> Features.
- 2) Input the hotline number, then click the Confirm button to save the change.

## Anonymous call

To set the anonymous call via the IP phone interface:

- 1) Press Menu ->Features-> Anonymous Call ->Enter to enter the configuration page.

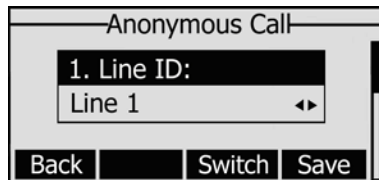

- 2) By the Switch softkey, you can choose the Line ID.
- 3) Press the navigation keys to enter and choose whether to enable the anonymous call function. This feature allows the subscriber to make a call with the display of their calling identification information blocked.

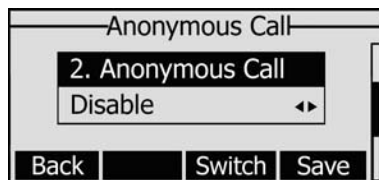

- 4) Press the navigation keys to enter and choose whether to enable the anonymous rejection function. The feature allows the subscriber to reject all calls from callers who have blocked the display of their calling identification information (calling number and calling name).

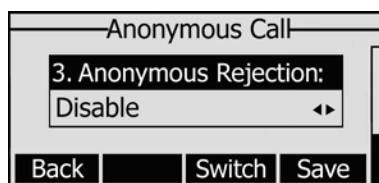

- 5) Press the Save softkey to save the changes.

## Auto Redial

Auto redial is a telephone feature that redials a busy number a fixed number of times before giving up.

To set auto redial via the IP phone interface:

- 1) Press Menu->Features->Auto Redial Setting->Enter to enter the configuration page.

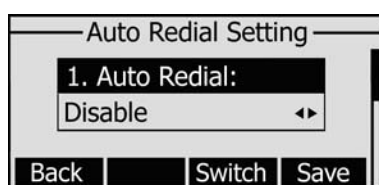

- 2) By the Switch softkey, you can choose whether to enable the auto redial function.
- 3) Press the navigation keys to choose and set the redial interval. It is measured by seconds.

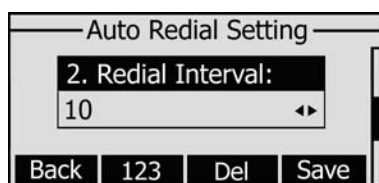

- 4) Press the navigation keys to choose and set the redial times.



- 5) Press the Save softkey to save the changes.

To set auto redial via the Web interface:

- 1) Choose Phone-> Features-> Auto Redial.
- 2) Choose Enabled or Disabled in the pull-down menu, click confirm button to save the change.

## Auto Answer

Auto-answer allows an incoming call to be answered without requiring any action by the user. This is a useful feature for people who have difficulty using their hands or fingers,

who have a visual impairment, or who have a cognitive impairment. You can set this function to a special account.

To set Auto Answer via the IP phone interface:

- 1) Press Menu->Settings->Advanced Setting->Accounts->Line X, use the navigation keys to choose Auto Answer option.

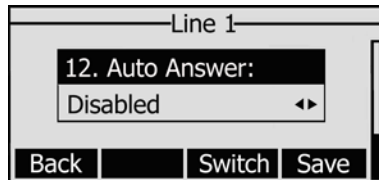

- 2) Press the Switch softkey to enable or disable the auto answer function. The default is Disabled.
- 3) Press the Save softkey to save the changes.

To set Auto Answer via Web interface:

- 1) Choose Account-> Basic-> AutoAnswer.
- 2) Choose Enabled or Disabled in the pull-down menu, click confirm button to save the change.

## Missed call log

Defines whether to save the missed calls to the call history record. This function can only be set via the Web interface:

- 1) Choose Account-> Basic->Missed call log.
- 2) Choose Enabled or Disabled in the pull-down menu, click confirm button to save the change.

## Logo Customization

You can upload your own logo which displayed on the idle screen.

- 1) Prepare the desired the logo file which is
  - in BMP format,
  - max pixels: 132\*64,
  - black & white picture.
- 2) Run PictureExDemo.exe, click Add button-> choose the specific logo file->click Convert, and then close the software.
- 3) A new-built folder named adv with a .dob file will be created.
- 4) If you want to add more logos to your phone, you can follow the above steps to repeat the operation.
- 5) There will be an advertising.index file in the created adv file, open it and you can edit the show time of the specific logo, the units is millisecond. For example: log2.dob,3000 means the logo 2 will show 3 seconds on the LCD.
- 6) Run the adv.bat, it will create a new-built folder named adv.tar.gz.
- 7) Choose Phone->Function->Logo via the Web interface, press Browse button, and

choose the adv.tar.gz file just created by the software.

- 8) Press Upload button to complete the Logo Customization. You will find the desired logo display on the idle screen.

**Note:**

Please contact with your system administrator or service provider for the software PictureEXDemo.exe.

## Dial Plan

A dial plan establishes the expected number and pattern of digits for a telephone number. This includes country codes, access codes, area codes and all combinations of digits dialed. For example if you set the *Prefix* as 0 and *Replace* as 0086 (Chinese country code), when you dial 05702000 out, the number will be replaced by 00865702000 automatically.

To set a Dial Plan via the Web interface:

- 1) Choose Phone->Dial Plan->Replace Rule.

**Replace Rule >>**

Index	Prefix	Replace
1		<input type="checkbox"/>
2		<input type="checkbox"/>
3		<input type="checkbox"/>
4		<input type="checkbox"/>
5		<input type="checkbox"/>
6		<input type="checkbox"/>
7		<input type="checkbox"/>
8		<input type="checkbox"/>
9		<input type="checkbox"/>
10		<input type="checkbox"/>

Prefix  Replace

**Dial-now>>**  
**Area Code>>**  
**Block Out>>**

**NOTE**

**Digit 0-9 \***  
Identifies a specific digit (do not use #).

**[digit-digit]**  
Identifies any digit dialed that is included in the range.

**[digit-digit,digit]**  
Specifies a range as a comma separated list. Please notice that only brock out rule support this method.

**x**  
Matches any single digit that is dialed.

**.**  
Matches an arbitrary number of digits.

- 2) Enter the desired *Prefix* and *Replace*.
- 3) Click Add button to save the changes.
- 4) You can also delete a specific one from the dial plan list.

**Note:**

Please contact with your system administrator for the country/area code if you want to set the dial plan.

## Dial Now

Dial-now enables you to define the specific length of any number/letter in advance(for

example xxx), next time when users dial out the 123 whose length matches the Dial-now rule, the phone will dial out 123 immediately without pressing Send button.

To set a Dial Plan via the Web interface:

- 1) Choose Phone-> Dial Plan->Dial Now.

**Replace Rule >>**

**Dial-now>>**

Index	
1	<input type="checkbox"/>
2	<input type="checkbox"/>
3	<input type="checkbox"/>
4	<input type="checkbox"/>
5	<input type="checkbox"/>
6	<input type="checkbox"/>
7	<input type="checkbox"/>
8	<input type="checkbox"/>
9	<input type="checkbox"/>
10	<input type="checkbox"/>

Dial-now Rule:

**Area Code>>**

**Block Out>>**

**NOTE**

**Digit 0-9 \***  
Identifies a specific digit (do not use #).

**[digit-digit]**  
Identifies any digit dialed that is included in the range.

**[digit-digit,digit]**  
Specifies a range as a comma separated list. Please notice that only brock out rule support this method.

**x**  
Matches any single digit that is dialed.

**.**  
Matches an arbitrary number of digits.

- 2) Enter the desired "x/."
- 3) Press Add button to save the changes.
- 4) You can also delete a specific one from the dial plan list by pressing Del button.

**Note:**

x represents any numbers; . represents any letters.

## Block Out

The specific phone numbers can be forbidden to be call out from your IP phone.



- 1) Choose Phone->Dial Plan->Block Out.
- 2) Enter the phone number and choose Add button to save the changes, or Choose the specific one in the list, choose Delete button to delete the record.
- 3) You can not dial out the number from your IP phone unless it is removed from the Forbidden List.

# Using the Basic Call Functions

## Making a call

### Call Devices

You can make a phone call via the following devices:

- 1) Pick up the handset,  icon will be shown in the idle screen.
- 2) Press the Speaker button,  icon will be shown in the idle screen.
- 3) Press the Headset button if the headset is connected to the Headset Port in advance. The icon  will be shown in the idle screen.

You can also dial the number first, and then choose the method you will use to speak to the other party.

### Call Methods

You can press an available line button if there is more than one account, then

- 1) Dial the number you want to call, or
- 2) Press the Adrr softkey, use the navigation button to highlight your choice, or
- 3) Press History softkey, use the navigation button to highlight your choice (press Left/Right button to chose All Calls, Missed Calls, Dialed Calls, Received Calls and Forwarded Calls) or
- 4) Press the RD button to call the last number called.
- 5) Press the programmable keys which are set as speed dial button.

Then press the Send button or Send softkey to make the call out if necessary.

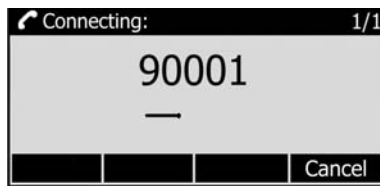

## Answering a call

### Answering an incoming call

- 1) If you are not on another phone, lift the handset using, or press the Speaker button/ Answer softkey to answer using the speakerphone, or press the headset button to answer using the headset.
- 2) If you are on another call, press the Up/Down navigation keys to enter the incoming call interface, then press Answer softkey to answer it.



During the conversation, you can alternate between Headset, Handset and Speaker phone by pressing the corresponding buttons or picking up the handset.

## Denying an incoming call

Press Reject softkey to deny the incoming call directly.

## DND

Press DND softkey to active DND Mode when the phone is in idle status. Further incoming calls will be rejected and the display shows:  icon. Press it again, or picking up the handset to deactivate DND mode. to deactivate DND mode. You can find the incoming call record in the Call History.

## Call Forward

This feature allows you to forward an incoming call to another phone number e.g. a cell phone or voice mailbox. The display shown  icon.

The following call forwarding events can be configured:

- *Off:* Call forwarding is deactivated by default.
- *Always:* Incoming calls are immediately forwarded.
- *Busy:* Incoming calls are immediately forwarded when the phone is busy.
- *No Answer:* Incoming calls are forwarded when the phone is not answered after a specific period.
- *Busy/No Answer:* Incoming calls are forwarded not matter the phone is busy or not answered.

To configure Call Forward via Phone interface:

- 1) Press the following softkeys: Menu->Features->Enter->Call Forward->Enter.
- 2) There are 5 options: Always Forward, Busy Forward, No Answer Forward, Busy/No Answer Forward, Cancel Forward.
- 3) If you choose one of them (except Cancel Forward), enter the phone number you want to forward your calls to. Press Save to save the changes.

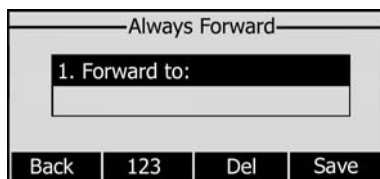



To configure Call Forward via Web interface:

Choose Phone->Features->Call Forward to do the relating changes. Please refer the above configuration information.

## During an Active Call

### Mute

This function allows you to mute the microphone of the active audio device during a call; you can not be heard by the other party. You can still hear all other parties while mute is enabled.

To mute/unmute the conversation:

Press Mute button during the conversation,  icon will shown in the LCD. Press it again to get the microphone return to normal conversation.

### Call Hold

This call function allows you to place an active call on hold. In this case your IP PBX might play a melody or message to the other party while waiting. Other calls can be received and made while having a call on hold.

To hold/resume a call:

- 1) Press the Hold button or Hold softkey to put your active call on hold.
- 2) If there is only one call on hold, press the Resume softkey or Hold button to retrieve the call.

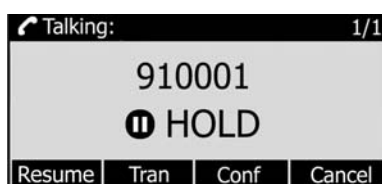

- 3) If there are more than one call on hold, press the line button, press the Up/Down button to highlight the call, press the Resume softkey or Hold button to retrieve the call.

**Note:**

When you are under the call hold status, putting down the handset, the conversation will go on over the speaker instead of hanging up the call.

### Call Waiting

This call feature allows your phone to accept other incoming calls to an extension already in an active call.

To enable/disable Call Waiting via Phone interface:

- 1) Press Menu->Features->Call Waiting->Enter softkeys.
- 2) Use the navigation keys or Disable/Enable softkey to active/inactive call waiting.

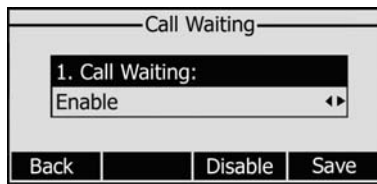

- 3) Press Save softkeys to save the changes, or Back softkey to return to the previous menu.

To enable/disable Call Waiting via Web interface:

Choose Phone->Function->Call Waiting to do the relating changes.

## Call Transfer

You can customize your phone so that incoming calls are transferred directly to a third party such as another extension, mobile phone number, etc. There are two ways to transfer the call: Blind Transfer and Attended Transfer.

To Blind Transfer via Phone interface:

- 1) Press Tran Button or Tran softkey during the active conversation, the call will be on hold, there will be a dial tone. Dial the second telephone number.



- 2) Hang up to complete the transfer.
- 3) You will be disconnected from the call.

To Attended Transfer via Phone interface:

- 1) Press Tran Button or Transfer softkey during the active conversation, the call will be on hold, there will be a dial tone. Dial the second telephone number.
- 2) When the phone is answered, you can have a private conversation without the first person hearing it, then hang up to complete the transfer.
- 3) You will be disconnected from the call.

## 3-way Conference

You can establish a three-party conference, during the conversation three phone parties can communicate with each other.

To establish a conference:

- 1) Press the Conf softkey during an active call.
- 2) The first call is placed on hold. You will hear a dial tone. Dial the number to conference in, then press the Send softkey.



- 3) When the call is answered, the conference call will now include you and the other two parties.
- 4) Hang up to disconnect all parties.

## Message

The phone supports SMS( Short Messaging Service) and Voicemail, if you want to use them, please make sure that your VoIP telephony system supports this functionalities and your accounts' message has been enabled.

## Voicemail

Your voice mailbox messages, which are usually stored on a media server of your local or hosted VoIP telephony system, can be accessed from your phone.

New voice messages can be indicated both acoustically and visually as described below:

- The idle screen will indicate the new voice messages coming:
- The MESSAGE button will be lighted.

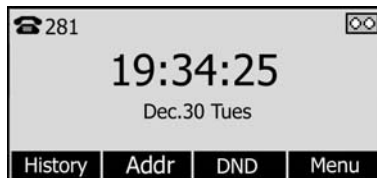

To configure the Voicemail code via Phone interface:

- 1) Press MESSAGE button, scroll to Voice Mail, press Enter softkey
- 2) Use the navigation keys to highlight the one you want to set, enter the code which the phone uses to connect to your system. Press 123 softkey to choose the proper input method.

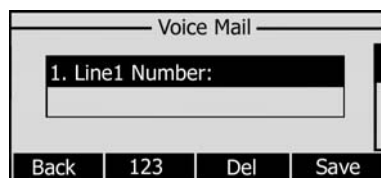

- 3) Press Save to save the change, press Back to return to the previous menu.

### Note:

Please contact your system administrator for the connecting code. Different systems have different codes.

To retrieve the new voicemail via the Phone interface:

- 1) Press the Voicemail softkey directly.
- 2) You may be prompted to enter the password which is needed to connect to your VoIP telephony system. It depends on your system.
- 3) Your voice mailbox is called and you are able to listen to your new and old messages.

**Note:**

Before retrieving the new voicemail, please make sure that the connecting code has been set on the phone.

## SMS

You can retrieve the SMS in the same way as Voicemail.

To retrieve the SMS via Phone interface:

- 1) Press MESSAGE button, scroll to Text Message, press Enter softkey.
- 2) Use the navigation softkey to highlight the options. You can read the message in the in the Inbox/Sentbox/Outbox/Draftbox.

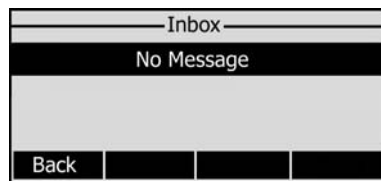

- 3) Press Read softkey to open and read the specific message.

To reply the SMS via Phone interface:

- 1) After retrieving the specific message, press Reply softkey, use the Ab3 softkey to change the Input Method.

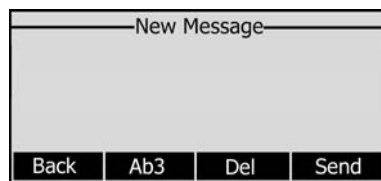

- 2) (Optional) If multiple lines are configured on your phone, select from which line messages are to be retrieved from the list using the navigation keys and Messages appear first to last in sent order.
- 3) Press Send softkey, you are required to choose an account which is used to send out the message and the number you want to send to.
- 4) Press Send softkey to send out the message, or Back softkey to return to the previous menu.

To edit a new message via the Phone interface:

- 1) Press MESSAGE button, scroll to Text Message, press Enter softkey.
- 2) Scroll to New Message, press Enter softkey.
- 3) Edit the new message, use the Ab3 softkey to change the Input Method.

- 4) (Optional) If multiple lines are configured on your phone, select from which line messages are to be retrieved from the list using the navigation keys and Messages appear first to last in sent order.
- 5) Press Send softkey to send out the message, or Back softkey to return to the previous menu.

To delete the message via the Phone interface:

- 1) After retrieving the specific message, press Delete softkey.
- 2) You are prompted to confirm the Delete, press Yes softkey to delete the message, press No softkey to return to previous menu.

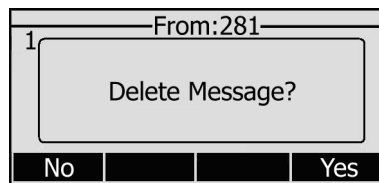

To edit the message via Web interface:

- 1) Choose Phone->Message.
- 2) Enter the account information, target phone number, message content.
- 3) Press Send button to send out the message, or Cancel button to cancel the operation.

**Note:**

You can not perform the messaging via Web interface except edit Message.

## Using the Advanced Phone Functions

### Account Setting

Please refer to the previous part "Configuration and Registration" for the basic Account setting information. The following table lists the instruction of the field about the advanced Account Setting.

Field Name	Description
<i>UDP Keep-alive Message</i>	Defines whether to active the phone UDP Keep-alive mechanism. The default is Enabled.
<i>UDP Keep-alive Interval</i>	This parameter specifies how often the phone will send a packet to the SIP server. Default is 30 seconds.
<i>Login Expire</i>	This parameter specifies the time frequency that phone refreshes its registration. The default interval is 3600 seconds.
<i>Local SIP Port</i>	Local SIP port. The default value is 5060.
<i>Local RTP Port</i>	Defines the local RTP port that the phone will listen and transmit. The default value is 11780.
<i>RPort</i>	The parameter allows you configuring the proxy to send responses back to a particular address and port. The default is disabled.
<i>SIP Session Timer</i>	This document defines an extension to the Session Initiation Protocol (SIP). This extension allows for a periodic refresh of SIP sessions through a re-INVITE or UPDATE request. The refresh allows both user agents and proxies to determine if the SIP session is still active.
<i>Subscribe Period</i>	This parameter could set the period of the subscription. The default value is 3600.
<i>DTMF Type</i>	Select the DTMF type.

You can only configure these settings via Web interface.

- 1) Choose Account.
- 2) Select the desired account.
- 3) Choose Advanced to do the relating settings.

You can consult your system administrator for more information.

## TLS

TLS(Transport Layer Security), an IETF standards track protocol(RFC 5246), was based on the earlier SSL specifications developed by Netscape Corporation.

Go to Account->Advanced, choose Transport option, in the pull-down menu, you can choose the TLS option, and then click the Confirm button to save the change.

The screenshot shows the Yealink web interface with the 'Account' tab selected. The 'Basic >>' section is expanded, displaying the following settings:

Field Name	Value	Port
Register Status	Registered	
Line Active	<input checked="" type="radio"/> On <input type="radio"/> Off	
Label	456	
Display Name	zz	
Register Name	456	
User Name	456	
Password	•••	
SIP Server	192.168.1.199	Port:5060
Enable Outbound Proxy Server	Disabled	
Outbound Proxy Server		Port:5060
Transport	UDP	
Backup Outbound Proxy Server	UDP	Port:5060
NAT Traversal	TLS	
STUN Server	217.10.79.21	Port:10000
Voice Mail		
Proxy Require		
Anonymous Call	Disabled	
Anonymous Call Rejection	Disabled	

**NOTE**

- Display Name**  
SIP service subscribers name which will be used for Caller ID display.
- Register Name**  
SIP service subscribers Authenticate ID used for authentication.
- User Name**  
User account information, provided by VoIP service provider.
- NAT Traversal**  
Defines the STUN server will be active or not.
- Proxy Require**  
A Special parameter just for Nortel server. If you login to Nortel server, the value should be: com.nortelnetworks.firewall
- Codecs**  
Choose the codecs you want to use.
- Advanced**  
The Advanced parameters for administrator.

## Network Setting

### PC Port Setting

Please refer to the previous part "Configuration and Registration" for the basic Network WAN setting information. The following table lists the instructions of the field about the Network PC Port Setting.

Field Name	Description
<i>As Bridge</i>	If you select the Bridge mode, then the two Fast Ethernet ports will be transparent.
<i>As Router</i>	If you select the Router mode, the SIP phone will work as a router
<i>IP address</i>	User could configure the PC port IP address.
<i>DHCP Server</i>	If you set the DHCP server on, the device connected to the PC

	port will get the IP address automatically between the start IP address and the end IP address. But if you select the bridge mode, the DHCP server can not work.
<i>Starting IP</i>	Indicate the range of the IP address
<i>End IP</i>	Indicate the range of the IP address

To configure PC Port settings via Phone interface:

- 1) Press Menu->Settings->Advanced Setting.
- 2) Enter the password required, scroll to Network option, press Enter softkey, select PC port, press Enter softkey.

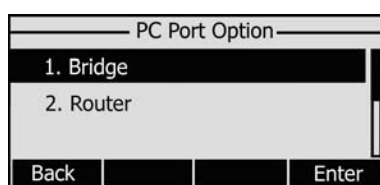

- 3) If you choose Bridge, it will return to the previous menu.
- 4) If you choose Router, you will be prompted to enter the IP Address, Subnet Mask, DHCP Server Disable/Enable.
- 5) Press Save softkey to save the changes, or Cancel softkey to return to the previous menu.

To configure PC Port settings via Web interface:

Choose Network-> PC Port to do the relating configuration, you can set the starting and end IP address only via Web interface. You can consult your system administrator for more information.

## VLAN Setting

VLAN is a group of hosts with a common set of requirements that communicate as if they were attached to the Broadcast domain, regardless of their physical location. The following table lists the instruction of the field about the VLAN Setting.

Field Name	Description
<i>QoS</i>	When the network capacity is insufficient, QoS could provide priority to users by setting the value.
<i>Local RTP Port</i>	Define the port for voice transmission.
<i>WebServer</i>	Users can choose the WebServer type: Disable, HTTP, HTTPS, or HTTPS & HTTP.

To configure VLAN settings via Phone interface:

- 1) Press Menu->Settings->Advanced Setting.
- 2) Enter the password required, scroll to Network option, press Enter softkey, select VLAN, press Enter softkey.



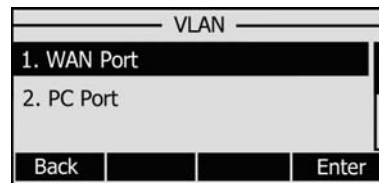

- 3) Choose WAN Port, press Enter softkey.

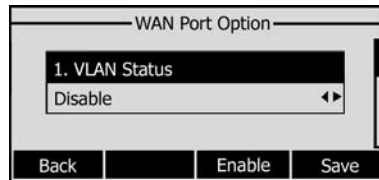

- 4) Set the VLAN Status, and input the VID Number, Priority.  
5) Press Save softkey to save the settings, or Back softkey to return to VLAN menu.  
6) Follow the same way to set the PC Port option.

To configure VLAN settings via Web interface:

Choose Network->Advanced to do the relating configuration. You can consult your system administrator for more information.

## HTTPS

This IP phone can support HTTPS (Hypertext Transfer Protocol over Secure Socket Layer). Adding SSL layer under HTTP, in short, it is a security version of HTTP. Users can set this transmission mode via web page.

To configure HTTPS settings via Web interface:

Go to Network->Advanced, choose WebServer option, in the pull-down menu of Type field, choose the transmission mode, and then click the Confirm button to save the changes.

**Yealink**  
EASY VOP

Status | Account | **Network** | Phone | Contacts | Upgrade | Security

Internet Port (WAN) | PC Port | **Advanced**

**VLAN**

WAN Port Active **Disabled** ▼  
 VID **0** (0-4094)  
 USRPRIORITY **0** ▼

PC Port Active **Disabled** ▼  
 VID **0** (0-4094)  
 USRPRIORITY **0** ▼

**Voice QoS**

Voice QoS **40** (0~63)  
 SIP QoS **40** (0~63)

**Local RTP Port**

MaxRTPPort **11800** (0~65535)  
 MinRTPPort **11780** (0~65535)

**WebServer**

Type **HTTP & HTTP** ▼

Confirm Cancel

**NOTE**

**VLAN**  
 VLAN is a group of hosts with a common set of requirements that communicate as if they were attached to the Broadcast domain, regardless of their physical location.

**QoS**  
 When the network capacity is insufficient, QoS could provide priority to users by setting the value.

**Local RTP Port**  
 Define the port for voice transmission.

**Note:**

For more details of the HTTPS, you can consult with your system administrator.

## Maintenance Tasks

### Administrator Mode

The phone allows two modes to configure the phone:

- User Mode
- Administrator Mode

Administrator mode grants unlimited access to the phone configuration on both Web and Phone interface. User Mode is not able to access the settings on the Phone interface such as: Accounts, Network, Reset to Factory, other phone settings.

### Administrator/User Password

Administrator mode grants unlimited access to the phone configuration on both web and phone user interface. The administrator/user password is used to access:

- Web interface along with user name.
- the advanced settings of the phone such as Network, Account, Reset to Factory Settings via the Phone interface.

The default administrator password is **admin**. Meanwhile the user name for Web interface access is **admin**.

To change the administrator password via Phone interface:

- 1) Press the softkeys Menu, scroll to Settings, press Enter softkey, use the navigation keys to highlight Advanced Settings.
- 2) You are prompted to enter the required password, the default one is **admin**.
- 3) Scroll to Set Admin Password, press Enter softkey.
- 4) You are prompted to enter the old and new password, Press Ab3 softkey to change the input method.

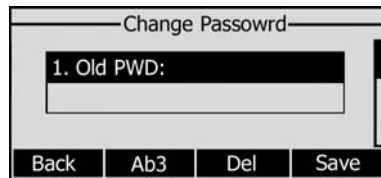

- 5) Press OK softkey to confirm the change, press Cancel softkey to return to previous menu.

To change the administrator password via Web interface:

Choose Security, enter the old, new password and Confirm Password, choose Confirm button to save the changes, or Cancel button to cancel the changes.

## Reboot

You should reboot the phone when you are challenged, e.g. after applying changes to the phone configuration.

To reboot via Web interface:

- 1) Choose Upgrade->Basic.
- 2) Click Reboot button.

### Note:

You can only reboot from Web interface. Please do not power off during reboot, or it will case the flash memory error.

## Reset to Factory

You should reset the phone only in this case: the phone configuration was changed and the phone is not functioning anymore. To maintain the configuration of the phone, you need your system administrator or service provider's advice.

To reset to factory via phone interface:

- 1) Press the softkeys Menu, scroll to Settings, press Enter softkey, use the navigation keys to highlight Advanced Settings.
- 2) You are prompted to enter the required password, the default one is **admin**.
- 3) Scroll to Reset to Factory, press Enter softkey.
- 4) You are prompted to confirm the change, press OK softkey to reset to factory settings, press Cancel softkey to return to previous menu.

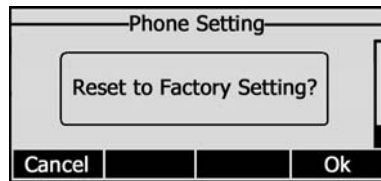

- 5) It will takes a few minutes to reset, please do not power off during resetting, or it will cause flash memory error.

To reset to factory under the idle status:

Press the OK button for 5 seconds when the phone is idle, the phone will enter the reset interface automatically.

To reset to factory via Web interface:

- 1) Choose Upgrade->Basic.
- 2) Click Reset button.

**Note:**

If you confirm all current setting changes including contact list, call history, account settings, etc will be lost, you need to export the configuration first if you still want to import the old configurations after reset. Or your phone must be configured a new manually unless mass provisioning is used!

To Export/Import the old configuration file via Web interface:

- 1) Choose Upgrade->Advanced, select Import/Export Configuration, choose Export button to export the file to your local computer.
- 2) Choose Upgrade->Advanced, select Import/Export Configuration, choose Browse button, select the specific configuration file in your local computer, choose Import button.
- 3) It will takes a few minutes to reset, please do not power off during resetting, or it will cause flash memory error.

## Firmware Update

The phone is delivered with pre-installed firmware which allows operating your phone flawlessly. If you require updating the phone's firmware please contact your system administrator. You can only update the firmware via Web interface.

To update the firmware manually via Web interface:

- 1) Choose Upgrade->Basic->Browse, select the firmware file in your local computer.
- 2) Click Upgrade button to update the new firmware.
- 3) Please do not power off during the updating.

To update the firmware automatically via Web interface:

- 1) Choose Upgrade->Advanced, configure the relating settings: Protocol, TFTP Server Address/Port, Check New Firmware, Period, ASE Key.
- 2) Choose Confirm button, the phone will check the server for a new firmware in a specific time, and it updates automatically if there is new firmware.

3) You can also update the firmware immediately by pressing Auto-provision button.

The parameters of the Auto-provision:

Parameter	Description
<i>Update Protocol</i>	The phone can be updated via TFTP, FTP or HTTP
<i>TFTP Server</i>	If you choose TFTP as protocol TFTP, you need to enter the TFTP server IP address and port
<i>Check new config</i>	You can specific the period that your phone checks the new firmware from the server: Power on, Scheduling, Disable and both.
<i>Scheduling</i>	You can specific the period in days which the phone checks and updates the new firmware, the range is 1-30 days

**Note:**

1. Any power interruption during the following process will most likely lead to a flash memory error. As a result the system cannot boot up anymore. The procedure can be only conducted in Administrator Mode.
2. If the updating is failed, you can re-plug the power adaptor, and press the Speaker key for 3 seconds, the IP phone will enter the account configuration interface. Users can reconfigure the IP phone account information here, and then press the OK button to save the changes.

## Decryption

This IP phone can support y000000000000.cfg and mac.cfg files encryption and decryption for user authentication to realize security usage. If there are any encrypted y000000.cfg or mac.cfg files on the server, users can open the webpage of your IP phone. Go to Upgrade->Advanced, choose and fill in the Specified AES Key (for y000000000000.cfg, should be 16 bit) and Per-phone AES Key (for mac.cfg, should be 16 bit) option, then click the Confirm button to decryption the files and upgrade to the new version. Shown as below:

The screenshot shows the Yealink web interface with the 'Upgrade' tab selected. The 'Advanced' configuration page is displayed, featuring various settings for the phone. The 'Custom Option' field is set to '(128 ~ 254)'. The 'Custom Option Type' is set to 'String'. The 'URL' field is empty. The 'Account' field contains 'fdg\*'. The 'Password' field is empty. The 'Specified AES Key' field contains 'DFGDFG&45'. The 'Per-phone AES Key' field is empty. The 'PNP config' is set to 'Disabled'. The 'Check New Config' is set to 'Power on'. The 'Click here to Autoprovision Now' button is labeled 'Autoprovision'. The 'Export / Import Config' section includes a 'Browse...' button, 'Import', and 'Export' buttons. The 'Export System Log' section includes a 'Local' dropdown menu and an 'Export' button. At the bottom, there are 'Confirm' and 'Cancel' buttons.

**NOTE**

**Custom Option**  
The phone will first use the custom option if present or use Option 66,43 if the custom option is not present. If the DHCP server sends nothing, then the boot server address from URL which provided by ISP.

**AES Key**  
It is provided by ISP.

**Click here to Autoprovision Now**  
Click this button to auto provision immediately.

**Export/Import Config**  
Export the configuration files to backup the settings, and could import all the settings after reset.

**System Log**  
There have two methods to restore the syslog, syslog or local device.

**Note:**

You can ask your system administrator for the decrypt password.

## System Log Export

If there is any errors happened in your phone, you can export the system log and send to your system administrator for diagnosis.

To export the System Log:

Choose Upgrade->Advanced, select Export System Log, choose Export button to export the file to your local computer.

## Programmable Key Configuration

The phone has 3 account buttons which are able to set up to 16 functions per key. The following list shows the functions you can set on the programmable keys and provides a description for each function. The default configuration for each key is N/A which means the key hasn't been set for any functions.

- N/A
- Line
- Speed Dial
- Intercom

- Conference
- Forward
- Transfer
- Hold
- DND
- Redial
- Call Return
- Group Pickup
- Call Park
- Group Listening
- SMS
- Voicemail
- Custom

**Note:**

Quick access features like Intercom and Voicemail must first be configured on your PBX in order to work on your phone. See your system administrator for more information.

## Line

You can set these keys as line keys to active up to the three user accounts.

To assign the key as Line:

Choose Phone-> DSS Key ->Line Key, choose one of the link key you want to make the assignment, there is a pull-down menu in the Type field, choose Line from the list, press Confirm button to save the changes.

## Speed Dial

You can configure the key as a simplified speed dial key. This key function allows you to easily access your most dialed numbers.

To assign the key as Speed Dial:

- 1) Choose Phone-> DSS Key -> Line Key, choose one of the key you want to make the assignment, there is a pull-down menu in the Type field, choose Speed Dial from the list.
- 2) In the "Line" field, select a line for which to apply this key, in the "Number" field enter the extension number you want to perform Speed Dial.
- 3) Press Confirm button to save the changes.

## Intercom

You can configure the key for Intercom mode and is useful in an office environment as a quick access to connect to the operator or the secretary.

To assign the key as Intercom:

- 1) Choose Phone->DSS Key ->Line Key, choose one of the key you want to make the

assignment, there is a pull-down menu in the Type field, choose Intercom from the list.

- 2) In the "Line" field, select a line for which to apply this key, the default one is Auto which means it will match the account automatically. And enter the extension number you want to intercom.
- 3) Press Confirm button to save the changes.

**Note:**

Your VoIP PBX must support this feature. And make sure the intercom extension enables the Auto-answer function.

## Conference

You are allowed to configure the programmable key to be used as a conference key while remaining in the current call. This key allows a user on a call to conference another party at a pre-defined number while remaining in the conference.

To assign the key as Conference:

- 1) Choose Phone->DSS Key ->Line Key, choose one of the key you want to make the assignment, there is a pull-down menu in the Type field, choose KeyEvent from the list, then in the Mode field, click the pull-down menu and choose Conference.
- 2) Press Confirm button to save the changes.

## Forward

If the key is configured as Forward key, press this key under the idle status, the IP phone will turn to the Always Forward page, and you can set the Forward to number, then when there is any call to the extension number will be forwarded to the set number automatically.

To assign the key as Forward:

- 1) Choose Phone->DSS Key ->Line Key, choose one of the key you want to make the assignment, there is a pull-down menu in the Type field, choose KeyEvent from the list, then in the Mode field, open the pull-down menu and choose Forward from the list.
- 2) Enter the extension number you want to forward to in the Extension field.
- 3) Press Confirm button to save the changes.

## Transfer

You are able to configure the key as a transfer key to perform the Blind/Attended Transfer.

To assign the key as Transfer:

- 1) Choose Phone->DSS Key ->Line Key, choose one of the key you want to make the assignment, there is a pull-down menu in the Type field, choose KeyEvent from the list, then in the Mode field, open the pull-down menu and choose Transfer from the



list.

- 2) Press Confirm button to save the changes.

## **Hold**

The key can be configured as a hold key. You can use this key to hold and retrieve a call during the conversation.

To assign the key as Hold:

- 1) Choose Phone->DSS Key ->Line Key, choose one of the key you want to make the assignment, there is a pull-down menu in the Type field, choose KeyEvent from the list, then in the Mode field, open the pull-down menu and choose Hold from the list.
- 2) Press Confirm button to save the changes.

## **DND**

If the key is configured as DND key, you are allowed to active the DND function immediately when you press it. Press it again to deactivate DND mode.

To assign the key as DND:

- 1) Choose Phone->DSS Key ->Line Key, choose one of the key you want to make the assignment, there is a pull-down menu in the Type field, choose KeyEvent from the list, then in the Mode field, open the pull-down menu and choose DND from the list.
- 2) Press Confirm button to save the changes.

## **Redial**

If the key is configured as Redial key, press this key under the idle status, it will fetch the last dialed number, then you can choose a special line to call out by pressing the line keys.

To assign the key as Redial:

- 1) Choose Phone->DSS Key ->Line Key, choose one of the key you want to make the assignment, there is a pull-down menu in the Type field, choose KeyEvent from the list, then in the Mode field, open the pull-down menu and choose Redial from the list.
- 2) Press Confirm button to save the changes.

## **Call Return**

When the key is configured as Call Return key you are allowed to dial out the last phone call you received.

To assign the key as Call Return:

- 1) Choose Phone->DSS Key ->Line Key, choose one of the key you want to make the assignment, there is a pull-down menu in the Type field, choose KeyEvent from the list, then in the Mode field, open the pull-down menu and choose Call Return from

the list.

- 2) Press Confirm button to save the changes.

## Group Pickup

When you configure a Group Pickup key, you specify the extension that you want to monitor. Then, when the monitored extension receives a call, you press the key to pick up the call. If the monitored extension receives multiple incoming calls simultaneously, the IP Phone UI displays a list of incoming calls. You select a call from this list to start the conversation.

To assign the key as Group Pickup:

- 1) Choose Phone->DSS Key ->Line Key, choose one of the key you want to make the assignment, there is a pull-down menu in the Type field, choose KeyEvent from the list, then in the Mode field, open the pull-down menu and choose Group Pickup from the list.
- 2) In the "Line" field, select a line for which to apply this key, and enter the extension number you want to pickup.
- 3) Press Confirm button to save the changes.

## Call Park

Call Park is a feature that allows a person to put a call on hold at one telephone set and continue the conversation from any other telephone set.

The "call park" feature is activated by pressing a preprogrammed button or a special sequence of buttons. This transfers the current conversation to an unused extension number and immediately puts the conversation on hold. The telephone system will then display the extension number of the parked call so that the call can later be retrieved.

To assign the key as Call Park:

- 1) Choose Phone->DSS Key ->Line Key, choose one of the key you want to make the assignment, there is a pull-down menu in the Type field, choose KeyEvent from the list, then in the Mode field, open the pull-down menu and choose Call Park from the list.
- 2) In the "Line" field, select a line for which to apply this key, and enter the extension number you want to park.
- 3) Press Confirm button to save the changes.

## Group Listening

When the key is configured as Group Listening key, you are allowed to enable the Speakerphone and Handset/Headset mode at the same time. It is suitable for the group conversation which has more than one person at one side. You are able to speak and listen using handset/headset; meanwhile the others near by can speak and listen using speakerphone. You can get back to the previous mode by pressing the key again.

To assign the key as Group Listening:

- 1) Choose Phone->DSS Key ->Line Key, choose one of the key you want to make the assignment, there is a pull-down menu in the Type field, choose KeyEvent from the list, then in the Mode field, open the pull-down menu and choose Group Listening from the list.
- 2) Press Confirm button to save the changes.

## **SMS**

When the key is configured as SMS key you are allowed to access SMS quickly by pressing this key.

To assign the key as SMS:

- 1) Choose Phone->DSS Key ->Line Key, choose one of the key you want to make the assignment, there is a pull-down menu in the Type field, choose KeyEvent from the list, then in the Mode field, open the pull-down menu and choose SMS from the list.
- 2) Press Confirm button to save the changes.

## **Voicemail**

When the key is configured as Voicemail key you are allowed to access voicemail quickly by pressing this key.

To assign the key as Voicemail:

- 1) Choose Phone->DSS Key ->Line Key, choose one of the key you want to make the assignment, there is a pull-down menu in the Type field, choose KeyEvent from the list, then in the Mode field, open the pull-down menu and choose Voicemail from the list.
- 2) In the "Line" field, select a line for which to apply this key, and enter the extension number you want to set as the voice mail box.
- 3) Press Confirm button to save the changes.

## **Custom**

You are allowed to send out the desired DTMF number during the conversation. The number needs to be set in advance.

To assign the key as Custom:

- 1) Choose Phone->DSS Key ->Line Key, choose one of the key you want to make the assignment, there is a pull-down menu in the Type field, choose KeyEvent from the list, then in the Mode field, open the pull-down menu and choose Custom from the list.
- 2) In the "Extension" field, enter the specific number.
- 3) Press Confirm button to save the changes.

## Tone Settings

You can define the frequency and time period of all the following tones:

- Dial
- Ring Back
- Busy
- Congestion
- Call Waiting
- Dial Recall
- Record
- Info
- Stutter
- Message
- Auto Answer

To edit the tone filed via Web interface:

- 1) Choose Phone->Tones.
- 2) Enter the frequency and time period(in ms) as the following format:  
Frequency /Time Period (for example 400/200).
- 3) Press Confirm button to save the changes, Cancel to cancel the changes.

**Note:**

1. Please contact your system administrator for more information about the frequency and time period parameters. You can enter up to 8 groups for each tone.
2. If the frequency is set as 0, it means silence.

## Voice

To edit the Voice filed via Web interface:

- 1) Choose Phone->Voice.
- 2) Set the following parameters shown in the table.

Parameter	Description
<i>Echo canceller</i>	
<i>VAD</i>	Voice activity detection (VAD), also known as speech activity detection or speech detection, is a technique used in speech processing in which the presence or absence of human speech is detected.
<i>CNG</i>	A comfort noise generator (CNG) is a program used to generate background noise for voice communications during periods of silence that occur during the course of conversation.
<i>JITTER BUFFER</i>	It is a shared data area where voice packets can be collected, stored, and sent to the voice processor in evenly.
<i>Type</i>	To choose the type of JITTER BUFFER, daptive or Fixed.
<i>Delay</i>	To set the Min Delay, Max Delay and Normal Delay paremeter.

**Yealink**  
EASY VOP

Status | Account | Network | **Phone** | Contacts | Upgrade | Security

Preference | Features | DSS Key | **Voice** | Ring | Tones | Dial Plan | SMS

**Echo Cancellation**

Echo canceller: Enabled

VAD: Disabled

CNG: Enabled

**JITTER BUFFER**

Type:  Adaptive  Fixed

Min Delay: 0

Max Delay: 300

Normal Delay: 120

Confirm Cancel

**NOTE**

**VAD**  
Voice Activity Detection.

**CNG**  
Comfort Noise Generation.

**JITTER BUFFER**  
It is a shared data area where voice packets can be collected, stored, and sent to the voice processor in evenly.

3) Press Confirm button to save the changes, Cancel to cancel the changes.

## Ring

Users can group your contacts, and then set the ringing tone for each group. To edit the Ring option via Web interface:

1) Choose Phone->Ring.

**Yealink**  
EASY VOP

Status | Account | Network | **Phone** | Contacts | Upgrade | Security

Preference | Features | DSS Key | Voice | **Ring** | Tones | Dial Plan | SMS

1	Internal Ringer Text	
	Internal Ringer File	Ring1.wav
2	Internal Ringer Text	
	Internal Ringer File	Ring1.wav
3	Internal Ringer Text	
	Internal Ringer File	Ring1.wav
4	Internal Ringer Text	
	Internal Ringer File	Ring1.wav
5	Internal Ringer Text	
	Internal Ringer File	Ring1.wav
6	Internal Ringer Text	
	Internal Ringer File	Ring1.wav
7	Internal Ringer Text	
	Internal Ringer File	Ring1.wav
8	Internal Ringer Text	
	Internal Ringer File	Ring1.wav
9	Internal Ringer Text	
	Internal Ringer File	Ring1.wav
10	Internal Ringer Text	
	Internal Ringer File	Ring1.wav

Confirm Cancel

**NOTE**

2) Internal Ringer Text: To set group name. For example, family.

3) Internal Ringer File: To choose a special ring tone for the group.

4) Click the Confirm button to save the changes.

# Trouble Shooting

## **I can not register to the server?**

- 1) Check the IP address. If you set your WAN port in DHCP mode, please make sure that your DHCP server is on.
- 2) Check your gateway.
- 3) Check your DNS server.
- 4) Make sure your account information is the same as you have got from your ISP.
- 5) Check whether the SIP server is on.
- 6) Check the SIP register port, the default value is 5060.

## **I can't get the IP address?**

- 1) Make sure you have plugged the Ethernet cable into the WAN port.
- 2) Make sure that the DHCP server is on, and there are available IP addresses in the server.
- 3) Try to set your WAN port to static IP client mode.

## **During a call, I can not hear any voice?**

- 1) Make sure your handset is tightly connected with the phone.
- 2) Check whether you have muted the conversation or not.
- 3) Consult the outbound server details with your ISP.

## **Have DTMF problem?**

- 1) Check which kind of DTMF you are using, and whether it is compatible with the server.
- 2) Consult the payload value with your ISP.

## **How to change the time?**

Select the time zone or enter the time information manually on the webpage or the phone.

## **How to answer the incoming calls during a call?**

If a call comes in when you are in a conversation, press the Up/Down navigation keys to enter the incoming call interface, then press the Answer softkey to answer it.

## **How to refuse incoming calls during a call?**

You can turn off the function of call waiting, and then our phone will refuse all the incoming calls when you are in a conversation.

**How to send SMS?**

You could edit the SMS in the Menu-> Messages->Text Messages.

**Note:**

Make sure that the SIP server you have registered supports SMS function.

**How to update the firmware?**

- 1) Enter the webpage of your phone, go to Upgrade, then you can find the option" Select and Upgrade Firmware" at the bottom of the page.
- 2) Select the file to update, then click the Upgrade button.

**Note:**

Make sure the firmware you choose is provided by your service provider, or the device will probably crash after the update.

**How to auto provision?**

Consult the auto provision server address with your ISP.

The manual is only for reference, please take the object as the standard.  
We reserve the right to improve or change the product and the user guide without notice.

V42.0