

PGT-09-S

HIPERFACE[®]
DSL

Programming Tool and Analyzer

E



Table of Contents

1	Scope	4
1.1	Related Documents.....	4
2	Requirements	5
2.1	Network (LAN / WAN)	5
2.2	PC (client host).....	7
2.2.1	Microsoft Windows® with Internet Explorer 7	7
2.2.2	Microsoft Windows® with Internet Explorer 6	10
2.3	Accessory	16
3	Installation	17
3.1	Power Supply	17
3.2	Ethernet connection	17
3.3	DSL connection.....	18
3.4	TRIGGER connection.....	19
3.5	Setup	20
3.5.1	Master Mode Setup	20
3.5.2	Slave Mode Setup	21
3.5.3	Analyzer Mode Setup	22
4	Getting Started	23
4.1	Starting the PGT-09-S.....	23
4.2	User-interface Basics	24
4.3	Configuration - Login	25
4.3.1	Language Choice	25
4.3.2	Operating Mode	26
4.3.3	Access Profile	26
4.4	Page Layout.....	28

PGT-09-S®

4.5	Sequencer.....	30
5	Master Mode	33
5.1	Status.....	33
5.2	Tabs.....	35
5.2.1	Master Registers	35
5.2.2	Remote Registers	36
5.2.3	Encoder Resources.....	38
6	Slave Mode	40
6.1	Status.....	41
6.2	Tabs.....	41
6.2.1	Encoder Resources.....	41
6.2.2	Encoder Emulation.....	41
6.2.3	Faulty DSL H-FRAME	43
7	Analyzer Mode.....	49
7.1	Status.....	49
7.2	Tabs.....	49
7.2.1	Configuration.....	49
7.2.2	Data Acquisition	54
7.3	Analyzer Data Formats.....	59
7.3.1	H-Frame Mode	59
7.3.2	Position Mode	60
7.3.3	Message Mode.....	60
7.3.4	Events.....	61
7.4	Protocol Signal Bits	62
8	Revision history	63

1 Scope

This manual provides the user with basic guidelines for properly using the PGT-09-S tool (SICK order no 1 037 530).

The PGT-09-S is a versatile engineering and diagnostic tool for use with motor-feedback systems based on the communication interface HIPERFACE DSL[®] by SICK.

1.1 Related Documents

Technical data and order information on the PGT-09-S can be found in the data sheet (SICK order no 8 013 606).

For further, general information on the protocol HIPERFACE DSL[®] please refer to the "User Manual HIPERFACE DSL[®]" (SICK order no 8 013 607).

2 Requirements

2.1 Network (LAN / WAN)

The PGT-09-S must be connected to an Ethernet network (TCP / IP based) and is integrated as a node (server host) into a LAN or WAN.

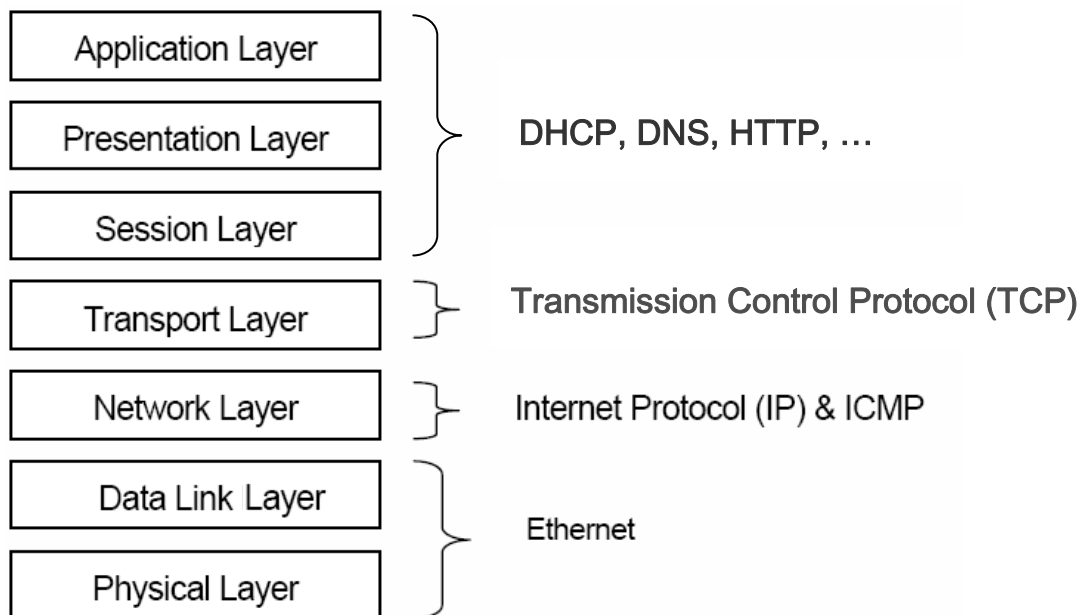

The support of a DHCP and DNS server is mandatory for automatically configuring the IP address of the PGT-09-S device and for registering its host name into the specific namespace of the network. This way a user can easily access the device by its name.

Please contact the appropriate network administrator to check the availability of DHCP and DNS services in your network.

Please also make sure that network security restrictions (e.g. firewalls) do not inhibit access to the PGT-09-S device.

Optionally a UDP connection (port 8001, limited broadcast protocol) is also supported for finding an active PGT-09-S device connected to the network.

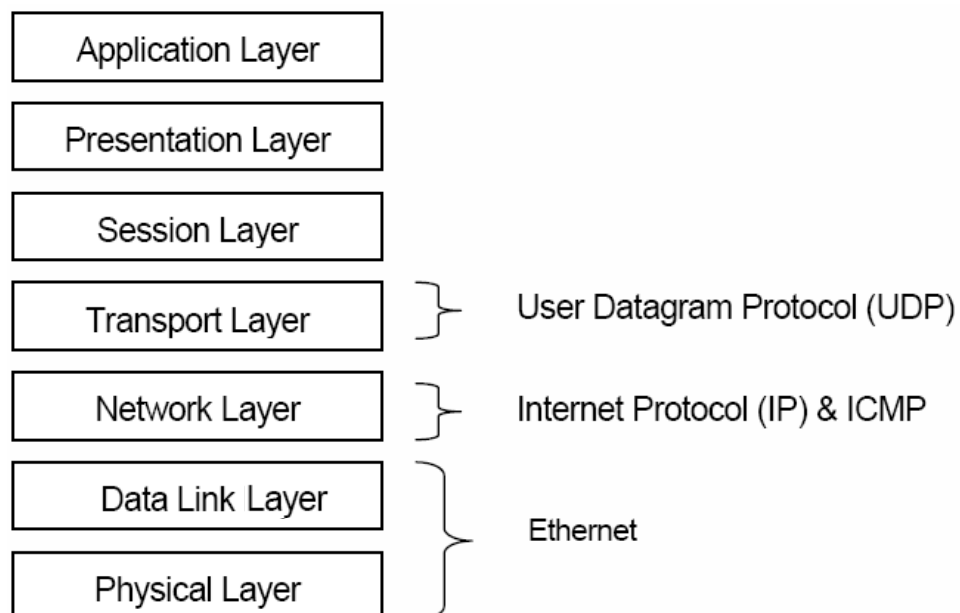

This mechanism reliably works even if the IP address of the device is unknown or the device is not reachable by an ordinary TCP connection, e.g. if it is configured for a different subnet.

This scanner utility application is supplied on the CD shipped with the PGT-09-S device.

PGT-09-S®

2.2 PC (client host)

The PGT-09-S offers access through a web browser application running on a client host connected to the same network (using a common subnet mask).

In general two important settings in the employed web browser are required:

- Change the web browser configuration so that “pop-up windows” from the PGT-09-S device are accepted and shown.
- Configure the temporary files handling so that cache is not used in order to allow the web browser to always ask for the most recent page version.

Specific instructions for these settings are given for example systems.

2.2.1 Microsoft Windows® with Internet Explorer 7

For allowing “pop-up windows” please follow these steps:

- Open Internet Explorer 7.
- Click on the “Tools” menu entry.
- Click on “Pop-up Blocker”.
- Click on “Pop-up Blocker Settings”.



- The “Pop-up Blocker Settings” window will open.

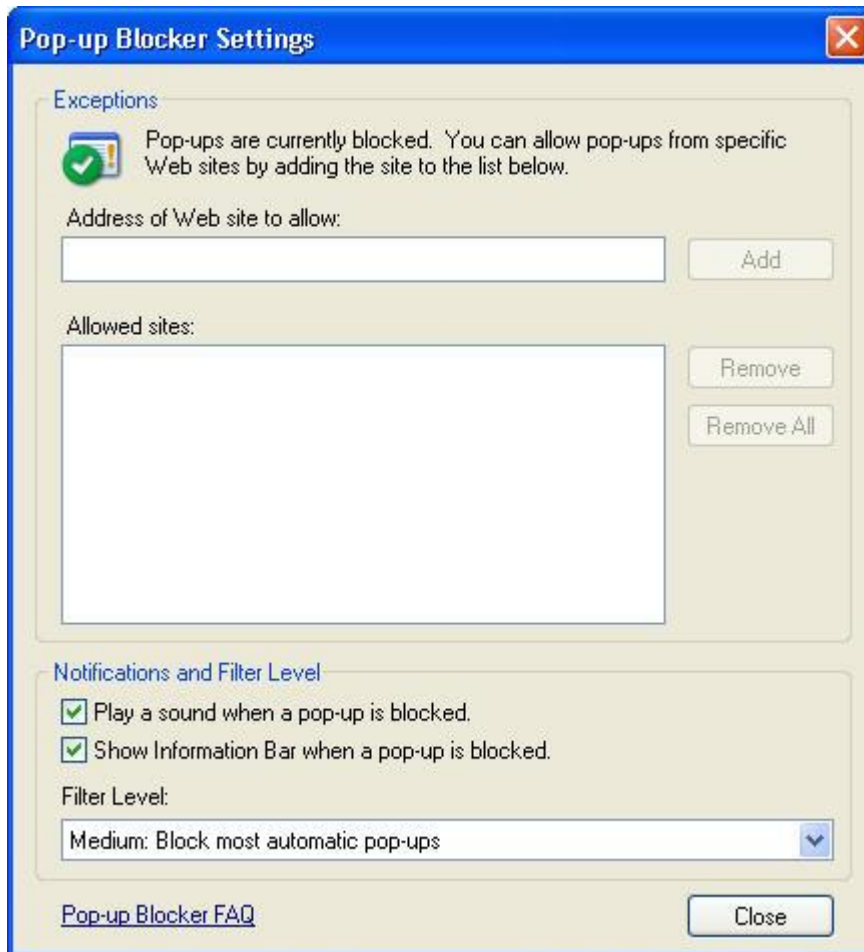

- Add the IP address or host name of the PGT-09-S device to the list of allowed sites.

To configure correct cache handling follow these steps:

- Open Internet Explorer 7.
- Click on the “Tools” menu entry.
- Click on the “Internet Options” entry.
- The “Internet Options” window will open.

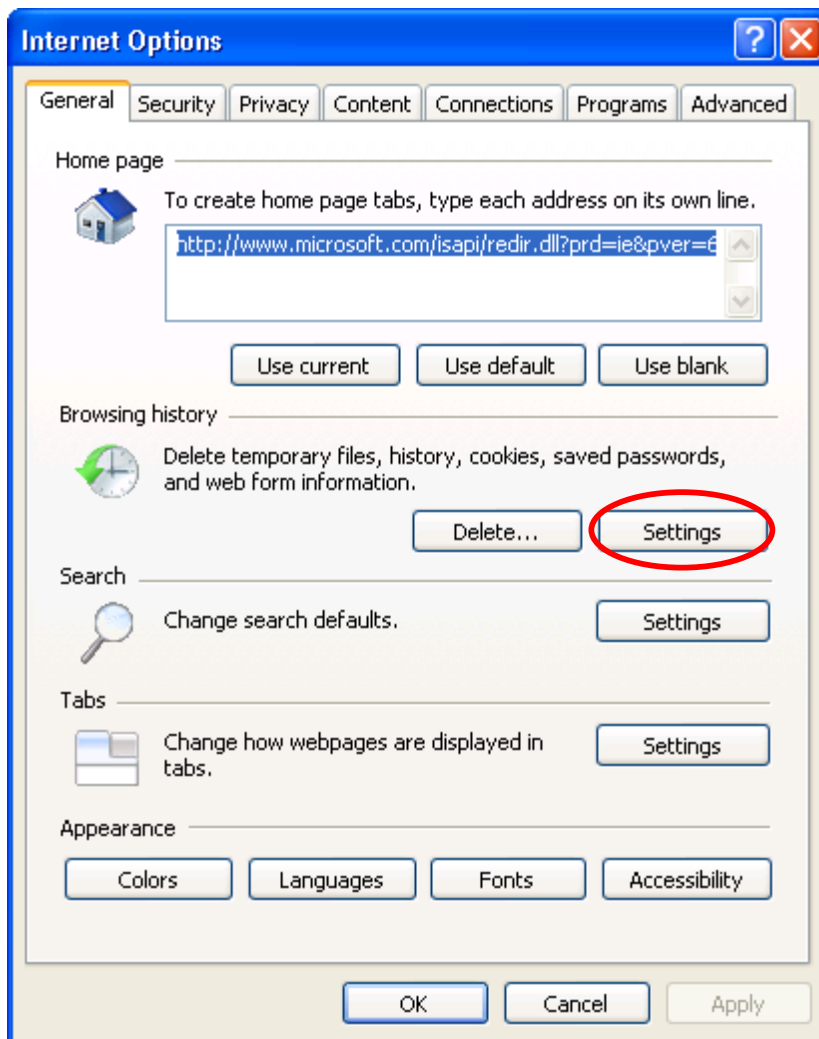

- Under “Browsing history” click “Settings”. The “Temporary Internet Files and History Settings” window will open.

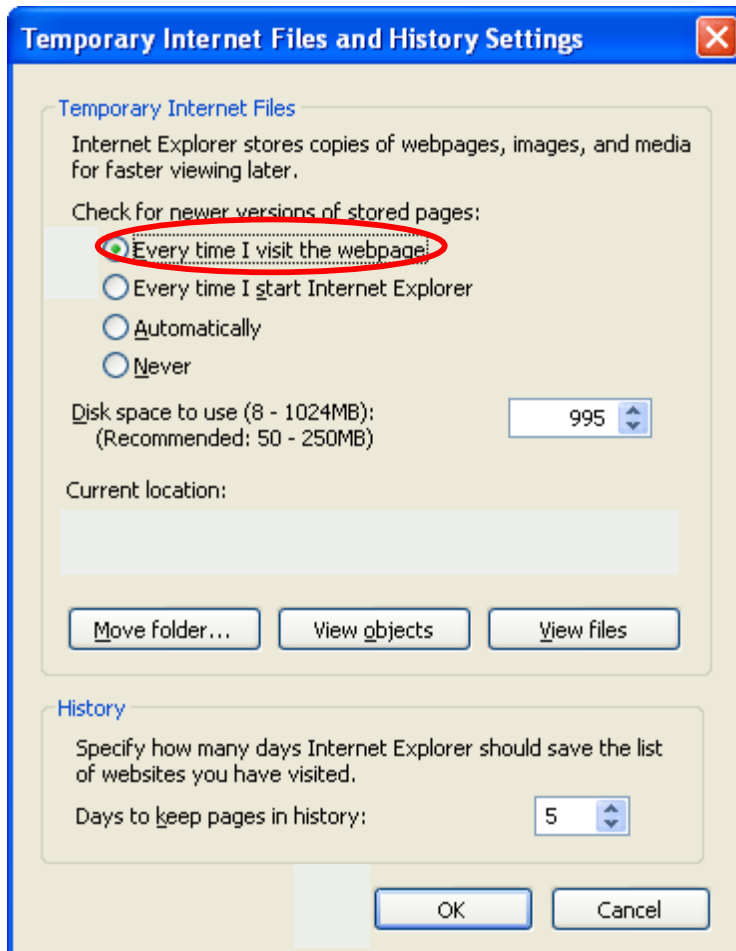

- Check the button “Every time I visit the webpage” for “Check for newer versions of stored pages”

2.2.2 Microsoft Windows® with Internet Explorer 6

For allowing “pop-up windows” please follow these steps:

- Open Internet Explorer 6.
- Click on the “Tools” menu entry.
- Click on the “Internet Options” entry.
- The “Internet Options” window will open.

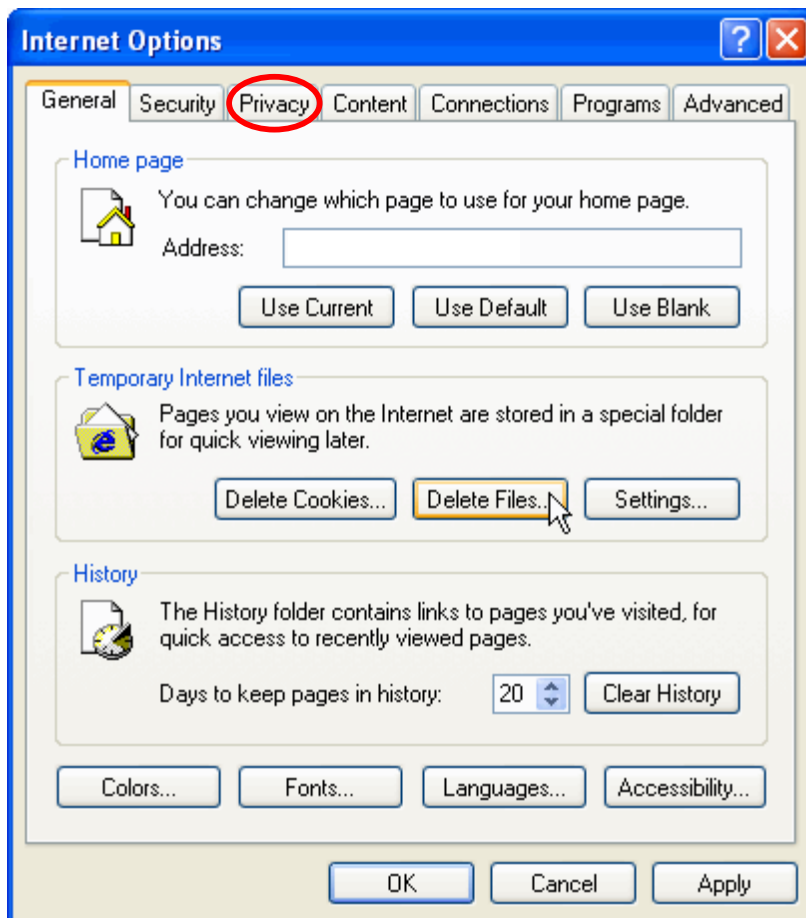

- Click on the “Privacy” tab.

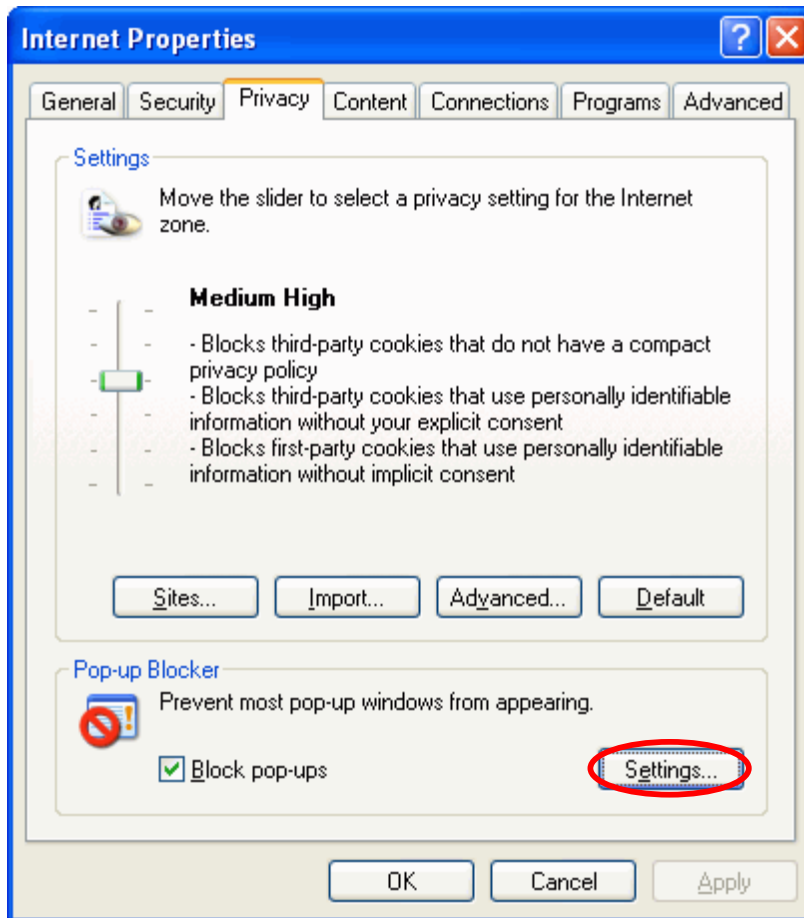

- Click “Settings” under “Pop-up Blocker”. The “Pop-up Blocker Settings” window will open.

PGT-09-S®



- Add the IP address or host name of the PGT-09-S device to the list of allowed sites.

To configure correct cache handling follow these steps:

- Open Internet Explorer 6.
- Click on the “Tools” menu entry.
- Click on the “Internet Options” entry.
- The “Internet Options” window will open.

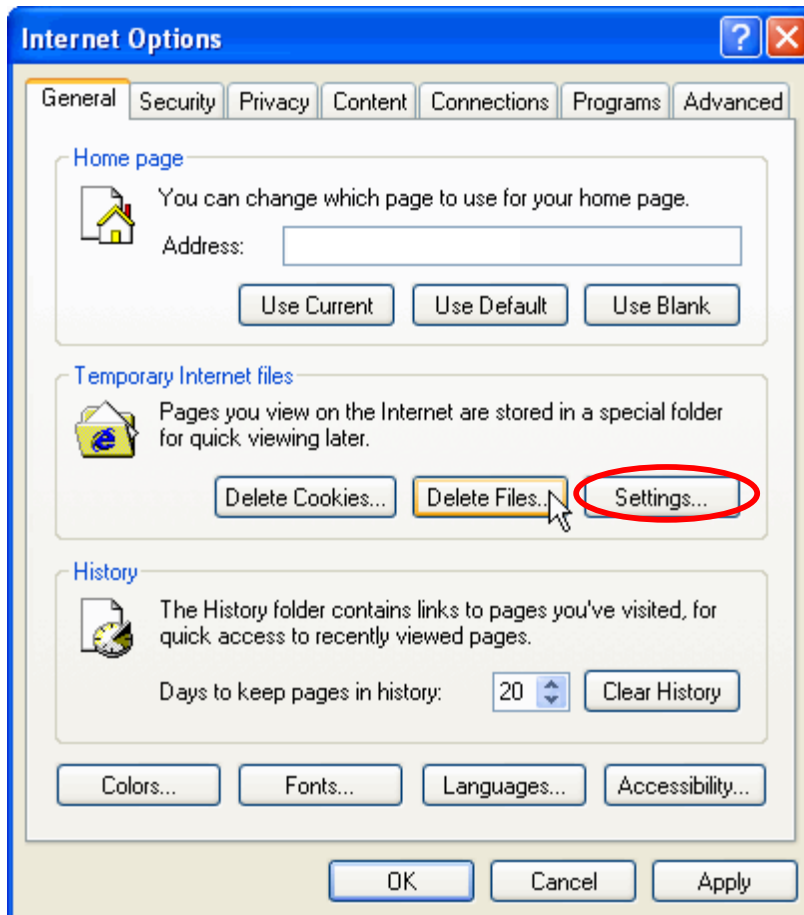

- Under “Temporary Internet files” click “Settings”. A “Settings” window will open.

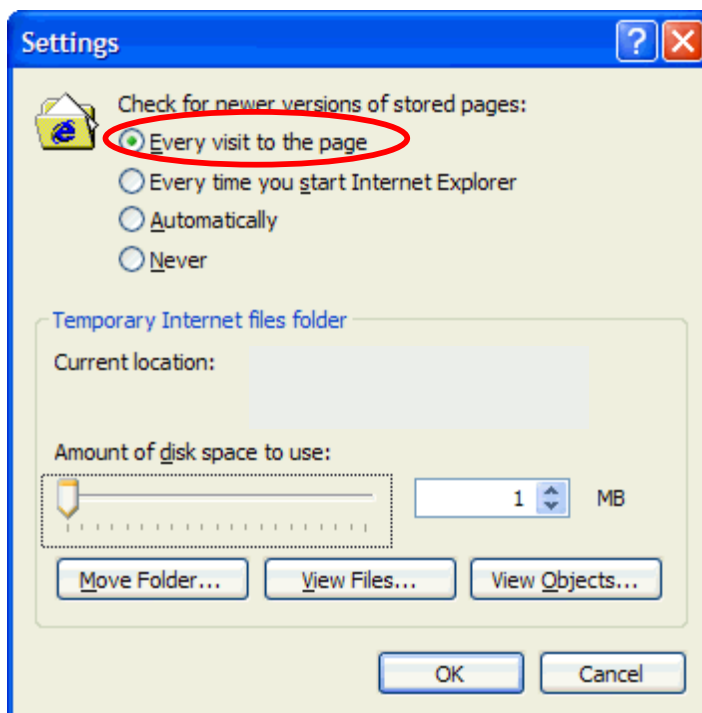

PGT-09-S®

- Check the button “Every time to the page” for “Check for newer versions of stored pages”
- Click “OK” in this window.
- Click “OK” in the “Internet Options” window.

2.3 Accessory

The required accessories to be used along with the PGT-09-S are:

- The power supply (12V DC) that is part of the delivery.
- A cabling set suitable for the HIPERFACE DSL[®] link (M12 connector)
- A suitable Ethernet cable (RJ45 connector)

The PGT-09-S datasheet should be referred for finding more details.

PGT-09-S®**3 Installation****3.1 Power Supply**

The PGT-09-S can be alternatively powered by:

- an external power-supply (12V DC) as the one that is part of the delivery.
- the HIPERFACE DSL® connection

The power-supply connector (jack type) is placed on the panel opposite to the HIPERFACE DSL® connectors.

Please check that the required polarity is matching with the following specification.

Supply voltage DC 12V ±10%



The PGT-09-S can supply a connected HIPERFACE DSL® encoder (DSL OUT) with power. It is not possible to supply a second PGT-09-S connected to the DSL IN or OUT ports.



Please note that the supply voltage of the PGT-09-S matches with the supply voltage range of a connected HIPERFACE DSL® encoder (usually 7-12 VDC). Supplying a PGT-09-S with a voltage higher than the rated encoder supply will lead to irreversible damage to a connected encoder.

The two specific pins of the HIPERFACE DSL® connectors (M12, pin 4 and 3, PWR+ and PWR- respectively) must be used to feed or draw power.

Connector	PIN	Signal	Description
DSL IN 	1	DSL+	Data HIPERFACE DSL
	2	DSL-	Data HIPERFACE DSL
	3	PWR-	Ground connection
	4	PWR+	12 VDC supply voltage
DSL OUT 	1	DSL+	Data HIPERFACE DSL
	2	DSL-	Data HIPERFACE DSL
	3	PWR-	Ground connection
	4	PWR+	12 VDC supply voltage

3.2 Ethernet connection

The PGT-09-S has an Ethernet port (RJ45) able to operate as 10BaseT or 100BaseTX mode, Full-Duplex; the operating mode is automatically selected at start-up.

PGT-09-S

The PGT-09-S must be connected to the Ethernet network through a port of an “Ethernet Switch” (a “Hub” device could also be used but is not recommended, as the communication performance might get worse).

3.3 DSL connection

The PGT-09-S provides user with two HIPERFACE DSL[®] connectors (M12), designated OUT and IN; in spite of the distinction and different connectors (male/female), their pins are equivalents (internal parallel connection).

These two separated connectors are fully exploited in the ANALYZER mode (see chapter 7), when the PGT-09-S is interconnected between a HIPERFACE DSL[®] Encoder and a servo drive implementing the HIPERFACE DSL[®] Encoder Interface (“DSL Master”).

Note that these connectors allow you to connect both 2-wire and 4-wire HIPERFACE DSL[®] lines. For a 2-wire connection, the pins PWR+ and DSL+, respectively PWR- and DSL- have to be short-cut externally to the PGT-09-S.

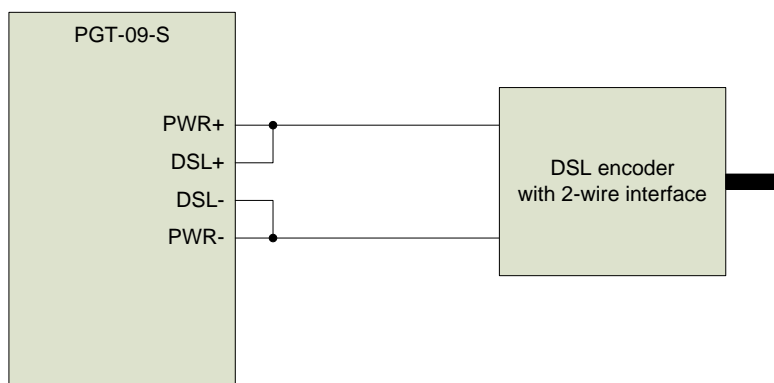

PGT-09-S®

3.4 TRIGGER connection

The PGT-09-S has a BNC connector suitable for supporting a trigger or “sync” function, depending on the operating mode of the tool. The PGT-09-S datasheet must be referred for finding full details on the electrical specification.

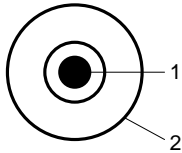

The interface can be used to feed a “sync” signal to the tool operating in Master mode (see chapter 5). Using this interface, the HIPERFACE DSL® encoder position acquisition is synchronized with the external “sync” signal. For further details on the acquisition synchronization, please refer to the HIPERFACE DSL® User Manual (SICK order no 8013607).

The TRIGGER interface can also be used to feed a trigger signal to the tool when operating in Analyzer mode (see chapter 7). In this case data logging is triggered by an external event.

3.5 Setup

The PGT-09-S is a dedicated tool for a HIPERFACE DSL[®] link. It is designed to function for different purposes (see chapters 5, 6, 7). Depending on the configuration the HIPERFACE DSL[®] connection has to be set up accordingly.

Refer to the diagrams below showing the individual setup requirements.

3.5.1 Master Mode Setup

The following figure shows the scenario where the HIPERFACE DSL[®] encoder is supplied from the PGT-09-S.

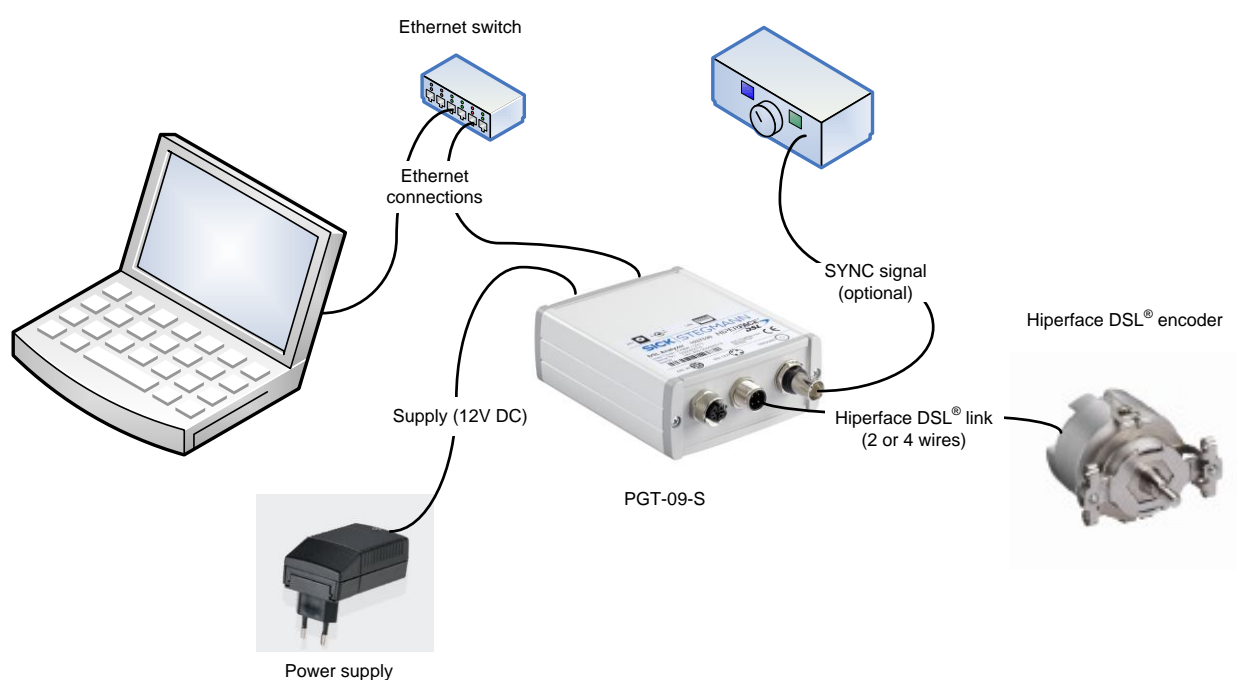

In the figure below the power supply for the encoder is used to also supply the PGT-09-S through the DSL connector IN.

PGT-09-S®

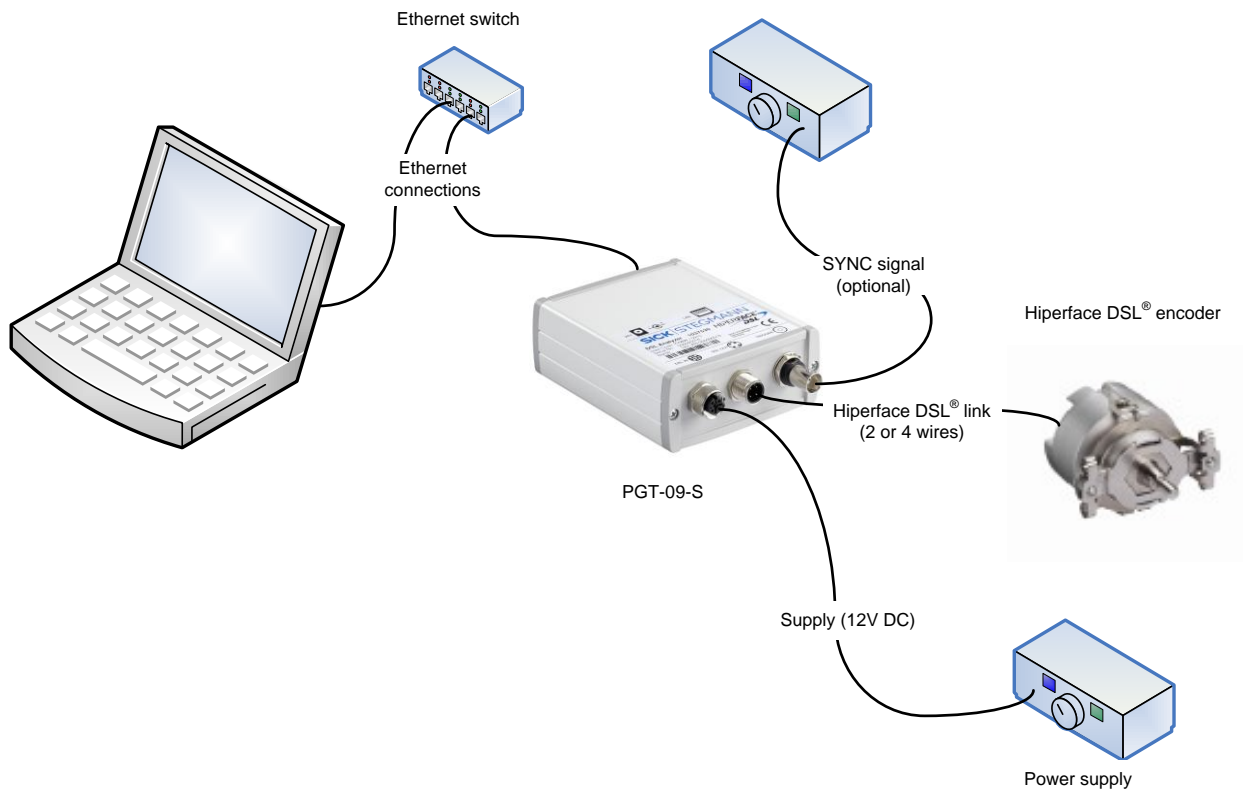

3.5.2 Slave Mode Setup

Below the setup for the SLAVE mode is shown. The PGT-09-S is powered through the DSL IN connection.

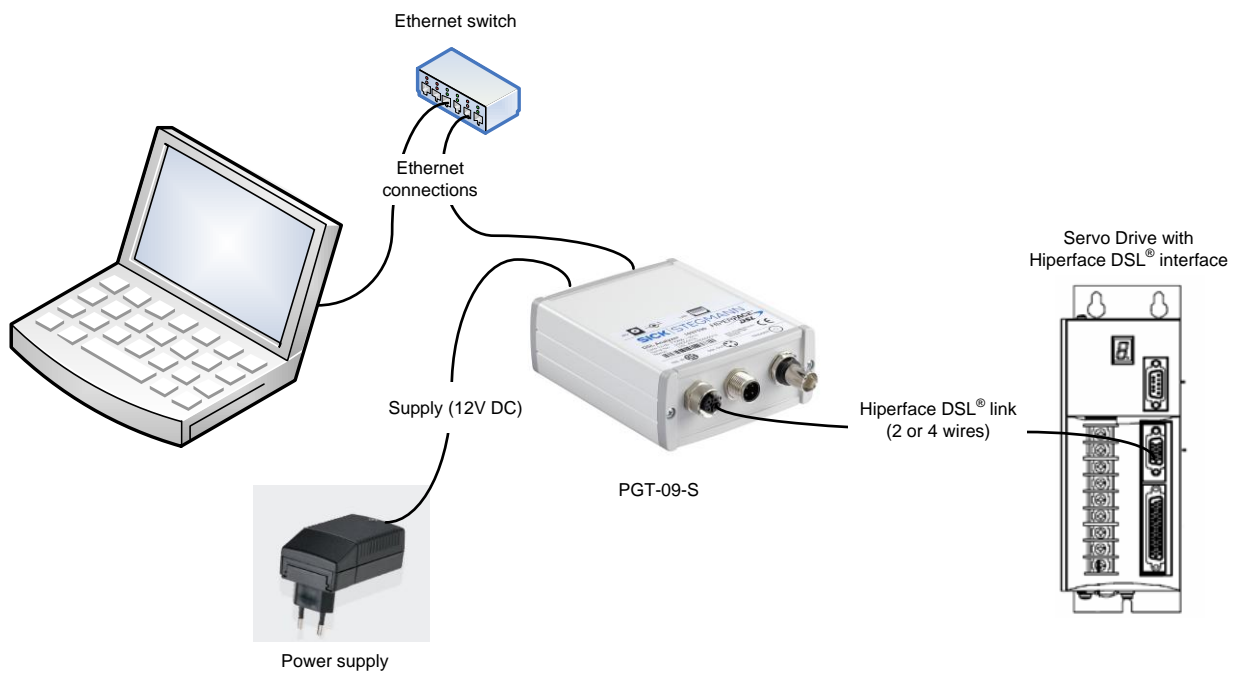

3.5.3 Analyzer Mode Setup

Below the setup for the ANALYZER mode is shown. The PGT-09-S is powered through the DSL IN connection.

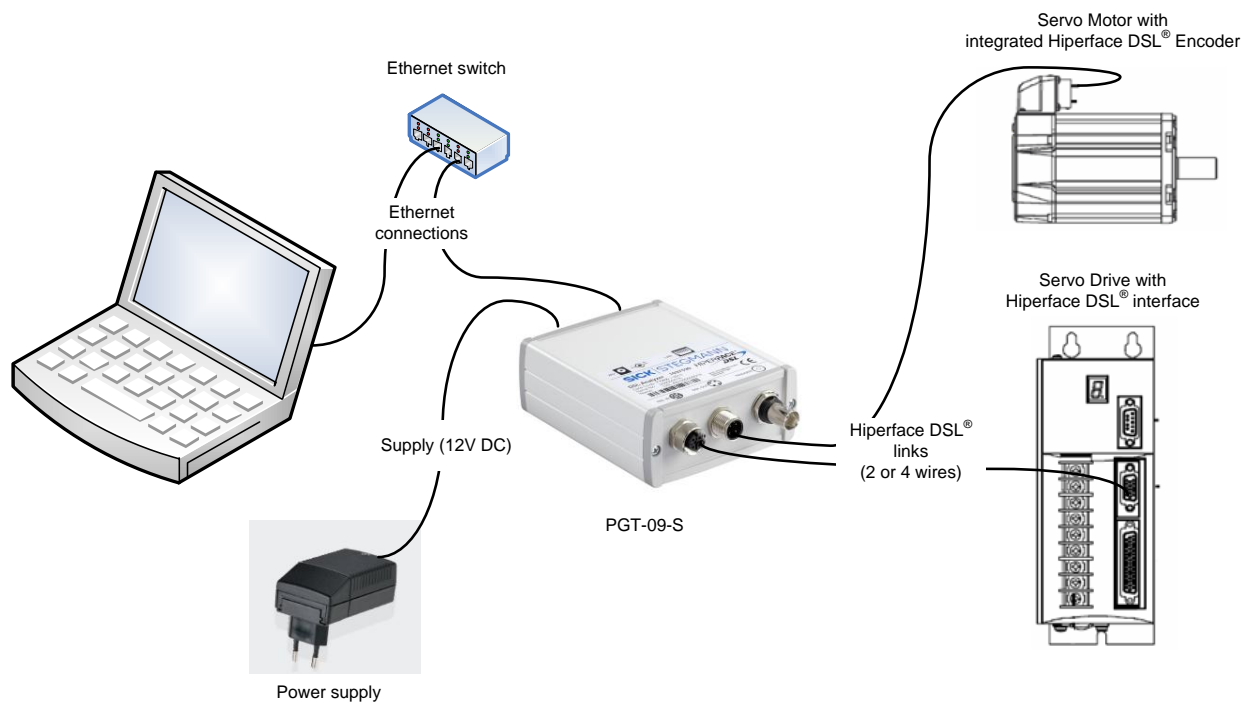

PGT-09-S®

4 Getting Started

4.1 Starting the PGT-09-S

The PGT-09-S is a versatile tool providing the user with different operating modes as listed below:

- MASTER mode as explained in chapter 5
- SLAVE mode as explained in chapter 6
- ANALYZER mode as explained in chapter 7

The MASTER mode provides the user with specific functionalities for interfacing a HIPERFACE DSL® Encoder. The tool is operating as a servo drive HIPERFACE DSL® Encoder Interface (DSL Master) and the user is able to access all DSL Master functions (e.g.: position and status readout) and the HIPERFACE DSL® Encoder resources for monitoring and programming purpose.

The SLAVE mode makes the tool a HIPERFACE DSL® Encoder emulator.

The ANALYZER mode provides the user with specific functionalities for a deep investigation on the HIPERFACE DSL® link for focusing on data transmission issues.

For the PGT-09-S are two different operating modes available.

- HDEB-mode, offers a windows based platform. The software can be downloaded free of charge on our homepage www.sick.com/software/PGT-09-S, in the Tutorial “HIPERFACE DSL encoder browser (HDEB)” the handling and the basics functions of the software are described. Target group for this operating mode are marketing and sales people. The tutorial as well as other information is available on the website: www.sick.com/hiperfacedsl
- Webserver-mode, offers access to all registers which are implemented in the specific motor feedback system. The functions and the handling is described ongoing in this document. Target group for this operating mode are technicians and software engineers.

The Webserver mode can be selected from the PGT-09-S home-page, which is shown as default in the web browser application window after accessing the PGT-09-S host. Access is made by entering the device DNS name

- <http://DSL-AN-xxxxxxxx/>

as indicated on the product label.



Please note that it might be necessary to use a “fully specified” host name including the network domain like

- <http://DSL-AN-xxxxxxxxx.yourdomain/>

Please consult your network administrator if you experience problems in this regard.

Alternatively, if the access by host name is not possible, the IP address of the PGT-09-S device can also be entered in the web browser address bar. The IP address can be found by using the scanning utility supplied on the CD shipped with the PGT-09-S device.

4.2 User-interface Basics

Before proceeding, it is worth focusing on the user-interface basics and the way to interact with the active objects located on the displayed pages by using a mouse and keyboard:

- “Clicking” or “Double-Clicking” actions refer to the standard use of the left-button of the mouse.
- “Pushing a Button” also refers to the use of the left-button of the mouse to activate a function associated with a push-button.
- “Cursor Keys” are accepted to browse either a list-view or a text-field to be edited.
- Standard edit-specific-keys are accepted.
- The “Enter-Key” is used both to start an edit session and to confirm the edited value.
- The “Escape-Key” is used to abort an editing session.

4.3 Configuration - Login

As soon as the Web browser successfully accesses the PGT-09-S the home page is shown as displayed in the following screenshot.

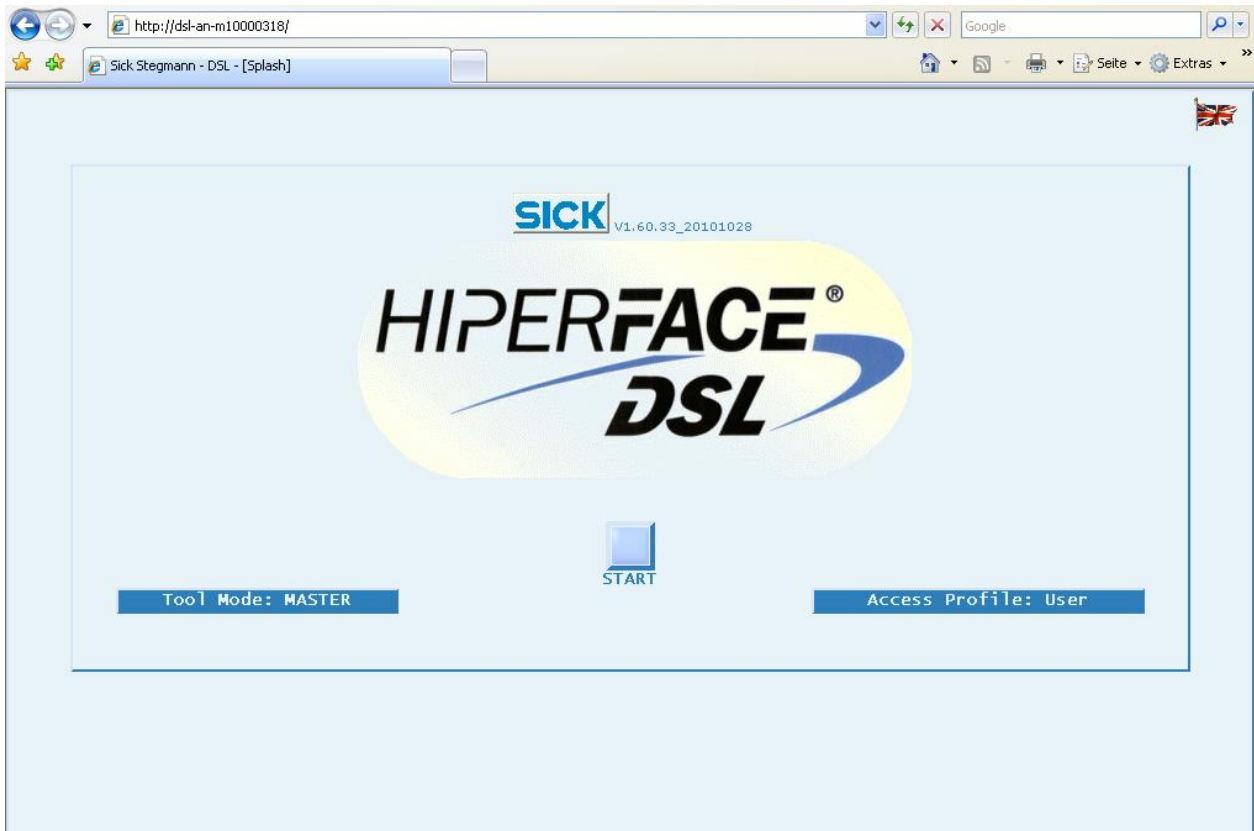

This startup page allows the user to select the language and the operating mode of the tool.

4.3.1 Language Choice

By clicking on the flag icon placed near the top-right corner, a scrolling list is shown in order to select an implemented language through the choice of national flags. A double-click on the selected flag determines the corresponding language setting.

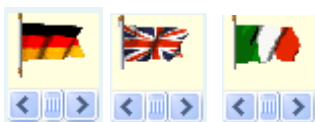

4.3.2 Operating Mode

The operating mode of the PGT-09-S determines the basic function of the tool in a DSL connection (Master, Slave, or Analyzer).

The operating mode is selectable through the push-button placed near the bottom-left corner. The active mode is shown as the button caption:

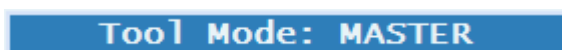

By pushing this button the list of operating modes is shown. Select and click a mode to make it active. The selected mode is kept after power-down.

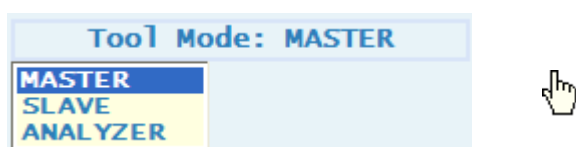

4.3.3 Access Profile

The access profile of the PGT-09-S determines which functions the user has access to.

The access profile is selectable through the push-button placed near the bottom-right corner. The active profile is shown as the button caption:



By pushing this button the list of operating modes is shown. Select and click a mode to make it active.

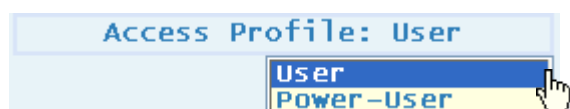

For any access profile except "User", a password is required. The password is entered after pushing the START button.



If so required, a window will request the password for the indicated access profile:

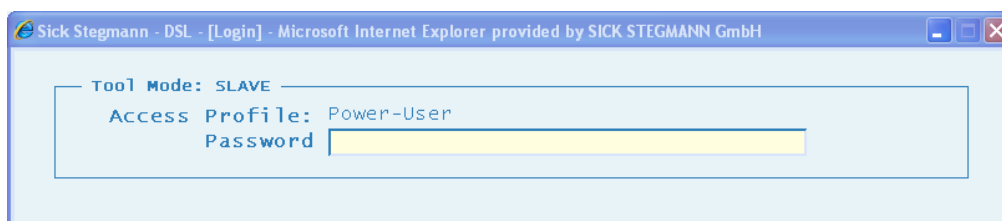

The passwords for the access profiles are listed in the following table:

PGT-09-S®

Access Profile	Password
User	(no password needed)
Power-User	2222

After password entry, the start screen of the requested operating mode is shown. The following screenshot shows the MASTER mode page as an example.

The screenshot displays the HIPEFACE DSL software interface in MASTER MODE. The top header includes the SICK logo, the HIPEFACE DSL logo, the device identifier 'DSL-AN-M10000318 [MASTER MODE]', and the date/time '05.11.10 12:12:57'. Below the header, there are three tabs: 'MASTER REGISTERS', 'REMOTE REGISTERS', and 'ENCODER RESOURCES'. The 'MASTER REGISTERS' tab is selected, showing a table of registers with the following data:

[Address]	[Name]	[ExtName]	[ResetValue]	[Access]
00	SYS_CTRL	System Control	00	W
01	SYNC_CTRL	Synchronization Control	01	RW
02	BITCNT_RB	Reserved	00	R
03	MASTER_QM	Quality Monitor	08	R
04 05	EVENT_HL	Event	0A00	RC
04	EVENT_H	Event.High	0A	RC
05	EVENT_L	Event.Low	00	RC
06 07	MASK_HL	Event Mask	0000	RW
06	MASK_H	Event Mask.High	00	RW

Below the table, there is a control panel with the following elements:

- A dropdown menu labeled 'Run till Stop'.
- A 'RUN' button.
- A 'Clear' button.
- A 'Save' button.
- A 'Load' button.
- A 'DSL Reset' button.
- A 'DSL Status' display showing the value '1003'.

The status bar at the bottom of the window shows 'User' and 'DSL'.

4.4 Page Layout

The page layout is common to all operating modes. The layout contains three areas:

- Header
- Main Windows
- Status Bar

The header integrates different information (logos, timestamp, tool name, mode) along with some push buttons, as shown below:



Please note that the name of the tool (DSL-AN-11111111) and the current selected mode (MASTER) are located inside the central bar as a big title.

Two buttons are located on the right-hand side:



for showing a quick guide.



for saving the current workspace and returning to the splash page.

The main window is reserved to the actual workspace. It is restored on startup if previously saved. At the top of the workspace are horizontally aligned tabs. Each is related to a specific function and can be pushed to activate (and show) or deactivate (and hide) the function itself.

For most functions the workspace is filled by the following objects:

- A list-view at the top, to be used as an “item pool” (e.g.: registers or resources).

[Address]	[Name]	[ExtName]	[ResetValue]	[Access]
17	VEL0	Velocity.Byte0	00	R
18	SUMMARY	Status Summary	00	R
19 1A 1B 1C 1D	VPOS	Absolute Position	0000000000	R
19	VPOS4	Absolute Position.Byte4	00	R
1A	VPOS3	Incremental Position.Byte3	00	R
1B	VPOS2	Incremental Position.Byte2	00	R
1C	VPOS1	Incremental Position.Byte1	00	R
1D	VPOS0	Incremental Position.Byte0	00	R
1E 1F	VPOS_CRC	VERT POS CRC	0000	R

- A list-view (“sequencer”) for acting on the items selected from the previous list-view .

[#]	[Op]	[Address]	[Name]	[HexValue]	[BitField]
1	R	04 05	EVENT_HL	08 00	00001000
	R	10 11 12 13 14	IPOS	FF FF FF FF FF	11111111
3	R	19 1A 1B 1C 1D	VPOS	00 00 00 00 03	00000000
4	R	1E 1F	VPOS_CRC	39 98	00111001
5	R	15 16 17	VEL	00 00 01	00000000
6	R	18	SUMMARY	80	10000000
7	R	0D 0E 0F	ENC_ID	00 01 53	00000000
8	C	04 05	EVENT_HL	00 00	00000000

PGT-09-S®

- A control panel with some push buttons to be used for activating specific functions.



The referred list-views can be browsed by using cursor keys. A row selection is done by clicking on a row. It will appear highlighted (upper and lower borders orange-colored, text characters red-colored). This is demonstrated in the screenshot below:

[Address]	[Name]	[ExtName]	[ResetValue]	[Access]
17	VEL0	Velocity.Byte0	00	R
18	SUMMARY	Status Summary	00	R
19 1A 1B 1C 1D	VPOS	Absolute Position	0000000000	R
19	VPOS4	Absolute Position.Byte4	00	R
1A	VPOS3	Incremental Position.Byte3	00	R
1B	VPOS2	Incremental Position.Byte2	00	R
1C	VPOS1	Incremental Position.Byte1	00	R
1D	VPOS0	Incremental Position.Byte0	00	R
1E 1F	VPOS_CRC	VERT POS_CRC	0000	R

In order to execute a Read, Write or Clear access to any register or resource, it must first be inserted into the sequencer relevant to the access execution according to the following procedure:

1. Select a register from the item pool
2. Hit the key (case insensitive) corresponding to the permitted access (“R”, “W”, “C”).



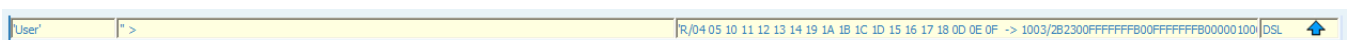

Please refer to the chapter Sequencer (4.5) to learn how to handle items after insertion into the list-view .

The “Status Bar” is reserved to status information, as shown hereafter:



As a common feature to all operating modes the “Status Bar” is mainly used for displaying dynamic events along with the identity logged on to the device.

On the right-hand side an arrow icon shows the HIPERFACE DSL® link status:

-  DSL link up
-  DSL link up, but Parameter Channel down
-  DSL link, maybe, down
-  DSL link down

Two text-fields are located in the middle of the “Status Bar”. The one on the left serves for displaying a message relevant to the running action whereas the one on the right serves for

PGT-09-S

monitoring the message strings exchanged between the user interface (the client host) and the PGT-09-S (the server host).

4.5 Sequencer

The “Sequencer” can be defined as a list of operations (item accesses) to be executed, sequentially or randomly. It is associated with a list-view of items to be accessed for reading, writing or clearing.

As an example some list-views of items to be accessed are shown hereafter:

MASTER Mode, Master Register access:

[#]	[Op]	[Address]	[Name]	[HexValue]	[BitField]
1	R	04 05	EVENT_HL	08 00	00001000
2	R	10 11 12 13 14	IPOS	00 00 00 00 0c	00000000
3	R	19 1A 1B 1C 1D	VPOS	00 00 00 00 03	00000000
4	R	1E 1F	VPOS_CRC	39 98	00111001
5	R	15 16 17	VEL	00 00 01	00000000
6	R	18	SUMMARY	80	10000000
7	R	0D 0E 0F	ENC_ID	00 01 53	00000000
8	C	04 05	EVENT_HL	00 00	00000000
9	W	20 21 22 23 24 25 26 27	PC_BUFFER	00 11 22 33 44 55 66 77	00000000
10	W	00	SYS_CTRL	00	00000000
11	W	3F	DUMMY	AA	10101010

MASTER Mode, Remote Registers access:



[#]	[Op]	[Address]	[Name]	[HexValue]	[BitField]
1	R	40	ENC_ST0	00	00000000
2	R	41	ENC_ST1	00	00000000
3	R	42	ENC_ST2	00	00000000
4	R	43	ENC_ST3	00	00000000
5	R	44	ENC_ST4	01	00000001
6	R	45	ENC_ST5	00	00000000
7	R	46	ENC_ST6	00	00000000
8	R	47	ENC_ST7	A1	10100001
9	C	40	ENC_ST0	00	00000000
10	W	7E	MAIL	01	00000001

MASTER Mode, Encoder Resources access:

[#]	[Op]	[Name]	[Offset]	[HexValue]	[BitField]	[RAE]
1	R	Encoder_Type		00 02	00000000	
2	R	Range		00 00 10 00	00000000	
3	R	Resolution		00 10 00 00	00000000	
4	R	Type_Code_Name	0000	53 4B 4D 33 36 2D 44 46	01010011	
5	R	EEPROM_Size		08 00	00001000	
6	R	Temperature		01 7F	00000001	
7	R	LED_Current		00 62	00000000	
	R	Read_Counter		00 00 00 00	00000000	
9	W	Increment_Counter				
10	W	Set_Position		00 00 00 00 00 00 00 00	00000000	
11	W	Reset				
12	W	Create/Delete_File	0140	???		

PGT-09-S®

A set of specific commands associated with keyboard commands (case insensitive) are available to handle the execution list content. These commands only ever apply to a selected row:

- “X” Execute specific access operation on the selected item.
- “D” Disable execution of selected item.
- “E” Re-enable execution of selected item.
- “P” Set a breakpoint at the selected item (flagged by ).
- “Home” Define the first item of an execution sequence (flagged by ).
- “End” Define the last item of an execution sequence (flagged by ).
- “Del” Remove selected item from execution list.

These keyboard commands are displayed when pushing the header “Quick Guide” button.

Note that “X” and “Del” are only executed if the “Sequencer” is stopped (please refer to the following control panel description).





The execution list can also be handled by using push buttons of the control panel placed beside the execution list-view:

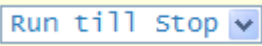

Please note that the execution sequence is defined as long as the first and the last item are defined, see below. First and last items can be redefined even while the execution is running.

[#]	[Op]	[Address]	[Name]	[HexValue]	[BitField]
<<	R	04 05	EVENT_HL	08 00	00001000 ▾
2	R	10 11 12 13 14	IPOS	00 00 00 00 0A	00000000 ▾
>>	R	19 1A 1B 1C 1D	VPOS	00 00 00 00 01	00000000 ▾
4	R	1E 1F	VPOS_CRC	39 98	00111001 ▾

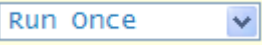
The mode of the execution sequence can be set by using the selector at the top of the control panel:

-  allows executing continuous access in a loop from first to last defined item.
- The  push button starts the execution loop.
- The  push button breaks the execution loop.
-  will cause a single loop of access once the  push button is hit.

PGT-09-S

- The **GO.ON** push button is automatically shown after a “P” command (set breakpoint). Use it to continue the execution loop after the breakpoint.

The control panel includes further push buttons for saving, loading, and clearing the execution list.

Please note that these operations are independent from the automatic save/load operations associated with the exit push button on the header.

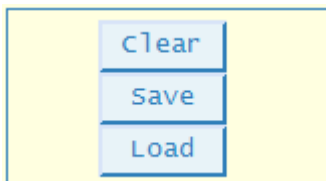

Please note that the save operation uses one storage slot so that the last stored execution list will be overwritten.

Two more push buttons are placed on the control panel not strictly relevant to the execution list. They are used to either reinitialize the complete HIPERFACE DSL[®] link or the protocol channel handling messages exchange.

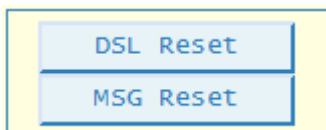

5 Master Mode

The Master mode provides the user with specific functionalities for interfacing a HIPERFACE DSL® Encoder. The PGT-09-S is operating as a HIPERFACE DSL® Encoder Interface (“DSL Master”) and the user is enabled to access the DSL Master registers (local and remote registers, e.g.: position and status readout) as well as all HIPERFACE DSL® Encoder resources for monitoring and parameterization purposes.

[Address]	[Name]	[ExtName]	[ResetValue]	[Access]
00	SYS_CTRL	System Control	00	W
01	SYNC_CTRL	Synchronization Control	01	RW
02	BITCNT_RB	Reserved	00	R
03	MASTER_QM	Quality Monitor	08	R
04 05	EVENT_HL	Event	0A00	RC
04	EVENT_H	Event.High	0A	RC
05	EVENT_L	Event.Low	00	RC
06 07	MASK_HL	Event Mask	0000	RW
06	MASK_H	Event Mask.High	00	RW

[#]	[Op]	[Address]	[Name]	[Hexvalue]	[BitField]
1	R	10 11 12 13 14	IPOS	00 00 03 7B 4B	00000000

5.1 Status

The main status information is relevant to the HIPERFACE DSL® link. A quick report is provided by the arrow icon shown at the right-hand side of the “Status Bar”. Please refer to the description of the status bar for further details (see chapter 4.4).

A status word (“Online DSL Master Status”) is also shown as a hexadecimal value in the workspace (on the “DSL Status” push button).

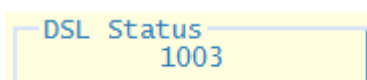

By pushing the “DSL Status” button a detailed information is shown as a list of bits. A set bit is depicted as a small red square:

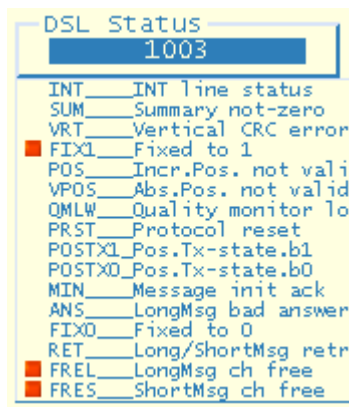

The meaning of each status bit is explained in detail in the HIPERFACE DSL[®] Manual.

For a quick overview the following common values are explained:

- A value of "1003" or "5003" notifies the user of a positive HIPERFACE DSL[®] link status.
- The value "5003" also notifies that a warning or error bit is set in one of the eight encoder status bytes (ENC_ST0..7, found under "Remote Registers"). Please note that the warning bit "Protocol Reset" is always set after establishing a HIPERFACE DSL[®] link.
- Values like "1B00", "3B00", or "5B00" indicate that the HIPERFACE DSL[®] link is down.

5.2 Tabs

At the top of the workspace are horizontally aligned tabs. Each is related to a specific function and can be pushed to activate or deactivate the function itself.

5.2.1 Master Registers

This function allows the user to access (Read / Write / Clear) all local registers of the HIPERFACE DSL® Encoder Interface (“DSL Master”).

For further details on the available registers and their function please refer to the HIPERFACE DSL® Manual.

The related workspace layout is shown below:

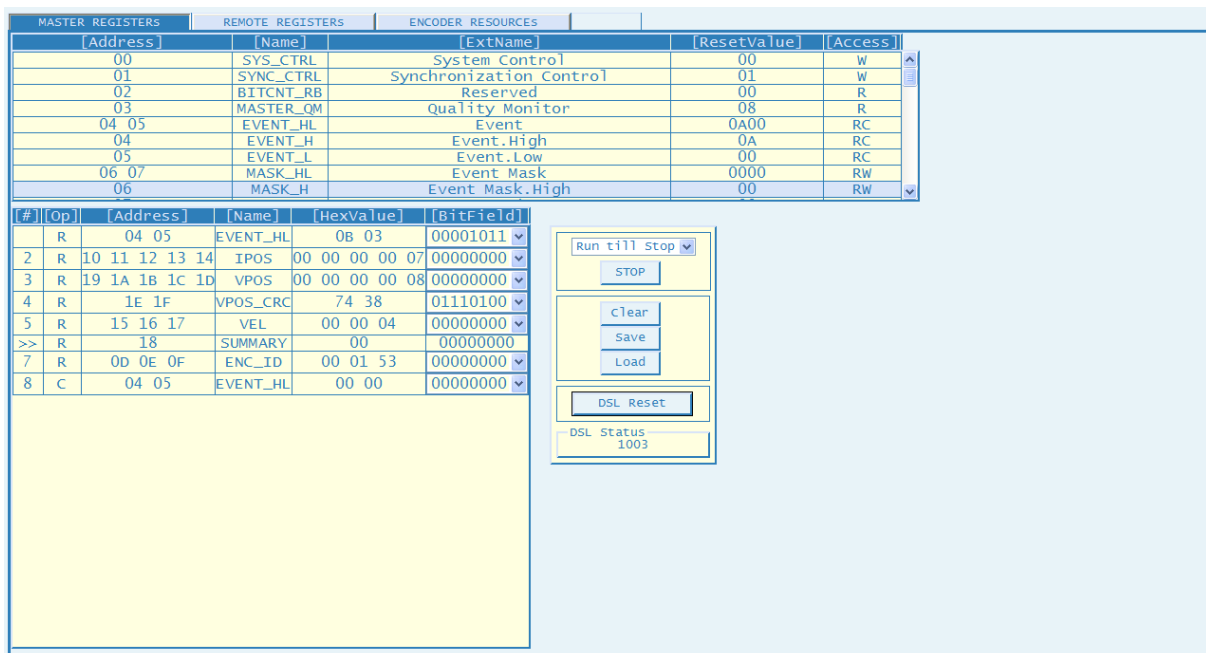

[Address]	[Name]	[ExtName]	[ResetValue]	[Access]
00	SYS_CTRL	System Control	00	W
01	SYNC_CTRL	Synchronization Control	01	W
02	BITCNT_RB	Reserved	00	R
03	MASTER_QM	Quality Monitor	08	R
04 05	EVENT_HL	Event	0A00	RC
04	EVENT_H	Event.High	0A	RC
05	EVENT_L	Event.Low	00	RC
06 07	MASK_HL	Event Mask	0000	RW
06	MASK_H	Event Mask.High	00	RW

[#]	[Op]	[Address]	[Name]	[HexValue]	[BitField]
1	R	04 05	EVENT_HL	0B 03	00001011
2	R	10 11 12 13 14	IPOS	00 00 00 00 07	00000000
3	R	19 1A 1B 1C 1D	VPOS	00 00 00 00 08	00000000
4	R	1E 1F	VPOS_CRC	74 38	01110100
5	R	15 16 17	VEL	00 00 04	00000000
>>	R	18	SUMMARY	00	00000000
7	R	0D 0E 0F	ENC_ID	00 01 53	00000000
8	C	04 05	EVENT_HL	00 00	00000000

The list-view at the top includes all available local registers.

Each row is related to a register and includes the following specific information:

- Register Address
- Register Name
- Register Extended Name
- Register Data on Reset
- Permitted Access Type (**R**-ead; **W**-rite; **C**-lear)

The appended list-view is relevant to the register access execution.

Each row includes the following specific information:

- Sequencer Index
- Access Type
- Register Address
- Register Name
- Register Data (hexadecimal value)
- Register Data (binary value)

5.2.2 Remote Registers

This function allows the user to access (Read / Write / Clear) interface registers of the HIPERFACE DSL[®] Encoder (“DSL Slave”), mirrored as remote registers of the HIPERFACE DSL[®] Encoder Interface (“DSL Master”).

For further details on the available registers and their function please refer to the HIPERFACE DSL[®] Manual.

The related workspace layout is shown below:

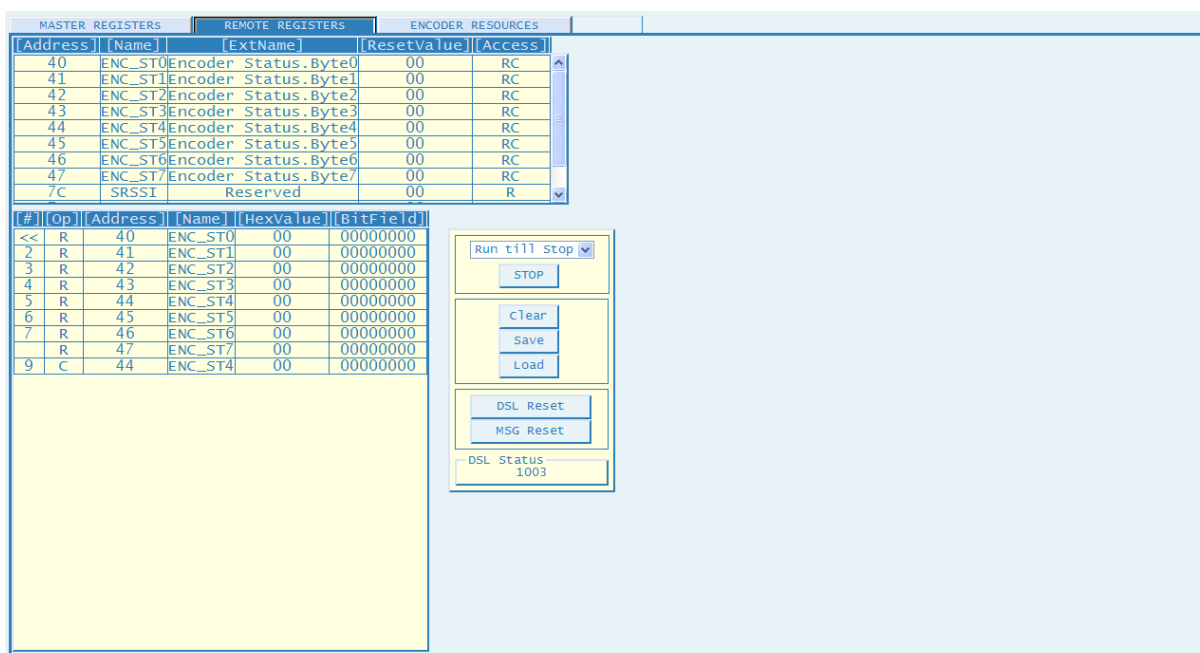

Address	Name	ExtName	ResetValue	Access
40	ENC_ST0	Encoder Status.Byte0	00	RC
41	ENC_ST1	Encoder Status.Byte1	00	RC
42	ENC_ST2	Encoder Status.Byte2	00	RC
43	ENC_ST3	Encoder Status.Byte3	00	RC
44	ENC_ST4	Encoder Status.Byte4	00	RC
45	ENC_ST5	Encoder Status.Byte5	00	RC
46	ENC_ST6	Encoder Status.Byte6	00	RC
47	ENC_ST7	Encoder Status.Byte7	00	RC
7C	SRSSI	Reserved	00	R

#	Op	Address	Name	HexValue	BitField
<<	R	40	ENC_ST0	00	00000000
2	R	41	ENC_ST1	00	00000000
3	R	42	ENC_ST2	00	00000000
4	R	43	ENC_ST3	00	00000000
5	R	44	ENC_ST4	00	00000000
6	R	45	ENC_ST5	00	00000000
7	R	46	ENC_ST6	00	00000000
	R	47	ENC_ST7	00	00000000
9	C	44	ENC_ST4	00	00000000

The list-view at the top includes all available remote registers.

Each row is related to a register and is showing the following specific information:

- Register Address
- Register Name
- Register Extended Name
- Register Data on Reset
- Permitted Access Type (**R**-ead; **W**-rite; **C**-lear)

PGT-09-S[®]

The appended list-view is relevant to the register access execution.

Each row is including the following specific information:

- Sequencer Index
- Access Type
- Register Address
- Register Name
- Register Data (hexadecimal value)
- Register Data (binary value)

5.2.3 Encoder Resources

This function allows the user to access (Read / Write) all parameter resources of the HIPERFACE DSL[®] Encoder.

For further details on the available resources and their function please refer to the specific HIPERFACE DSL[®] Encoder datasheet along with further protocol details specified by the HIPERFACE DSL[®] Manual.

The related workspace layout is shown below:

The screenshot displays the software interface for accessing encoder resources. It features a main table with columns for Node, Name, RID, Size, Access, Psw, TOut, Address, and Type. Below this is a detailed view of a selected resource, showing its name, offset, hex value, bit field, and RAE. To the right, there is a control panel with buttons for Run, Clear, Save, Load, and DSL Reset, along with a status indicator for DSL Status.

[Node]	[Name]	[RID]	[Size]	[Access]	[Psw]	[TOut]	[Address]	[Type]
Identification Node	EEPROM Size	087	2	R		5	FFFF	Sys-RAM
Monitoring Node	LED Current	0c3	2	R		5	0002	Function
Administration Node	Reset	100	0	W	#0	0	FFFF	Function
Counter Node	Increment Counter	121	0	W		30	FFFF	Function
Data Storage Node	Create/Delete File	133	14	W	#0	70	FFFF	Function
Data SensorHub Node	_???							
Production Node	Read Random Diodes	189	2	R	#7	10	FFFF	Function

#]	[Op]	[Name]	[Offset]	[HexValue]	[BitField]	[RAE]
1	R	Encoder_Type		00 02	00000000	
2	R	Range		00 00 10 00	00000000	
3	R	Resolution		00 10 00 00	00000000	
4	R	Type_Code_Name	0000	53 4B 4D 33 36 2D 44 46	01010011	
5	R	EEPROM_Size		08 00	00001000	
6	R	Temperature		01 7F	00000001	
7	R	LED_Current		00 62	00000000	
	R	Read_Counter		00 00 00 00	00000000	
9	W	Increment_Counter				
10	W	Set_Position		00 00 00 00 00 00 00 00	00000000	
11	W	Reset				
12	W	Create/Delete_File	0140	???		

The list-view at the top includes all available resources of all HIPERFACE DSL[®] Encoders.

Please note that individual encoders might not implement all resources. This is indicated in the product datasheet.

Each row is related to a specific “Group of Resources” (a node of the resource tree). the following specific information is listed:

- Node Name
- Resource Name
- Resource Identifier (RID)
- Resource Size (Bytes)
- Permitted Access Type (**R**-ead; **W**-rite)
- Access Level (the minimum required)
- Resource Timeout (ms)
- Resource Address

PGT-09-S®

- Resource Type

The appended list-view is relevant to the resource access execution.

Each row is including the following specific information:

- Sequencer Index
- Access Type
- Resource Name
- Resource Data Offset
- Hexadecimal Data Value
- Binary Data Value
- Resource Access Error-Code

The control panel on this page also contains an additional field showing the currently set access level for resource access.

Please set the desired access level by using the resource “Set Access Level” in the “Administration Node”.

6 Slave Mode

The Slave mode provides the user with specific functionalities for emulating a HIPERFACE DSL[®] Encoder. The PGT-09-S in Slave mode implements full HIPERFACE DSL[®] link support (position, status, messages) and a reduced set of resources.

This mode is useful for testing and validating the implementation of the HIPERFACE DSL[®] Encoder Interface (“DSL Master”). Along with the possibility to generate functional errors (EGx), a special functionality allows user even to force bit-errors in the basic DSL bit-frame, the so called, “Horizontal Frame” (H-FRAME). Note that “Power-User” access profile is required to make it available (see chapter 4.3.3).

PGT-09-S®

6.1 Status

The main status information is relevant to the HIPERFACE DSL® link. A quick report is provided by the arrow icon shown at the right-hand side of the “Status Bar”. Please refer to the description of the Status Tab for further details (chapter 4.4).

6.2 Tabs

At the top of the workspace tabs are displayed. Each is related to a specific function and can be pushed to activate or deactivate the function itself.

6.2.1 Encoder Resources

This function allows the user to examine the list of resources implemented in the emulated HIPERFACE DSL® Encoder.

For further details on the available resources and their function please refer to the HIPERFACE DSL® Manual.

The related workspace layout is shown below:

ENCODER_RESOURCES		ENCODER_EMULATION		FAULTY_DSL-H-FRAME			
[Node]	[Name]	[RID]	[Size]	[R_AccLev]	[W_AccLev]	[TOut]	[Type]
Identification Node	Encoder Type	080	2	0	6	5	Sys-RAM
Monitoring Node	_???						
Administration Node	Set Position	101	8	#	2	40	Function
Counter Node	Read Counter	120	4	0	7	5	Sys-RAM
Data Storage Node	_???						
Data SensorHub Node	_???						
Production Node	???						

6.2.2 Encoder Emulation

The emulated HIPERFACE DSL® Encoder includes a “position generator” running at constant speed. Besides, specific error codes can be generated on demand.

This function allows the user to set up the parameters of the emulated HIPERFACE DSL[®] Manual Encoder, specifically:

- Initial position value
- Position increment on every HIPERFACE DSL[®] frame
- Error codes

The screenshot below shows the related page and the objects to be used for setting the parameters referred above.

ENCODER RESOURCES	ENCODER EMULATION	FAULTY DSL-H-FRAME								
<p>POSITION</p> <p>INITIAL POSITION <input type="text" value="1122334455"/></p> <p>POSITION INCREMENT <input type="text" value="01"/></p>										
<p>ERROR CODES</p> <table border="1"> <tr> <td> <p>EG0</p> <p><input type="text" value="00"/></p> <input type="checkbox"/> AgBl & Tracking not Sync <input type="checkbox"/> AgBl Error <input type="checkbox"/> Vector Length <input type="checkbox"/> Tracking Error <input type="checkbox"/> Reserved <input type="checkbox"/> Test in Progress <input type="checkbox"/> Acceleration Overflow <input type="checkbox"/> Protocol Reset </td> <td> <p>EG1-Position</p> <p><input type="text" value="00"/></p> <input type="checkbox"/> Reserved <input type="checkbox"/> Reserved <input type="checkbox"/> Sync mismatch <input type="checkbox"/> Reserved <input type="checkbox"/> M-Turn-3 error <input type="checkbox"/> M-Turn-2 error <input type="checkbox"/> M-Turn-1 error <input type="checkbox"/> S-Turn error </td> <td> <p>EG2-Init</p> <p><input type="text" value="00"/></p> <input type="checkbox"/> Memory error <input type="checkbox"/> Sensor error <input type="checkbox"/> Intern.communication error <input type="checkbox"/> Intern.processor error <input type="checkbox"/> Intern.checksum error <input type="checkbox"/> Reserved <input type="checkbox"/> Wrong intern.angle offset <input type="checkbox"/> Wrong calib. data </td> <td> <p>EG3-Monitor</p> <p><input type="text" value="00"/></p> <input type="checkbox"/> Reserved <input type="checkbox"/> Reserved <input type="checkbox"/> Reserved <input type="checkbox"/> Intern.monitoring error <input type="checkbox"/> Counter overflow <input type="checkbox"/> Critical intern.supply volt. <input type="checkbox"/> Critical LED current <input type="checkbox"/> Critical temperature </td> </tr> <tr> <td> <p>EG4-Resources</p> <p><input type="text" value="00"/></p> <input type="checkbox"/> Reserved <input type="checkbox"/> Reserved <input type="checkbox"/> Reserved <input type="checkbox"/> Reserved <input type="checkbox"/> File Access error <input type="checkbox"/> Internal error <input type="checkbox"/> Permission error <input type="checkbox"/> Invalid argument </td> <td> <p>EG5-Userwarning</p> <p><input type="text" value="00"/></p> <input type="checkbox"/> Warning 7 <input type="checkbox"/> Warning 6 <input type="checkbox"/> Warning 5 <input type="checkbox"/> Warning 4 <input type="checkbox"/> Warning 3 <input type="checkbox"/> Warning 2 <input type="checkbox"/> Warning 1 <input type="checkbox"/> Warning 0 </td> <td> <p>EG6-Reserved</p> <p><input type="text" value="00"/></p> <input type="checkbox"/> Reserved <input type="checkbox"/> Reserved <input type="checkbox"/> Reserved <input type="checkbox"/> Reserved <input type="checkbox"/> Reserved <input type="checkbox"/> Reserved <input type="checkbox"/> Reserved </td> <td> <p>EG7-Reserved</p> <p><input type="text" value="00"/></p> <input type="checkbox"/> Reserved <input type="checkbox"/> Reserved <input type="checkbox"/> Reserved <input type="checkbox"/> Reserved <input type="checkbox"/> Reserved <input type="checkbox"/> Reserved <input type="checkbox"/> Reserved </td> </tr> </table>			<p>EG0</p> <p><input type="text" value="00"/></p> <input type="checkbox"/> AgBl & Tracking not Sync <input type="checkbox"/> AgBl Error <input type="checkbox"/> Vector Length <input type="checkbox"/> Tracking Error <input type="checkbox"/> Reserved <input type="checkbox"/> Test in Progress <input type="checkbox"/> Acceleration Overflow <input type="checkbox"/> Protocol Reset	<p>EG1-Position</p> <p><input type="text" value="00"/></p> <input type="checkbox"/> Reserved <input type="checkbox"/> Reserved <input type="checkbox"/> Sync mismatch <input type="checkbox"/> Reserved <input type="checkbox"/> M-Turn-3 error <input type="checkbox"/> M-Turn-2 error <input type="checkbox"/> M-Turn-1 error <input type="checkbox"/> S-Turn error	<p>EG2-Init</p> <p><input type="text" value="00"/></p> <input type="checkbox"/> Memory error <input type="checkbox"/> Sensor error <input type="checkbox"/> Intern.communication error <input type="checkbox"/> Intern.processor error <input type="checkbox"/> Intern.checksum error <input type="checkbox"/> Reserved <input type="checkbox"/> Wrong intern.angle offset <input type="checkbox"/> Wrong calib. data	<p>EG3-Monitor</p> <p><input type="text" value="00"/></p> <input type="checkbox"/> Reserved <input type="checkbox"/> Reserved <input type="checkbox"/> Reserved <input type="checkbox"/> Intern.monitoring error <input type="checkbox"/> Counter overflow <input type="checkbox"/> Critical intern.supply volt. <input type="checkbox"/> Critical LED current <input type="checkbox"/> Critical temperature	<p>EG4-Resources</p> <p><input type="text" value="00"/></p> <input type="checkbox"/> Reserved <input type="checkbox"/> Reserved <input type="checkbox"/> Reserved <input type="checkbox"/> Reserved <input type="checkbox"/> File Access error <input type="checkbox"/> Internal error <input type="checkbox"/> Permission error <input type="checkbox"/> Invalid argument	<p>EG5-Userwarning</p> <p><input type="text" value="00"/></p> <input type="checkbox"/> Warning 7 <input type="checkbox"/> Warning 6 <input type="checkbox"/> Warning 5 <input type="checkbox"/> Warning 4 <input type="checkbox"/> Warning 3 <input type="checkbox"/> Warning 2 <input type="checkbox"/> Warning 1 <input type="checkbox"/> Warning 0	<p>EG6-Reserved</p> <p><input type="text" value="00"/></p> <input type="checkbox"/> Reserved <input type="checkbox"/> Reserved <input type="checkbox"/> Reserved <input type="checkbox"/> Reserved <input type="checkbox"/> Reserved <input type="checkbox"/> Reserved <input type="checkbox"/> Reserved	<p>EG7-Reserved</p> <p><input type="text" value="00"/></p> <input type="checkbox"/> Reserved <input type="checkbox"/> Reserved <input type="checkbox"/> Reserved <input type="checkbox"/> Reserved <input type="checkbox"/> Reserved <input type="checkbox"/> Reserved <input type="checkbox"/> Reserved
<p>EG0</p> <p><input type="text" value="00"/></p> <input type="checkbox"/> AgBl & Tracking not Sync <input type="checkbox"/> AgBl Error <input type="checkbox"/> Vector Length <input type="checkbox"/> Tracking Error <input type="checkbox"/> Reserved <input type="checkbox"/> Test in Progress <input type="checkbox"/> Acceleration Overflow <input type="checkbox"/> Protocol Reset	<p>EG1-Position</p> <p><input type="text" value="00"/></p> <input type="checkbox"/> Reserved <input type="checkbox"/> Reserved <input type="checkbox"/> Sync mismatch <input type="checkbox"/> Reserved <input type="checkbox"/> M-Turn-3 error <input type="checkbox"/> M-Turn-2 error <input type="checkbox"/> M-Turn-1 error <input type="checkbox"/> S-Turn error	<p>EG2-Init</p> <p><input type="text" value="00"/></p> <input type="checkbox"/> Memory error <input type="checkbox"/> Sensor error <input type="checkbox"/> Intern.communication error <input type="checkbox"/> Intern.processor error <input type="checkbox"/> Intern.checksum error <input type="checkbox"/> Reserved <input type="checkbox"/> Wrong intern.angle offset <input type="checkbox"/> Wrong calib. data	<p>EG3-Monitor</p> <p><input type="text" value="00"/></p> <input type="checkbox"/> Reserved <input type="checkbox"/> Reserved <input type="checkbox"/> Reserved <input type="checkbox"/> Intern.monitoring error <input type="checkbox"/> Counter overflow <input type="checkbox"/> Critical intern.supply volt. <input type="checkbox"/> Critical LED current <input type="checkbox"/> Critical temperature							
<p>EG4-Resources</p> <p><input type="text" value="00"/></p> <input type="checkbox"/> Reserved <input type="checkbox"/> Reserved <input type="checkbox"/> Reserved <input type="checkbox"/> Reserved <input type="checkbox"/> File Access error <input type="checkbox"/> Internal error <input type="checkbox"/> Permission error <input type="checkbox"/> Invalid argument	<p>EG5-Userwarning</p> <p><input type="text" value="00"/></p> <input type="checkbox"/> Warning 7 <input type="checkbox"/> Warning 6 <input type="checkbox"/> Warning 5 <input type="checkbox"/> Warning 4 <input type="checkbox"/> Warning 3 <input type="checkbox"/> Warning 2 <input type="checkbox"/> Warning 1 <input type="checkbox"/> Warning 0	<p>EG6-Reserved</p> <p><input type="text" value="00"/></p> <input type="checkbox"/> Reserved <input type="checkbox"/> Reserved <input type="checkbox"/> Reserved <input type="checkbox"/> Reserved <input type="checkbox"/> Reserved <input type="checkbox"/> Reserved <input type="checkbox"/> Reserved	<p>EG7-Reserved</p> <p><input type="text" value="00"/></p> <input type="checkbox"/> Reserved <input type="checkbox"/> Reserved <input type="checkbox"/> Reserved <input type="checkbox"/> Reserved <input type="checkbox"/> Reserved <input type="checkbox"/> Reserved <input type="checkbox"/> Reserved							

Two parameters are relevant to the “position generator” and they are set with two text fields under the header “POSITION”.

By clicking on the field an edit session can start. The “Enter” key closes the edit session and makes the value active.

POSITION	
INITIAL POSITION	<input type="text" value="00FFFEA5C"/>
POSITION INCREMENT	<input type="text" value="05"/>

The error codes are grouped according to the HIPERFACE DSL[®] Encoder datasheet. Each error bit of each group (excluding those reserved) can be set or reset by clicking on the associated box as shown below:

PGT-09-S®

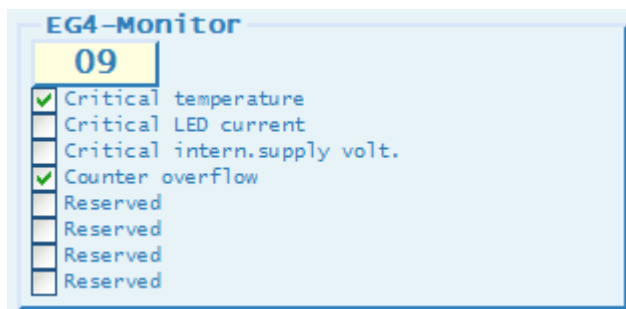

Above of the error bit checkboxes a field functioning as a push button is placed to show the corresponding error byte value. To make an error code active please push this error byte push button.

6.2.3 Faulty DSL H-FRAME

The “Faulty DSL H-FRAME” is a special functionality, useful to generate specific error conditions in the basic DSL bit-frame (H-FRAME), in order to test the DSL system under faulty conditions. Note that “Power-User” access profile is required (see chapter 4.3.3).

Different error types can be configured to affect the selected bits (sequential) of the frame, at the raw data-stream level (functional errors) or at the encoded data-stream level (communication errors simulation). The error condition can even be triggered by combining internal and external events (internal protocol states and external signal, fed thru the BNC connector).

Here is the basic steps to make it working:

- Raw / Encoded bits selection
- Fault configuration
- Trigger configuration
- Configured fault setting
- Fault status monitoring

The specific information on the fault status is a direct feedback on the “error generator” status; the effects of the generated error must be captured elsewhere (e.g.: by using a further tool in the Master Mode or Analyzer Mode).

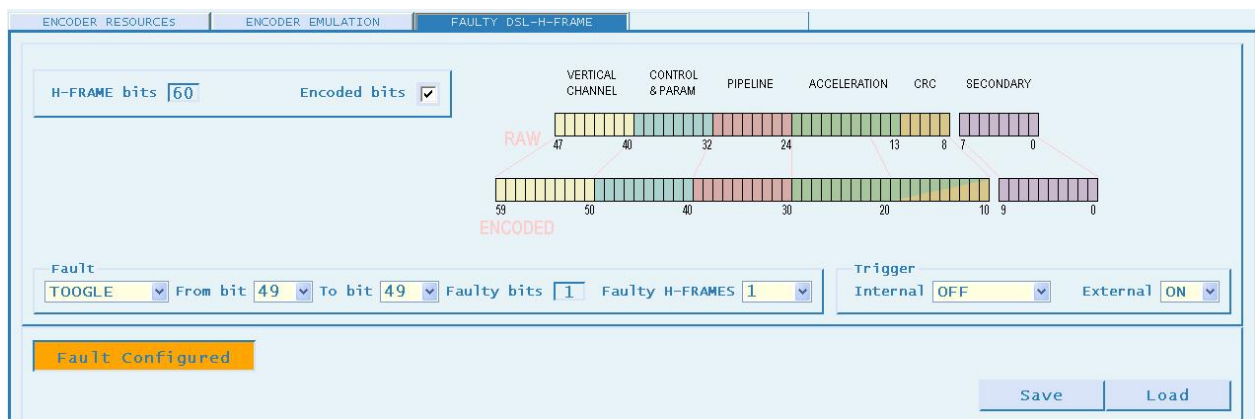

PGT-09-S

The Raw / Encoded bits selection is achieved by un-checking / checking the specific checkbox in the panel placed on the left-top side where the corresponding total bits in the H-FRAME are also shown. On the mid-right-top side the basic specification of the H-FRAME format (Raw / Encoded) is shown as well.



Please note the bit enumeration: the 1st-transmitted bit is referred as bit47 (Raw) or bit59 (Encoded); hence the bit0 is the one transmitted last.

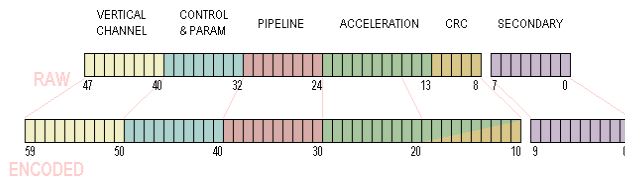

The following figure shows some more bit details:

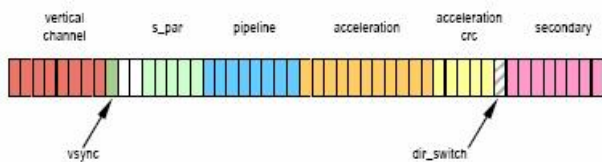

Besides the selection above defining the fault target, a complete fault setup is also requiring the fault specification, defined based on the selectors available in the specific panel, the following one:



Starting from the left-end-side, the first drop-down selector defines the “fault type” affecting the range of the sequential bits (up to the whole frame), specified by means of both the next two specific selectors (“From...To”). The total affected bits are also shown beside.

The selectable self-explained fault types are shown hereafter; the topmost selection (NONE) can be simply used to make the fault configuration inactive.



A further specification is required; i.e., the quantity of the affected H-FRAME’s; that can be specified based on the selector placed on the right-end side.

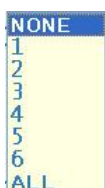



Again, the topmost selection (NONE) can be used to make the fault configuration inactive.

PGT-09-S®

Ultimately an optional specification refers to the event (state / signal) triggering the configured fault action. The trigger, if enabled, can be based on two different and independent types of event; that is, a specific internal protocol state and / or an external signal, fed thru the BNC connector.

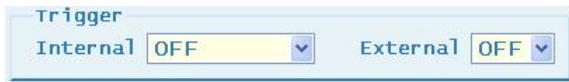
The trigger setup can be done by using the following selectors placed in a panel on the right-end-side:



The external trigger is disabled / enabled by means of the specific 2-way selector .

The internal trigger is instead enabled when one internal protocol state is selected; that is, one different than the topmost selection (OFF) disabling the specific trigger use.



Referring to the protocol states, a list with a short description follows:

SP_RESET	DSL slave interface reset (protocol stack restart)
SP_SHOW_ID	Encoder ID sent to DSL master
SP_START	Waiting a vertical sync to enter SP_TX0...TX7 loop
SP_TX0	The 1 st byte of the vertical channel (Summary) is generated
SP_TX1...5	Refer to the absolute position (MS-Byte...LS-Byte) slicing
SP_TX6...7	Refer to the CRC (15:0) of the vertical channel

VERTICAL CHANNEL

SUMMARY
POS(39:32)
POS(31:24)
POS(23:16)
POS(15:8)
POS(7:0)
CRC(15:8)
CRC(7:0)

Besides the diagram showing the DSL slave states transition is hereafter enclosed too

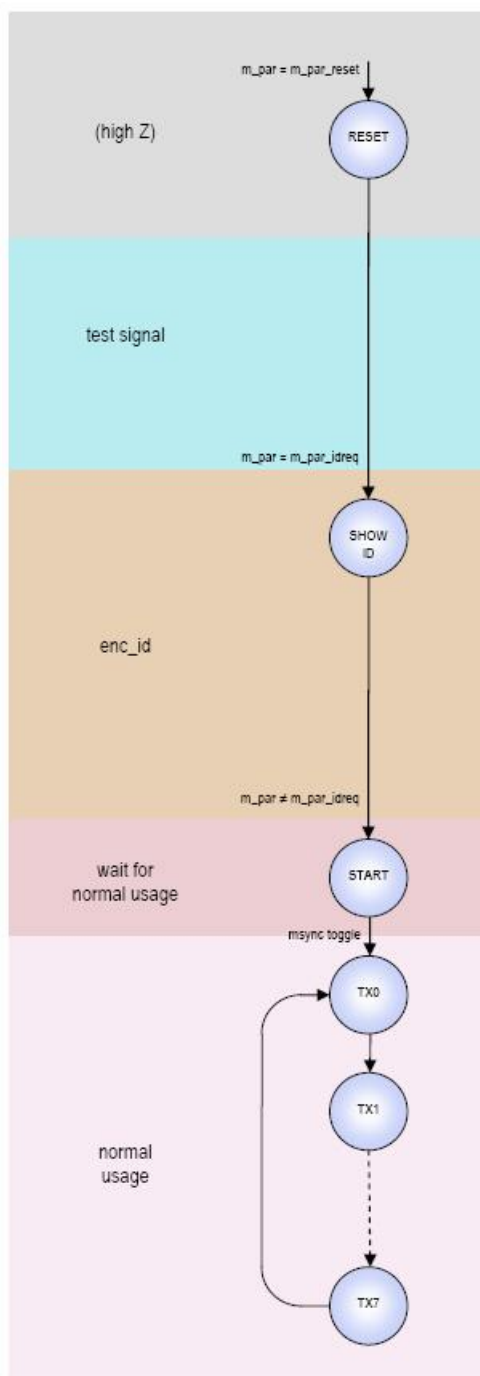

Please, refer to the specific DSL protocol description for the most complete description of the internal protocol states handling.

PGT-09-S®

Once the fault parameters are selected, they have to be transferred to the fault generator; so, a specific push-button shown on the left-bottom has to be used for making the shown setup active.



The button above is shown on condition that both the fault type and the faulty frames are selected different than “NONE”; additionally the fault generation must be in the “OFF” state (inactive). Such a condition can be verified looking at the text field placed above the button.



- Please, note that anytime the setup is changed the current active configuration is reset and the inactive status (OFF) is entered.

On pushing the aforementioned button, the current setup is uploaded and then the fault generator is activated; please, monitor the status transitions shown in the specific status field above the button. Here is shown the fault status change sequence:

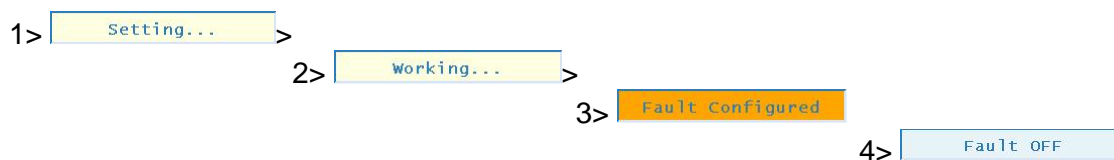

Please, note the 3rd state is held until the fault occurs. So, if any trigger event is configured, the 3rd state is hold while the event is not occurring and the setup is not changed; whereas, the 3rd state could even be not visible on un-triggered fault generation

An useful feature is additionally available to the user; that is, the possibility to save and reload any fault setup. The saved setup are shown into a drop-down list to be quickly selected. Two specific push-buttons are located on the right-bottom; above them, the saved setup list and the current selected setup are shown.

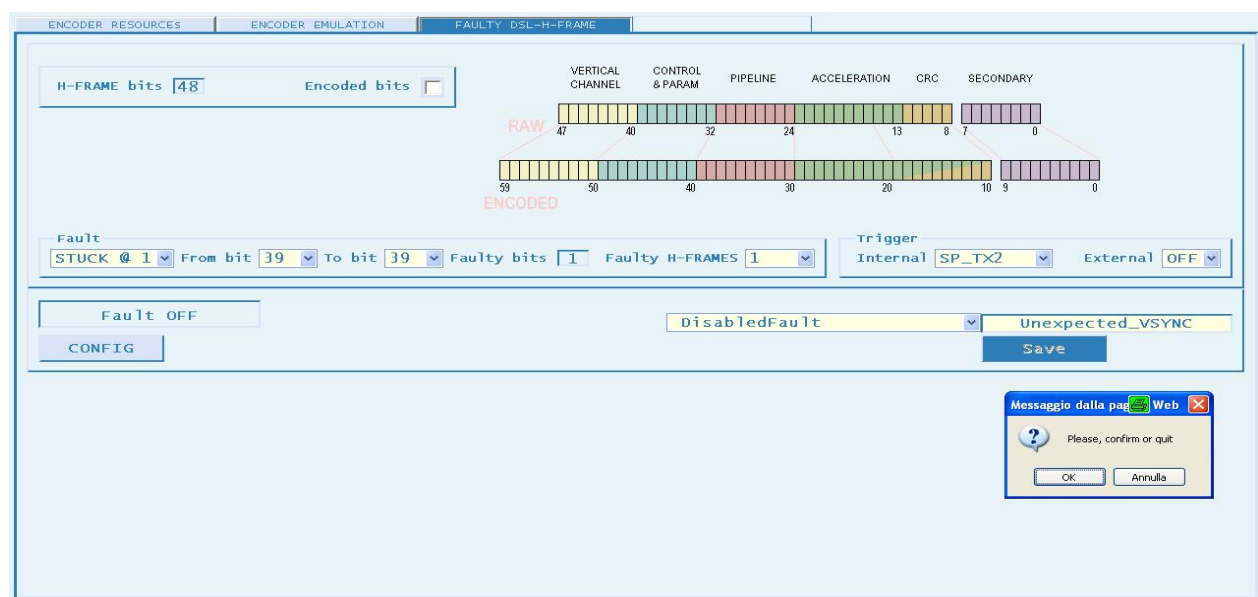

PGT-09-S

On the save operation, the text-field above the buttons is suitable for editing a setup name (an ASCII identifier, 16 characters long) that is accepted and used to identify the setup on the save confirmation.

The user can confirm to proceed processing the shown identifier by using the ENTER key; the ESC key has instead to be used to abandon.



On the load operation, the text-field above the buttons is not editable, showing instead the identifier selected from the list and picked up by double-clicking the left-button of the mouse. As for the save operation, the ENTER key or the ESC have to be used to proceed or abandon the load operation.

Please, note that the double-click over the list is processed to choose an identifier as the current one, both for save and load operations.

Note besides that the top-most selection (arrow sequence) is suitable for closing the list upon a single mouse click.

7 Analyzer Mode

The Analyzer mode provides the user with data-logger functionalities in order to monitor link behavior. Data-logging is based on user set conditions, and it is possible to trigger with an external signal (see TRIGGER connector, chapter 3.4).

The Analyzer mode allows a deep investigation of link issues on protocol level. In order to use this mode effectively please consult the HIPERFACE DSL® Manual.

The screenshot shows the HIPERFACE DSL Analyzer Mode interface. The top bar includes the SICK STEGMANN logo, the product name 'HIPERFACE DSL', and the window title 'DSL-AN-33333333 [ANALYZER MODE]'. The date and time are '19.01.10 10:52:05'. Below the top bar, there are tabs for 'CONFIGURATION' and 'DATA ACQUISITION'. The 'DATA ACQUISITION' tab is active, showing 'Acquisition Mode' set to 'Position' and 'Trigger' set to 'OFF'. There are 'START' and 'Completed' buttons. The time range is 'T/Start: 19.01.2010 10:50:29' to 'T/Stop: ' (empty), with 'T/First: 19.01.2010 10:50:42' and 'T/Last: 19.01.2010 10:50:43'. A table displays the following data:

###	Event	Time	Summary	Vertical Pos	Vertical Crc	Integrated Pos	Watch
463	0058E7AF	80	003F2A805C	65EE	003F2A8056		
464	0058EB6F	80	003F2A805C	65EE	003F2A8055		
465	0058EF2F	80	003F2A805C	65EE	003F2A8055		
466	0058F2EF	80	003F2A805C	65EE	003F2A8061		
467	0058F6AF	80	003F2A805A	269B	003F2A8055		
468	0058FA6F	80	003F2A805A	269B	003F2A8053		
469	0058FE2F	80	003F2A805A	269B	003F2A8059		
470	005901EF	80	003F2A805A	269B	003F2A805B		
471	005905AF	80	003F2A805A	269B	003F2A805F		
472	0059096F	80	003F2A805A	269B	003F2A8054		
473	00590D2F	80	003F2A805A	269B	003F2A805A		
474	005910EF	80	003F2A805A	269B	003F2A8062		
475	005914AF	80	003F2A8055	81FF	003F2A8051		
476	0059186F	80	003F2A8055	81FF	003F2A8056		
477	00591C2F	80	003F2A8055	81FF	003F2A8052		
478	00591FEF	80	003F2A8055	81FF	003F2A805C		
479	005923AF	80	003F2A8055	81FF	003F2A8060		
480	0059276F	80	003F2A8055	81FF	003F2A8052		

At the bottom, it shows 'Records: 480/2048' and an 'UpLoad' button.

7.1 Status

The main status information is relevant to the HIPERFACE DSL® link. A quick report is provided by the arrow icon shown at the right-hand side of the "Status Bar". Please refer to the description of the Status Tab for further details (chapter 4.4).

7.2 Tabs

At the top of the workspace are horizontally aligned tabs. Each is related to a specific function and can be pushed to activate or deactivate the function itself.

7.2.1 Configuration

This function allows the user to configure data-logging by setting:

- the acquisition mode
- the acquisition trigger
- the events log filter (“Watch Filter Mask”)

For further details on the configuration above, please, refer to the Analyzer Data Formats (chapter 6) along with further protocol details specified by the HIPERFACE DSL® Manual.

The related workspace layout is shown below:



The screenshot shows the configuration interface for the PGT-09-S analyzer. The interface is divided into several sections:

- Acquisition Mode:** Position
- Acquisition Trigger Setup:** Source Error Messages, Mask 00, Mode .., Threshold 00
- Watch Filter Mask:** 00000001F1F000
- Error Messages:** 00, SUMMARY.7, SUMMARY.6, SUMMARY.5, SUMMARY.4, SUMMARY.3, SUMMARY.2, SUMMARY.1, SUMMARY.0
- State Machines:** 00, MPSTATE.3, MPSTATE.2, MPSTATE.1, MPSTATE.0, SPSTATE.3, SPSTATE.2, SPSTATE.1, SPSTATE.0
- Data Link Layer:** 00, Reserved, BbLOBERR.6, BbLOBERR.5, BbLOBERR.4, BbLOBERR.3, BbLOBERR.2, BbLOBERR.1, BbLOBERR.0
- Position:** 00, Reserved, LOCK, FIRST, MSYNC, AUX, ZPOS-ERR, ACC-CRC-ERR, VERT-ERR
- Master-Slave MSG:** 1F, Reserved, MS-SHORTMSG-CRC-ERR, MS-LONGMSG-CRC-ERR, MPAR.4, MPAR.3, MPAR.2, MPAR.1, MPAR.0
- Slave-Master MSG:** 1F, Reserved, SM-SHORTMSG-CRC-ERR, SM-LONGMSG-CRC-ERR, SPAR.4, SPAR.3, SPAR.2, SPAR.1, SPAR.0
- Signal Strength:** 00, Reserved, MS-RSSI.2, MS-RSSI.1, MS-RSSI.0, SM-RSSI.3, SM-RSSI.2, SM-RSSI.1, SM-RSSI.0
- Quality Monitor:** 00, Reserved, Reserved, Reserved, QUALITY-MONITOR.3, QUALITY-MONITOR.2, QUALITY-MONITOR.1, QUALITY-MONITOR.0

At the bottom of the interface, there are buttons for Upload, Save, and Restore.

Please note that upon entering this page the currently active configuration is shown. Any change must be confirmed by the **Config Update** push button. As long as a changed configuration is not confirmed, a tab switch is not possible. After updating a configuration the push button goes hidden to notify of a successful change.

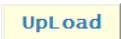
Relevant to the configuration setup more push buttons are available:

- | | |
|---|---|
|  | Read out the active configuration setup (undoing unconfirmed changes) |
|  | Save the shown configuration setup (single storage entry only) |
|  | Restore previously saved configuration setup |

PGT-09-S®**Acquisition Mode**

The acquisition mode can be set by using the selector placed on the top left-hand side:

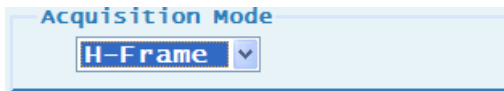

The selectable modes are the following:

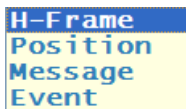

The “H-Frame” mode allows logging raw protocol data exchanged on the HIPERFACE DSL® link.

The “Position” mode allows logging position acquisition data as available in the HIPERFACE DSL® Encoder Interface (DSL Master).

The “Message” mode is specifically related to Short and Long Message exchange (HIPERFACE DSL® Encoder resource access).

The “Event” mode is suitable to log specific events:

- Watch signal changes (based on the Watch Filter, see configuration above)
- Trigger event (if configured)
- Timestamp counter overflow

Trigger Setup

The trigger for logging data can be defined based on four parameters.

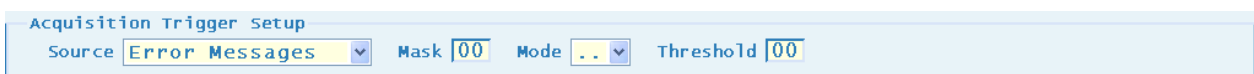

The trigger depends on the result of a logical comparison defined through the following settings:

- Source
- Mask
- Mode
- Threshold

The trigger “Source” field refers to the byte of the Watch Filter Mask to be used for triggering.

Please note that each byte is referred by the associated watch filter name as displayed on screen:

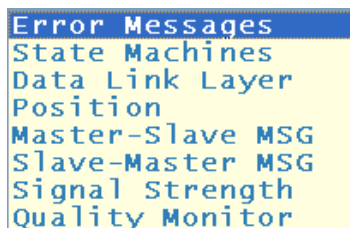

The “Mask” field (1 byte) is suitable to mask bits of the selected trigger source. Click on it to start an edit session. The “Enter-Key” is required to confirm the edited value.

The “Mode” field defines the logical operation to be applied on the selected and masked trigger source. A drop-down box allows to choose the desired operation. Please note that the first selection defines the “no trigger” condition (*trigger disabled*).



The symbol definition is common to some software development languages:

- “Equal” / “Not Equal”
- ” Less Than” / “Less Than or Equal”
- “Greater Than” / “Greater Than or Equal”

The “Threshold” field (1 byte) is suitable to define the value to which the masked trigger source is compared with. Click on it to start an edit session. The “Enter-Key” is required to confirm the edited value.

Watch Filter Mask

The “Watch Filter Mask” (64-bit mask) is used to filter which events are actually logged when triggered. The text field shows the active pattern based on the bit patterns set by the user in the check boxes below it:

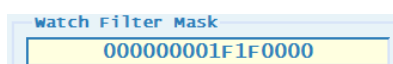

This field can be used as a push-button. On clicking the shown pattern is made active.

The filter bit patterns can be defined bit-by-bit by using the associated checkboxes: by clicking the user can toggle the selected bit. On top of the checkboxes corresponding text fields functioning as push buttons are placed and show the corresponding byte value. To make their values active they have to be clicked.

PGT-09-S®

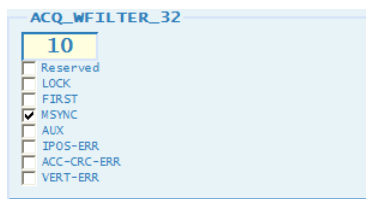

The meaning of the event bits is explained in chapter 6.

7.2.2 Data Acquisition

In this tab the user can control and monitor the data-logging process.

The related workspace layout is shown below:

###	Event	Time	Master	Slave1	Slave2	8b10bF lag	8b10bErr	watch
1015		002A8EAF	50	EE90000E4	94	00	00	
1016		002A926F	10	801000FFD0	1C	02	00	
1017	w	002A926F						809800401010260F
1018		002A962F	10	001000003A	FD	00	00	
1019		002A99EF	10	3F1000FEB2	FD	00	00	
1020		002A9DAF	10	2A100000E4	FD	00	00	
1021		002AA16F	10	8010000186	FD	00	00	
1022		002AA52F	10	511000FE6C	FD	00	00	
1023		002AA8EF	10	731000FFF5	B2	00	00	
1024		002AACAF	10	8A90000070	41	00	00	
1025	<<T>>	002AAD40						
1026		002AB06F	50	8010000158	9C	02	00	
1027	w	002AB06F						809800501010260F
1028		002AB42F	50	001000FEDD	FD	00	00	
1029		002AB7EF	50	3F1000FFF5	FD	00	00	
1030		002ABBAF	50	2A10000055	FD	00	00	
1031		002ABF6F	50	801000FFF5	FD	00	00	
1032		002AC32F	50	4B1000FF61	FD	00	00	

Three main sections can be identified within the workspace:

- Header
- Main Window
- Bottom Section

The Header is constituted of two bars (an upper-bar and a lower-bar) related to acquisition setup and acquisition status.

On the left-hand side of the upper-bar the active acquisition mode and the trigger configuration status are shown:

On the right-hand side of the upper-bar a push button to start and stop the acquisition along with a field showing the acquisition status are placed:

as shown upon start to stop a running acquisition.

as shown upon stop to start a new acquisition.

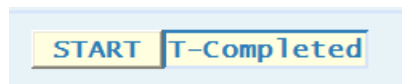
PGT-09-S®

shown on triggered acquisition completion.

On the lower-bar of the Header fields related to acquisition timestamps are placed, as shown below:

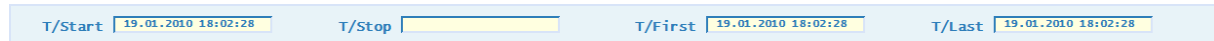

The timestamps refer to the following events:

- acquisition start
- acquisition stop
- first logged record
- last logged record

The list-view in the main window shows the logged records whose specific format is depending on the acquisition mode (see chapter 7.3):

###	Event	Time	Master	Slave1	Slave2	8b10bFlag	8b10bErr	Watch
1018		0052E62F	10	001000FFD0	FD	00	00	
1019		0052E9EF	10	3F1000FD14	FD	00	00	
1020		0052EDAF	10	2A10000503	FD	00	00	
1021		0052F16F	10	801000FE26	FD	00	00	
1022		0052F52F	10	4F1000FEB2	FD	00	00	
1023		0052F8EF	10	AD1000FFF5	B2	00	00	
1024		0052FCFA	10	A790000186	41	00	00	
1025	<<T>>	0052FD40						
1026		0053006F	50	801000017D	9C	02	00	
1027	w	0053006F						809800501010260F
1028		0053042F	50	001000FBAE	FD	00	00	
1029		005307EF	50	3F100003D6	FD	00	00	
1030		00530BAF	50	2A1000FEB2	FD	00	00	
1031		00530F6F	50	8010000112	FD	00	00	
1032		0053132F	50	4E1000FD14	FD	00	00	
1033		005316EF	50	3D10000205	AA	00	00	
1034		00531AAF	50	7E90000291	94	00	00	
1035		00531E6F	10	801000FC3C	1C	02	00	
1036		00531E6F						809800501010260F

Please note that the contents of the listed record fields can be copied and pasted into a text file or spreadsheet by clicking and dragging with a mouse and using appropriate Copy/Paste actions as provided by the web browser.

H-Frame mode record format

###	Event	Time	Master	Slave1	Slave2	8b10bFlag	8b10bErr	Watch
1493		005914AF	10	8A90000055	41	00	00	
1494		0059186F	50	80100000AE	9C	02	00	
1495	w	0059186F						809800501010260F

The record fields are defined as follows:

- **###** Record index
- **Event** Event code (if any)
- **Time** Timestamp of the record
- **Master** Master data packet (Encoder Interface -> Encoder)
- **Slave1** Primary slave data packet (Encoder -> Encoder Interface)
- **Slave2** Secondary slave data packet (Encoder -> Encoder Interface)
- **8b10bFlag** Data link layer encoding special characters

- **8b10bErr** Data link layer encoding errors
- **Watch** Watch signal changes related to an event

Position mode record format

###	Event	Time	Summary	Vertical Pos	Vertical Crc	Integrated Pos	Watch
6		003C5AEF	80	003F2A8050	E37E	003F2A8046	
7		003C5EAF	80	003F2A804E	3D53	003F2A804B	
8		003C626F	80	003F2A804E	3D53	003F2A804E	
9	w	003C626F					809800401010260F

The record fields are defined as follows:

- **###** Record index
- **Event** Event code (if any)
- **Time** Timestamp of the record
- **Summary** Summary bit byte
- **Vertical Pos** Vertical position (absolute position)
- **Vertical Crc** Vertical position CRC
- **Integrated Pos** Accumulated position
- **Watch** Watch signal changes related to an event

Message mode record format:

###	Event	Time	M/S	Msg Addr	LongMsg Offset	Msg Data	Msg Crc	Watch
1	w	00075B6F						80dc00501010260F
2		400E	M r	083	0000		C951	
3		4868	S r	083		534B4D33362D4446	1492	
4		51D0	M w	101		0000000000000000	9486	
5		42E6	S w	101			9486	
6		2CF4	M r	00			8775	
7		2D1A	S r	00		00	C68F	
8		33DA	M r	07			54C8	
9		3400	S r	07		52	749B	

The record fields are defined as follows:

- **###** Record index
- **Event** Event code (if any)
- **Time** Timestamp of the record
- **M/S** Message sender (Master or Slave) with Read / Write attribute
- **Msg Addr** Message address (2-nibble for ShortMsg; 3-nibble for LongMsg)
- **LongMsg Offset** Address offset (LongMsg only, if any)
- **Msg Data** Message data (if any)
- **Msg Crc** Message CRC
- **Watch** Watch signal changes related to an event

PGT-09-S®**Event mode record format:**

###	Event	Time	Watch
1	W	0055946F	809800501010260F
2	W	0055B26F	809800401010260F
3	W	0055D06F	809800501010260F
4	W	0055EE6F	809800401010260F
5	W	00560C6F	809800501010260F

The record fields are defined as follows:

- **###** Record index
- **Event** Event code
- **Time** Timestamp of the event
- **Watch** Watch signal changes related to an event

Additional notes:

- Event codes are identified as follows:
 - W identifies changes in watch signals
 - <<T>> identifies a trigger reference
 - TOVF! identifies a timestamp overflow (if any)
- the timestamp can have different resolution depending on the acquisition mode:
 - full (23bit, 13.56 ns) all modes but Message mode
 - reduced (14bit, 694 ns) Message mode

In the bottom section a bar is placed showing both the number of acquired records and those listed. Also, a push button is available to enable or disable storage of records in the PGT-09-S device.

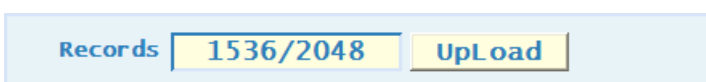

Note that the data acquisition is buffered and the buffer is dimensioned to store up to 2048 records.

Trigger

The acquisition trigger allows to log data only under specific conditions. Setting the trigger also allows the user to synchronize acquisition to an external signal (refer to the TRIGGER connection, chapter 3.4).

Please note that to configure the trigger based on an external signal the trigger source must include the "AUX" bit of the POSITION events byte.

Please note that the trigger is disabled on startup. If the trigger is disabled, all data on the HIPERFACE DSL® link is logged when starting an acquisition.

PGT-09-S

The trigger setup is handled by the Configuration function (see chapter 7.2.1). If the configured trigger condition occurs a started acquisition is stopped. The acquisition buffer is handled so that the record associated with the trigger is stored in the middle of the buffer. This way the logged records are equally split into half before and after the trigger.

Data logging

The data logging is a process collecting specific formatted records into the acquisition buffer (dimensioned to store up to 2048 records) on condition that:

- The acquisition mode is selected
- The acquisition process is activated (start button was pressed)
- The trigger condition if configured has occurred
- The data amount is available

The data logging can be differentiated by selecting the acquisition mode. It can be refined by setting a proper configuration.

Events filtering

The so called “events” (refer to the specific types specified above) are always logged in the acquisition buffer regardless of the active acquisition mode.

Therefore it is recommended to set up specific event filtering through the watch filter setup (refer to the Configuration function, chapter 7.2.1) to avoid that too many event records fill the acquisition buffer.

7.3 Analyzer Data Formats

Each Analyzer operating mode (see chapter 7.2.1) uses a different 128 bit data format to store logged entries. This chapter defines these data formats to allow identification of logged data.

Please note that by default unused bits in a log entry are not cleared. Therefore they can contain arbitrary data.

7.3.1 H-Frame Mode

The 128 bits of a log entry in H-Frame mode are specified as follows:

Bit position	Width	Value range	Meaning
127 (MSB)	1	0	Escape bit
126 ... 104	23	00 00 00 ... 7F FF FFh	Time stamp (full resolution, 13.56 ns)
103 ... 96	8	00 ... FFh	Master data (Encoder Interface -> Encoder)
95 ... 56	40	00 00 00 00 00 ... FF FF FF FF FFh	Primary slave data (Encoder -> Encoder Interface)
55 ... 48	8	00 ... FFh	Secondary slave data (Encoder -> Encoder Interface)
47 ... 40	8	00 ... FFh	Special character flag
47			Master data
46			Primary slave byte 1
45			Primary slave byte 2
44			Primary slave byte 3
43			Primary slave byte 4
42			Primary slave byte 5
41			Secondary slave
40	Reserved for future use		
39 ... 32	8	00 ... FFh	Data link encoding error flag
39			Master data
38			Primary slave byte 1
37			Primary slave byte 2
36			Primary slave byte 3
35			Primary slave byte 4
34			Primary slave byte 5
33			Secondary slave
32	Reserved for future use		
31 ... 0	32		Not used (arbitrary values)

7.3.2 Position Mode

In Position mode the time stamp is related to the position sampling edge of the “Vertical Position” (absolute position). The 128 bits of a log entry in Position mode are specified as follows:

Bit position	Width	Value range	Meaning
127 (MSB)	1	0	Escape bit
126 ... 104	23	00 00 00 ... 7F FF FFh	Time stamp (full resolution, 13.56 ns)
103 ... 96	8	00 ... FFh	Encoder error summary
95 ... 56	40	00 00 00 00 00 ... FF FF FF FF FFh	Vertical Position (absolute position, primary channel)
55 ... 40	16	00 00 ... FF FFh	Vertical Position CRC
39 ... 0	40	00 00 00 00 00 ... FF FF FF FF FFh	Accumulated Position (incremental position)

7.3.3 Message Mode

Please note that possibly unused fields in Message mode (e.g. data bytes or offset values) are unknown and are to be discarded. The 128 bits of a log entry in Message mode are specified as follows:

Bit position	Width	Value range	Meaning
127 (MSB)	1	0	Escape bit
126 ... 113	14	00 00 ... 3F FFh	Time stamp (reduced resolution, 6.94 μ s)
112	1	0 1	Messages source: Slave Messages source: Master
111 ... 96	16	00 00 ... FF FFh	Message address (remote register address or resource identifier)
95 ... 80	16	00 00 ... FF FFh	Message CRC
79 ... 64	16	00 00 ... FF FFh	Message offset value (only for Long Message)
63 ... 0	64	00 00 00 00 00 00 00 00 ... FF FF FF FF FF FF FF FFh	Data field of message (0, 2, 4, or 8 bytes)

Please note that in case of Short Message transfer, the Address field will contain both the address byte and the possible data byte. The lower 80 bits of the log entry are to be discarded.

PGT-09-S®**7.3.4 Events**

In all modes, events are stored as log entries. They are encoded as follows:

Time stamp counter overflow

After a time stamp counter overflow (every 100 ms), an overflow event is stored as a log entry. Its format is as follows:

Bit position	Width	Value range	Meaning
127 (MSB)	1	1	Event indicator
126 ... 104	23	00 00 00h	Time stamp reset value
103... 96	8	03h	Escape sequence: time stamp overflow
95 ... 0	96		Not used

Trigger

When the configured trigger conditions are met, a trigger event is stored as a log entry. Its format is as follows:

Bit position	Width	Value range	Meaning
127 (MSB)	1	1	Event indicator
126 ... 104	23	00 00 00 ... 7F FF FFh	Time stamp (full resolution, 13.56 ns)
103... 96	8	02h	Escape sequence: trigger
95 ... 0	96		Not used

Watch signals

When the configured watch signals change, a watch signal event is stored as a log entry. Its format is as follows:

Bit position	Width	Value range	Meaning
127 (MSB)	1	1	Event indicator
126 ... 104	23	00 00 00 ... 7F FF FFh	Time stamp (full resolution, 13.56 ns)
103... 96	8	01h	Escape sequence: watch signal
95 ... 32	64	00 00 00 00 00 00 00 00 ... FF FF FF FF FF FF FF FFh	Watched signals (see chapter 7.4)
31 ... 0	32		Not used

7.4 Protocol Signal Bits

For in-depth HIPERFACE DSL[®] link investigations, a set of protocol signals can be monitored by setting appropriate Watch Filters (see chapter 7.2.1). A protocol signal event is recorded if the signal bit changes. Some bits are grouped together into multi-bit words. For them an event is recorded if the record condition is met as indicated in the following table.

Bit position	Signal	Meaning	Record Condition
63 ... 56 (MSB)	summary(7:0)	Encoder error summary (see HIPERFACE DSL [®] Manual)	Treated as single bits
55 ... 52	mp_state(3:0)	Encoder Interface (DSL Master) protocol state machine	≤ watch value
51 ... 48	sp_state(3:0)	Encoder (DSL Slave) protocol state machine	≤ watch value
47	-	Reserved for future use	-
46 ... 40	err8b(6:0)	Master, Slave, and Slave 2 data link encoding errors (see chapter 7.3.1)	Treated as single bits
39	-	Reserved for future use	-
38	lockd	Encoder clock recovery state	Single bit
37	first	Drive sync signal indicator	Single bit
36	msync	Vertical frame start indicator	Single bit
35	aux	External trigger input state	Single bit
34	pos_not_valid	Position accumulator error	Single bit
33	acc_crc_error	Accumulated position CRC error	Single bit
32	vert_error	Vertical frame CRC error	Single bit
31	-	Reserved for future use	-
30	ms_msg_bad	Short message error (Encoder Interface -> Encoder)	Single bit
29	ms_lmsg_bad	Long message error (Encoder Interface -> Encoder)	Single bit
28 ... 24	m_par(4:0)	Message data (Encoder Interface -> Encoder)	≥ watch value
23	-	Reserved for future use	-
22	sm_msg_bad	Short message error (Encoder -> Encoder Interface)	Single bit
21	sm_lmsg_bad	Long message error (Encoder -> Encoder Interface)	Single bit
20 ... 16	s_par(4:0)	Message data (Encoder -> Encoder Interface)	≥ watch value
15	-	Reserved for future use	-
14 ... 12	ms_rssi(2:0)	Signal strength indicator (Encoder Interface -> Encoder)	< watch value
11 ... 8	sm_rssi(3:0)	Signal strength indicator (Encoder -> Encoder Interface)	< watch value
7 ... 4	-	Reserved for future use	-
3 ... 0	qm(3:0)	Quality monitor (see HIPERFACE DSL [®] Manual)	≤ watch value

8 Revision history

Revision	Change	Date	Author
0.10	Initial draft	2009-09-15	M. Rossello
0.20	First issue	2010-01-19	M. Rossello
0.30	Revision	2010-01-25	S. Stein
0.40	Corrected pinning, Watch filter explanation	2010-02-19	S. Stein
0.50	New Slave-Mode feature: Faulty DSL HFrame; Encoder Emulation revision: EG0 & EG1 setting;	2010-09-23	M. Rossello
0.60	Ch. 4.1: Addition of HDEB-mode Ch.3.5.2: Corrected figure (power supply not optional) Ch.3.5.3: Corrected figure (power supply not optional)	2012-12-12	C.Bitsch

Australia

Phone +61 3 9457 0600
1800 334 802 - tollfree
E-Mail sales@sick.com.au

Belgium/Luxembourg

Phone +32 (0)2 466 55 66
E-Mail info@sick.be

Brasil

Phone +55 11 3215-4900
E-Mail sac@sick.com.br

Canada

Phone +1(952) 941-6780
+1(800) 325-7425 - tollfree
E-Mail info@sickusa.com

Ceská Republika

Phone +420 2 57 91 18 50
E-Mail sick@sick.cz

China

Phone +86 4000 121 000
E-Mail info.china@sick.net.cn
Phone +852-2153 6300
E-Mail ghk@sick.com.hk

Danmark

Phone +45 45 82 64 00
E-Mail sick@sick.dk

Deutschland

Phone +49 211 5301-301
E-Mail kundenservice@sick.de

España

Phone +34 93 480 31 00
E-Mail info@sick.es

France

Phone +33 1 64 62 35 00
E-Mail info@sick.fr

Great Britain

Phone +44 (0)1727 831121
E-Mail info@sick.co.uk

India

Phone +91-22-4033 8333
E-Mail info@sick-india.com

Israel

Phone +972-4-6881000
E-Mail info@sick-sensors.com

Italia

Phone +39 02 27 43 41
E-Mail info@sick.it

Japan

Phone +81 (0)3 3358 1341
E-Mail support@sick.jp

Magyarország

Phone +36 1 371 2680
E-Mail office@sick.hu

Nederlands

Phone +31 (0)30 229 25 44
E-Mail info@sick.nl

Norge

Phone +47 67 81 50 00
E-Mail austefjord@sick.no

Österreich

Phone +43 (0)22 36 62 28 8-0
E-Mail office@sick.at

Polska

Phone +48 22 837 40 50
E-Mail info@sick.pl

România

Phone +40 356 171 120
E-Mail office@sick.ro

Russia

Phone +7-495-775-05-30
E-Mail info@sick.ru

Schweiz

Phone +41 41 619 29 39
E-Mail contact@sick.ch

Singapore

Phone +65 6744 3732
E-Mail admin@sicksgp.com.sg

Slovenija

Phone +386 (0)1-47 69 990
E-Mail office@sick.si

South Africa

Phone +27 11 472 3733
E-Mail info@sickautomation.co.za

South Korea

Phone +82 2 786 6321/4
E-Mail info@sickkorea.net

Suomi

Phone +358-9-25 15 800
E-Mail sick@sick.fi

Sverige

Phone +46 10 110 10 00
E-Mail info@sick.se

Taiwan

Phone +886 2 2375-6288
E-Mail sales@sick.com.tw

Türkiye

Phone +90 (216) 528 50 00
E-Mail info@sick.com.tr

United Arab Emirates

Phone +971 (0) 4 88 65 878
E-Mail info@sick.ae

USA/México

Phone +1(952) 941-6780
1 (800) 325-7425 - tollfree
E-Mail info@sickusa.com

More representatives and agencies
at www.sick.com