



TFinity Library

Site Preparation Guide



SPECTRALOGIC.COM

Copyright

Copyright © 2009 – 2015 Spectra Logic Corporation. All rights reserved. This item and the information contained herein are the property of Spectra Logic Corporation.

Notices

Except as expressly stated herein, Spectra Logic Corporation makes its products and associated documentation on an “AS IS” BASIS, WITHOUT WARRANTY OF ANY KIND, EITHER EXPRESSED OR IMPLIED, INCLUDING BUT NOT LIMITED TO THE IMPLIED WARRANTIES OF MERCHANTABILITY OR FITNESS FOR A PARTICULAR PURPOSE, BOTH OF WHICH ARE EXPRESSLY DISCLAIMED. In no event shall Spectra Logic be liable for any loss of profits, loss of business, loss of use or data, interruption of business, or for indirect, special, incidental or consequential damages of any kind, even if Spectra Logic has been advised of the possibility of such damages arising from any defect or error. Information furnished in this manual is believed to be accurate and reliable. However, no responsibility is assumed by Spectra Logic for its use. Due to continuing research and development, Spectra Logic may revise this publication from time to time without notice, and reserves the right to change any product specification at any time without notice.

Trademarks

BlueScale, CC, Spectra, SpectraGuard, Spectra Logic, TeraPack, and TranScale are registered trademarks of Spectra Logic Corporation. ArchiveGrade, BlackPearl, IntraCloud, nTier Verde, and Verde are trademarks of Spectra Logic Corporation. All rights reserved worldwide. All other trademarks and registered trademarks are the property of their respective owners.

Part Number

90940047 Revision D

Revision History

Revision	Date	Description
A	November 2009	Initial release.
B	June 2010	Updated regulatory information added LTO-5
C	January 2013	Updated for corrections and added bulk TAP.
D	March 2015	Updated trademarks.

- Notes:**
- To make sure you have the most current version of this guide check the Spectra Logic Technical Support portal at: support.spectralogic.com/documentation/user-guides/.
 - To make sure you have the release notes for the most current version of the BlueScale software, check the Spectra Logic Technical Support portal at: support.spectralogic.com/documentation/release-notes/.

License

You have acquired a Spectra TFinity Library that includes software owned or licensed by Spectra Logic from one or more software licensors (“Software Suppliers”). Such software products, as well as associated media, printed materials and “online” or electronic documentation (“SOFTWARE”) are protected by copyright laws and international copyright treaties, as well as other intellectual property laws and treaties.

If you do not agree to this end user license agreement (EULA), do not use the Spectra Product; instead, promptly contact Spectra Logic for instructions on return of the Spectra Product for a refund. Any use of the Software, including but not limited to use on the Spectra Product, will constitute your agreement to this EULA (or ratification of any previous consent).

Grant of License. The Software is licensed on a non-exclusive basis, not sold. This EULA grants you the following rights to the Software:

- You may use the Software only on the Spectra Product.
- **Not Fault Tolerant.** The Software is not fault tolerant. Spectra Logic has independently determined how to use the Software in the Spectra Product, and suppliers have relied upon Spectra Logic to conduct sufficient testing to determine that the Software is suitable for such use.
- **No Warranties for the SOFTWARE.** The Software is provided “AS IS” and with all faults. The entire risk as to satisfactory quality, performance, accuracy, and effort (including lack of negligence) is with you. Also, there is no warranty against interference with your enjoyment of the Software or against infringement. If you have received any warranties regarding the SOFTWARE, those warranties do not originate from, and are not binding on Software suppliers.
- **Note on Java Support.** The Software may contain support for programs written in Java. Java technology is not fault tolerant and is not designed, manufactured, or intended for use of resale as online control equipment in hazardous environments requiring fail-safe performance, such as in the operation of nuclear facilities, aircraft navigation or communications systems, air traffic control, direct life support machines, or weapons systems, in which the failure of Java technology could lead directly to death, personal injury, or severe physical or environmental damage.
- **No Liability for Certain Damages.** Except as prohibited by law, Software suppliers shall have no liability for any indirect, special, consequential or incidental damages arising from or in connection with the use or performance of the Software. This limitation shall apply even if any remedy fails of its essential purpose. In no event shall Software suppliers, individually, be liable for any amount in excess of U.S. two hundred fifty dollars (U.S. \$250.00).
- **Limitations on Reverse Engineering, Decompilation, and Disassembly.** You may not reverse engineer, decompile, or disassemble the Software, except and only to the extent that such activity is expressly permitted by applicable law notwithstanding this limitation.
- **Software Transfer Allowed with Restrictions.** You may permanently transfer rights under this EULA only as part of a permanent sale or transfer of the Spectra nTier700, and only if the recipient agrees to this EULA. If the Software is an upgrade, any transfer must also include all prior versions of the Software.
- **Export Restrictions.** Export of the Software from the United States is regulated by the Export Administration Regulations (EAR, 15 CFR 730-744) of the U.S. Commerce Department, Bureau of Export Administration. You agree to comply with the EAR in the export or re-export of the Software: (i) to any country to which the U.S. has embargoed or restricted the export of goods or services, which as May 1999 include, but are not necessarily limited to Cuba, Iran, Iraq, Libya, North Korea, Sudan, Syria, and the Federal Republic of Yugoslavia (including Serbia, but not Montenegro), or to any national or any such country, wherever located, who intends to transit or transport the Software back to such country; (ii) to any person or entity who you know or have reason to know will utilize the Software or portion thereof in the design, development or production of nuclear, chemical, or biological weapons; or (iii) to any person or entity who has been prohibited from participating in U.S. export transactions by any federal agency of the U.S. government. You warrant and represent that neither the BXA nor any other U.S. federal agency has suspended, revoked or denied your export privileges.

Warnings

A document listing all warnings found in Spectra Tape Libraries documentation, in English and 27 other languages, is available on the Spectra Logic website at support.spectralogic.com/documentation.



WARNING

Library frames are very heavy (see product specifications for details). Use extreme caution and proper equipment when moving these, and ensure that your floor has adequate structural integrity.



WARNING

Line voltage exists at these connectors.

Only qualified personnel should attempt to conduct this test.

Use extreme caution when taking measurements.



WARNING

Boxed and unboxed library components weigh from 200 to 400 pounds each (91 to 181 kg) or more. Use extreme caution and proper equipment when moving these.



WARNING

The ties around the shipping crates are secured very tightly; the tension may cause them to whip outward when cut. Use care when cutting the ties so that you will not be hit.

Contacting Spectra Logic

To Obtain General Information

Spectra Logic Website: www.spectralogic.com

United States Headquarters

Spectra Logic Corporation
6285 Lookout Road
Boulder, CO 80301
USA

Phone: 1.800.833.1132 or 1.303.449.6400

International: 1.303.449.6400

Fax: 1.303.939.8844

European Office

Spectra Logic Europe Ltd.
Venture House
Arlington Square, Downshire Way
Bracknell, RG12 1WA
United Kingdom

Phone: 44 (0) 870.112.2150

Fax: 44 (0) 870.112.2175

Spectra Logic Technical Support

Technical Support Portal: support.spectralogic.com

United States and Canada

Phone:

Toll free US and Canada: 1.800.227.4637

International: 1.303.449.0160

Europe, Middle East, Africa

Phone: 44 (0) 870.112.2185

Deutsch Sprechende Kunden

Phone: 49 (0) 6028.9796.507

Email: spectralogic@stortrec.de

Mexico, Central and South America, Asia, Australia, and New Zealand

Phone: 1.303.449.0160

Spectra Logic Sales

Website: www.spectralogic.com/shop

United States and Canada

Phone: 1.800.833.1132 or 1.303.449.6400

Fax: 1.303.939.8844

Email: sales@spectralogic.com

Europe

Phone: 44 (0) 870.112.2150

Fax: 44 (0) 870.112.2175

Email: eurosales@spectralogic.com

To Obtain Documentation

Spectra Logic Website: support.spectralogic.com/documentation/

Contents

About This Guide	7
INTENDED AUDIENCE	7
RELATED INFORMATION	7
Chapter 1 – Library Overview	11
FRONT PANEL COMPONENTS	12
MAIN AND DRIVE EXPANSION FRAME REAR COMPONENTS	13
MEDIA EXPANSION FRAMES	14
SERVICE FRAME REAR PANEL COMPONENTS	14
BULK TAP SERVICE FRAME FRONT PANEL COMPONENTS	15
LIBRARY CAPACITY	15
Chapter 2 – Site Requirements	17
PHYSICAL REQUIREMENTS	17
Data Center Flooring	17
Space Requirements	20
Power Requirements	23
NETWORK CABLING REQUIREMENTS	28
ENVIRONMENTAL REQUIREMENTS	30
Chapter 3 – Preparing for Installation	32
RECEIVING AND STORING THE LIBRARY	33
Acclimating the Library	33
UNPACKING AND MOVING THE LIBRARY	34
Structural Integrity of Flooring	34
Required Equipment	34
Clearances	35
Tilting	35
MOVING THE LIBRARY AFTER INSTALLATION	36
Site Preparation Checklist	37

ABOUT THIS GUIDE

This guide describes site preparation requirements and guidelines for the installation of a Spectra® TFinity library. It includes precautions for safety and handling, as well as facility requirements for the library's environment, cabling, and placement. This guide also provides a checklist that you can use to help ensure that your site is prepared before your library arrives.

INTENDED AUDIENCE

This guide is intended for data center administrators preparing a site for a TFinity library installation. It provides reference information for facility managers, electricians, IT professionals and other specialists who will have roles in preparing the site.

RELATED INFORMATION

The following sections contain information about additional TFinity-related documentation that is available.

Spectra TFinity Library

This guide and the following documents related to the Spectra TFinity are available as PDF files on the Spectra Logic website at: support.spectrallogic.com/documentation.

- The *Spectra TFinity Library User Guide* describes how to configure, use, maintain, and troubleshoot the Spectra TFinity library. It also provides specifications for the library.
- The *Spectra TFinity Library Quick Reference Guide* provides a quick reference for the user interface and instructions for performing day-to-day library operations such as powering on and off, and preparing, importing, and exporting media.
- The *Spectra TFinity Library BlueScale Toolbar Option Map* provides a quick reference for locating the options and commands available through the BlueScale user interface.
- The *Spectra BlueScale Vision Camera User Guide* provides detailed information about installing and using the white BlueScale Vision Camera and software.
- The *Vivotek FD8361 Fixed Dome Network Camera User's Manual* provides detailed information about installing and using the black BlueScale Vision Camera and software.
- The *Spectra Encryption User Guide* provides detailed information about using BlueScale Encryption Standard and Professional Edition and the Spectra TKLM Encryption key management system. It also provides useful information about encryption best practices and recycling encrypted media.
- The *Spectra Tape Libraries SCSI Developer's Guide* provides detailed information about the SCSI and Fibre Channel commands used in the library.
- The *Spectra Tape Libraries XML Command Reference* provides detailed information about using the XML interface with the TFinity library.
- The *Spectra Tape Libraries Warnings* document provides all of the warnings found in Spectra tape libraries documentation, in English and 27 other languages.

The following document is available after logging into your Support portal account at: support.spectrallogic.com.

- The *Spectra TFinity Library Release Notes and Documentation Updates* provides the most up-to-date information about the TFinity, drives, and media.

LTO Ultrium Tape Drives

The following documents provide information that is applicable to all IBM LTO tape drives.

- *IBM Tape Device Drivers Installation and User's Guide*
Note: This guide also provides information about using the IBM Tape Diagnostic Tool (ITDT) to troubleshoot drive problems.
- *IBM TotalStorage LTO Ultrium Tape Drive: SCSI Reference* (LTO-1 through LTO-4)
- *IBM TotalStorage LTO Ultrium Tape Drive: SCSI Reference* (LTO-5 and LTO-6)

For drive-specific information, search for the product name (for example, LTO 5) on the documentation page on the IBM website. You can also search the IBM Support Portal at:

<http://www-947.ibm.com/support/entry/portal/Documentation>.

TS11x0 Technology Drives

The following documents provide information that is applicable to TS11x0 technology drives.

- *IBM System Storage Tape Drive 3592 SCSI Reference*
- *IBM Tape Device Drivers Installation and User's Guide*
Note: This guide also provides information about using the IBM Tape Diagnostic Tool (ITDT) to troubleshoot drive problems.

Spectra TKLM Server

For additional information that can assist you during the installation and configuration of your server, see the following websites:

- *IBM Tivoli Key Lifecycle Manager Information Center*
- *Tivoli Key Lifecycle Manager Installation and Configuration Guide*

Typographical Conventions

This document uses the following conventions to highlight important information:

Note: Read text marked with “Note” for additional information or suggestions about the current topic.



Important

Read text marked by the “Important” icon for information that will help you complete a procedure or avoid extra steps.



Caution

Read text marked by the “Caution” icon for information you must know to avoid damaging the library, the tape drives, or losing data.



WARNING

Read text marked by the “Warning” icon for information you must know to avoid personal injury.

This document uses an arrow (→) to describe a series of menu selections. For example:

Select **Configuration** → **Partitions** → **New**.

— means —

Select **Configuration**, then select **Partitions**, and then select **New**.

CHAPTER 1

Library Overview

The Spectra TFinity enterprise-class library is designed and built to meet the stringent requirements for data integrity, data security and high reliability in the enterprise environment. The following sections provide an overview of the library components. Depending on the options you ordered, some of the components shown may not be included in your library. For detailed descriptions of the library components and media, read the Library Overview chapter in the *Spectra TFinity Library User Guide*.

Note: The library will be installed by a certified Spectra Logic field engineer. The information in the following sections is provided for your reference only. This document is not an installation guide.

Topic	
Front Panel Components	page 12
Main and Drive Expansion Frame Rear Components	page 13
Service Frame Rear Panel Components	page 14
Library Capacity	page 15

FRONT PANEL COMPONENTS

Figure 1 shows the front components of the library. It also shows the relative locations of the main frame, the expansion frames, and the service frames.

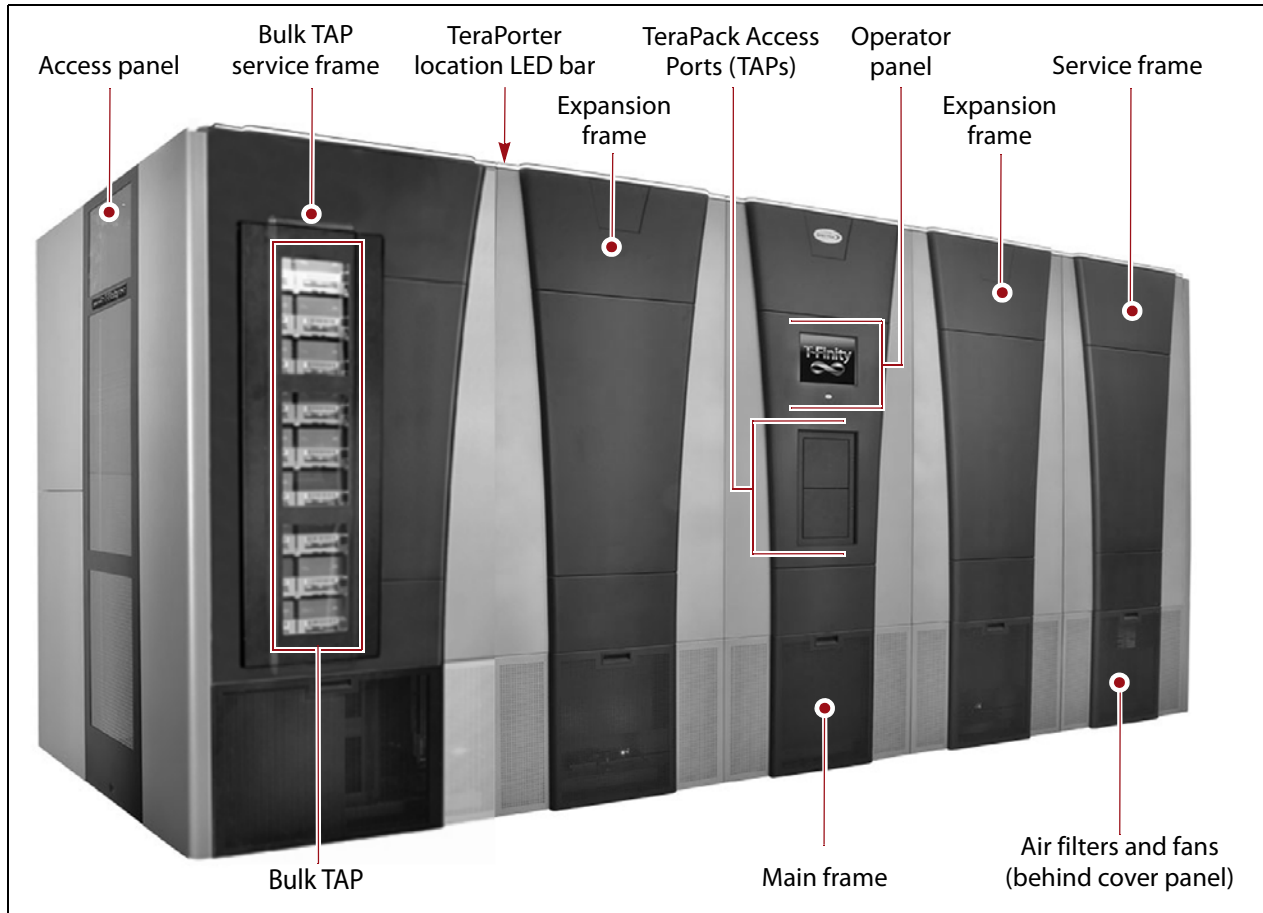

Figure 1 Front panel components.

MAIN AND DRIVE EXPANSION FRAME REAR COMPONENTS

Figure 2 shows the rear panel components of the library’s main frame. With few exceptions, the same components are also present in each drive expansion frame.

Note: Any bays that do not contain components have covers installed to ensure proper air circulation through the library.

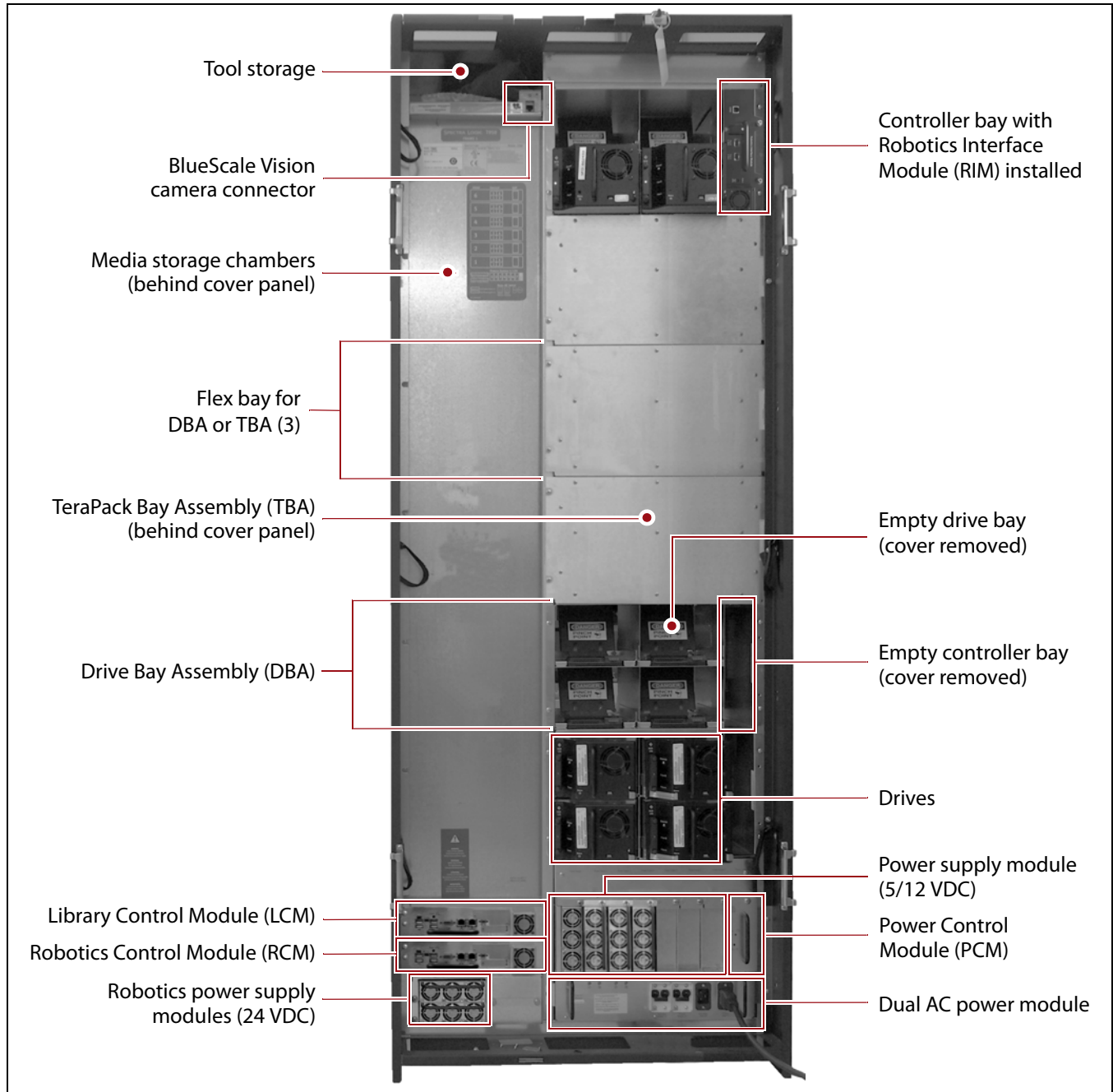

Figure 2 Library main frame rear components (doors removed).

MEDIA EXPANSION FRAMES

Media expansion frames are for media storage only and do not include any active front or rear panel components.

SERVICE FRAME REAR PANEL COMPONENTS

The library includes two service frames, one for each TeraPorter. The service frame is the last frame on each end of the library. [Figure 3](#) shows the components of the service frame.

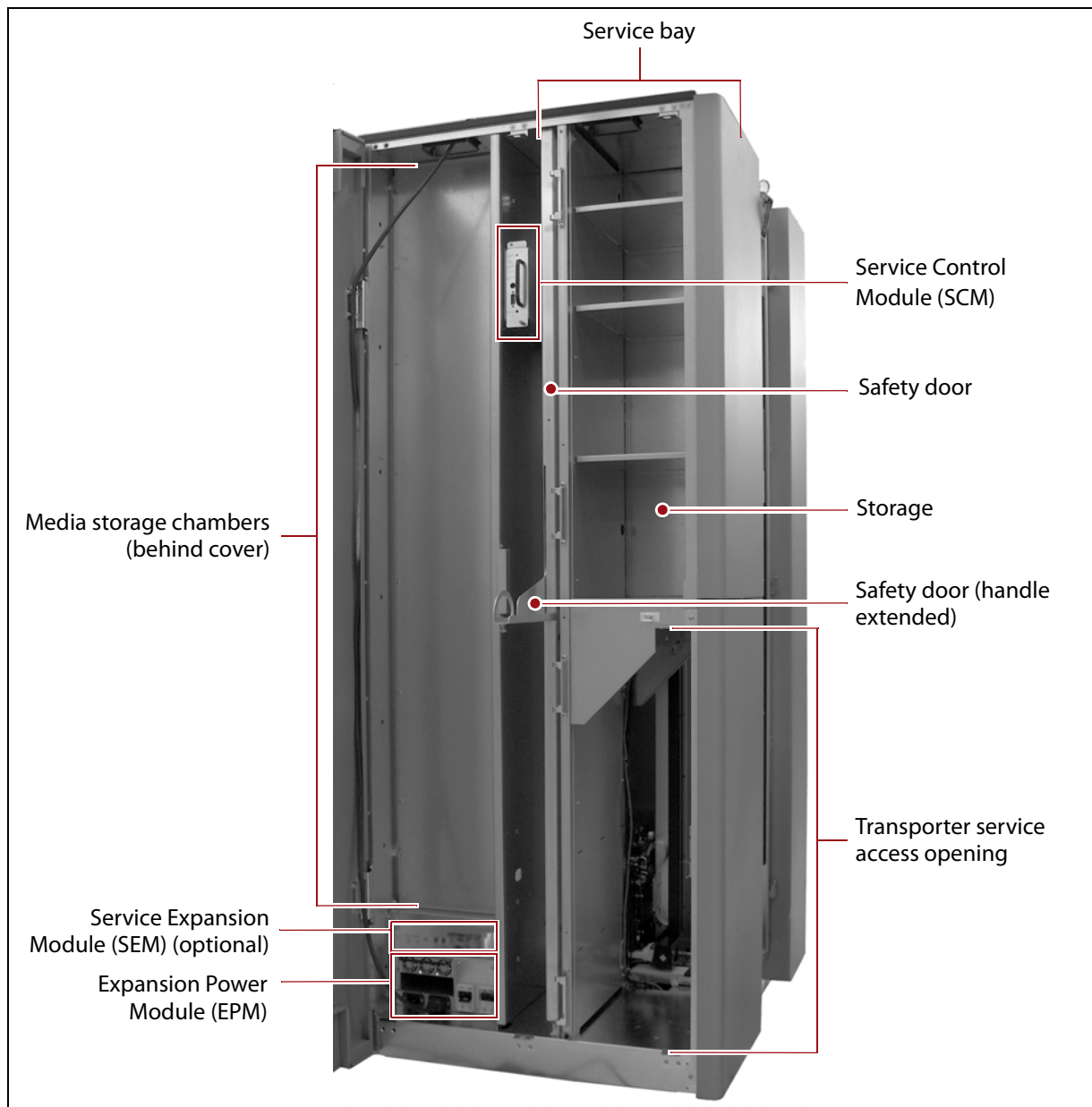

Figure 3 Service frame components (back-side of left-hand service frame shown).

BULK TAP SERVICE FRAME FRONT PANEL COMPONENTS

The bulk TeraPack Access Port (bulk TAP) service frame can replace the left or right service frame. It includes the components of the standard service frame (see [Service Frame Rear Panel Components on page 14](#)) and a bulk TAP carousel used to import or export up to 14 magazines in a single operation.

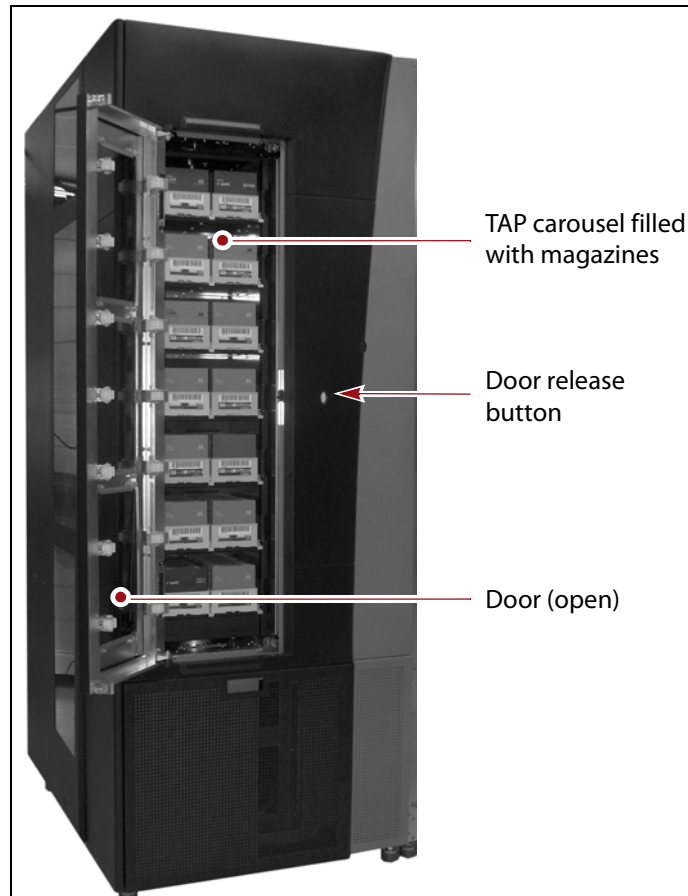

Figure 4 The front of the bulk TAP media frame.

LIBRARY CAPACITY

The TFinity's modular design makes it possible to increase media capacity or the number of drives in the library to meet storage and performance needs as they evolve. The minimum configuration TFinity consists of three frames: the main frame and two service frames. A mix of media and drive expansion frames can be added for a maximum total of 40 frames. The frames are positioned to provide the most efficient configuration based on the site requirements. The service frames or bulk TAP service frames are always located at the outside ends of the library.

The following table shows the number of media storage chambers and drives in each type of frame in the TFinity.

Frame Type	Description	Number of Chambers for LTO Frame ^a	Number of Chambers for TS11x0 Technology Frame ^{b, c}	Number of Drives
Main ^d	Contains: <ul style="list-style-type: none"> the operator panel the center TAP assembly with two chambers the LCM an RCM RIMs An EtherLib switch (optional) power supplies drives in either three or six DBAs chambers for magazine storage 	<ul style="list-style-type: none"> 92 chambers with 3 DBAs and 3 TBAs —OR— 80 chambers with 6 DBAs 	<ul style="list-style-type: none"> 66 chambers with 6 DBAs 	<ul style="list-style-type: none"> From 1 to 12 LTO drives with 3 DBAs and 3 TBAs —OR— From 1 to 24 LTO or TS11x0 technology drives with 6 DBAs
Drive expansion	Contains: <ul style="list-style-type: none"> an RCM RIMs power supplies drives in either three or six DBAs chambers for magazine storage 	<ul style="list-style-type: none"> 101 chambers with 3 DBAs and 3 TBAs —OR— 89 chambers with 6 DBAs 	<ul style="list-style-type: none"> 75 chambers with 6 DBAs 	<ul style="list-style-type: none"> From 1 to 12 LTO drives with 3 DBAs and 3 TBAs —OR— From 1 to 24 LTO or TS11x0 technology drives with 6 DBAs
Media expansion	Contains: <ul style="list-style-type: none"> chambers for magazine storage 	<ul style="list-style-type: none"> 130 chambers 	<ul style="list-style-type: none"> 110 chambers 	None
Service or bulk TAP service ^e	Contains: <ul style="list-style-type: none"> a service bay for TeraPorter maintenance power supplies an SCM an SEM (optional) chambers for magazine storage 	<ul style="list-style-type: none"> 50 chambers 	<ul style="list-style-type: none"> 42 chambers 	None

a. A single magazine is stored in each chamber. Each magazine contains 10 slots for LTO cartridges.

b. A single magazine is stored in each chamber. Each magazine contains nine slots for TS11x0 technology cartridges.

c. TS11x0 technology frames are not available in a 3 DBA and 3 TBA configuration.

d. The TAP cannot be used for magazine storage.

e. The bulk TAP service frame also includes a bulk TAP carousel with 14 chambers. The TAP carousel cannot be used for magazine storage.

CHAPTER 2

Site Requirements

This chapter describes the site requirements for the library. Make sure that the location where the library will be installed meets these requirements before the field engineer arrives to install the library.

Topic	
Physical Requirements	this page
Data Center Flooring	this page
Space Requirements	page 20
Power Requirements	page 23
Network Cabling Requirements	page 28
Environmental Requirements	page 30

PHYSICAL REQUIREMENTS

The following physical requirements apply to the location where the library will be installed. Meeting these requirements sets the necessary parameters for successfully operating the library, as well as ensuring adequate clearances for, maintenance access to, and expansion of the library.

Data Center Flooring

The flooring where you plan to install the library is an important part of the installation and operation planning. Make sure that it has adequate structural integrity to handle the weight and leveling requirements of the library.



WARNING

Library frames are very heavy (see product specifications for details). Use extreme caution and proper equipment when moving these, and ensure that your floor has adequate structural integrity.

Library Weight The following table shows the size and weight specifications for the library frames and other components.

- Notes:**
- All dimensions and weights are approximate.
 - To calculate the approximate weight of a loaded library, calculate the total weight for all of the frames and then add the weight for each drive, RIM, and power supply, plus the weight of each TeraPack magazine full of cartridges.
 - When calculating space requirements, include the service access requirements described in [Space Requirements on page 20](#).

Parameter	Specification			
	Main Frame	Drive Expansion Frame	Media Expansion Frame	Service Frame
Height ^a	79.125 to 82 in. (201.0 to 208.3 cm)			
Width	29 in. (73.7 cm)			29.8 in. (75.7 cm)
Depth ^b	43.25 in. (109.9 cm)			
Weight ^{c, d}	6D0T: 821 lb (372 kg) 3D3T: 810 lb (367 kg)	6D0T: 763 lb (346 kg) 3D3T: 750 lb (340 kg)	564 lb (256 kg)	Standard: 737 lb (334 kg) Bulk TAP: 824 lb (374 kg)
Each drive (with drive sled)	<ul style="list-style-type: none"> ▪ LTO-4: 11.5 lb (5.2 kg) ▪ LTO-5 and LTO-6: 11.6 lb (5.3 kg) ▪ TS11x0 technology: 17.5 lb (8 kg) 		N/A	N/A
Each TeraPack magazine	<ul style="list-style-type: none"> ▪ with ten LTO cartridges: 5.1 lb (2.3 kg) ▪ with nine TS11x0 technology cartridges: 5.6 lb (2.5 kg) 			
Each RIM	5 lb (2.3 kg)		N/A	N/A
Each power supply	4 lb (1.8 kg)		N/A	4 lb (1.8 kg)

a. The height of each frame can be adjusted to allow frame-to-frame leveling on uneven floors.

b. This dimension is for the frame with the front and back cover panels installed.

c. These weights are with no RIMs, drives, or media installed.

d. 6D0T means six Drive Bay Assemblies and zero TeraPack Bay Assemblies. 3D3T means three Drive Bay Assemblies and three TeraPack Bay Assemblies.

The following table shows the fully loaded maximum weight of each frame type.

Frame Type ^a	Maximum Weight for LTO Frame	Maximum Weight for TS11x0 Technology Frame
6D0T Main Frame	1574 lb (714 kg)	1641 lb (744 kg)
3D3T Main Frame	1461 lb (663 kg)	NA
6D0T Drive Frame	1561 lb (708 kg)	1627 lb (738 kg)
3D3T Drive Frame	1447 lb (656 kg)	NA
Media Frame	1227 lb (557 kg)	1180 lb (535 kg)
Service Frame	1000 lb (454 kg)	980 lb (445 kg)
Bulk TAP Service Frame	1087 lb (493 kg)	1067 lb (484 kg)

a. 6D0T means six Drive Bay Assemblies and zero TeraPack Bay Assemblies. 3D3T means three Drive Bay Assemblies and three TeraPack Bay Assemblies.

Data center floors may require reinforcement to hold the library's weight. Check your site's flooring for load-bearing specifications.



Caution

Spectra Logic is not responsible for damage caused to the library or its surroundings if the floor is not adequately reinforced. Inadequate floor reinforcement can allow the library to sag, causing misalignment of the frames and robotic motion failures.

Weight-Distribution Plate If you would like to install the library on a weight-distributing plate, Spectra Logic recommends a steel plate with the minimum dimensions of 36 x 30 x 0.25 inches (91.4 x 76.2 x 0.6 cm). Plates should be placed under the feet at the front and back of each frame junction and under the outer feet of the right-most and left-most frames of a multi-frame library.

Note: After determining the positions for the plates, attach them to the floor to prevent them from moving as you roll the frames into place.

Flooring Type The floor where the library is to be installed must be level, and must be hard flooring, such as cement or tile — do not install the library on carpeting. This requirement is particularly important when installing a multi-frame library, because all frames must be precisely aligned. Carpeting also increases the risk of static discharge when operating the library.



Caution

The library must be installed on a level, hard-surfaced floor such as cement or tile.

A small amount of floor unevenness can be compensated for using the levelers on each library frame.

Space Requirements

The base TFinity library consists of a main frame and two service frames. It can be expanded by adding multiple additional frames. The service frames must always be the left-most and right-most frames.

Important A minimum of 2 feet (0.6 m) of clearance is required on the ends of the library to provide access to the service frames. If data center equipment is on rolling racks and can be easily moved to provide the clearance on each end of the library, then having equipment adjacent to the ends of the library is acceptable. In addition, a minimum of 2 feet (0.6 m) of clearance at the front and back of the main frame, each drive expansion frame, and each service frame is required for airflow and accessibility. Providing 3 feet (0.9 m) of clearance on all sides of the library is highly recommended.

Important The service frames, regular or bulk TAP, must be at the two ends of the library; the other frames can be placed in any order. Discuss the actual layout with your Spectra Logic Professional Services representative.

For example, [Figure 5](#) shows the total space required for an eight frame library, including the recommended access clearance.

Note: All dimensions are rounded to the nearest tenth.

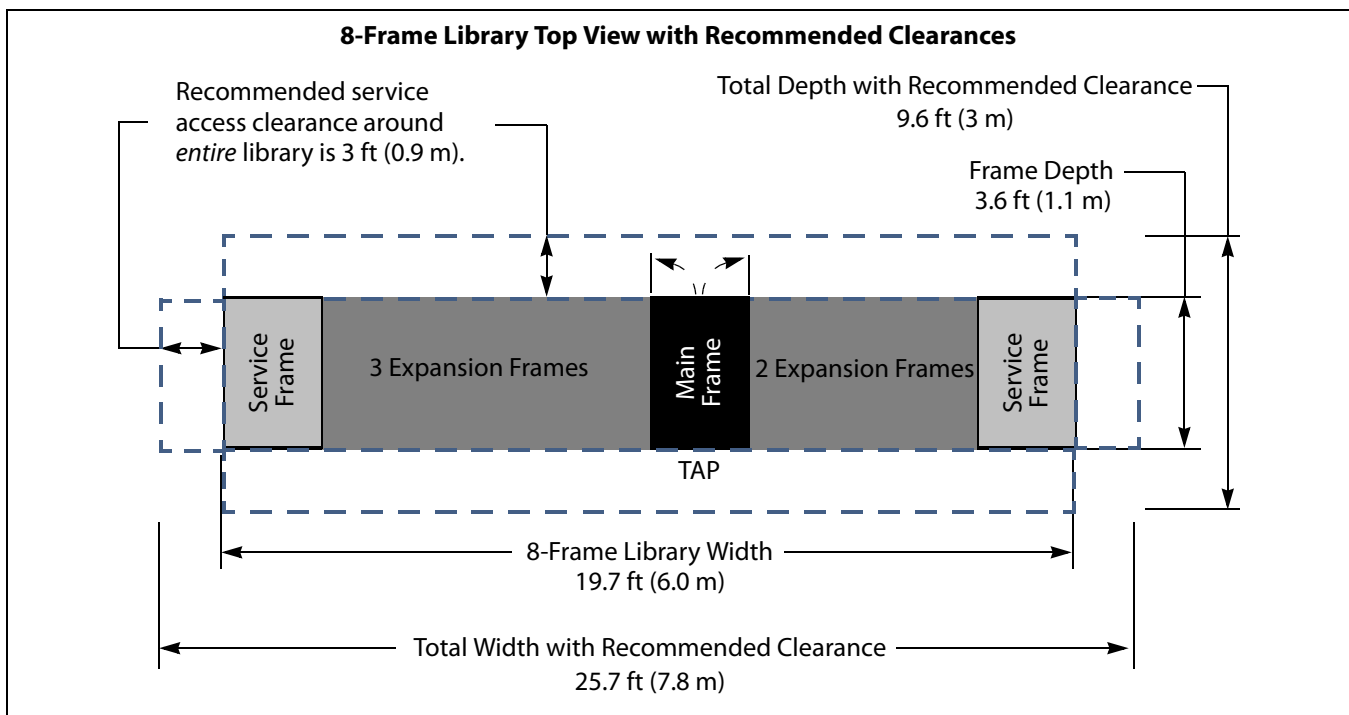

Figure 5 Dimensions of an eight-frame TFinity, including recommended service access.

Service Access Requirements

Minimum Access Requirements A minimum of 2 feet (0.6 m) of clearance is required on the left and right ends of the library to provide service access to the service frames. If data center equipment is on rolling racks and can be easily moved to provide the clearance on each end of the library, then having equipment adjacent to the ends of the library is acceptable. In addition, a minimum of 2 feet (0.6 m) of clearance at the front and back of the main frame, each drive expansion frame, and each service frame is required for airflow and service and operator access.

Recommended Access Requirements Providing 3 feet (0.9 m) of clearance on all sides of the library is highly recommended. The depth for the library main frame, each drive expansion frame, and each service frame plus the 3 feet (0.9 m) of recommended access space front and back is 9.6 feet (2.93 m). The following table shows the width requirements for multi-frame libraries plus the 3 feet (0.9 m) of recommended access space on each side of the library. For libraries greater than ten frames, add 2.6 ft (0.8 m) for each additional frame.

Number of Frames ^a	Library Width	Width with Recommended Service Access
Three Frames	91 in. (231.0 cm)	163 in. (414.0 cm)
Four Frames	120 in. (305.0 cm)	192 in. (487.7 cm)
Five Frames	149 in. (378.5 cm)	221 in. (561.3 cm)
Six Frames	178 in. (452.1 cm)	250 in. (635.0 cm)
Seven Frames	207 in. (529.8 cm)	279 in. (708.7 cm)
Eight Frames	236 in. (599.4 cm)	308 in. (782.3 cm)
Nine Frames	265 in. (673.1 cm)	337 in. (856.0 cm)
Ten Frames	294 in. (746.8 cm)	366 in. (929.6 cm)

a. All dimensions are rounded to the nearest tenth.

Floor and Ceiling Cable Access

Figure 6 through Figure 8 on page 23 provide the dimensions for cable access holes for main, drive expansion, and service frames. See Figure 10 on page 28 to see the location of these access holes in a frame. The dimensions are different for the floor and ceiling access holes. Be sure to consider the structural integrity of the floor before cutting holes in the floor for access.



WARNING

Library frames are very heavy (see product specifications for details). Use extreme caution and proper equipment when moving these, and ensure that your floor has adequate structural integrity.

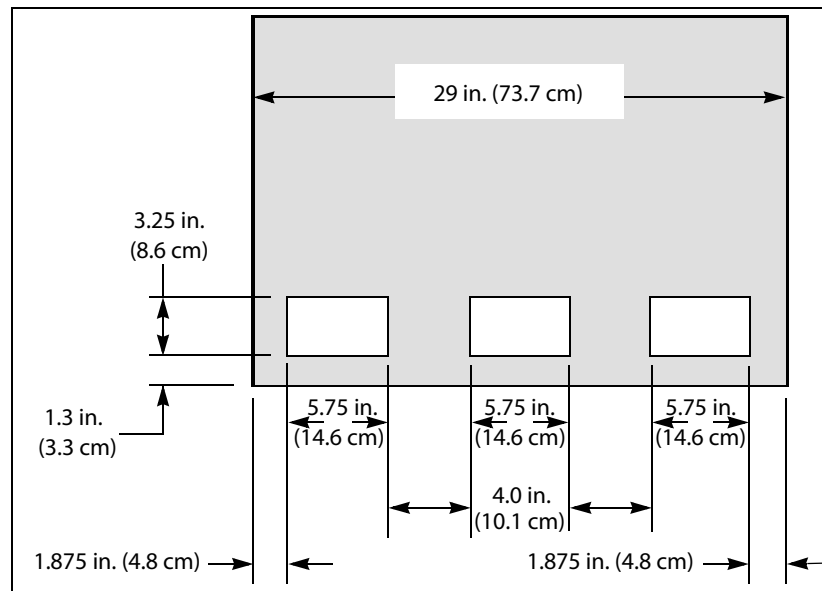

Figure 6 Ceiling cable access for main and drive expansion frames.

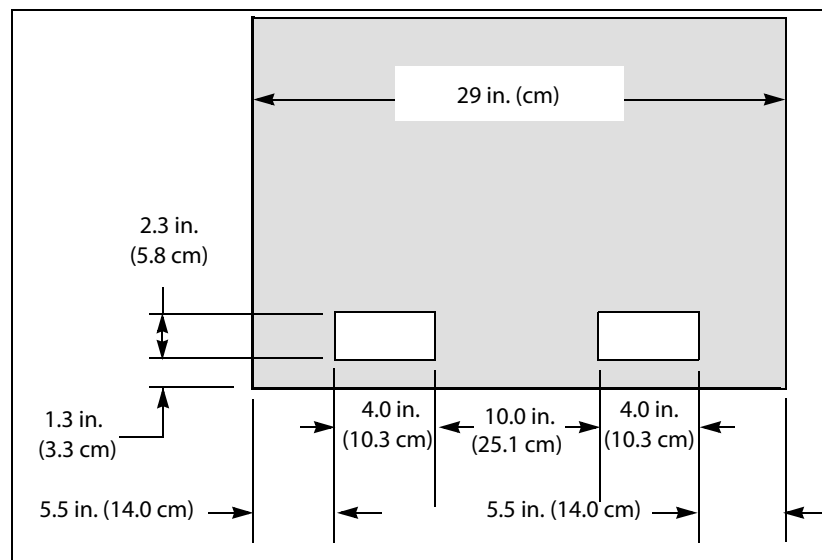

Figure 7 Ceiling cable access for service frames.

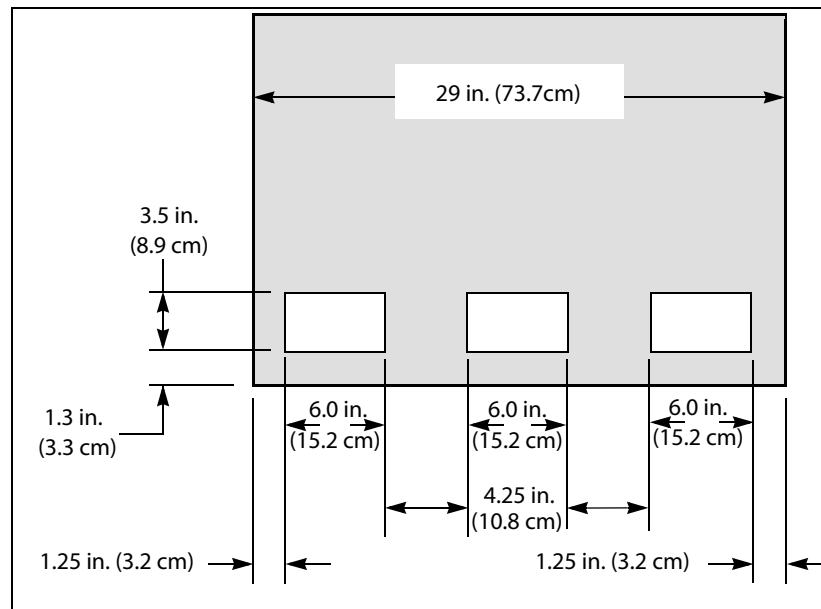

Figure 8 Floor cable access for main, drive expansion, and service frames.

Power Requirements

This section provides an overview of the power requirements for the library. All electrical cabling must be completed *before* beginning the library installation.



Caution

Failure to meet the cabling and power specifications could damage your library, result in data loss, or both.

Power Input The main frame, the drive expansion frames, and the service frames include dual AC power inputs. When using a redundant power configuration, connect each input to a separate branch circuit, which supports failover in the event of a power failure in one of the circuits.

To prevent problems switching between two AC power sources in a redundant AC power configuration, make sure each frame's AC inputs are both on the same phase. Different frames can be on different phases.



Caution

If the power sources for the dual AC inputs for a frame are not on the same phase, damage to the library could result.

Also, the voltages of the two AC power sources must be the same within a few volts. To ensure that this requirement is being met, measure the voltages between the pins of the two input cables (IEC 60320-C19).



WARNING

Line voltage exists at these connectors.

Only qualified personnel should attempt to conduct this test.

Use extreme caution when taking measurements.

The two top pins are voltage inputs. The bottom pin is ground. As shown in [Figure 9](#), the top input voltage pins are labeled A and B, from left to right, and the bottom pins are labeled C. Confirm the following measurements:

- The voltage from A to A or B to B should be less than 4 V.
- The voltage from A to B or B to A should be between 200 and 240 V.
- The voltage between any A or B pin to either C pin should be about 120 V.

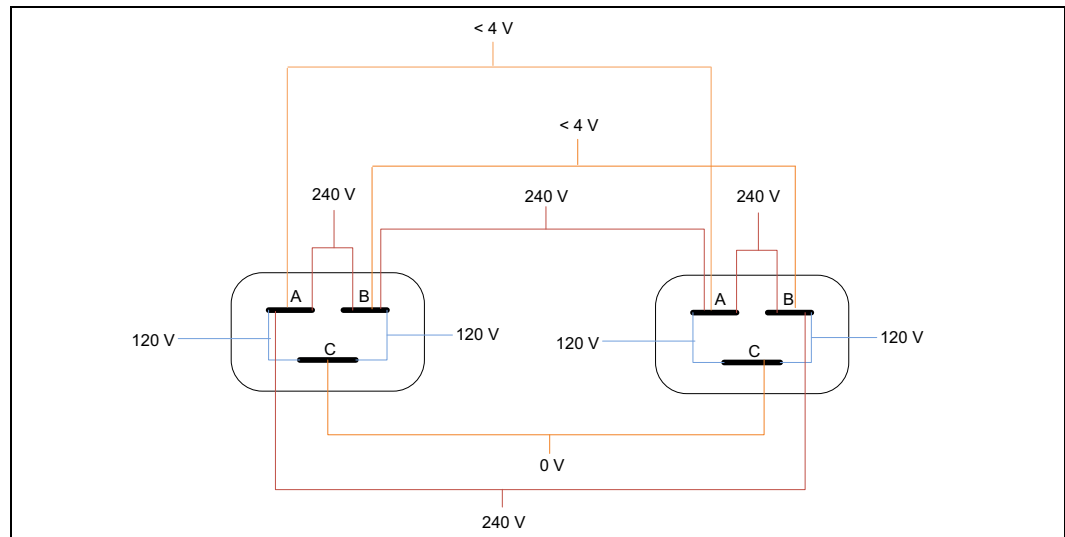

Figure 9 Dual AC input voltage requirements.

Each library frame is rated at 200–240 VAC at 13 amps (2600 watts maximum). This power rating is based on a main frame with 24 LTO drives and 6 RIMs, which is the configuration for maximum power consumption by a single frame. The frames are *not* rated at 120 VAC due to the high current required to supply the product.

Due to electromagnetic interference (EMI) filtering in each dual AC power supply, the leakage current for main frames and drive frames is such that they require a secure connection from the chassis of the unit to an earth ground.

Use one or more of the following methods for securing a ground connection when installing a main frame or drive frame:

- Notes:**
- Cord lock brackets and cords with locking connectors are not compatible and cannot be used simultaneously.
 - Expansion Frame Power Modules do not require locking cords or special grounding.
 - Add cord lock brackets (Spectra Logic part number 5497) to all drive frames. See “Installing Cord Locks” in the *Spectra TFinity Library User Guide* for more information.
 - Use a cord with locking connectors at both ends, such as L6 20P to locking C19 (Spectra Logic part number 9594).
 - Use a dedicated external ground wire (Spectra Logic part number 91017013) from the chassis screw lug to the building’s earth ground.

Power Cord Specifications The power cords included with the library are considered part of the library and are not intended for use with any other equipment. The power cord must meet the specifications for the country where the library will be installed.



North America and Korea 200–240 VAC Power Cord The criteria for a 200-volt to 240-volt AC power cord in North America and Korea are as follows:

Parameter	Specification
Power cordage	SJT type, three-conductor, 14 AWG minimum
Power input connectors	<ul style="list-style-type: none"> ▪ Male: Connector must be of the proper type, rating, and safety approval (see Supply-End Connector Types on page 26). ▪ Female: IEC 60320 C13

International 200–240 VAC Power Cord The criteria for an international 200-volt to 240-volt AC power cord are as follows:

Parameter	Specification
Power cordage	Flexible, HAR (harmonized) type H05VV-F, three conductor, cord with minimum conductor size of 1.7 square millimeters (0.0026350 square inches).
Power input connectors	<ul style="list-style-type: none"> ▪ Male: Connector must be of the proper type, rating, and safety approval for the intended country (see Supply-End Connector Types on page 26). ▪ Female: IEC 60320 C13

Supply-End Connector Types The supply-end connector on the cord depends on the country where the library will be installed. The following table shows the supply-end connector types used in some countries.

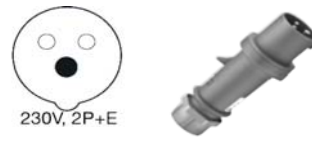
Part Number	Country of Use	Plug Style	Length	Appearance
5500	North America, Korea	NEMA L6-20P	14.8 ft (4.5 m)	
7029	North America, Korea	NEMA L6-30P	14.8 ft (4.5 m)	
6807	Japan	NEMA L6-20P	13.9 ft (4.25 m)	
8665	United Kingdom, Continental Europe	IEC 60309	15 ft (4.6 m)	

Power Outlet Location The twist lock supply-end connector is considered the power disconnect for the unit. The outlet must therefore be installed in an accessible location near the library.

Power Receptacles The power receptacles for the main frame, the drive expansion frames, and the service frames are located in the lower right-hand corner of the frame as you face the back of the library.

The following table shows the number of power outlets for each frame type.

Frame Type	Number of Power Outlets
Main Frame	2
Drive Expansion Frame	2
Media Expansion Frame	0
Service or Bulk TAP Service Frame	2

Power Consumption and Cooling Requirements The power and cooling requirements for the library depend on the number and type of drives installed. The following table provides the maximum power consumption and heat load for the base library and for each additional component added to the base library. Use this information to calculate the total maximum power consumption and heat load values, which can be used to build a power budget for the library.

All values are measured at the AC input and include power supply efficiency. The values are averages of observed hardware. In general, the lighter the load on the power supplies, the less efficient they are. The power supply efficiency in turn affects the power draw of all components.

Component	Power Consumption (watts)	Heat Load, Continuous (BTU/hour)
Minimum Library (3-frame) ^a	613	2093
Drive frame ^b	153	522
Media frame	30	102
Bulk TAP frame	21	72
5/12 VDC power supply	33	113
24 VDC power supply	29	99
RIM	12	41
LTO-6 Fibre Channel	<ul style="list-style-type: none"> ▪ Read/write: 28 ▪ Idle: 8 ^c 	Read/write: 95
LTO-5, Fibre Channel	<ul style="list-style-type: none"> ▪ Read/write: 37 ▪ Idle: 19 ^c 	Read/write: 126
LTO-4, Fibre Channel	<ul style="list-style-type: none"> ▪ Read/write: 37 ▪ Idle: 17.5 ^c 	Read/write: 123
TS1150 technology	<ul style="list-style-type: none"> ▪ Read/write: 55 ▪ Idle: 38 ^b 	Read/write: 188
TS1140 technology	<ul style="list-style-type: none"> ▪ Read/write: 53 ▪ Idle: 30 ^b 	Read/write: 181

a. Includes two 24 VDC and two 5/12 VDC power supplies in the main frame, and two service frames each with two 24 VDC power supplies; no drives or RIMs installed.

b. Includes one 24 VDC power supply; no drives or RIMs installed.

c. No cartridge loaded.

NETWORK CABLING REQUIREMENTS

The library can accommodate cabling from either the bottom or the top of the library. See [Floor and Ceiling Cable Access](#) on page 22 for additional information.

Use [Figure 10](#) and the descriptions that follow to plan network connectivity for the library installation.

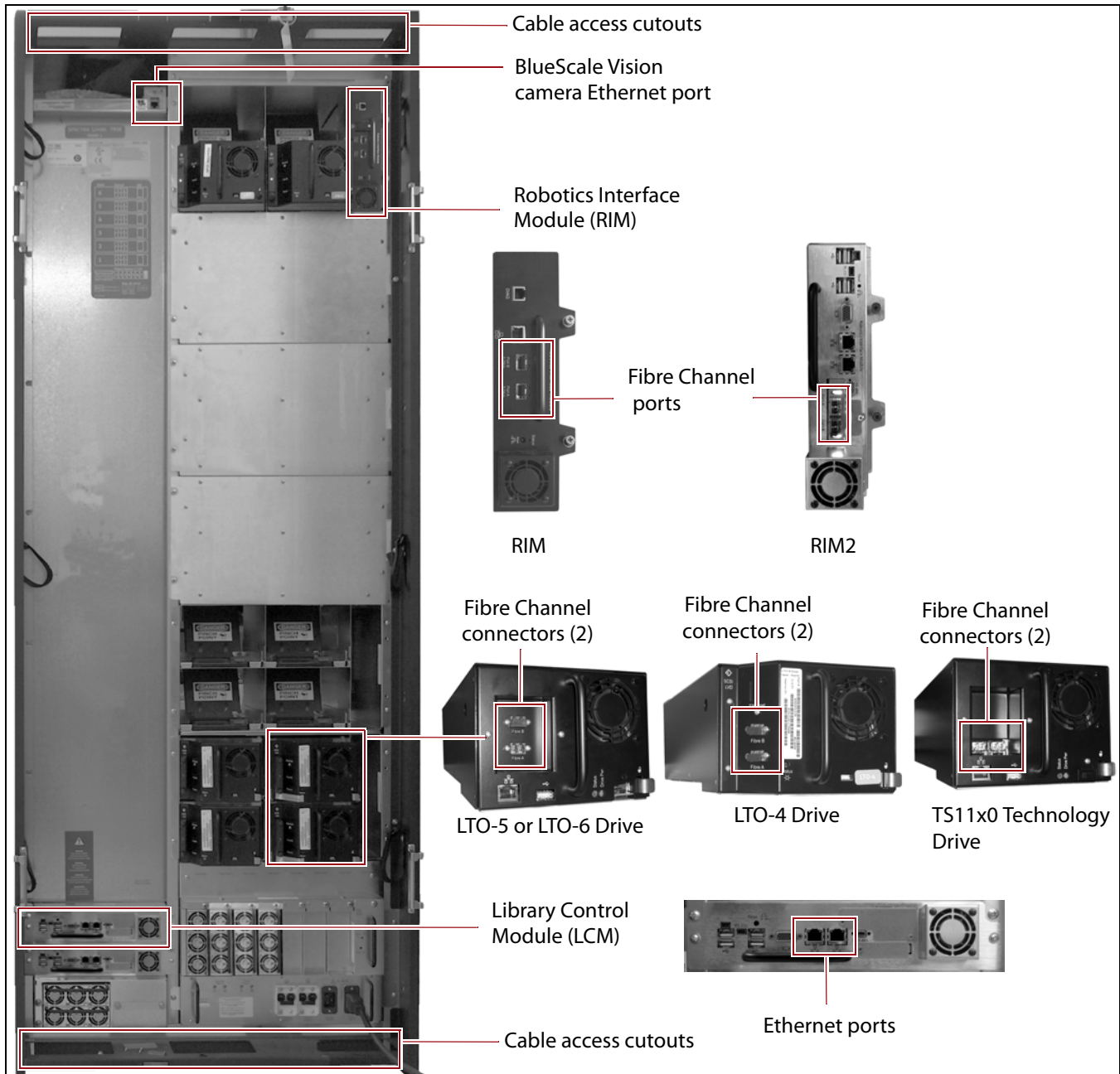

Figure 10 Locations for network cable connections.

Library Access Provide a Category 5 (10/100BaseT connection) data-grade Ethernet cable that is compliant with EIA/TIA 568 from an active Ethernet network to be connected to an Ethernet port on the LCM to support remote access to the library's BlueScale web interface and to allow the library to automatically email notifications to users and AutoSupport tickets to Spectra Logic Technical Support. During installation, the library's connection is set up with the library's IP address, subnet, proxy server, and other IP configuration settings.



Caution Some port scanning software can interfere with remote library sessions.

Host Access Provide one or two optical fiber cables from the arbitrated loop or switched fabric, to Fibre Channel port(s) on a RIM in each partition to provide the hosts with access to the partitions. Depending on the wavelength, the cables must comply with the following specifications in the Fibre Channel standard (FC-PI-2):

- **50-micron**—400-M5-SN-I classification
- **62.5 micron**—400-M6-SN-I classification

Tape Drive Access Provide one optical fiber cable from the arbitrated loop or switched fabric, to a Fibre Channel port on each drive, to provide the hosts with access to the partitions. Depending on the wavelength, the cables must comply with the following specifications in the Fibre Channel standard (FC-PI-2):

- **50-micron**—400-M5-SN-I classification
- **62.5 micron**—400-M6-SN-I classification (not supported for LTO-6 or TS11x0 technology drives)

The following table can be used to determine the maximum length for an M5 cable.

Data Rate / Link Speed	M5 (OM2) cable	M5E (OM3) cable	M5F (OM4) cable
1 Gbps	1640 ft (500 m)	Not Specified	Not Specified
2 Gbps	984 ft (300 m)	Not Specified	Not Specified
4 Gbps	492 ft (150 m)	1247 ft (380 m)	1312 ft (400 m)
8 Gbps	164 ft (50 m)	492 ft (150 m)	623 ft (190 m)

BlueScale Vision Camera Access One BlueScale Vision camera is included with the main frame. Additional cameras can be installed in the expansion frames. To comply with EMC requirements, provide a shielded Category 5 (10/100BaseT connection) data-grade cable or a similar Category 5 cable from an active Ethernet network to each camera.

ENVIRONMENTAL REQUIREMENTS

The following sections list the general environmental specifications for the library.

Air Flow Air flows through the library from front to back. In data centers using a hot aisle/cold aisle layout, position the library so that the cold aisle is in front of the library (cold air in), and the hot aisle is behind the library (hot air out).

Air Quality Keep the location as free of airborne particulates as possible. To eliminate obvious sources of particulates, do not permit anyone to smoke, eat, or drink near the storage area, and do not place the library near a copier or printer that may emit toner and paper dust.

Temperature, Humidity, and Altitude The library is equipped with internal fans that operate as much as is necessary for the number of DBAs installed. The fans keep the library's internal temperature within specifications as long as the data center environment is within specifications. The following table outlines the necessary data center and storage area specifications.

Operating Environmental Specification	
Humidity	20% to 80% (non-condensing)
Humidity gradient	Less than 10% per hour
Ambient temperature	LTO: 50° F to 90° F (10° C to 32° C) TS11x0 Technology: 61° F to 90° F (16° C to 32° C)
Maximum temperature change rate ^a	18° F per hour (10° C per hour), non-condensing
Maximum wet bulb temperature	77° F (25° C)
Altitude	Sea level to 10,000 ft (3,048 m)

a. The temperature and humidity must be allowed to stabilize in the specified ambient environment for 24 hours.

Storing ^a and Shipping (Non-Operating) Environment Specification	
Humidity	10% to 95% (non-condensing)
Temperature	-40° F to 149° F (-40° C to 65° C)
Altitude	Sea level to 40,000 ft (12,192 m)

a. The library is in its original packaging. The packaging is designed to protect the library from condensation caused by extreme temperature variations of 27° F (15° C) or more. When the library is moved from a cold storage environment to a warm operating environment, it must be acclimated in its packaging for at least 24 hours before opening to prevent serious condensation damage from occurring.

Fire Protection To comply with the OSHA Directive for Fixed Extinguishing Systems (General, 1910.160), the library has a punch-out in the cover for each frame and a corresponding cut-out in the top of each frame for the purpose of attaching a hose or nozzle from your site's fixed extinguishing system.

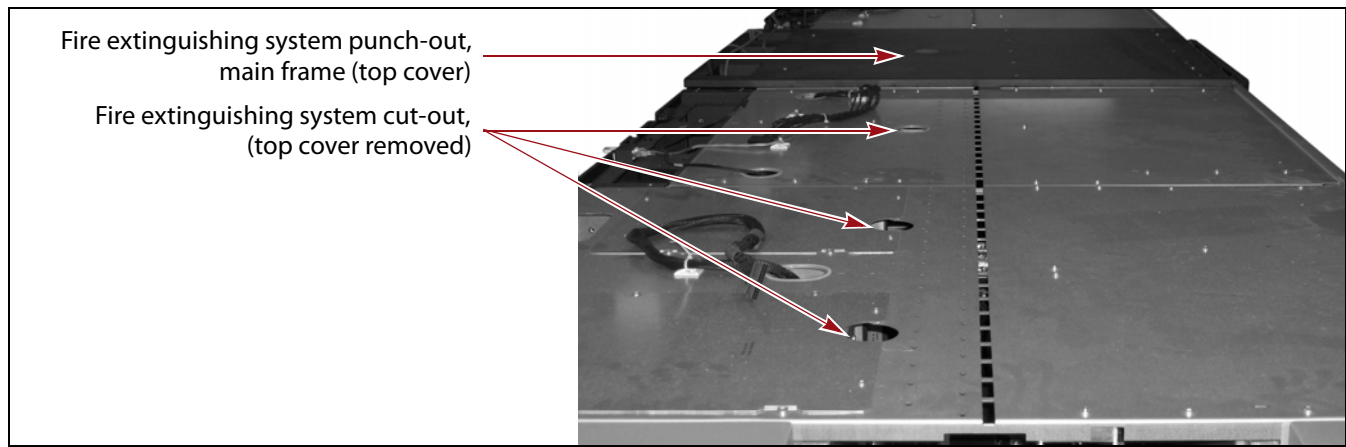

Figure 11 Location of the fire extinguishing system access opening in top of library.

Shock and Vibration The library will operate normally after experiencing shock loads as specified in the following table. The operating shock levels indicate how much shock the library can withstand while the enclosed drives are reading and writing data. The non-operating and storage shock levels indicate how much shock the library can withstand when it is not operating. After experiencing this amount of shock, the library will operate normally.

Specification	Operating	Storing and Shipping (Non-Operating Environment) ^a
Shock	2 g pk ½ sine wave for 10 msec (3 axes, 2 shocks per axis, minimum)	2 g pk ½ sine wave for 10 msec (3 axes, 2 shocks per axis, minimum)
Vibration (Swept Sine)	5 Hz – 500 Hz – 5 Hz 5 – 22 Hz, 0.01-inch DA displacement 22 – 500 Hz, 0.25G pk @ ½ octave (minimum three axes)	5 Hz – 500 Hz – 5 Hz 5 – 31 Hz, 0.02-inch DA displacement 31 – 500 Hz, 1G pk @ ½ octave (minimum three axes)
Vibration (Random)	0.5 Grms, 0 – 3000 Hz (single axis)	1 – 200 Hz @ 1.156 Grms. Bottom face only for 60 minutes.

a. Specifications are for the library in its original packaging.

CHAPTER 3

Preparing for Installation

The library will be installed by a certified Spectra Logic field engineer. This chapter outlines the requirements for storing and moving the library and its components. Make sure that you review these requirements carefully. The information is provided to ensure that the installation site meets the necessary requirements *before* the Spectra Logic field representative arrives.

Topic	
Receiving and Storing the Library	page 33
Unpacking and Moving the Library	page 34
Moving the Library After Installation	page 36



WARNING

Library frames are very heavy (see product specifications for details). Use extreme caution and proper equipment when moving these, and ensure that your floor has adequate structural integrity.



WARNING

Boxed and unboxed library components weigh from 200 to 400 pounds each (91 to 181 kg) or more. Use extreme caution and proper equipment when moving these.



WARNING

The ties around the shipping crates are secured very tightly; the tension may cause them to whip outward when cut. Use care when cutting the ties so that you will not be hit.

RECEIVING AND STORING THE LIBRARY

Before the library arrives, make sure that your receiving and storage areas can accommodate the pallet and boxes used to ship the library and its components. The library is shipped in multiple boxes: one for each library frame and others for the library components such as drives, controllers (RIMs), TeraPack magazines, and media. The boxes are shipped on pallets. The following table provides the approximate dimensions and weights of the pallet and boxes used to ship the library.

	Height	Width	Depth	Weight
Crated Frame ^a	7.2 ft (2.2 m)	3.5 ft (1.1 m)	4.6 ft (1.4 m)	1,200 to 1,300 lb ^b (544 to 590 kg)
Crated TeraPorter ^c	6.8 ft (2.1 m)	2.6 ft (0.8 m)	2.1 ft (0.6 m)	200 lb (91 kg)
Component Pallet ^{d, e}	1.8 to 5 ft (0.6 to 1.5 m)	3.5 to 14.9 ft (1.1 to 4.6 m)	1.8 to 5 ft (0.6 to 1.5 m)	200 to 400 lb (91 to 181 kg)

a. Each frame is shipped in a separate crate. The accessory box might ship with the main frame.

b. The weight does not include drives, media, RIMs, TeraPorter, or power supply modules.

c. Each TeraPorter ships in a separate crate.

d. Assumes multiple components are shipped together on a single pallet. Components may also be shipped individually.

e. The size and weight of the component pallet depends on the number and type of components shipped. To calculate the approximate weight of all the components, add 12 lb (5.4 kg) for each drive, 5 lb (2.3 kg) for each TeraPack magazine full of media, 5 lb (2.3 kg) for each RIM, and 4 lb (1.8 kg) for each power supply.

In preparation for the installation, locate the accessory box, which may have shipped and arrived separately from the library. This box contains option activation keys, the library documentation kit, and additional information that you should read before the library is installed. Make sure that you do not lose any of the option activation keys.

Acclimating the Library

Allow time for the library to acclimate to the working environment when you move it from the loading dock.



Caution

When the library is moved from a cold storage environment to a warm operating environment, it must be acclimated in its packaging for at least 24 hours before opening to prevent serious condensation damage from occurring.

UNPACKING AND MOVING THE LIBRARY

The following sections describe the requirements to safely unpack and maneuver library and component crates from storage to their operating location.

**Caution**

Keep all library and components crated while moving them to the data center. If the data center is not able to accommodate the crates, contact Spectra Logic Professional Services in advance of the installation date. See [Contacting Spectra Logic on page 5](#).

Structural Integrity of Flooring

Ensure that all floors that will be traversed can withstand the weights of the crated components shown in [Receiving and Storing the Library on page 33](#).

Required Equipment

Ensure that any equipment used to move the library components can transport the weights shown in [Receiving and Storing the Library on page 33](#).

Level Surfaces A pallet jack or forklift is required to move the crates on a level surface.

Stairways A stair crawler or other special equipment must be used to traverse stairways. A ramp can sometimes be used to traverse one or two stairs.

Clearances

Before moving the library and components to where they will be installed, make sure that you have access to necessary doorways, stairways, hallways, and elevators, as well as adequate clearance to move through them with the equipment.

Note: All lengths are approximate.

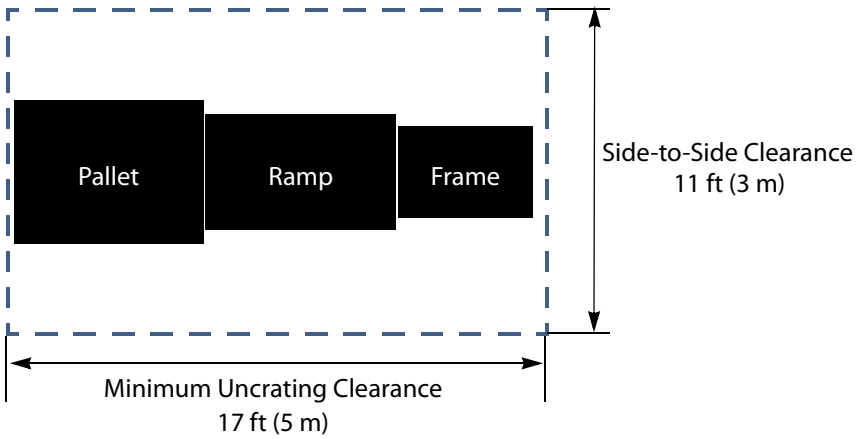
Clearance for...	Requirement
Unpacking	<p>Sufficient space to both remove the library from its packaging and unpack the boxes containing the additional components.</p>  <ul style="list-style-type: none"> ▪ Allow a minimum of approximately 17 feet (5 m) on the ramp side of the pallet to unload the library and approximately 4 feet (1.2 m) on each side and above the crate to remove the packaging. ▪ Allow a minimum of 12 feet by 12 feet (3.6 m by 3.6 m) of open space for maneuvering the individual frames from their crates.
Doorways	Doorways (including thresholds) must be taller than 6.7 feet (2 m) and wider than 4 feet (1.2 m).
Stairwell width and height	Stairwells must be taller than 7.5 feet (2.3 m) and wider than 4 feet (1.2 m).
Stairwell and hallway corners	Stairway and hallway corners should be wider than 5.6 feet (1.7 m).
Elevator width and height	Elevators and elevator doors should be taller than 7.5 feet (2.3 m) and wider than 4 feet (1.2 m). If using an elevator to move the crates, it must be able to accommodate the length of the crate containing each TeraPorter.

Tilting

Make sure that you do not tilt the frames from vertical while moving them.



Caution

If you tilt the library, Spectra Logic is not responsible for any damage caused to the library or its components, or for any damage caused to your site.

MOVING THE LIBRARY AFTER INSTALLATION

The library hardware is configured to ensure proper thermal control, air flow, and dust filtering. After the library is installed, do not move the library.



Important

Moving the library without assistance from a Spectra Certified field engineer will void your service contract. Contact Spectra Logic Professional Services for assistance if you need to relocate your library (see [Contacting Spectra Logic on page 5](#)).

Contact Spectra Logic Technical Support before making any changes to your library hardware or performing any service operations.

Site Preparation Checklist

Use this checklist to ensure that all of the requirements have been met prior to delivery of your library.

Site Requirements	
Data Center Flooring on page 17	
<input type="checkbox"/>	Flooring is hard (not carpeted) and capable of supporting the weight of the library.
<input type="checkbox"/>	Weight distribution plates have been installed (optional).
<input type="checkbox"/>	Flooring is level.
Space Requirements on page 20	
<input type="checkbox"/>	Space is available for the library's height, width, and depth.
<input type="checkbox"/>	Space is available for service and operator access.
<input type="checkbox"/>	Space is available for future growth (optional).
<input type="checkbox"/>	Cables can be routed to the library's cable access areas.
Power Requirements on page 23	
<input type="checkbox"/>	Electrical and peripheral equipment cabling is complete and organized.
<input type="checkbox"/>	Proper number and type of outlets are available at the required locations.
<input type="checkbox"/>	Electrical circuits meet power consumption requirements.
<input type="checkbox"/>	Two separate branch circuits are available to allow for failover in the event of a power failure in one of the circuits (optional).
Network Cabling Requirements on page 28	
<input type="checkbox"/>	Cabling for remote access to the library's BlueScale web interface is complete and organized.
<input type="checkbox"/>	Cabling for host access to the library is complete and organized.
<input type="checkbox"/>	Cabling for host access to the tape drives is complete and organized.
<input type="checkbox"/>	Cabling for access to the BlueScale Vision Camera(s) is complete and organized.

Environmental Requirements on page 30	
<input type="checkbox"/>	Airflow and air quality meet the library's specifications.
<input type="checkbox"/>	Temperature and humidity are within the library's specifications.
<input type="checkbox"/>	Fire suppression equipment is in place.
<input type="checkbox"/>	Vibration and shock will not exceed the library's specifications.
Preparing for Installation	
Receiving and Storing the Library on page 33	
<input type="checkbox"/>	The receiving/storage area can handle the size and weight of each crated library frame as well as the crate of library components.
<input type="checkbox"/>	The delivery and installation schedule allows 24 hours for the library to acclimate before installation.
Unpacking and Moving the Library on page 34	
<input type="checkbox"/>	Floors to be traversed can handle the weight of the crated frames.
<input type="checkbox"/>	Transportation equipment—forklift, pallet jack, and/or stair crawler—is available and can handle the weight of the crated frames.
<input type="checkbox"/>	Doorways, stairwells, hallways, and elevators allow the size of the crated library without tilting.
<input type="checkbox"/>	Elevators can handle the weight of the crated library.
<input type="checkbox"/>	Space is available in the data center where the library is to be installed for the crates and crate ramp, with extra space for maneuvering.
<input type="checkbox"/>	If the path, transportation equipment, or data center is not able to accommodate the crates, contact Spectra Logic Professional Services in advance of the installation date. See Contacting Spectra Logic on page 5 .