



VVDED399062US R5/00  
May 2000  
Raleigh, NC, USA

## Instruction Bulletin

# ALTIVAR<sup>®</sup> 28 Adjustable Speed Drive Controllers User's Guide

Retain for future use.



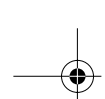

## **⚠ DANGER**

### **HAZARDOUS VOLTAGE**

- Read and understand this bulletin in its entirety before installing or operating ALTIVAR 28 drive controllers. Installation, adjustment, repair, and maintenance of the drive controllers must be performed by qualified personnel.
- Disconnect all power including external control power that may be present before servicing the drive controller. **WAIT TEN MINUTES** for the DC bus capacitors to discharge. Then follow the DC bus voltage measurement procedure on page 16 to verify that the DC voltage is less than 45 V. The drive controller LEDs are not accurate indicators of the absence of DC bus voltage.
- **DO NOT** short across DC bus capacitors or touch unshielded components or terminal strip screw connections with voltage present.
- Install and close all covers before applying power or starting and stopping the drive controller.
- User is responsible for conforming to all applicable code requirements with respect to grounding all equipment.
- Many parts in this drive controller, including printed wiring boards, operate at line voltage. **DO NOT TOUCH.** Use only electrically insulated tools.

Before servicing the drive controller:

- Disconnect all power.
- Place a "DO NOT TURN ON" label on the drive controller disconnect.
- Lock disconnect in open position.

**Electrical shock will result in death or serious injury.**

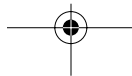
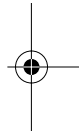
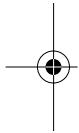

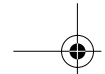

INTRODUCTION .....	1
REVISION LEVEL .....	1
RECEIVING AND PRELIMINARY INSPECTION .....	1
STORING AND SHIPPING .....	2
TECHNICAL CHARACTERISTICS .....	2
SPECIFICATIONS .....	4
DIMENSIONS AND WEIGHTS .....	5
INSTALLATION .....	6
Precautions .....	6
Mounting and Temperature Conditions .....	7
Labels .....	8
Mounting in Type 12 (or IP54) Metal Enclosure .....	9
Calculating Enclosure Size .....	9
Ventilation .....	11
ELECTROMAGNETIC COMPATIBILITY .....	12
Installation Precautions for Meeting EN55011 Class A .....	12
EMC PLATE .....	14
WIRING .....	15
Bus Voltage Measurement Procedure .....	16
General Wiring Practices .....	17
Branch Circuit Connections .....	18
Output Wiring Precautions .....	18
Grounding .....	19
Power Terminals .....	21
Control Terminals .....	23
Wiring Diagram .....	24
RECOMMENDED FUSES .....	25
AVAILABLE TORQUE .....	26
BASIC DRIVE CONTROLLER FUNCTIONS .....	27
Fault Relay, Reset .....	27
Drive Controller Thermal Protection .....	27
Drive Controller Ventilation .....	27
Motor Thermal Protection .....	28
CONFIGURABLE LOGIC AND ANALOG I/O FUNCTIONS .....	29
Logic Input Functions .....	29
Direction Of Operation: Forward / Reverse .....	29
2-Wire Control .....	29

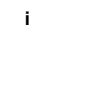
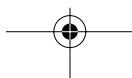
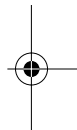

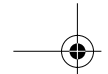

3-Wire Control . . . . .	29
Ramp Switching . . . . .	29
Jog . . . . .	29
Preset Speeds . . . . .	30
Speed Reference Switching . . . . .	30
Freewheel Stop . . . . .	30
DC Injection Stop . . . . .	30
Fast Stop . . . . .	30
Fault Reset . . . . .	31
Forced Local Mode When Using The Serial Link . . . . .	31
Analog Input Functions . . . . .	31
Reference summing with AI1 . . . . .	31
PI Feedback . . . . .	31
Auto/Manual Operation with PI . . . . .	32
R2 Relay Functions . . . . .	32
Analog Output (AO) Functions . . . . .	32
Function Compatibility . . . . .	33
<b>PROGRAMMING AND SET-UP . . . . .</b>	<b>34</b>
Preliminary Recommendations . . . . .	34
Factory Settings . . . . .	35
Using the Keypad Display . . . . .	36
Access to Menus . . . . .	37
Access to Parameters . . . . .	38
<b>PROGRAMMING CODES . . . . .</b>	<b>39</b>
Adjust Menu . . . . .	39
Drive Menu . . . . .	42
I/O Menu . . . . .	46
Display Menu . . . . .	50
<b>CONFIGURATION TABLES . . . . .</b>	<b>52</b>
Menu (Settings) . . . . .	52
Menu (Inputs/Outputs) . . . . .	52
Menu (Drive) . . . . .	53
<b>MAINTENANCE AND TROUBLESHOOTING . . . . .</b>	<b>54</b>
Precautions . . . . .	54
Procedure 2: Checking the Peripheral Equipment . . . . .	55
<b>EQUIPMENT DAMAGE HAZARD . . . . .</b>	<b>55</b>
<b>FAULT STORAGE . . . . .</b>	<b>56</b>

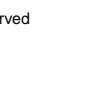
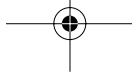
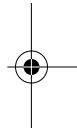
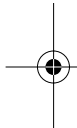

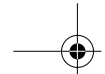

**Bulletin No. VVDED399062US R5/00**  
**May 2000**

**ALTIVAR® 28 User's Manual**  
**Contents**

---

FAULT CODES .....	56
Drive Controller Does Not Start, No Fault Displayed .....	57
OPTIONS .....	58
Start/Stop/Potentiometer Kit—VW3A28100 .....	58
Remote Display Mounting Option—VW3A28101 .....	59
Conduit Entry Kit .....	60
DIN Rail Kit—VW3A28851 .....	60
PC Software Kit—VW3A8106 .....	60
MODBUS® Kit—VW3A28301U .....	61
ATV18 Replacement Kit .....	61

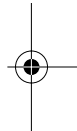

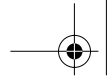

**ALTIVAR® 28 User's Manual  
Contents**

**Bulletin No. VVDED399062US R5/00  
May 2000**

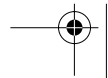
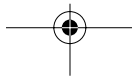
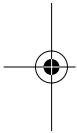

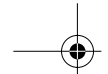

## INTRODUCTION

The ALTIVAR 28 family of adjustable frequency AC drive controllers is used for controlling three-phase asynchronous motors. They range from:

- 0.5 to 3 hp (0.37 to 2.2 kW) 240 V, single-phase input.
- 5 to 10 hp (3 to 7.5 kW) 230 V, three-phase input.
- 1 to 20 hp (0.75 to 15 kW) 460/480 V, three-phase input.

This instruction bulletin covers the technical characteristics, specifications, installation, and wiring of all ALTIVAR 28 drive controllers.

## REVISION LEVEL

This is the first release of this document.

## RECEIVING AND PRELIMINARY INSPECTION

Before installing the ALTIVAR 28 (ATV28) drive controller, read this manual and follow all precautions:

- Before removing the drive controller from its packing material, verify that it is not damaged from shipping. Any damage to the packing carton usually indicates improper handling. If any damage is found, notify the carrier and your Square D representative.
- After removing the drive controller from its packaging, visually inspect the exterior for shipping damage. If any shipping damage is found, notify the carrier and your sales representative.
- Verify that the drive controller nameplate and label conform to the packing slip and corresponding purchase order.

### **⚠ CAUTION**

#### **EQUIPMENT DAMAGE HAZARD**

Do not operate or install any drive controller that appears damaged.  
**Failure to follow this instruction can result in injury or equipment damage.**



## STORING AND SHIPPING

If the drive controller is not being immediately installed, store it in a clean, dry area where the ambient temperature is between -25 and +70 °C (-13 to +158 °F). If the drive controller must be shipped to another location, use the original shipping material and carton to protect it.

## TECHNICAL CHARACTERISTICS

**Table 1: Single Phase Supply Voltage: 208/230 V –15%, +10%, 50/60 Hz**

Catalog No.	Input Line Current <sup>[1]</sup>		Motor Power		Rated Output Current	Transient Output Current <sup>[2]</sup>	Total Dissipated Power at Rated Load	SC Rating
	208 V	230 V	kW	hp				
	A	A			A	A	W	kA
ATV28HU09M2U	6.9	6.4	0.37	0.5	3.3	3.6	32	1
ATV28HU18M2U	9.3	8.6	0.75	1	4.8	6	45	1
ATV28HU29M2U	15.5	14.3	1.5	2	7.8	10.9	75	1
ATV28HU41M2U	21.3	19.8	2.2	3	11	15	107	1

**Table 2: 3-Phase Supply Voltage: 208/230 V –15%, +10%, 50/60 Hz**

Catalog No.	Input Line Current <sup>[1]</sup>		Motor Power		Rated Output Current	Transient Output Current <sup>[2]</sup>	Total Dissipated Power at Rated Load	SC Rating
	208 V	230 V	kW	hp				
	A	A			A	A	W	kA
ATV28HU54M2U	16.8	15.4	3	4	13.7	18.5	116	5
ATV28HU72M2U	21.1	19.1	4	5	17.5	24.6	160	5
ATV28HU90M2U	36.3	33.2	5.5	7.5	27.5	38	250	22
ATV28HD12M2U	42.0	36.6	7.5	10	33	49.5	343	22

[1] Values correspond to the amount absorbed by drive controllers supplied with fault capacity equal to the short-circuit rating indicated in the table and under nominal conditions of load and speed of the associated motor without additional inductance.

[2] For 60 seconds.

[3] These power ratings are for a maximum switching frequency of 4 kHz, in continuous operation. The switching frequency is adjustable from 2 to 15 kHz. Above 4 kHz derate the nominal drive controller current. The nominal motor current should not exceed this value. Up to 12 kHz, derate by 10%, above 12 kHz derate by 20%.



**Table 3: 3-Phase Supply Voltage: 400/460 V –15%, +10%, 50/60 Hz**

Catalog No.	Input Line Current <sup>[1]</sup>		Motor Power		Rated Output Current <sup>[3]</sup>	Transient Output Current <sup>[2]</sup>	Total Dissipated Power at Rated Load	SC Rating
	400 V	460 V	kW	hp				
	A	A			A	A	W	kA
ATV28HU18N4U	3.6	3.2	0.75	1	2.3	3.5	33	5
ATV28HU29N4U	6.1	5.4	1.5	2	4.1	6.2	61	5
ATV28HU41N4U	8.0	7.0	2.2	3	5.5	8.3	81	5
ATV28HU54N4U	9.8	8.6	3	4	7.1	10.6	100	5
ATV28HU72N4U	12.5	10.7	4	5	9.5	14.3	131	5
ATV28HU90N4U	21.5	18.6	5.5	7.5	14.3	21.5	215	22
ATV28HD12N4U	24.7	21.1	7.5	10	17	25.5	281	22
ATV28HD16N4U	37.5	32.8	11	15	27.7	41.6	401	22
ATV28HD23N4U	42.4	35.8	15	20	33	49.5	495	22

[1] Values correspond to the amount absorbed by drive controllers supplied with fault capacity equal to the short-circuit rating indicated in the table and under nominal conditions of load and speed of the associated motor without additional inductance.

[2] For 60 seconds.

[3] These power ratings are for a maximum switching frequency of 4 kHz, in continuous operation. The switching frequency is adjustable from 2 to 15 kHz. Above 4 kHz derate the nominal drive controller current. The nominal motor current should not exceed this value. Up to 12 kHz, derate by 10%, above 12 kHz derate by 20%.

**Table 4: Minimum Dynamic Braking Resistance Values**

208/230 V Drive Controller Part No.	PA / PB Minimum Resistance Ω	460 V Drive Controller Part No.	PA / PB Minimum Resistance Ω
ATV28HU09M2U	65	ATV28HU18N4U	95
ATV28HU18M2U	45	ATV28HU29N4U	
ATV28HU29M2U	30	ATV28HU41N4U	70
ATV28HU41M2U		ATV28HU54N4U	
ATV28HU54M2U	25	ATV28HU72N4U	
ATV28HU72M2U		ATV28HU90N4U	
ATV28HU90M2U	10	ATV28HD12N4U	45
ATV28HD12M2U		ATV28HD16N4U	
		ATV28HD23N4U	25

## SPECIFICATIONS

**Table 5: Environment**

Degree of Protection	Open <sup>[1]</sup> UL Type 1 without removal of grey tape from the top of the controller and with the addition of the NEMA / UL Type 1 kit. IP20 when the grey tape is removed from the top of the controller.
Resistance to vibrations	1 g from 13 to 150 Hz
Pollution degree	Pollution degree 2 according to UL 840. Protect the drive controller against dust, corrosive gas, and falling liquid.
Maximum relative humidity	93% maximum, non-condensing and without dripping (provide heating system if there is condensation)
Maximum ambient temperature	Storage: -13 to +158 °F (-25 to +70 °C) Operation: +14 to +104 °F (-10 to +40 °C) without grey tape removed +14 to +122 °F (-10 to +50 °C) with grey tape removed
Altitude	Up to 3,300 ft (1,000 m) without derating; derate by 3% for each additional 3,300 ft (1,000 m)

**Table 6: Electrical Characteristics**

Input voltage	ATV28***M2U, 1-phase: 208 V -15% to 230 V +10% ATV28***M2U, 3-phase: 208 V -15% to 230 V +10% ATV28***N4U: 400 V -15% to 460 V +10%
Input frequency	50/60 Hz ±5%
Input phases	ATV28HU09M2U to HU41M2U: 1 ATV28HU54M2U to HD12M2U: 3 ATV28***N4U: 3
Output voltage	Maximum voltage equal to input voltage
Output frequency	0.5 to 400 Hz
Output phases	3
Max. transient current	150% of nominal drive controller current for 60 seconds
Braking torque	30% of nominal motor torque without dynamic braking (typical value). Up to 150% with optional dynamic braking resistor
Frequency resolution	Display: 0.1 Hz Analog inputs: 0.1 Hz for 100 Hz maximum
Switching frequency	Adjustable from 2.2 to 15 kHz
Drive controller protection	Galvanic isolation between power and control (power supplies, inputs, outputs) Protection against short circuits: <ul style="list-style-type: none"> <li>• in available internal sources</li> <li>• between output phases</li> <li>• between output phases and ground for 7.5 to 20 hp drive controllers</li> </ul> Thermal protection against overheating and overcurrents Undervoltage and overvoltage faults Overbraking fault
Motor protection	Protection integrated in the drive controller by I <sup>2</sup> t calculation

<sup>[1]</sup> Controller electrical creepage distances are designed for use in a pollution degree 2 environment per UL 840.

**DIMENSIONS AND WEIGHTS**

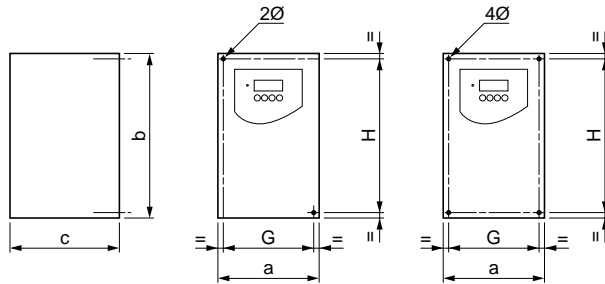

	a		b		c		G		H		2 Ø		4 Ø		Weight	
	mm	in.	mm	in.	mm	in.	mm	in.	mm	in.	mm	in.	mm	in.	kg	lb
<b>ATV28H•••••</b>																
U09M2U, U18M2U	105	4.2	130	5.2	140	5.6	93	3.7	118	4.7	5	0.20	—	—	1.8	4.0
U29M2U, U18N4U, U29N4U	130	5.2	150	6	150	6	118	4.7	138	5.5	—	—	5	0.20	2.5	5.5
U41M2U, U54M2U, U72M2U, U41N4U, U54N4U, U72N4U	140	5.6	195	7.8	163	6.5	126	5.0	182	7.3	—	—	5	0.20	3.8	8.4
U90M2U, D12M2U, U90N4U, D12N4U	200	8	270	10.8	170	6.8	180	7.2	255	10.2	—	—	6	0.24	6.1	13.5
D16N4U, D23N4U	245	9.8	330	13.2	195	7.8	225	9	315	2.6	—	—	6	0.24	9.6	21.2

**Figure 1: Dimensions and Weights**



## INSTALLATION

### Precautions

- Turn off all power before installing the drive controller. Place a "DO NOT TURN ON" label on the drive controller disconnect. Before proceeding with the installation, lock the disconnect in the open position.

### **⚠ DANGER**

#### **HAZARDOUS VOLTAGE**

Before working on this equipment:

- Disconnect all power.
- Place a "DO NOT TURN ON" label on the drive controller disconnect.
- Lock the disconnect in the open position.

**Electrical shock will result in death or serious injury.**

- The ALTIVAR 28 drive controller must be installed in a suitable environment.
- Install the drive controller vertically  $\pm 10^\circ$  with the power terminals at the bottom. Avoid placing the drive controller near any heat sources.
- Mount the drive controller on a flat, solid surface to achieve proper air flow.
- Verify that the voltage and frequency characteristics of the input line match the drive controller nameplate rating.
- Installation of a disconnect switch between the input line and the drive controller should be in accordance with national and local codes.
- Overcurrent protection is required. Install the line power fuses recommended in Tables 10 and 11 on page 25.
- Leave sufficient free space around the controller to ensure that the air required for cooling can circulate from the bottom to the top of the unit. See Figure 2 on page 7.

## Mounting and Temperature Conditions

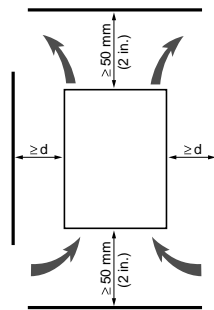

Allow 10 mm (0.4 in.) free space in front of drive controller.

**Figure 2: Minimum Clearances**

Refer to Figure 2 for dimension "d".

- From -10 to 40 °C:  
For  $d \geq 50$  mm (2 in.): no special precautions.  
For  $d = 0$  (drive controllers mounted side by side): remove the protective cover from the top of the drive controller, as shown in Figure 3 (the degree of protection becomes IP20).
- From 40 to 50 °C:  
For  $d \geq 50$  mm (2 in.): remove the protective cover from the top of the controller, as shown in Figure 3 (the degree of protection becomes IP20). If the cover is left on, derate the nominal drive controller current by 2.2% for every °C above 40 °C.  
For  $d = 0$ : remove the protective cover from the top of the drive controller, as shown in Figure 3 (the degree of protection becomes IP20), and derate the nominal drive controller current by 2.2% for every °C above 40 °C.
- From 50 to 60 °C: For  $d \geq 50$  mm (2 in.): remove the protective cover from the top of the drive controller, as shown in Figure 3 (the degree of protection becomes IP20), and derate the nominal drive controller current by 3% for every °C above 50 °C.

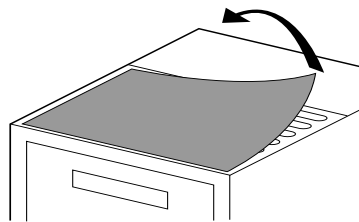

**Figure 3: Removing the Protective Cover**

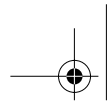

## Labels

The drive controller is supplied with four labels. The wiring diagram label comes affixed to the inside of the hinged cover. Three other self-adhesive labels are supplied with the drive controller and stored under the hinged cover. Affix these near the drive controller as required. They are:

- Programming the main parameters
- Description of fault codes
- A blank label for recording customer settings

*NOTE: Do not place labels on the heatsink or over the ventilating slots on the side of the drive controller.*

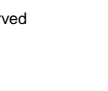
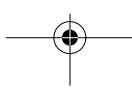
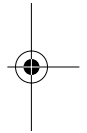
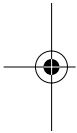

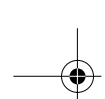

## Mounting in Type 12 (or IP54) Metal Enclosure

### Calculating Enclosure Size

The equation for calculating  $R_{th}$  ( $^{\circ}C/W$ ), the maximum allowable thermal resistance of the enclosure is as follows:

$$R_{th} = \frac{T_i - T_o}{P}$$

$T_i$  = Max. internal ambient temp. ( $^{\circ}C$ ) around the controller  
 $T_o$  = Max. external ambient temp. ( $^{\circ}C$ ) around enclosure  
 $P$  = Total power dissipated in enclosure (W)

For the power dissipated by the drive controllers at rated load, see Tables 1 through 3 on page 3.

Useful heat exchange surface area,  $S$  ( $in^2$ ), of a wall-mounted enclosure generally consists of the sides, top, and front. The minimum surface area required for a drive controller enclosure is calculated as follows:

$$S = \frac{K}{R_{th}}$$

$R_{th}$  = Thermal resistance of the enclosure (calculated previously)  
 $K$  = Thermal resistance per square inch of the enclosure  
 $K = 186$  with enclosure fan  
 $K = 233$  without enclosure fan

Consider the following points when sizing the enclosure:

- Use only metallic enclosures, since they have good thermal conduction.
- This procedure does not consider radiant or convected heat load from external sources. Do not install enclosures where external heat sources (such as direct sunlight) can add to enclosure heat load.
- If additional devices are present inside the enclosure, consider the heat load of the devices in the calculation.
- The actual useful area for convection cooling of the enclosure will vary depending upon the method of mounting. The method of mounting must allow for free air movement over all surfaces considered for convection cooling.

The following sample illustrates calculation of the enclosure size for an ATV28HU72N4U (5 hp) drive controller mounted in a Type 12 enclosure.

- Maximum external temperature:  $T_o = 25^{\circ}C$
- Power dissipated inside enclosure:  $P = 94$  W

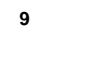
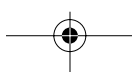

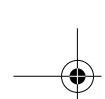

- Maximum internal temperature:  $T_i = 40\text{ °C}$
- Thermal resistance per square inch of enclosure:  $K = 186$
- Calculate maximum allowable thermal resistance,  $R_{th}$ :

$$R_{th} = \frac{40\text{ °C} - 25\text{ °C}}{94\text{ W}} = 0.16\text{ °C/W}$$

- Calculate minimum useful heat exchange surface area,  $S$ :

$$S = \frac{186}{0.16} = 1162.5\text{ in}^2$$

Useful heat exchange surface area ( $S$ ) of the proposed wall-mounted enclosure:

- Height: 24 in (610 mm)
- Width: 20 in (508 mm)
- Depth: 12 in (305 mm)

$$S = \begin{array}{ccc} \text{front area} & \text{top area} & \text{side area} \\ \downarrow & \downarrow & \downarrow \\ (24 \times 20) & + (20 \times 12) & + 2(24 \times 12) = 1296\text{ in}^2 \end{array}$$

If the selected enclosure does not provide the required surface area or does not meet application needs, consider the following:

- Use a larger enclosure.
- Add a passive heat exchanger to the enclosure.
- Add an air conditioning unit to the enclosure.





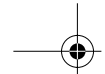

## Ventilation

When mounting the drive controller inside a Type 12 or IP54 enclosure, follow these ventilation precautions:

- Observe minimum clearance distances shown in Figure 2 on page 7.
- Follow the installation precautions on page 6.
- A stirring fan with filter may be necessary to circulate the air inside the enclosure and prevent hot spots in the drive controller and to distribute the heat uniformly to surfaces used for convection cooling.

If there is a possibility of condensation, keep the control supply switched on during periods when the motor is not running or install thermostatically controlled strip heaters.

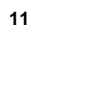
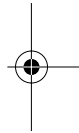
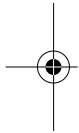

## ELECTROMAGNETIC COMPATIBILITY

This section focuses on applications requiring compliance to the European Community EMC directive. The ALTIVAR 28 controller is considered to be a component. It is neither a machine nor a piece of equipment ready for use in accordance with the European Community directives (machinery directive or electromagnetic compatibility directive). It is the user's responsibility to ensure that the machine meets these standards.

### Installation Precautions for Meeting EN55011 Class A

- Ensure that the grounds of the drive controller, the motor, and the cable shields are at equal potential.
- Use shielded cables with the shields connected to ground at both ends of the motor cable, control cables, and the braking resistor (if used). Conduit or metal ducting can be used for part of the shielding length, provided that there is no break in continuity.
- Ensure maximum separation between the power supply cable (line supply) and the motor cable.

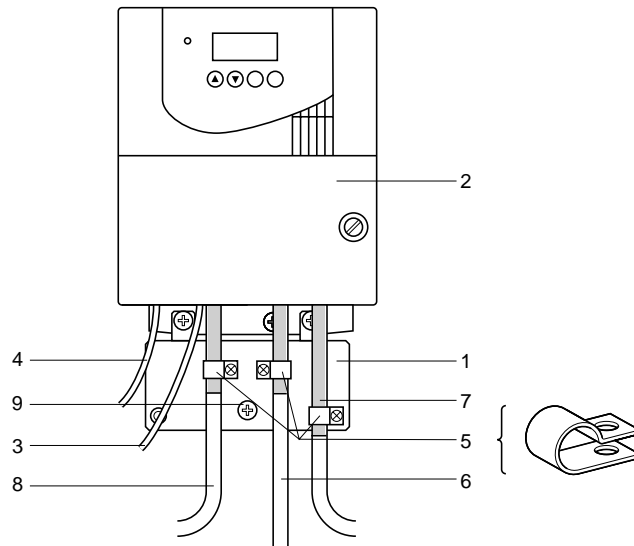
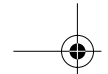

Figure 4: Installation Diagram



Description of parts in Figure 4:

1. Sheet metal grounded casing supplied with the drive controller, to be fitted as indicated on the diagram.
2. ALTIVAR 28 drive controller.
3. Non-shielded power supply wires or cables.
4. Non-shielded wires for the output of the safety relay contacts.
5. Cable 6, 7, and 8 shields must be attached and connected to ground as close as possible to the drive controller. Strip the shields. Use clamps of an appropriate size on the stripped portion of the shields for fastening to the sheet metal. Clamps should be stainless steel. The shields must be well clamped to the sheet metal in order to have a good contact.
6. Shielded cable for connection to the motor, with shielding connected to ground at both ends. This shielding must not be interrupted. If intermediate terminal blocks are used, they must be in EMC-shielded metal boxes.
7. Shielded cable for connection to control/command. For applications which require a large number of conductors, small cross-sections must be used ( $0.5 \text{ mm}^2$ ). This shielding must not be interrupted. If intermediate terminal blocks are used, they must be in EMC-shielded metal boxes.
8. Shielded cable for connecting the braking resistor, if used. The shielding must be connected to ground at both ends. This shielding must be unbroken, and if there are intermediate terminals, they must be in EMC shielded metal boxes.
9. Ground the screw for the motor cable on controllers with low horsepower ratings, as the screw on the heatsink is inaccessible.

*NOTE: If an additional input filter is used, it should be mounted on the drive controller and connected directly to the line supply by an unshielded cable. Connection 3 on the drive controller is then made using the filter output cable. Although there is an HF equipotential ground connection between the drive controller, the motor, and the cable shielding, it is still necessary to connect the PE protective conductors (green-yellow) to the appropriate terminals on each of the devices.*

*NOTE: It may be necessary to disconnect the shield at the motor end for very long cable runs to alleviate noise generation.*

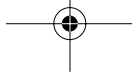

### EMC PLATE

An EMC plate is supplied with the drive controller for equipotential grounding. Place the EMC plate on the holes of the ATV28 heatsink using the 2 screws provided, as shown in Figure 5.

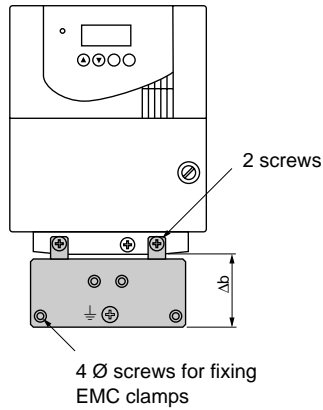

ATV28H.....	Δb		Ø	
	mm	in.	mm	in.
U09M2U, U18M2U, U29M2U, U41M2U, U54M2U, U72M2U, U18N4U, U29N4U, U41N4U, U54N4U, U72N4U	48	1.9	4	0.16
U90M2U, D12M2U, U90N4U, D12N4U, D16N4U, D23N4U	79	3.2	4	0.16

Figure 5: EMC Plate

**WIRING**

Before wiring the drive controller, perform the bus voltage measurement procedure on page 16. Figure 6 shows the location of the terminal strips. To access the terminals, remove the screws on the cover and tilt it open. ATV28 drive controllers have a removable plastic cable panel with knock-outs for routing cables.

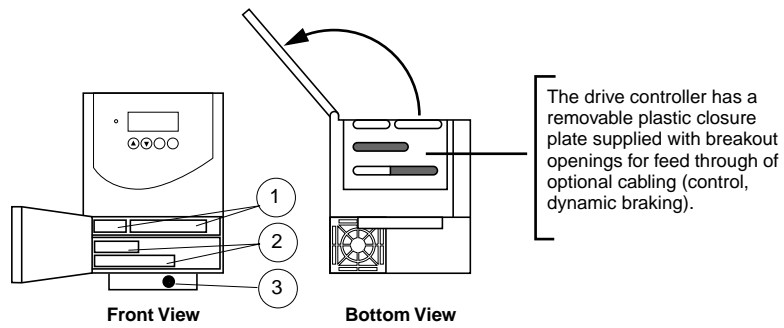

- 1 - Control terminals
- 2 - Power terminal (1 or 2 terminals depending on the rating)
- 3 - Ground screw for motor cable (on low ratings only)

**Figure 6: Terminal Strip Locations**

**Bus Voltage Measurement Procedure**

<b>⚠ DANGER</b>	
<b>HAZARDOUS VOLTAGE</b>	
<ul style="list-style-type: none"> <li>• Read and understand the Bus Voltage Measurement Procedure before performing the procedure. Measurement of DC bus capacitor voltage must be performed by qualified personnel.</li> <li>• DO NOT short across capacitors or touch unshielded components or terminal strip screw connections with voltage present.</li> <li>• Many parts in this drive controller, including printed wiring boards, operate at line voltage. DO NOT TOUCH. Use only electrically insulated tools.</li> </ul>	
<b>Failure to follow these instructions will result in death or serious injury.</b>	

Measure the bus voltage between the PO (+) and PC (-) terminals. Refer to Figure 7 for terminal locations.

ATV28HU09M2U, U18M2U, U29M2U, U49M2U:

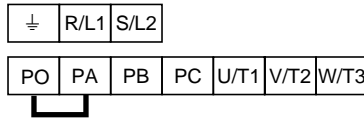

ATV28HU54M2U, U72M2U, U18N4U, U29N4U, U41N4U, U54N4U, U72N4U:

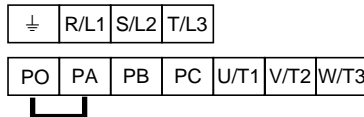

ATV28HU90M2U, D12M2U, U90N4U, D12N4U, D16N4U, D23N4U:

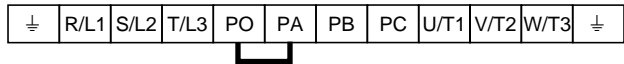

**Figure 7: Power Terminal Location**

To measure the bus capacitor voltage:

1. Disconnect all power from the drive controller.
2. Wait three minutes to allow the DC bus to discharge.

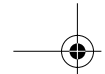

3. Open the door.
4. Set the voltmeter to the 1000 Vdc scale. Measure the voltage between the (+) and (-) terminals to verify that the DC voltage is less than 45 V for each measurement.
5. If the bus capacitors are not fully discharged, contact your local Square D representative—do not operate the drive controller.
6. Close the door and hand tighten the screw.

### General Wiring Practices

Good wiring practice requires the separation of control circuit wiring from all power (line) wiring. Power wiring to the motor must have the maximum possible separation from all other power wiring, whether from the same drive controller or other drive controllers; **do not run in the same conduit**. This separation reduces the possibility of coupling electrical transients from power circuits into control circuits or from motor power wiring into other power circuits.

### CAUTION

#### EQUIPMENT DAMAGE HAZARD

Follow the wiring practices described in this document in addition to those already required by the National Electric Code and local electrical codes.

**Failure to follow this instruction can result in injury or equipment damage.**

Follow the practices below when wiring ALTIVAR 28 drive controllers:

- Use metallic conduit for all drive controller wiring. Do not run control and power wiring in the same conduit.
- Separate metallic conduits carrying power wiring or low-level control wiring by at least 3 in. (7.62 cm).
- Separate non-metallic conduits or cable trays used to carry power wiring from metallic conduit carrying low-level control wiring by at least 12 in. (30.5 cm).
- Whenever power and control wiring cross, the metallic conduits and non-metallic conduits or trays must cross at right angles.
- Equip all inductive circuits near the drive controller (relays, contactors, solenoid valves) with noise suppressors or connect them to a separate circuit.





### Branch Circuit Connections

All branch circuit components and equipment (such as transformers, feeder cables, disconnect devices, and protective devices) must be rated for the maximum input current of the ALTIVAR 28 drive controller, not the motor full load current. The drive controller input current is stamped on the nameplate.

#### **WARNING**

##### **OVERCURRENT PROTECTIVE DEVICES MUST BE PROPERLY COORDINATED**

- To achieve published fault-withstand current ratings, install the specified fuses which are listed on the drive controller nameplate and in Tables 10 and 11 on page 25 of this manual.
- Do not connect the drive controller to a power feeder whose short circuit capacity exceeds the drive controller withstand fault rating listed on the drive controller nameplate.

**Failure to follow these instructions can result in death, serious injury or equipment damage.**

### Output Wiring Precautions

#### **WARNING**

##### **DRIVE CONTROLLER DAMAGE**

The drive controller will be damaged if input line voltage is applied to output terminals (U, V, W). Check power connections before energizing the drive controller.

**Failure to follow this instruction can result in death, serious injury or equipment damage.**

The drive controller is sensitive to the amount of capacitance (either phase-to-phase or phase-to-ground) present on the output power conductors. If excessive capacitance is present, the drive controller may trip on overcurrent.







Follow these guidelines when selecting output cable:

- Cable type: the cable selected must have a low capacitance phase-to-phase and to ground. Do not use mineral-impregnated cable because it has a very high capacitance. Immersion of cables in water increases capacitance.
- Cable length: the longer the cable, the greater the capacitance. Cable lengths greater than 100 ft (30.5 m) may affect controller and/or motor performance.
- Proximity to other output cables: because of high frequency switching and increased capacitance, the drive controller may fault under some conditions.
- **Do not use lightning arrestors and/or power factor correction capacitors on the output of the drive controller.**

Wiring needs a minimum inductance to protect the drive controller output from short circuits. Provide at least 20 in. (500 mm) of cable at the drive controller output (U, V, W).

### **⚠ CAUTION**

#### **DRIVE CONTROLLER SWITCH FAILURE**

For proper drive controller short circuit protection, certain values of inductance may be required in the output power wiring. Inductance can be supplied by the power wiring or auxiliary inductors.

**Failure to follow this instruction can result in injury or equipment damage.**

## **Grounding**

For safe, dependable operation, ground the drive controller according to National Electrical Code and all local codes. To ground the drive controller:

- Connect a copper wire from the equipment ground terminal to the power system ground conductor. Wire size is determined by the drive controller size and by national and local codes.
- Verify that resistance to ground is one ohm or less. Improper grounding causes intermittent and unreliable operation.





**⚠ DANGER**

**HAZARDOUS VOLTAGE**

Ground equipment using the provided ground connecting point as shown in Figure 8. The drive controller panel must be properly grounded before power is applied.

**Electrical shock will result in death or serious injury.**

Ground multiple drive controllers as shown in Figure 8. Do not loop or series the ground cables.

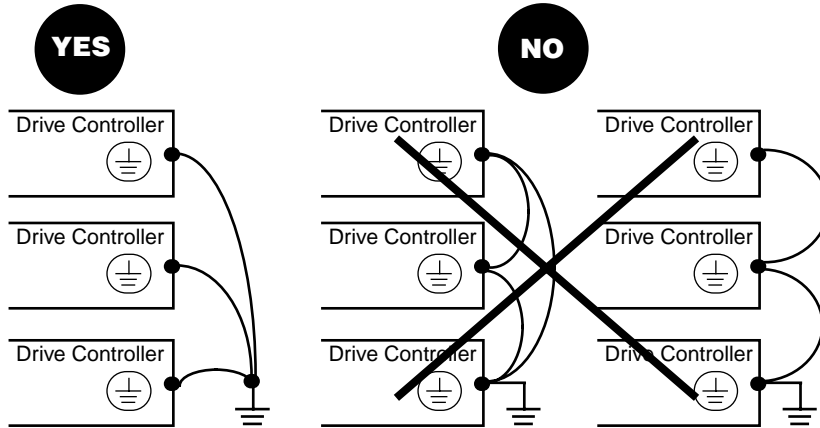

**Figure 8: Grounding Multiple Drive Controllers**

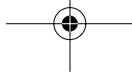

**Power Terminals**

**Table 7: Power Terminal Wire Size and Torque**

ATV28H*****	Max. Wire Size (75 °C copper)		Tightening Torque	
	AWG	mm <sup>2</sup>	N•m	lb-in
U09M2U, U18M2U	AWG 14	2.5	0.8	7.1
U29M2U, U18N4U, U29N4U	AWG 12	3	1.2	10.7
U41M2U, U54M2U, U72M2U, U41N4U, U54N4U, U72N4U	AWG 10	5	1.2	10.7
U90M2U, D12M2U, U90N4U, D12N4U	AWG 6	16	2.5	22.2
D16N4U, D23N4U	AWG 3	25	4.5	40.0

**Table 8: Power Terminal Functions**

Terminal <sup>[1]</sup>	Function	For ATV28H*****
⏏	ALTIVAR ground terminal	All models
L1	Input power	All models
L2		
L3		
PO	DC bus + polarity	All models
PA	Output to braking resistor	All models
PB	Output to braking resistor	All models
PC	DC bus - polarity	All models
U	Output to motor	All models
V		
W		
⏏	ALTIVAR ground terminal	U90M2U, D12M2U, U90N4U, D12N4U, D16N4U, D23N4U

[1] See Figure 9 on page 22 for arrangement.



ATV28HU09M2U, U18M2U, U29M2U, U49M2U:

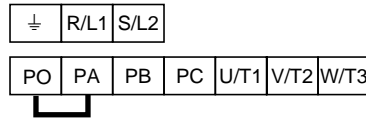

ATV28HU54M2U, U72M2U, U18N4U, U29N4U, U41N4U, U54N4U, U72N4U:

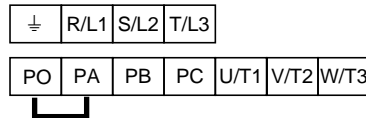

ATV28HU90M2U, D12M2U, U90N4U, D12N4U, D16N4U, D23N4U:



Figure 9: Power Terminal Arrangement

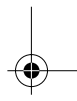
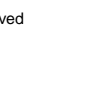
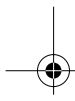

**Control Terminals**

**Table 9: Control Terminal Description**

Terminal	Function	Electrical specifications
R1A R1B R1C	R1A is a N.O. contact. When controller is powered with no fault, contact is closed. R1B is a N.C. contact. When controller is powered with no fault, contact is open. R1C is common.	Min. switching capacity • 10 mA for 5 Vdc Max. switching capacity on inductive load (cos φ = 0.4 and L/R = 7 ms): • 1.5 A for 250 Vac and 30 Vdc
R2A R2C	N/O contact of R2 programmable relay	
COM	I/O common for logic	
AI1	Analog voltage input. Used for speed reference input.	Analog input 0 to 10 V • impedance 30 kΩ • resolution 0.01 V • precision ± 4.3%, linearity ± 0.2%, of max. value • Sampling time 4 ms max.
+10	Power supply for speed reference 1 to 10 kΩ	+10 V (+ 8% - 0), 10 mA max, protected against short-circuits and overloads
AI2 AIC	AI2 is an analog voltage input. Used for speed reference input or feedback. AIC is an analog current input. AI2 or AIC are assignable. Use either, but not both.	Analog input 0 to 10 V, impedance 30 kΩ  Analog input X - Y mA. X and Y can be programmed from 0 to 20 mA, impedance 450 Ω  Resolution, precision, and sampling time of AI2 or AIC = AI1.
AO	Analog output. Used for indication motor current, motor frequency, motor torque, and motor power.	Output can be programmed for 0–20 mA or 4–20 mA • Precision ± 6% of the max. value, max. load impedance 800 Ω.
LI1 LI2 LI3 LI4	Logic inputs. Function depends on configuration. See page 29.	Programmable logic inputs • + 24 V power supply (max. 30 V) • Impedance 3.5 kΩ • State 0 if < 5 V, state 1 if > 11 V • Sampling time 4 ms max.
+ 24	Logic input power supply	+ 24 V protected against short-circuits and overloads, min. 19 V, max. 30 V. Max. customer current available 100 mA

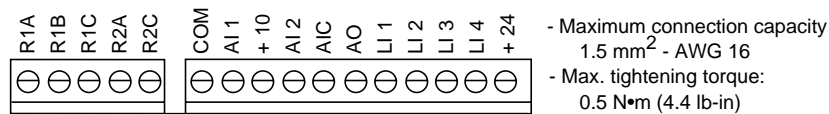

**Figure 10: Control Terminal Arrangement**

**Wiring Diagram**

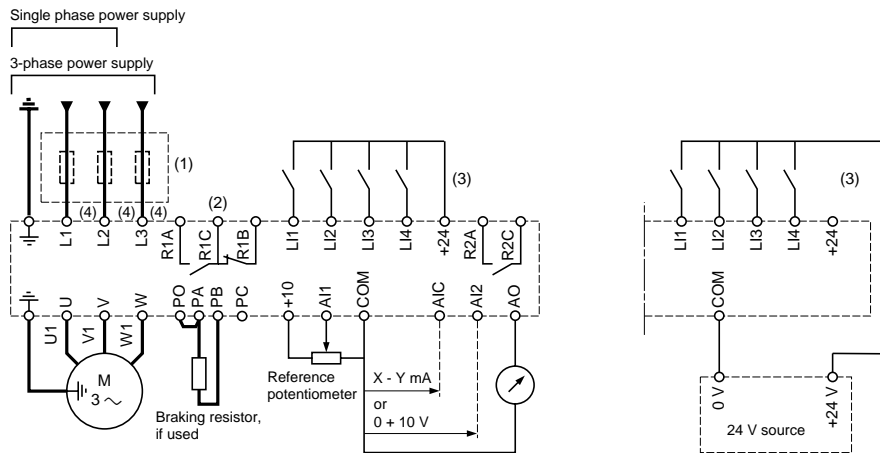

- (1) Line inductor, if used (single phase or 3-phase).
- (2) Safety relay contacts, for remote indication of the drive controller status.
- (3) Internal + 24 V. If an external + 24 V source is used, connect the 0 V from that source to the COM terminal, and do not use the + 24 terminal on the drive controller.
- (4) Place fuses here. Refer to "Recommended Fuses" on page 25.

**Figure 11: ALTIVAR 28 Drive Controller Wiring Diagram**

*NOTE: Fit interference suppressors to all inductive circuits near the drive controller or coupled to the same circuit (relays, contactors, solenoid valves, etc).*

**RECOMMENDED FUSES**

**Table 10: Recommended Fuses for 230 V Drive Controllers**

Motor		Drive Controller ATV28H*****	Fuses (all 600 V)	
kW	hp		Class CC	Class J [1]
0.37	0.5	U09M2U	10 A	10 A
0.75	1	U18M2U	15 A	15 A
1.5	2	U29M2U	20 A	20 A
2.2	3	U41M2U	30 A	30 A
3	—	U54M2U	25 A	25 A
4	5	U72M2U	30 A	30 A
5.5	7.5	U90M2U	—	50 A
7.5	10	D12M2U	—	60 A

[1] Either fast acting or time delay Class J fuses can be used.

**Table 11: Recommended Fuses for 460 V Drive Controllers**

Motor		Drive Controller ATV28H*****	Fuses (all 600 V)	
kW	hp		Class CC	Class J [1]
0.75	1	U18N4U	5 A	5 A
1.5	2	U29N4U	10 A	10 A
2.2	3	U41N4U	10 A	10 A
3	—	U54N4U	15 A	15 A
4	5	U72N4U	15 A	15 A
5.5	7.5	U90N4U	30 A	30 A
7.5	10	D12N4U	—	35 A
11	15	D16N4U	—	50 A
15	20	D23N4U	—	60 A

[1] Either fast acting or time delay Class J fuses can be used.

Equip all inductive circuits near the drive (relays, contactors, solenoid valves) with noise suppressors or connect them to a separate circuit.

When commanding the power by line contactor, avoid frequently opening and closing the line contactor which could cause premature failure of the filtering capacitors and precharge resistor. Use inputs LI1 to LI4 to command the drive. Limit operations of the line contactor to less than once per minute.

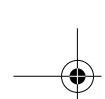

## AVAILABLE TORQUE

Continuous duty:

- For self-ventilated motors, motor cooling depends on the speed.
- Continuous duty results in derating for speeds less than 50% of the nameplate motor speed.

Operation in overspeed:

- In overspeed operation, the voltage no longer increases with the frequency, resulting in reduced induction in the motor which translates into loss of torque. Consult the motor manufacturer to ensure that the motor can operate in overspeed.
- For a special motor, the nominal frequency and the maximum frequency can be adjusted between 40 and 320 Hz.

### **▲ CAUTION**

#### **MACHINERY OVERSPEED**

Some motors and/or loads may not be suited for operation above nameplate motor speed and frequency. Consult motor manufacturer before operating motor above rated speed.

**Failure to follow this instruction can result in injury or equipment damage.**

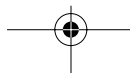



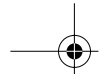

## BASIC DRIVE CONTROLLER FUNCTIONS

### Fault Relay, Reset

The fault relay (R1) is energized when the drive controller is powered up and there is no fault. It has a common point, N.O., and N.C. contact.

The drive controller can be reset after a fault by one of the following:

- Powering down the drive controller until the display and the red LED extinguish, then powering it up again.
- Automatically after certain faults when the "automatic restart" function has been activated. See page 44 for information on how to set Automatic Restart.
- Via a logic input assigned to the "fault reset" function (see page 31).

### Drive Controller Thermal Protection

Thermal protection is provided by a thermistor fitted on the heatsink or integrated in the power module. It supplies indirect protection of the drive controller against overloads by current limit. Typical tripping points are:

- Motor current equal to 185% of nominal drive controller current for 2 seconds
- Motor current equal to 150% of nominal drive controller current for 60 seconds.

### Drive Controller Ventilation

The fan is powered automatically when the drive controller is unlocked (i.e., receiving an operating direction signal and a reference signal). It is powered down a few seconds after the drive controller is locked (when motor speed is less than 0.5 Hz and injection braking is completed).

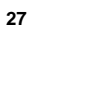
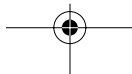

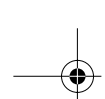

## Motor Thermal Protection

Thermal protection by calculating  $I^2t$ .

*NOTE: The motor thermal state memory is reset to zero when the drive controller is switched off.*

### CAUTION

#### LOSS OF MOTOR OVERLOAD PROTECTION

- Setting the Ith parameter to maximum will disable internal motor overload protection function.
- In this case, external motor overload protection must be provided.

When using external overload relays connected to the drive controller output, the overload relay must be capable of operation over the expected range of drive controller output frequencies (including direct current).

When DC injection braking is used:

- The overload relay must be suitable for operation with direct current flowing in the motor.
- Do not use overload relays equipped with current transformers for sensing the motor current.

**Failure to follow these instructions can result in injury or equipment damage.**

### CAUTION

#### MOTOR OVERHEATING

This drive controller does not provide direct thermal protection for the motor. Use of a thermal sensor in the motor may be required for protection at all speeds and load conditions. Consult the motor manufacturer for thermal capability of the motor when operated over the desired speed range.

**Failure to follow this instruction can result in injury or equipment damage.**

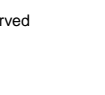



## CONFIGURABLE LOGIC AND ANALOG I/O FUNCTIONS

### Logic Input Functions

#### Direction Of Operation: Forward / Reverse

Reverse operation can be disabled for applications with a single direction of motor rotation.

#### 2-Wire Control

Run (forward or reverse) and stop are controlled by the same logic input. State 1 is run, state 0 is stop. On power-up, on a manual fault reset, or after a stop command, the motor can only be powered after the "forward", "reverse", and "DC injection stop" commands have been reset. If the automatic restart function is configured (parameter Atr in the drC menu), reset is not necessary.

#### 3-Wire Control

Run (forward or reverse) and stop are controlled by 2 different logic inputs. LI1 is always assigned to the stop function. Stop occurs on opening (state 0) the input. The pulse on the run input is memorized until the stop input is opened. On power-up, on a manual fault reset, or after a stop command, the motor can only be powered once the "forward", "reverse", and "DC injection stop" commands have been reset.

#### Ramp Switching

Switching between first (ACC, DEC) and second (AC2, DE2) acceleration ramps. Ramp switching is achieved by activating a logic input LIx or by detection of an adjustable frequency threshold Frt.

#### Jog

Low speed operation pulse. If the JOG contact is closed and then the operating direction contact is activated, the ramp is 0.1 seconds regardless of the ACC, dEC, AC2, and dE2 settings. If the operating direction contact is closed and then the JOG contact is activated, the configured ramps are used.

The minimum time between 2 JOG operations is 0.5 seconds. The JOG speed parameter is accessed in the adjust menu.

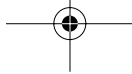

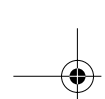

### Preset Speeds

Two, four, or eight speeds can be preset requiring one, two, or three logic inputs respectively. Preset speeds must be assigned in the following order:

1. PS2 (LIx)
2. PS4 (LIy)
3. PS8 (LIz)

Preset speeds must be unassigned in the reverse order.

### Speed Reference Switching

Two references are switched (AI1 reference and AI2 or AIC reference) by a logic input command. This function automatically assigns AI2 or AIC to speed reference 2. See "Auto/Manual Operation with PI" on page 32.

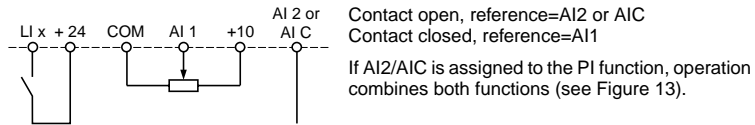

Figure 12: Reference Switching Connection Diagram

### Freewheel Stop

Stops the motor by the resistive torque only. The motor power supply is cut. Freewheel stop is activated when the logic input assigned to this function opens (state 0).

### DC Injection Stop

DC injection braking is activated when the logic input assigned to this function closes (state 1), or automatically activated if the frequency is below 0.5 Hz.

### Fast Stop

Fast stop is a braked stop with the current deceleration ramp time divided by 4 within the limits of the braking possibilities. Fast stop is activated when the logic input assigned to this function opens (state 0).



### Fault Reset

Fault reset clears the memorized fault and resets the drive controller if the cause of the fault has disappeared, except for OCF (overcurrent), SCF (motor short-circuit), EEF, and InF (internal faults) faults, which require the controller to be powered down to accomplish fault reset.

See Table 14 on page 57.

### Forced Local Mode When Using The Serial Link

Changes from serial link mode to local mode (control via the terminal block or keypad).

### Analog Input Functions

AI1 is a 0 to +10 V analog input which is used for speed reference. In addition, one of two other analog inputs may be used:

- AI2: 0 to +10 V or +2 to +10 V voltage input
- AIC: 0 to 20 mA (factory setting) or 4 to 20 mA current input.

Analog input can be assigned to reference summing with AI1 or PI feedback.

#### Reference summing with AI1

The frequency reference from AI2/AIC can be summed with AI1.

#### PI Feedback

This assignment automatically configures AI1 as PI setpoint input. AI2 or AIC is the PI feedback input.

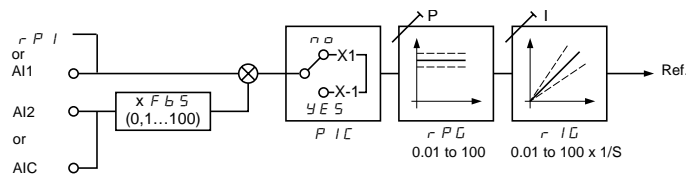

**Figure 13: PI Feedback**

To set up the PI regulator, with the system in open loop configuration (sensor not connected), adjust High Speed setting (HSP) so that maximum flow or pressure is obtained. Then connect the sensor. Adjust PIC to yes for reverse direction.

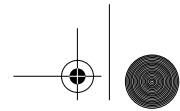

The values of proportional gain (rPG) and integral gain (rIG) are factory set to give adequate performance for most applications. Factory setting for both parameters is 1.00, meaning that the output is modified by 1.00 times the input error for the proportional component and 1.00 times the input error for one second for the integral component. If improved dynamic performance is required, these parameters can be adjusted over the range of 1.00 to 100, or if the system is unstable, from 0.01 to 0.99.

### Auto/Manual Operation with PI

This function combines the PI regulator and reference switching by a logic input. The speed reference is given by AI1 or by the PI function.

### R2 Relay Functions

**Frequency threshold attained (FtA):** The relay contact is closed if the motor frequency is greater than or equal to the frequency threshold set by Ftd in the adjust menu.

**Speed reference attained (SrA):** The relay contact is closed if the motor frequency is greater than or equal to the speed reference value.

**Current threshold attained (CtA):** The relay contact is closed if the motor current is greater than or equal to the current threshold set by Ctd in the adjust menu.

**Thermal state attained (tSA):** The relay contact is closed if the motor thermal state is greater than or equal to the thermal state threshold set by ttd in the adjust menu.

### Analog Output (AO) Functions

The analog output (AO) is a current output which can be configured for 0–20 mA or 4–20 mA.

**Motor current:** supplies the image of the motor rms current. 20 mA corresponds to twice the nominal motor thermal current Ith.

**Motor frequency:** supplies the motor frequency calculated by the drive controller. 20 mA corresponds to the maximum frequency (parameter tFr).

**Motor torque:** supplies the image of the motor torque as an absolute value. 20 mA corresponds to twice the nominal motor torque (typical value).

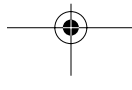

**Power:** supplies the image of the power supplied to the motor by the drive controller. 20 mA corresponds to twice the nominal drive controller power.

### Function Compatibility

The choice of application functions may be limited by the number of I/O and by the fact that some functions are incompatible with one another. Functions not listed in this table are fully compatible.

	DC injection braking	Summing input	PI regulator	Reference switching	Freewheel stop	Fast stop	JOG operation	Preset speeds
DC injection braking					↑			
Summing input			●	●				
PI regulator		●					●	●
Reference switching		●						●
Freewheel stop	←					←		
Fast stop					↑			
JOG operation			●					←
Preset speeds			●	●			↑	

- Incompatible functions
- Compatible functions
- N/A

Priority functions (the arrow points to the function that takes priority):

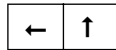

**NOTE:** Stop functions take priority over run commands. Speed references via logic command take priority over analog references.

## PROGRAMMING AND SET-UP

### Preliminary Recommendations

#### **⚠ WARNING**

##### **UNINTENDED EQUIPMENT OPERATION**

Parameter changes affect drive controller operation. Most parameter changes require pressing ENT. Some parameter changes, such as reference frequency, take effect as soon as you press the up or down arrow keys. Read and understand this manual before programming the drive controller.

**Failure to follow this instruction can result in death or serious injury.**

Before powering up and configuring the drive controller:

- Power down the logic inputs (state 0) to prevent accidental start-up. Otherwise, an input assigned to the run command may cause the motor to start immediately when exiting the configuration menus.
- If line starting the drive controller, avoid operating the contactor frequently to avoid premature wear of the filter capacitors. Use inputs L11 to L14 to control the drive controller. This is vital for cycles less than 60 seconds, otherwise the load resistor may be damaged.
- Ensure that changes to the current operating settings do not present any hazard. Changes should be made with the drive controller stopped.
- Ensure that the programmed settings are compatible with the wiring layout used.

If you are changing the factory configuration, record your parameter settings in the Configuration Tables beginning on page 52.

Programming the ALTIVAR 28 controller is simplified by internal sequence selections and interlocks. To gain the maximum benefit from this, it is recommended that the menus be accessed in the following order, but not all steps are necessary:

1. I/O
2. drC
3. Set



### Factory Settings

The ALTIVAR 28 drive controller is preset for most constant torque applications. Table 12 lists the factory settings.

**Table 12: Factory Settings**

Function	Setting
Display	Drive ready (when stopped) Reference frequency (when running)
Base frequency	50 Hz <sup>[1]</sup>
Motor voltage	230 V or 400 V, depending on the model
Acceleration and deceleration ramps	3 s
Low speed	0 Hz
High speed	50 Hz
Frequency loop gain	Standard
Motor thermal current	Nominal drive controller current
DC braking current at stop	0.7 times nominal drive controller current for 0.5 s
Operation	Constant torque with sensorless vector control
Logic inputs	2 run directions (LI1, LI2) 4 preset speeds (LI3, LI4): 0 Hz, 5 Hz, 25 Hz, 50 Hz
Analog inputs	AI1: 0 to +10 V reference AI2 (0 to +10V) or AIC (0 to 20 mA) summed with AI1
Relay R2	Speed reference reached
Analog output	0–20 mA, motor frequency
Deceleration ramp adaptation	Automatic in the case of overvoltage when braking
Switching frequency	4 kHz



[1] To change base frequency to 60 Hz, see page 37.

To modify these adjustments, use the keypad to change the parameter settings. The following section explains the keypad and parameters.

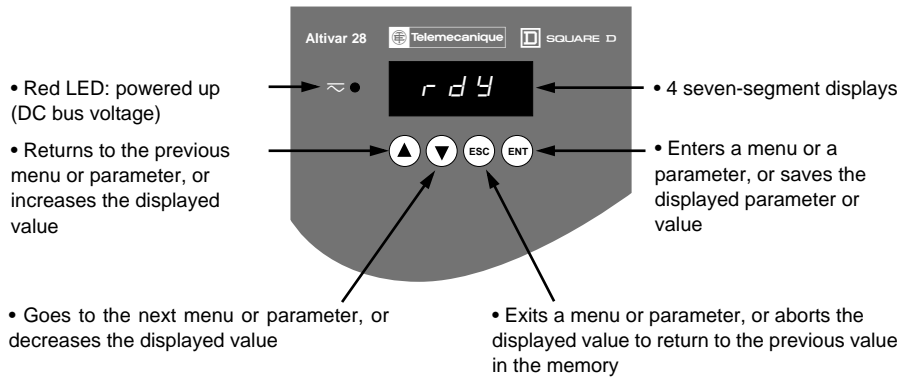
### Using the Keypad Display



**Figure 14: Keypad Display**

*NOTE: Pressing  or  does not store the choices. To store the displayed choice, press . The display flashes when a value is stored.*

Normal display, with no fault present:

- Init: Initialization sequence.
- rdY: drive controller ready
- 43.0: Display of the frequency reference
- dcb: DC injection braking in progress
- rtrY: Automatic restart in progress
- nSt: Freewheel stop command
- FSt: Fast stop command

**Access to Menus**

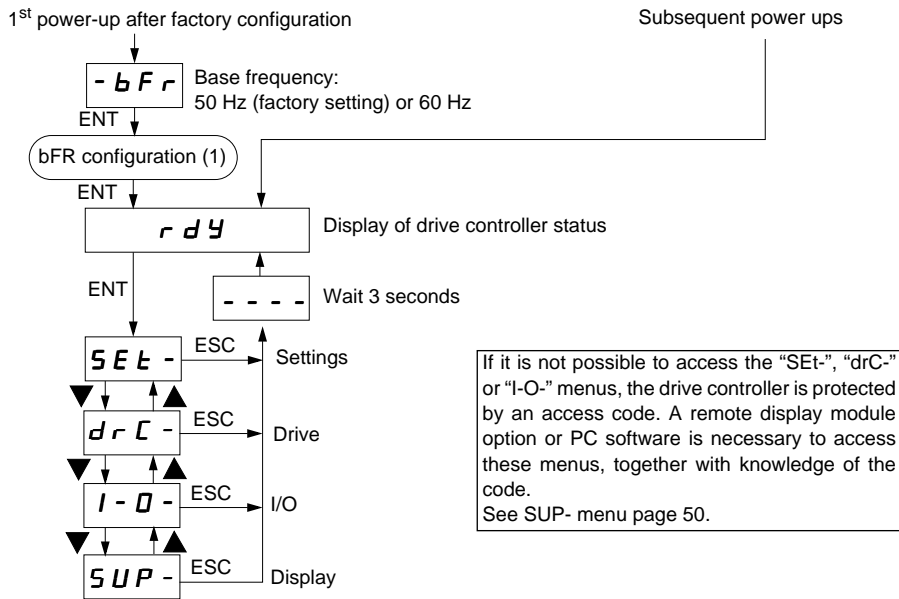

**Figure 15: Access to Menus**

Configure bFr at the first power-up, using the same procedure as for the other parameters, as described above. Subsequently bFr can only be modified after a return to "factory settings".

### Access to Parameters

There are three types of parameters:

- Display: values displayed by the drive controller.
- Adjustment: can be changed during operation or when the controller is stopped.
- Configuration: can only be modified when the controller is stopped and no braking is taking place. Can be displayed during operation

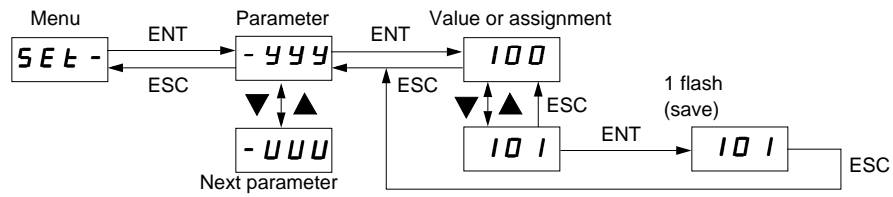

Figure 16: Access to Parameters

**PROGRAMMING CODES**

**Adjust Menu S E L -**

Code	Assignment	Adjustment range	Factory setting
- L F r	Speed reference via the display module. This parameter appears with the remote display module option when control of the drive controller via the display module is enabled: LCC parameter in I-O- menu.	LSP to HSP	
- r P I	PI reference This parameter appears when analog input AIC/AI2 is assigned to the internal PI function (AIC = PII).	0.0 to 100.0%	0.0
- r D t	Direction of operation. This parameter appears when the "local control" option is present. It defines the direction of operation: - forward: For, - reverse: rrS	For - rrS	For
- A C C	Acceleration and deceleration ramp times.	0.0 to 3600 s	3 s
- d E C	Defined to range from 0 to nominal motor frequency (FrS)	0.0 to 3600 s	3 s
- A C 2	2nd acceleration ramp time	0.0 to 3600 s	5 s
- d E 2	2nd deceleration ramp time These parameters are accessible when the ramp switching threshold (Fr <sub>t</sub> parameter in the drC- menu) is other than 0 Hz or when a logic input is assigned to ramp switching.	0.0 to 3600 s	5 s
- L S P	Low speed	0 to HSP	0 Hz
- H S P	High speed: ensure that this setting is appropriate for the motor and the application.	LSP to tFr	bFr
- I t H	Current used for the motor thermal protection. Set ItH to the nominal current marked on the motor rating plate. To disable thermal protection, increase the value to the maximum (ntH displayed).	0.50 to 1.15 In [1]	In [1]

[1] In is the nominal drive controller current shown in the catalogue and on the drive controller rating plate.

The parameters in shaded boxes appear if the corresponding functions have been configured in the drC- or I-O- menus.

Adjust Menu **5 E L -** (continued)

Code	Assignment	Adjustment range	Factory setting
- <i>U F r</i>	Optimizes the torque at very low speed	0 to 100%	20
- <i>S L P</i>	Adjusts the slip compensation around the value set by the nominal motor speed. This parameter only appears when parameter U Ft = n in the drC-menu.	0.0 to 5.0 Hz	According to controller output
- <i>F L G</i>	Frequency loop gain Linked to the inertia and the resistive torque of the driven mechanism: - machines with high resistive torque or high inertia: gradually reduce the gain in the range 33 to 0 - machines with fast cycles, low resistive torque and low inertia: gradually increase the gain in the range 33 to 100. Too high a gain may result in operating instability.	0 to 100%	33
- <i>I d C</i>	Level of DC injection braking current After 5 seconds the injection current is peak limited at 0.5 I <sub>th</sub> if it is set at a higher value.	0.1 I <sub>th</sub> to I <sub>n</sub> <sup>[1]</sup>	0.7 I <sub>n</sub> <sup>[1]</sup>
- <i>t d C</i>	DC injection standstill braking time When the time is increased to 25.5 s, "Cont" is displayed. The DC injection is then continuous at standstill.	0 to 25.4 s Cont.	0.5 s
- <i>J P F</i>	Skip frequency prevents prolonged operation at a frequency range of 2 Hz around JPF. This function prevents a critical speed which leads to resonance. Setting the function to 0 renders it inactive.	0 to HSP	0 Hz
- <i>J O G</i>	Jog operating frequency	0 to 10 Hz	10 Hz
- <i>r P G</i>	PI regulator proportional gain	0.01 to 100	1
- <i>r I G</i>	PI regulator integral gain	0.01 to 100 / s	1 / s
- <i>F b S</i>	PI feedback multiplication coefficient	0.1 to 100	1
- <i>P I C</i>	Reversal of the direction of correction of the PI regulator: no: normal, YES: reverse	no - YES	no

[1] I<sub>n</sub> is the nominal drive controller current shown in the catalogue and on the drive controller rating plate..

The parameters in shaded boxes appear if the corresponding functions have been configured in the drC- or I-O- menus.

Adjust Menu **5 E L -** (continued)

Code	Assignment	Adjustment range	Factory setting
- 5 P 2	2 <sup>nd</sup> preset speed	LSP to HSP	10 Hz
- 5 P 3	3 <sup>rd</sup> preset speed	LSP to HSP	15 Hz
- 5 P 4	4 <sup>th</sup> preset speed	LSP to HSP	20 Hz
- 5 P 5	5 <sup>th</sup> preset speed	LSP to HSP	25 Hz
- 5 P 6	6 <sup>th</sup> preset speed	LSP to HSP	30 Hz
- 5 P 7	7 <sup>th</sup> preset speed	LSP to HSP	35 Hz
- F L d	Motor frequency threshold beyond which the contact on relay R2 closes	0 to HSP	bFr
- L L d	Current threshold beyond which the contact on relay R2 closes	0.1 I <sub>nH</sub> to 1.5 I <sub>n</sub> <sup>[1]</sup>	1.5 I <sub>n</sub> <sup>[1]</sup>
- L L d	Motor thermal state threshold beyond which the contact on relay R2 closes	1 to 118%	100%
- L L 5	Low speed operating time Following operation at LSP for a defined period, a motor stop is requested automatically. The motor restarts when the frequency reference is greater than LSP and if a run command is still present. Caution: value 0 corresponds to an unlimited period	0 to 25.5 s	0 (no time limit)

[1] I<sub>n</sub> is the nominal drive controller current shown in the catalogue and on the drive controller rating plate.

The parameters in shaded boxes appear if the corresponding functions have been configured in the drC- or I-O- menus.

Drive Menu **dr C -**

The parameters can only be modified with the drive controller stopped and locked, except for Frt, SFr, nrd and SdS, which can be adjusted with the controller running.

Drive performance can be optimized by:

- Entering the values given on the rating plate,
- Performing an auto-tune operation (on a standard asynchronous motor)

Code	Assignment	Adjustment range	Factory setting
- Un 5	Nominal motor voltage marked on the rating plate. The adjustment range depends on the drive controller model: ATV28H***M2U ATV28H***N4U	200 to 240V 380 to 500 V	230 V 400 V if bFr = 50 460 V if bFr = 60
- Fr 5	Nominal motor frequency marked on the rating plate.	40 to 400 Hz	50 / 60Hz acc. to bFr
- t Un	Auto-tuning Only active for V/F ratios: n and nLd (Uft parameter) - no: (factory parameters of standard IEC motors) - donE (auto-tuning already done): use the parameters of the auto-tune which has already been done - YES: starts auto-tuning When auto-tuning is completed, rdY is displayed. On returning to tUn, donE is displayed. If the fault tnF appears, check that the motor is connected correctly. If the connection is correct, the motor is not suitable: use the L or the P ratio (Uft parameter). Caution: Auto-tuning operation will only be performed if no command has been activated. When a "freewheel" or "fast stop" function is assigned to a logic input, this input must be set to 1 (active at 0).	no-donE-YES	no
- t Fr	Maximum output frequency	40 to 400 Hz	60 / 72 Hz (1.2 x bFr)



Drive Menu **drC-** (continued)

Code	Assignment	Adjustment range	Factory setting
- <b>U F t</b>	Selection of the type of voltage / frequency ratio - L: constant torque for motors connected in parallel or special motors - P: variable torque - n: sensorless flux vector control for constant torque applications - nLd: energy saving, for variable torque applications	L - P - n - nLd	n
- <b>b r R</b>	Activating this function automatically increases the deceleration time, if this has been set at too low a value for the inertia of the load, thus avoiding the controller going into ObF fault. no: function inactive. YES: function active. This function may not be compatible with position control on a ramp or with the use of a braking resistor.	no - YES	YES
- <b>F r t</b>	Ramp switching frequency When the output frequency becomes greater than Frt, the ramp times taken into account are AC2 and dE2. When Frt = 0, the function is inactive. This parameter does not appear when a logic input is assigned to the ramp switching function rP2.	0 to HSP	0 Hz
- <b>5 F r</b>	Switching frequency The switching frequency can be adjusted to reduce the noise generated by the motor. Above 4 kHz, the drive controller output current must be derated: • up to 12 kHz: derated by 10% • above 12 kHz: derated by 20%.	2 to 15 kHz	4.0
- <b>n r d</b>	This function randomly modulates the switching frequency to reduce the motor noise. no: function inactive. YES: function active.	no - YES	YES

Parameter can be adjusted during operation.

Drive Menu **d r C -** (continued)

Code	Assignment	Adjustment range	Factory setting
- <b>A t r</b>	Automatic restart, after locking on a fault, if the fault has disappeared and the other operating conditions permit the restart. The restart is performed by a series of automatic attempts separated by increasingly longer waiting periods: 1 s, 5 s, 10 s, then 1 min for the following attempts. If the restart has not taken place after 6 min, the procedure is aborted and the drive controller remains locked until it is powered down then powered up. The following faults permit this function: OHF, OLF, USF, ObF, OSF, PHF, OPF, SLF. The drive controller fault relay remains activated when this function is active. The speed reference and the operating direction must be maintained. This function can only be used in 2-wire control (tCC = 2C). - no: Function inactive - YES: Function active - USF: Function only active for the USF fault	no - YES - USF	no
- <b>D P L</b>	Enables the motor phase failure fault. (Inhibition of the fault when a switch is used between the drive controller and the motor: no). no: function inactive. YES: function active.	no - YES	YES
- <b>I P L</b>	Enables the line supply phase failure fault. no: function inactive. YES: function active. This parameter does not exist on the ATV28HU09M2U, U18M2U, U29M2U and U41M2U for a single phase line supply. The fault is only detected when the motor is on-load (around 0.7 times the nominal power). At low load, single phase operation does not cause damage.	no - YES	YES
- <b>S t P</b>	Controlled stop on loss of line supply: Controls the stopping of the motor when there is a loss of line supply, following a ramp which automatically adapts according to the kinetic energy restored. no: function inactive. YES: function active.	no - YES	no

Drive Menu **d r L -** (continued)

Code	Assignment	Adjustment range	Factory setting
- F L r	Enables a smooth restart after the following events: - loss of line supply or power off - fault reset or automatic restart - freewheel stop or injection stop with logic input no: function inactive. YES: function active.	no - YES	no
- d r n	Lowens the tripping threshold of the USF fault in order to operate on a line supply with 40% voltage drops. no: function inactive. YES: function active: <i>NOTE: A line choke must be used. The performance of the drive controller may no longer be within specification when operating at undervoltage.</i>	no - YES	no
- 5 d 5	Scale factor for the display parameter SPd (-SUP menu), used to scale a value in proportion to the output frequency, the machine speed or the motor speed. For example: 4-pole motor, 1500 rpm at 50 Hz: -SdS = 30 -SPd =1500 at 50 Hz	1 to 200	30
- F L 5	Return to factory settings no: no YES: the next display will be InIt then bFr (start of the menus)	no - YES	no

 Parameter can be adjusted during operation.

I/O Menu **I - 0 -**

The parameters can only be modified when the drive controller is stopped and no run command is present. The functions are defined in "Configurable Logic and Analog I/O Functions" on page 29.

**⚠ WARNING**

**UNINTENTIONAL EQUIPMENT OPERATION**

Verify that tCC is set for the desired configuration before activating the drive controller.

**Failure to follow this instruction can result in death, serious injury, or equipment damage.**

Code	Assignment	Factory setting
-tCC	<p>Configuration of terminal block control: 2-wire or 3-wire control. 2C = 2-wire, 3C = 3-wire, OPt = presence of the local control option, operation is then identical to 3-wire control.</p> <p>2-wire control: The open or closed state of the input controls running or stopping. Wiring example: LI1: forward LIx: reverse</p> <p>3-wire control (momentary control): one pulse is all that is needed to control start-up. Wiring example: LI1: stop LI2: forward LIx: reverse</p> <p>Note: Changing the assignment of tCC returns the logic inputs to factory setting:</p> <ul style="list-style-type: none"> <li>• tCC = 2C: LI1: "Forward", cannot be reassigned LI3: PS2</li> <li>• tCC = 3C: LI1: Stop, cannot be reassigned LI3: rrS ("Reverse")</li> <li>• tCC = OPt: LI1: no, cannot be reassigned LI3: PS4</li> </ul>	2C

I/O Menu **I - D -** (continued)

Code	Assignment	Factory setting
- L 11	Parameter only accessible with the remote display module option: no - YES Enables control of the drive controller using the STOP/RESET, RUN and FWD/REV buttons on the display module. The speed reference is then given by parameter LFr in the SET- menu. Only the freewheel, fast stop and DC injection stop commands remain active on the terminal block. If the drive controller / display module link is broken, the drive controller locks on an SLF fault.	no
- L 12 - L 13 - L 14	Logic inputs no: not assigned rrS: reverse rotation (2 operating directions) rP2: ramp switching (1) JOG: "step by step" operation (1) PS2: 2 preset speeds PS4: 4 preset speeds (1) PS8: 8 preset speeds (1) nSt: freewheel stop. Function active when the input is powered down. dCI: DC injection braking IdC, peak limited at 0.5 lth after 5 seconds if the command is maintained FSt: fast stop. Function active when the input is powered down. FLO: forced local mode rSt: fault reset rFC: reference switching (when the input is powered down the speed reference is AIC/AI2 or that generated by the PI function if it is assigned) • When tCC = 3C, LI2 = "Forward", cannot be reassigned. • When a function is already assigned to another input it still appears, but its storage using <b>ENT</b> is inactive. • The 4 or 8 preset speeds must be configured in the following order of assignment: PS2 then PS4 then PS8. They must be cancelled in the reverse order (see "Configurable Logic and Analog I/O Functions" on page 29).	rrS  PS2 PS4
- R 1C	Analog input AIC / AI2 no: not assigned. SAI: summing with AI1. PII: PI regulator feedback, the PI references internal adjustment parameter rPI. [1] PIA: PI regulator feedback, the PI reference is automatically assigned to AI1. [1] • SAI can only be assigned if a logic input is assigned to rFC (reference switching). • PII and PIA cannot be assigned if a logic input is assigned to JOG or to PS2. • When a logic input LIx is assigned to rFC (reference switching) and AIC is assigned to PII or PIA, the speed reference is taken on AI1 if LIx = 0 and is the output of PI if LIx = 1.	SAI

[1] Assigning this function displays the corresponding settings in the SET- menu so that they can be adjusted.

I/O Menu **| - 0 -** (continued)

Code	Assignment	Factory setting
- CrL - CrH	<p>Minimum value on input AIC, adjustable from 0 to 20 mA. Maximum value on input AIC, adjustable from 4 to 20 mA. These two parameters are used to configure the input for 0–20 mA, 4–20 mA, 20–4 mA, etc.</p> <p>Frequency</p> <p>When the input used is AI2, these parameters remain proportionally active: 4 mA → 2 V 20 mA → 10 V For 20–4 mA, CrH must be less than CrL. For a 0–10 V input, configure CrL at 0 and CrH at 20.</p>	4 mA 20 mA
- r0	<p>Analog output no: not assigned. OCr: motor current. 20 mA corresponds to twice the nominal motor thermal current I<sub>th</sub>. rFr: motor frequency. 20 mA corresponds to the maximum frequency tFr. OLO: motor torque. 20 mA corresponds to twice the nominal motor torque. OPr: power supplied by the drive controller. 20 mA corresponds to twice the nominal motor power.</p>	rFr
- r0L	<p>Analog output 0: 0–20 mA configuration 4: 4–20 mA configuration</p>	0

I/O Menu **I - 0 -** (continued)

Code	Assignment	Factory setting
- r 2	Relay R2 no: not assigned FtA: frequency threshold reached. The contact is closed when the motor frequency is greater than or equal to the threshold set by Ftd. <sup>[1]</sup> CtA: current threshold reached. The contact is closed when the motor current is greater than or equal to the threshold set by Ctd. <sup>[1]</sup> SrA: speed reference reached. The contact is closed when the motor frequency is greater than or equal to the speed reference. tSA: thermal threshold reached. The contact is closed when the motor thermal state is greater than or equal to the threshold set by ttd. <sup>[1]</sup>	SrA
- A d d	Address of the drive controller when it is controlled via the serial link. Adjustable from 1 to 31.	1
- b d r	Serial link transmission speed: 9.6 = 9600 bits / s or 19.2 = 19200 bits / s Modification of this parameter is only taken into account after the drive controller has been powered down, then powered up.	19.2

[1] Assigning this function displays the corresponding settings in the SEt- menu so that they can be adjusted.

**Display Menu** SUP-

The Display menu allows you to choose the parameter to be displayed during operation and to view the last fault, drive controller software version, and access code.

The display chosen is saved by:

Pressing the ENT key once: the choice is temporary, it will be cleared at the next power up.

Pressing the ENT key twice: the choice is permanent. The second press on ENT exits the SUP- menu.

The following parameters can be accessed, with the drive controller stopped or running.

Code	Parameter	Unit
- F r H	Display the frequency reference	Hz
- r F r	Display the output frequency applied to the motor	Hz
- S P d	Display the value calculated by the drive controller (rFr x SdS)	-
- L C r	Display the motor current	A
- P P r	Display the power supplied by the motor, estimated by the drive controller. 100% corresponds to the nominal drive controller power.	%
- U L n	Display the line voltage	V
- t H r	Display the motor thermal state: 100% corresponds to the nominal thermal state. Above 118%, the drive controller triggers an OLF fault (motor overload).	%
- t H d	Display the drive controller thermal state: 100% corresponds to the nominal thermal state. Above 118%, the drive controller triggers an OHF fault (drive overheated). It can be reset below 70%.	%
- L F t	View the last fault which appeared. If there has been no fault, the display shows: noF.	-
- C P U	drive controller software version	-
- C O d	Parameter which can only be seen and accessed using a remote display module option or PC software. See pages 59 and 60. Access code: 0 to 9999. Value 0 (factory setting) does not prevent access. All other values lock access to the SET-, drC- and I-O- menus. To lock access to the drive controller, the code can be incremented using (▲ ▼) then saved using (ENT). To access the menus on a drive controller which is locked by a code, the code can be incremented using (▲ ▼) and confirmed with (ENT): • When the correct access code is displayed, it flashes, and code 0 can then be configured in order to access the menus. • When an incorrect code is displayed, the drive controller returns to the initial display (rdY).	-



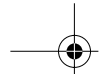

Display Menu **SUP -** (continued)

Code	Parameter
	Display of drive controller status: the operating phase of the motor or a fault.
	- Init: Initialization sequence
	- rdY: drive controller ready
----	- 43.0: Display of the frequency reference
	- dcb: DC injection braking in progress
	- rtrY: Automatic restart in progress
	- nSt: Freewheel stop command
	- FSt: Fast stop command

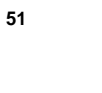
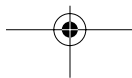

**CONFIGURATION TABLES**

Use the following tables to record your drive controller information and settings.

Drive controller ATV28H: \_\_\_\_\_

Optional customer identification no.: \_\_\_\_\_

Software version (CPU parameter in the SUP menu): \_\_\_\_\_

Optional access code: \_\_\_\_\_

Local control option no  yes

Menu **SEt -** (Settings)

Code	Factory setting	Customer setting	Code	Factory setting	Customer setting
-rPI	0.0 %	Control	-rDE	For	Control
-RCC	3.0 s	s	-dEC	3.0 s	s
-RCP	5.0 s	s	-dEP	5.0 s	s
-LSP	0.0 Hz	Hz	-HSP	Hz	Hz
-LEH	A	A	-UFR	20 %	%
-SLP	Hz	Hz	-FLG	33 %	%
-IdC	A	A	-tdC	0.5 s	s
-JPF	0 Hz	Hz	-JOG	10 Hz	Hz
-rPG	1		-rIG	1 /s	/s
-Fb5	1		-PIC	no	
-SP2	10 Hz	Hz	-SP3	15 Hz	Hz
-SP4	20 Hz	Hz	-SP5	25 Hz	Hz
-SP6	30 Hz	Hz	-SP7	35 Hz	Hz
-Ftd	Hz	Hz	-CLd	A	A
-ttd	100 %	%	-tL5	0.0 s	s

 The parameters in shaded boxes appear if the corresponding functions have been configured in the drC- or I-O- menus.

Menu **I - O -** (Inputs/Outputs)

Code	Factory setting	Customer setting	Code	Factory setting	Customer setting
-tCC	2C		-L12	rrS	
-L13	PS2		-L14	PS4	
-R1C	SAI		-CrL	4 mA	mA
-CrH	20 mA	mA	-RD	rFr	
-RQe	0 mA	mA	-r2	SrA	
-Rdd	1		-bdr	19.2	

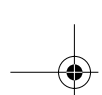

Menu **d r C -** (Drive)

Code	Factory setting	Customer setting	Code	Factory setting	Customer setting
-U <sub>n</sub> 5	V	V	-F <sub>r</sub> 5	Hz	Hz
-tU <sub>n</sub>	no		-tF <sub>r</sub>	Hz	Hz
-UF <sub>t</sub>	no		-brA	YES	
-F <sub>r</sub> t	0 Hz	Hz	-SF <sub>r</sub>	4.0 kHz	kHz
-nr <sub>d</sub>	YES		-R <sub>t</sub> r	no	
-DPL	YES		-IPL	YES	
-StP	no		-FL <sub>r</sub>	no	
-dr <sub>n</sub>	no		-Sd5	30	

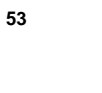
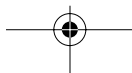
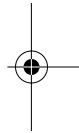
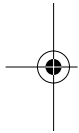

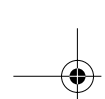

## MAINTENANCE AND TROUBLESHOOTING

Read the following safety statements before proceeding with any maintenance or troubleshooting procedures.

The following steps should be done at regular intervals:

- Check the condition and tightness of the connections.
- Make sure ventilation is effective and temperature around the drive controller remains at an acceptable level. The average lifetime of the fans is 3 to 5 years depending on the conditions of use.
- Remove dust and debris from the drive controller, if necessary.

### Precautions

Table 13 on page 56 lists the codes for the faults which can be automatically reset, the probable causes of the faults, and the associated corrective action. Table 14 on page 57 lists the fault codes for the faults which are not automatically resettable (thus requiring reset by cycling power) along with the probable causes of the faults and associated corrective action. When taking corrective action, follow the procedures outlined on page 55.

## **⚠ DANGER**

### **HAZARDOUS VOLTAGE**

Read and understand these procedures before servicing ATV28 drive controllers. Installation, adjustment, and maintenance of these drive controllers must be performed by qualified personnel.

**Failure to follow this instruction will result in death or serious injury.**

The following procedures are intended for use by qualified electrical maintenance personnel and should not be viewed as sufficient instruction for those who are not otherwise qualified to operate, service, or maintain the equipment discussed.

If a fault is detected, the drive controller trips and the fault relay deenergizes.

After verifying that there is no voltage present on the DC bus (see "Bus Voltage Measurement Procedure" on page 16), check the supply voltage and the peripheral components.

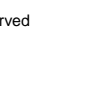

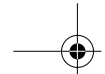

### Procedure 1: Checking the Supply Voltage

To measure the input line voltage:

1. Remove all input line voltage.
2. Attach meter leads to L1 & L2. Set voltmeter to the 600 Vac scale.
3. Reapply power and check for correct line voltage, per drive controller nameplate rating.
4. Remove power and repeat procedure for L2 & L3, and L1 & L3 if wired for three phase.
5. When all phases have been measured, remove power. Remove leads and reinstall covers.

### Procedure 2: Checking the Peripheral Equipment

The following equipment may need to be checked. Follow the manufacturers' procedures when checking this equipment.

1. A protective device such as fuses or a circuit breaker may have tripped.
2. A switching device such as a contactor may not be closing at the correct time.
3. Conductors may require repair or replacement.
4. Connection cables to the motor or high resistance connections to ground may need to be checked. Follow NEMA standard procedure WC-53.
5. Motor insulation may need to be checked. Follow NEMA standard procedure MG-1. Do not apply high voltage to U, V, or W. Do not connect high potential dielectric test equipment or an insulation resistance tester to the drive controller since the test voltages used may damage the drive controller. Always disconnect the drive controller from the conductors or motor while performing such tests.

## **⚠ CAUTION**

### **EQUIPMENT DAMAGE HAZARD**

- Do not perform high potential dielectric tests on circuits while the circuits are connected to the drive controller.
- Any circuit requiring high potential dielectric tests must be disconnected from the drive controller prior to performing the test.

**Failure to follow this instruction can result in injury or equipment damage.**



## FAULT STORAGE

The first fault detected is saved and displayed on the keypad screen if power is maintained. The drive trips, and the fault relay opens.

To reset the fault:

- Remove power from the drive controller.
- Before switching power back on, identify and correct the cause of the fault.
- Restore power. This will reset the fault if it has been corrected.

In certain cases, if automatic restart has been enabled, the drive can be automatically restarted after the cause of the fault has disappeared. Refer to the Level 2 parameters.

## FAULT CODES

**Table 13: Resettable Faults with Automatic Restart**

Fault	Probable cause	Corrective Action
- <b>OHF</b> drive controller overload	- I <sup>2</sup> t too high or - drive controller temperature too high	- Check the motor load, the drive controller ventilation and the environment. Wait for the controller to cool before restarting.
- <b>OLF</b> motor overload	- tripped by I <sup>2</sup> t motor being too high - thermal trip due to prolonged motor overload	- Check the setting of the motor thermal protection, check the motor load. Wait for the controller to cool before restarting.
- <b>OSF</b> overvoltage in steady state or during acceleration	- line voltage too high	- Check the line voltage.
- <b>USF</b> undervoltage	- input voltage too low - transient voltage dip - damaged load resistor	- Check the voltage and the voltage parameter. - Reset. - Send the drive controller to be checked/repared.
- <b>OBF</b> overvoltage during deceleration	- braking too sudden or driving load	- Increase the deceleration time. - Install a braking resistor if necessary. - Activate the brA function if it is compatible with the application.
- <b>PHF</b> motor phase phase failure	- drive controller incorrectly supplied or a fuse blown - transient phase fault - 3-phase ATV28 used on a single phase line supply	- Check the power connection and the fuses. - Reset - Use a 3-phase line supply.
- <b>DPF</b> motor phase failure	- loss of a phase at the speed controller output	- Check the connections from the drive controller to the motor.
- <b>SLF</b> serial link failure	- incorrect connection on the drive controller connector	- Check the serial link connection on the speed controller connector.

**Table 14: Non-Automatically Resettable Faults**

Fault	Probable cause	Corrective Action
- <i>OCF</i> overcurrent	- ramp too short - inertia or load too high - mechanical blocking	- Check the settings. - Check the motor/drive controller/load sizing. - Check the state of the mechanism.
- <i>SCF</i> motor short-circuit	- short-circuit or grounding at the drive controller output	- Check the cables connecting the drive controller to the motor, and the insulation of the motor.
- <i>INF</i> internal fault	- internal fault	- Check the environment (electromagnetic compatibility). - Check that the "local control" option has not been connected or disconnected with the controller powered up. - Send the drive controller to be checked/repaired.
- <i>LnF</i> auto-tuning fault	- special motor or motor whose power is not suitable for the drive controller	- Use the L or the P ratio.
- <i>EEF</i> internal fault	- internal fault	- Send the drive controller to be checked/repaired.

*NOTE: The cause of the fault must be corrected before resetting by powering down and then powering up.*

**Drive Controller Does Not Start, No Fault Displayed**

- The assignment of the "Fast stop" or "Freewheel stop" functions will prevent the controller from starting if the corresponding logic inputs are not powered up. The ATV28 then displays "nSt" in freewheel stop mode and "FSt" in fast stop mode. This is normal since these functions are active at zero so that the controller will be stopped safely if there is a wire break.
- On power-up or a manual fault reset or after a stop command, the motor can only be powered once the "forward", "reverse", and "DC injection stop" commands have been reset. If they have not been reset, the drive controller will display "rdY" but will not start. If the automatic restart function is configured (parameter Atr in the drC menu), these commands are taken into account without a reset being necessary.

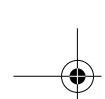

## OPTIONS

### Start/Stop/Potentiometer Kit—VW3A28100

This option consists of a reference potentiometer and provides access to 2 additional buttons on the drive controller (see documentation provided with the option):

- RUN button: controls the switching on of the motor. The direction of operation is determined by parameter rOt in the settings menu SEt-.
- STOP/RESET button: controls the stopping of the motor and the clearing (resetting) of any faults. The first press on the button stops the motor, and if DC injection standstill braking is configured, a second press stops this braking.

The reference given by the reference potentiometer is summed with analog input AI1. Installing this option requires special factory setting of certain functions (see page 23):

- I/O:
  - tCC = OPt not reassignable
  - LI1 = no not reassignable
  - LI2 = PS2 reassignable
  - LI3 = PS4 reassignable
  - LI4 = PS8 reassignable
- Drive: Atr = no, only reassignable at YES

This option cannot be removed once it has been fitted.  
The option must be connected with the drive controller powered down, otherwise it will trip on an InF fault.

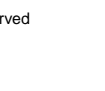



### Remote Display Mounting Option—VW3A28101

This module can be mounted on the door of the wall-mounted or floor-standing enclosure. It comes with a cable and connectors, which is connected to the drive controller serial link (see the instruction sheet supplied with the display module). It has the same display and the same programming buttons as the ALTIVAR 28 drive controller with the addition of a switch to lock access to the menus and three buttons for controlling the drive controller:

- FWD/RV: reversal of the direction of rotation
- RUN: motor run command
- STOP/RESET: motor stop command or fault reset. The first press on the button stops the motor, and if DC injection standstill braking is configured, a second press stops this braking.

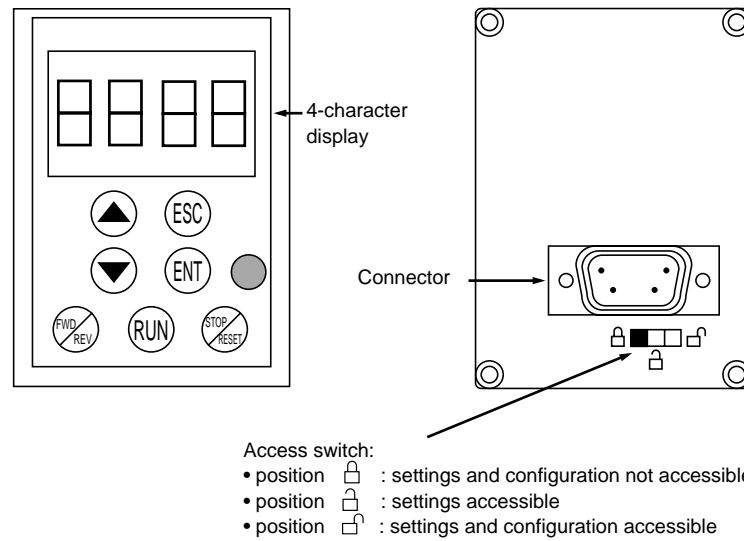

Figure 17: Keypad Remote Mounting Kit

### Conduit Entry Kit

This option is a conduit box that allows multiple (three or more) conduit entries. It attaches to the bottom of the drive controller. See the documentation supplied with the option for installation instructions. Without removal of the grey tape on the top of the drive controller and with the addition of this kit, the drive controller complies with NEMA UL Type 1 standards.

**Table 15: Conduit Entry Kits**

Kit Catalog No.	Drive Controller Outline	Drive Controller Catalog No. ATV28H*****
VW3A28811A	1	U09M2U, U18M2U
VW3A28812A	2	U29M2U, U18N4U, U29N4U
VW3A28813A	3	U41N4U, U54N4U, U72N4U, U41M2U, U54M2U, U72M2U
VW3A28814	4	U90M2U, D12M2U, D12N4U, U90N4U
VW3A28815	5	D16N4U, D23N4U

### DIN Rail Kit—VW3A28851

The DIN rail kit is for use with drive controllers ATV28HU09M2U and U18M2U. It allows the smaller drive controllers to be din rail mounted.

### PC Software Kit—VW3A8106

This option allows you to configure drive parameters from a PC. See the documentation supplied with the option for installation instructions.

### MODBUS® Kit—VW3A28301U

This option allows multiple ALTIVAR 28 drive controllers to be connected to the MODBUS network. The controllers can receive and respond to data messages. This data exchange enables a network to access ATV28 functions such as

- Remote loading of configuration parameters
- Command and control
- Monitoring
- Diagnostics

Refer to instruction bulletin VVDED399092US supplied with the MODBUS kit.

### ATV18 Replacement Kit

This option provides brackets that allow an ATV28 drive controller to be secured to existing panel mounting holes for an ATV18 drive controller.

**Table 16: ATV18 Replacement Kits**

Kit Catalog No.	Drive Controller Outline	Drive Controller Catalog No. ATV28H*****
VW3A28821	1	U09M2U, U18M2U
VW3A28822	2	U29M2U, U18N4U, U29N4U
VW3A28823	3	U41N4U, U54N4U, U72N4U, U41M2U, U54M2U, U72M2U
VW3A28824	4	U90M2U, D12M2U, D12N4U, U90N4U
VW3A28825	5	D16N4U, D23N4U

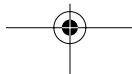
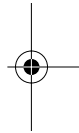
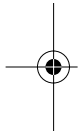
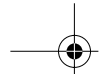

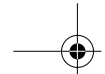

---

## Numerics

- 2-wire control 29
- 3-wire control 29

---

## A

- acceleration ramp 35
- adjust menu 39–41
- AIC 31
- altitude 4
- analog
  - input 31, 35
  - output 32
- auto/manual 32
- automatic restart 56

---

## B

- base frequency 35
- braking
  - dc injection 35
  - torque 4
- branch circuit connections 18
- bus voltage measurement 16–17

---

## C

- cable
  - length 19
  - panel 15
  - routing 15, 17
  - type 19
- capacitance 18
- clearances 7

- codes
  - fault 54
  - parameter 39–51
- condensation 11
- current
  - fault withstand. See current, short circuit
  - input 18
  - motor 32
  - motor thermal 35
  - nominal 35
  - transient 4
- current threshold attained 32

---

## D

- DC injection braking 30
- deceleration
  - ramp 35
  - ramp adaptation 35
- dimensions 5
- direction 29
- display menu 50–51
- drive menu 42–45

---

## E

- EMC 12
  - plate 14
- enclosure
  - IP54 9
  - sizing 9, 10
  - type 12 9
  - ventilation 11

---

## F

- factory settings 35
- fan 27
- fast stop 30
- fault
  - codes 54, 56
  - relay 27
  - reset 31, 54, 56
  - storage 56
- forced local 31
- freewheel stop 30
- frequency
  - base 35
  - input 4
  - loop gain 35
  - maximum 26
  - motor 32
  - nominal 26
  - output 4
  - resolution 4
  - switching 4, 35
  - threshold attained 32
- fuses 18, 25

---

## G

- grounding 19–20
  - multiple drives 20

---

## H

- high speed 35
- humidity 4



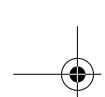

**I**

I/O menu 46–49  
inductance 19  
input  
  analog 35  
  frequency 4  
  logic 35  
  phases 4  
  voltage 4, 55  
inspection 1  
installation 6–11  
integral gain 32

**J**

jog 29

**K**

keypad display 36

**L**

labels 8  
line contactor 25  
logic  
  input 35  
  output 35  
low speed 35

**M**

maintenance 54  
maximum frequency 26  
menus

accessing 37  
adjust 39–41  
display 50–51  
drive 42–45  
I/O 46–49  
motor  
  current 32  
  frequency 32  
  thermal current 35  
  torque 32  
  voltage 35  
mounting 7  
  NEMA Type 12 (IP54) 11

**N**

noise suppressors 25  
nominal  
  current 35  
  frequency 26

**O**

options 58–61  
output  
  frequency 4  
  logic 35  
  phases 4  
  voltage 4  
  wiring 18  
overcurrent 18  
overspeed 26

**P**

parameters  
  accessing 38  
  codes 39–51

types 38  
peripheral equipment 55  
phases  
  input 4  
  output 4  
PI feedback 31  
pollution degree 4  
power 33  
power wiring 17  
preset speeds 30  
product range 1  
programming 34–38  
proportional gain 32  
protection 1, 4, 54  
  drive controller 4  
  motor 4, 28  
  thermal 28  
protective cover 7

**R**

ramp  
  acceleration 35  
  deceleration 35  
  switching 29  
reference  
  summing 31  
  switching 30  
relay 32, 35  
reset  
  fault 54, 56  
restart  
  automatic 56  
reverse operation 29

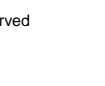

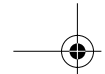

---

## S

speed reference attained 32  
stop  
    DC injection 30  
    fast 30  
    freewheel 30  
supply voltage 55  
switching  
    frequency 4, 35  
    reference 30

---

## W

weights 5  
wiring 15–24  
    branch circuit components  
    18  
    diagram 24  
    general practices 17  
    minimum inductance 19  
    output 18  
    power 17

---

## T

temperature 4, 9  
terminals  
    control 23  
    locations 15  
    power 21  
thermal  
    protection 27, 28  
    resistance 9, 10  
    state attained 32  
torque 26, 32  
    braking 4  
transient current 4

---

## V

ventilation 11, 54  
vibration 4  
voltage  
    input 4, 55  
    motor 35  
    output 4

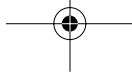

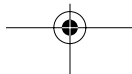
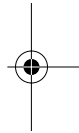
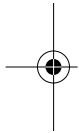





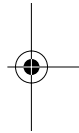
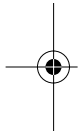

Square D Company  
8001 Hwy 64 East  
Knightdale, NC 27545 USA  
1-888-SquareD (1-888-778-2733)  
www.squared.com

Electrical equipment should be serviced only by qualified electrical maintenance personnel. No responsibility is assumed by Schneider Electric for any consequences arising out of the use of this material.

Bulletin No. VVDED399062US R5/00 Replaces VVDED399062US dated 2/00 © 2000 Schneider Electric All Rights Reserved.

