

MOTO-GPS

VOYAGER

USER'S MANUAL

A

TRAILTECH

COMPUTER

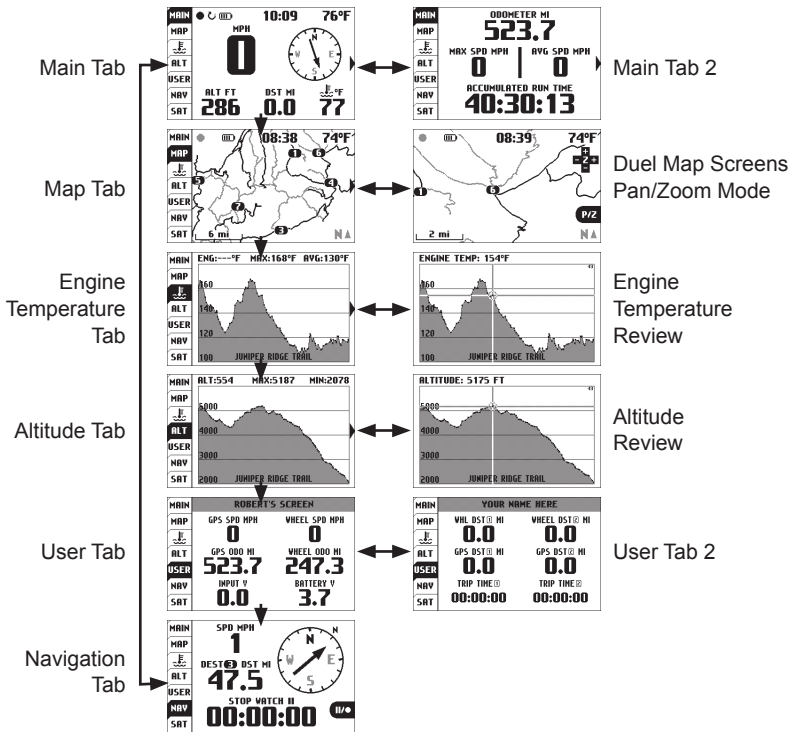

Use the navigation switch to move up and down between screens.

Quick-Start

UP

Navigate tab screens and menus.

LEFT

Cancel, back, or change screens.



RIGHT

Confirm, select, or change screens.

DOWN

Navigate tab screens and menus.

MENU/POWER

Enter or exit menu. Hold to power off.

BACK

Backs out of any screen or menu. Press 2-3 times to return to main tab.

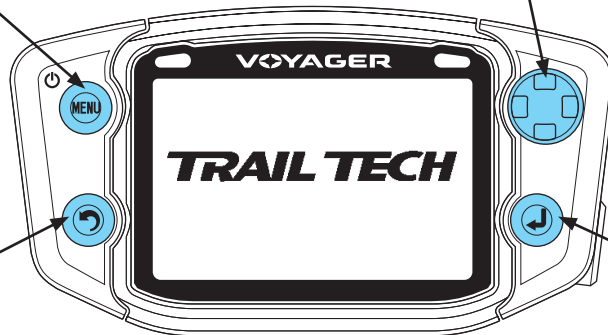

ENTER

Confirm changes or switch to next screen.

Introduction

VOYAGER

Trail Tech brings functionality and life to your motor vehicle with high quality and innovation. To ensure long and trouble-free operation, this User's Manual contains valuable information about how to operate and maintain your digital gauge properly.

Please read this manual carefully.

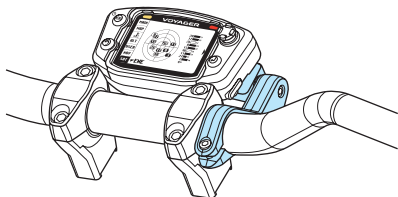

If you call to request service for your Voyager digital gauge, you need the date of purchase, dealer's name, address, and telephone number. Warranty service requires proof of purchase.

PURCHASE DATE _____

DEALER NAME _____

DEALER ADDRESS _____

DEALER PHONE _____

Keep this book and sales slip together for future reference.

Precautions

WARNING:

- In order to charge Voyager using a wall outlet, Trail Tech's wall charger (9000-ACA) is required. Attempting to charge Voyager directly off an outlet will result in failure of your Voyager Moto GPS.
- Read all instructions before using Voyager.
- Avoid contact with gasoline, degreasers or other chemical cleaners.
- Do not wash with pressure washer.
- When installing Voyager, disconnect the vehicle battery.
- When installing radiator hose temperature sensors, make sure it fits BEFORE cutting the radiator hose.
- Check gap between wheel sensor and magnet periodically to ensure correct measurements and reading on Voyager.
- Do not bend, twist, kink or abuse the sensor cables.
- Do not disassemble Voyager or its accessories.
- Do not operate Voyager while driving/riding.
- Do not rely on Voyager for operations requiring absolutely precise measurements of distance or direction. All GPS devices inherently contain some amount of error. Use the wheel sensor for the most precise data.

PAY ATTENTION TO THE TRAIL!

FAQ

1. Voyager will not turn on: The internal battery may need to be charged before use, connect to vehicle power or use the wall charger (wall charger sold separately.)

2. How long does the internal battery take to charge fully? No need to pre-charge; connect and ride. Voyager takes 3-8 hours to fully charge depending on charge mode.

3. How do I get the best reception? The internal antenna is designed for optimum reception potential. If Voyager is mounted with metal blocking the internal antenna, consider purchasing the external antenna (9000-EAA).

4. How do I mount Voyager to my machine? Vehicles with handlebars can use the included handlebar mounting hardware. There are also protective accessory mounts available, or utilize the two mounting holes in the back of Voyager to fix to a flat surface.

5. What kind of power does Voyager need for proper operation? Voyager is intended to work on regulated AC or DC motorcycle power systems. The DC input range is 12V to 65V. The AC input range is 12V RMS to 150V peak input. Voltages greater than 150V may damage Voyager. DC power systems with a failing vehicle battery may produce too low a system voltage (<11.5V) to allow for proper operation.

6. Voyager kits include physical sensors, magnets, and other cables. Why does the unit need this if it's a GPS? You can use Voyager handheld without any sensors connected. However, physically bolting Voyager to your vehicle provides many advantages over a conventional handheld GPS.

A. Power from the machine enables several integration features, such as extended run-time and maintenance-free charging.

B. The engine temperature sensor monitors

the health of your machine and enables two major features: engine temperature diagnostics and over-temp warning LEDs.

C. The ignition sensor tells Voyager when the engine is running. This enables logging of tracks only when engine is running and tachometer display features.

D. The wheel sensor can also control when to log, and provides a more accurate odometer than GPS.

7. Do I really need a wheel sensor? My other GPS unit gets along just fine without one. All speed/distance data can be gathered from either GPS or the wheel sensor. Voyager kits provide a wheel sensor for several reasons:

A. When using a wheel sensor, Voyager knows to stop logging when the vehicle stops moving. When you start rolling again, the wheel sensor tells Voyager which starts logging again (without a GPS induced lag.)

B. The wheel sensor will track distance regardless of GPS conditions. This is important under several circumstances:

a. GPS cannot tell the difference between a motorcycle moving under its own power or in the back of a truck.

b. The GPS signal can be lost, especially around metal structures or in tunnels. With no signal, speed and distance accuracy is lost.

c. GPS cannot see small changes in elevation (i.e. whoops and ruts.) Over time this will create significant odometer error.

d. GPS is accurate while travelling in straight lines at constant velocity. However, tight, fast corners will cause the GPS to skip over part of your path. Over time this will contribute to odometer error.

C. Trail Tech believes an accurate odometer and hour meter are critical features. To maintain this accuracy, kits are provided with a wheel sensor included.

8. Can Voyager use GPX files? GPX (GPS exchange format) is Voyager's native format. Import/export between the MicroSD and dozens of software programs and web services.

Frequently Asked Questions

9. My vehicle does not have a battery or a headlight. Can I run Voyager? Yes. Voyager can be connected to vehicle power even on a vehicle without a battery or lighting capability. Most motocross machines manufactured before 2009 do not have batteries or any type of regulated power. Note that the peak AC input range for Voyager is 150V. For motocross bikes producing in excess of 150V, it would be best to run Voyager on its internal lithium battery alone. Purchase the accessory wall charger to charge the internal lithium battery before riding. Contact Trail Tech for more information on testing your bike's peak AC output.

If the machine is within the acceptable range, follow Trail Tech's instructions for connect to vehicle power (e.g. at the CDI input.)

10. Can Voyager be turned on and off manually? Yes. Hold down the upper left button to power Voyager off. Note that Voyager has two types of sleep mode.

The first sleep mode shows the clock on the screen. Some features are turned off to conserve power, but Voyager is still alert to come back on quickly when you are ready to continue riding.

The second sleep mode turns Voyager off completely to conserve as much power as possible. You can alter the sleep mode timers in *Set > Power Settings > Power-Save >*.

11. How do I run Voyager without connecting it to a vehicle? Voyager provides an easy way to change unit settings to accommodate a wide variety of user needs. There are few menu options to change when Voyager is used without external power: See the "Sensor Notes" section for details on the settings that need to change in order to use Voyager without connecting one or more of its sensors to a vehicle.

Specifications

Function	Display	Range
Speed	SPD	0-999 MPH
Distance	DST	0-250,000 mi
Altitude	ALT	59,000 ft
Temperature	ENG	0-260°C (32-499 °F)
Accum. Run Time	CLOCK	0-1,000,000 hr
GPS Sample Rate	TIME	1-5 sec
	DISTANCE	1-15 m

Power	Description
External Power Input	12V RMS-150V Peak AC 12V-60V DC
Internal Battery	3.7V 900 mAh Li-Ion
Power Wire	Red/Black Power Wire
Battery Life (typical use)	11 hours
Battery Life (100% backlight)	6 hours
Battery Charge Time	3-8 hours

Feature	Description
Geodetic Datum	WGS84
GPS Chipset	MediaTek MT3329
Joystick	5-Position High-Tactile
Wheel Sensor	Non-contact Magnet Sensor
Temperature Sensors	External Ambient and Engine Thermistor Sensors
Backlight	LED Group
Screen	400x240 WQVGA LCD 68.6mm (2.7") Diagonal 58.8x35.3mm (2.3x1.4")
Product Dimensions	113x62x28.2mm (4.5x2.5x1.1") WxHxD
Product Weight	6.1 oz. (172g) (0.38lbs.)
Operation Temperature	0-60°C (32-140°F)
Storage Temperature	-20-80°C (0-175°F)
Critical Engine Enviro.	Amber/Red LED Alerts
Max Waypoints	300 waypoints
Max Track Points	72,500 points
Max Route Points	72,500 points
Max Tracks/Routes	300 each

Physical Features

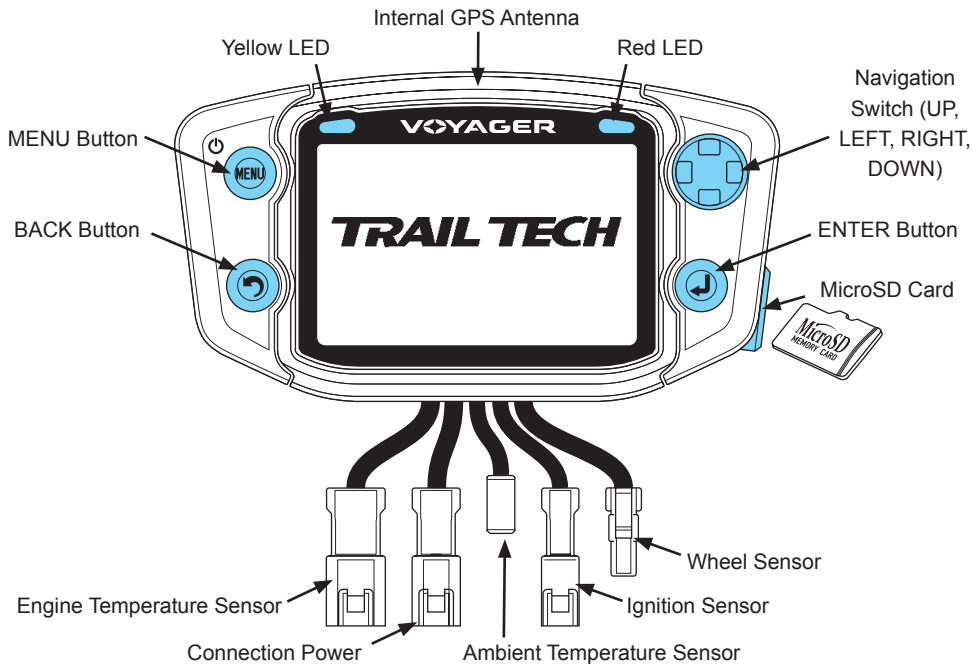

Internal Battery:

The battery is **pre-installed**. Voyager requires the internal Li-Ion battery to be installed for operation.

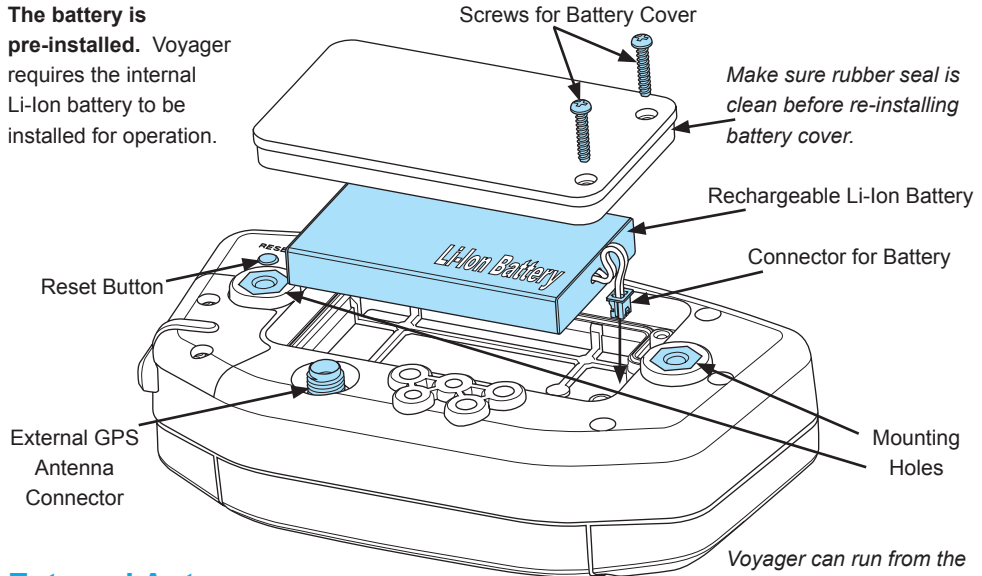

External Antenna:

An external GPS antenna accessory will get better reception if the mounting location interferes with the reception of the internal antenna. Sold separately (9000-EAA).

Voyager can run from the internal battery, but it is recommended to connect to an external power source.

Bar Mounting:

The included bar clamps fit 7/8" through 1-1/8" handlebars.

Place the nuts and bolts as shown.

Adjust angle as required.

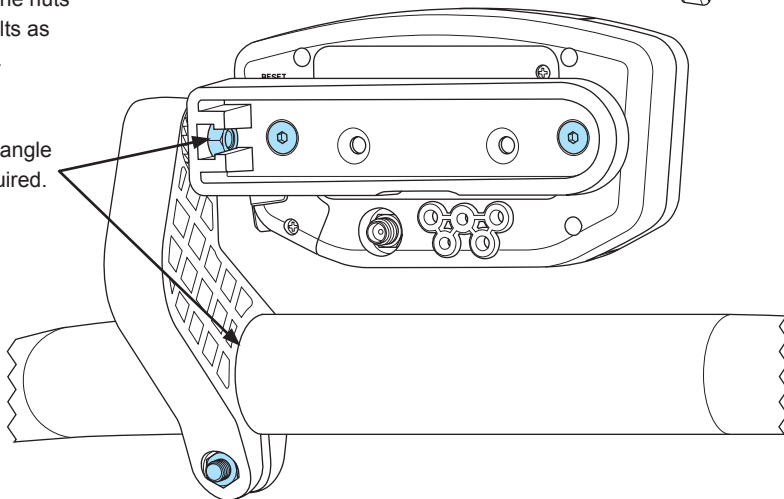
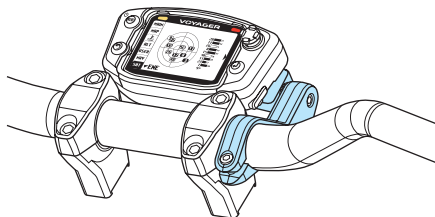

Template:

The template on this page is actual size. Use it to drill mounting holes, or other custom mount options.

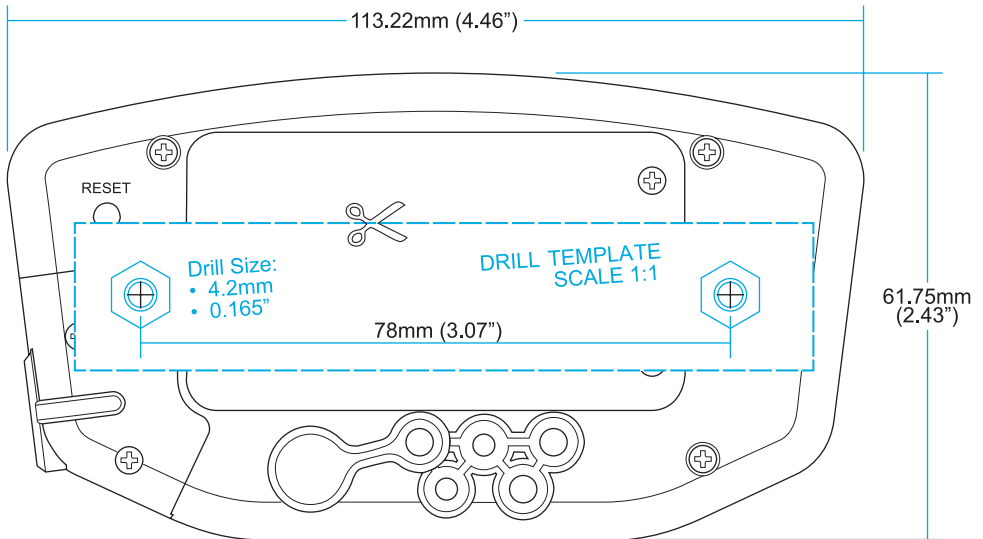

Use the included M4x16 bolts to mount to any flat surface. *If other than provided screws are used, make sure they are not too long for mounting holes or they will damage internal components of Voyager.*

MicroSD Memory Cards:

Insert any MicroSD card into the side of Voyager. Make sure the card slot cover is properly seated to maintain waterproof properties.

An installed MicroSD card enables import/export of tracks.

After exporting a track to the MicroSD card, insert it into your computer's card reader to save the track or view it in Ride Leader.

Tracks are saved in GPX format and viewable in Google Earth, or other compatible programs with that format.

Tracks saved on your computer can be placed on the MicroSD memory card, then imported onto Voyager for viewing and route following. This is a great way to share tracks with your friends, or for pre-planning your own trips.

Must be formatted FAT. (NTFS not supported.)

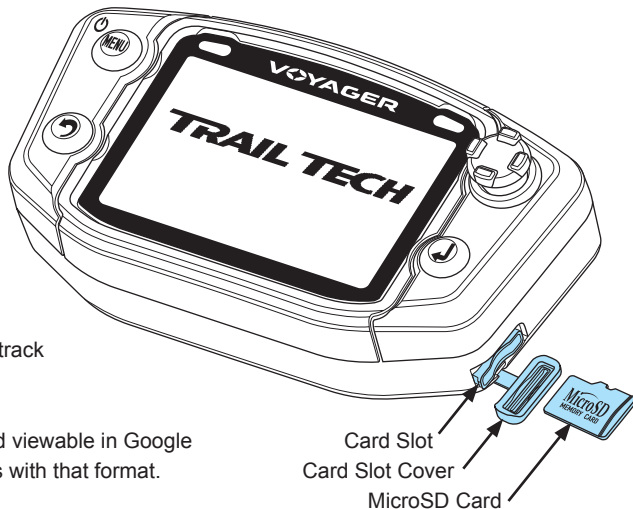

Replacement SD Card
(9000-MSPIG)

Vehicle Power:

Connect the power cable directly to the vehicle's 12 volt battery. A 0.5A fuse (not provided) should be used. Alternately tap into the electrical system (preferably not interrupted by the key switch.) Voyager is polarity independent.

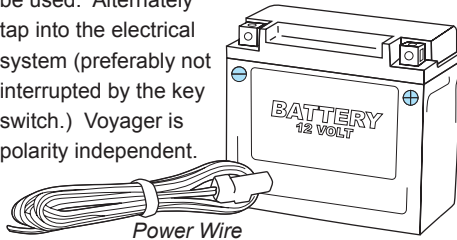

Ignition Sensor:

The ignition sensor detects the on/off status of the engine. When the engine is shut off, Voyager will know to go to sleep for power conservation.

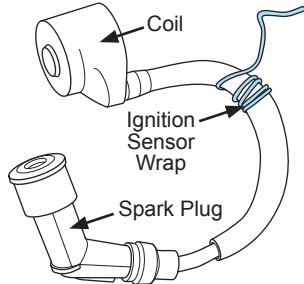

Temperature Sensors:

See model-specific instructions for mounting procedure.

Cylinder Head Sensor:

For air-cooled machines.

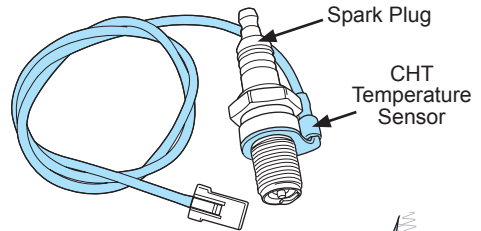

Radiator Hose

Sensor:
In-line in radiator hose for water-cooled machines.

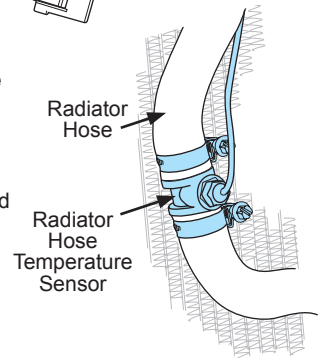

Sensor Notes:

If you plan to not use one of the vehicle sensors, settings in Voyager should be changed to account for it:

1. No Wheel Sensor:

Voyager defaults to use the wheel sensor to gather speed and distance measurements. If not using the wheel sensor, Voyager should instead use GPS to gather the speed and distance measurements.

[Set > Vehicle Sensors > Wheel Sensor: Disabled](#)

2. No Engine Sensor / No Wheel Sensor

By default Voyager will not log unless it detects signal from the wheel and/or the engine sensor. If the sensors aren't installed, you need to enable logging regardless of connected sensors.

[Set > Vehicle Sensors > Wheel Sensor: Disabled](#)
[Set > Vehicle Sensors > Engine Sensor: Disabled](#)

3. No Vehicle Power Connection

Voyager charges its internal battery only when

the vehicle is running to avoid draining the vehicle battery. If no vehicle power, switch charge mode so that it always charges (even in sleep mode.) This enables use of the wall charger (sold separately 9000-ACA.)

[Set > Power Settings > Battery Charger > Charge Mode: Wall Plug](#)

Voyager automatically stops logging when it enters sleep mode. Change these settings to prevent Voyager from going into sleep mode. (Remember to hold the MENU button for 3 seconds to turn Voyager off.)

[Set > Power Settings > Power-save > Sleep \(Battery\): Always On](#)
[Set > Power Settings > Power-save > Turn Off: Always On](#)

Voyager can stay on for twice as long if you disable the backlight. In typical use, you can expect 9-14 hours of use with no backlight, or 5-10 hours with the backlight enabled.

[Set > Power Settings > Backlight > Brightness > OFF](#)

ATV Wheel Sensor Installation:

While not required, using the wheel sensor is recommended. It will collect more accurate speed and distance data than GPS. Due to limitations in GPS technology, physical sensors perform with more precision. GPS sometimes loses track of your movements, while the wheel sensor always knows when you are moving.

Two halves are required for the wheel sensor to function:

1. A magnet, on the spinning part of the wheel.
2. A speed sensor, on the non-spinning part of the wheel.

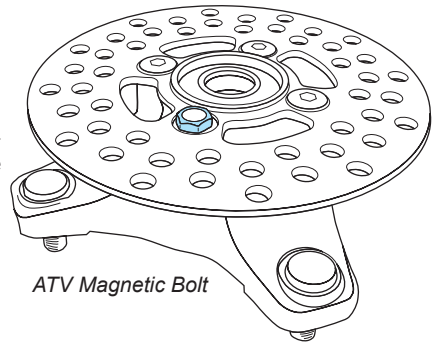
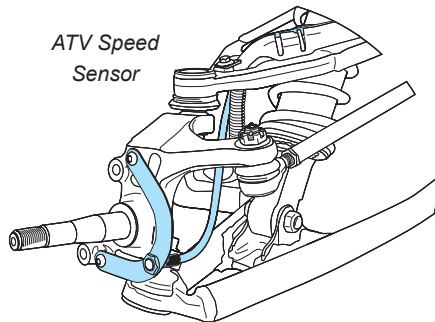

The magnet spins around tripping the sensor switch each time—giving Voyager speed, distance and time data to compare with the GPS data.

The magnet is installed on the brake rotor because it spins with the wheel. The provided magnetic bolt replaces a stock rotor bolt. If that will not work, glue the spare magnet in a hole on the brake rotor. (JB Weld or a similar slow-cure epoxy works well.)

After the magnet is in, the sensor is placed on a non-spinning part the wheel, rotor shield, or bracket.

Motorcycle Wheel Sensor Installation:

Motorcycle wheel sensors, like ATVs, need a magnet placed on the spinning part of the wheel and the sensor installed to a non-spinning area.

The magnet gets bolted or glued to the brake rotor. The wheel sensor should be cable-tied to the brake line, then attached to the brake caliper.

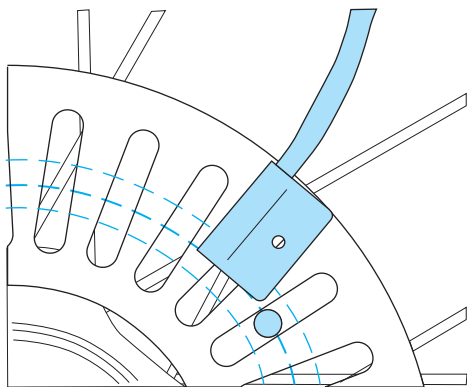

Magnet Rotation Path

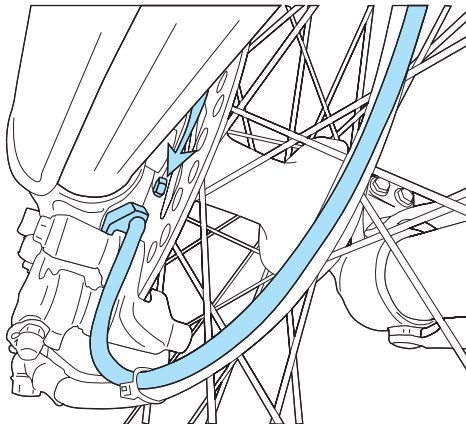

Magnet Passing Under Sensor

Voyager can tell precisely how far and fast it's traveled by how many times the magnet passes the sensor.

Many Motorcycles and ATVs have special installation procedures. Refer to the model-specific instructions for more information.

Measure Wheel Size:

Knowing your exact wheel size is critical for the wheel sensor to calculate correct speed and distance data. The more accurate the wheel size, the better Voyager performs.

When comparing calibration to GPS data, use a long straight section of road. GPS has trouble with tight fast corners and small vertical movements (causing comparison inaccuracy.)

Method 1: Ruler

Find the circumference of front wheel by measuring its diameter in millimeters. Multiply the Wheel Diameter by 3.14. The result is your wheel size.

Method 2: Rolling

On a flat surface, mark the tire sidewall and the ground with a marking pen. Roll the wheel until the mark on the tire completes one revolution and is back on the ground. Mark the ground at this location. Measure the distance between the marks on the ground in millimeters (multiply inches by 25.4 to convert to mm). Use this number for your wheel size. For accuracy, the rider's weight should be on the bike when making the measurement.

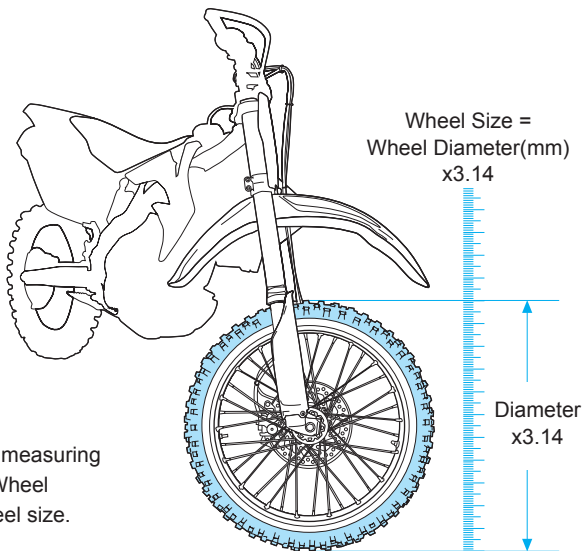

User Interface

Voyager has 7 tabbed screens: Main, Map, Engine Temperature, Altitude, User Definable, Navigation, and Satellites. Switch screens using the joystick. You can always return to the Main tab screen by pressing the BACK button, or press the MENU button to change options.

Main Tab:

The Main Tab displays current trip data being received from the environment.

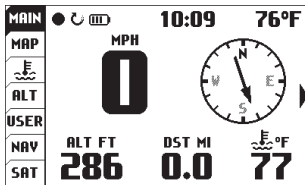

Main Tab 1

It displays current speed, altitude, engine temperature, ambient temperature, time of day, compass direction, and trip distance. The top left icons are logging record/pause, engine running and battery level. You can select metric or English units in the *Set>Unit Settings>* menu.

Main Tab Screen 2:

There are two screens in the Main Tab, hinted by the side arrow: ▶. Using the joystick, press right or left to move to the Main 2 screen.

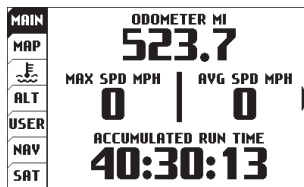

Main Tab 2

The Main 2 screen displays permanent odometer and accumulated (permanent) run time. It also displays maximum and average speed for the current trip.

Map Tab:

The Map Tab shows where you are. The arrow shows the direction you are travelling, leaving a trail of “bread crumbs” behind it.

Each time a GPS sample is taken, the arrow moves and a new dot is placed on

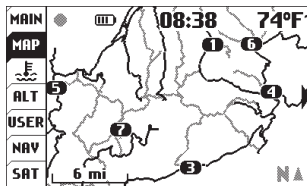

Map Tab

the line. Waypoints are also shown on the map and labels can be added to the map. If you have uploaded routes to Voyager, they will be displayed in gray so that you can follow along.

Pause data logging by pressing MENU twice and toggling the LOG TRACK option.

2 Map Screens

To toggle between the two map screens press LEFT or RIGHT when on the Map tab. Each Map is indicated by either the number 1 or 2 just above the arrow on the right and both are independent of each other. Both of these maps can be set to different zoom levels.

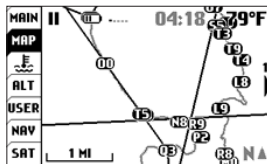

Map Screen 1



Map Screen 2

Map Pan/Zoom Mode

There are two map operating modes, regular and pan/zoom mode. The regular mode shows the map and UP/DOWN will scroll to the Main Tab or Engine Temperature Tab. Pan/zoom mode allows you to examine the map in greater detail. To enter pan/zoom mode, press RIGHT or LEFT from the Map tab. (In pan/zoom mode, auto-center and auto-zoom will not function.)

Press ENTER to change between pan and zoom modes (indicated by the + icon in the upper right corner of the screen.)

Press BACK to go back to the Map Tab.

Press MENU to add waypoints, pause/resume the trip, etc.

Press ENTER to change between pan and zoom modes (indicated by the + icon in the upper right corner of the screen.)

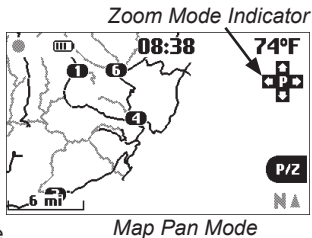

Press BACK to go back to the Map Tab.

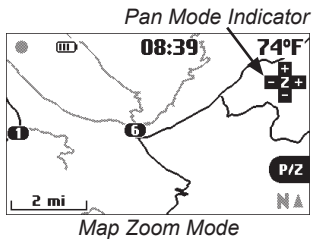

Press MENU to add waypoints, pause/resume the trip, etc.

Zoom/Pan Timeout

By default the Map Pan and Zoom Screens have a timeout function to keep you on the proper Map Screen. By default the timeout is

set for 30 seconds and then reverts you back to the Map Screen. To adjust the length of the timeout:

[Set > Map Settings > P/Z Timeout](#)

Engine Temperature Tab:

Voyager displays a graph of the engine temperature's history for the current trip in the engine temperature tab.

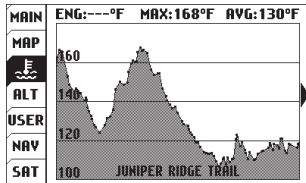

Engine Temperature Tab 1

Engine Temperature Tab Screen 2:

Press RIGHT to enter tab 2. You can scroll along the graph - the time stamp and engine temperature selected by the cursor will be displayed at the top of the screen.

Press BACK to exit.

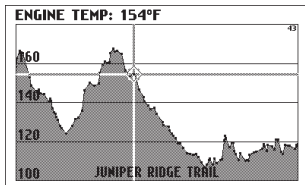

Engine Temperature Tab 2

Altitude Tab:

The Altitude Tab displays a graph similar to engine temperature, but shows height above sea level.

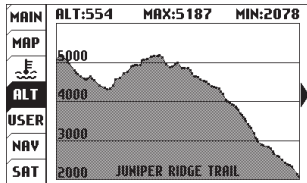

Altitude Tab 1

Altitude Tab Screen 2:

Press RIGHT to enter altitude tab screen 2.

Press BACK to exit.

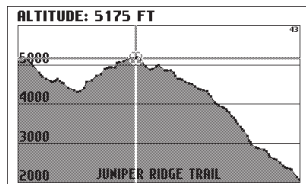

Altitude Tab 2

Note: Logging must be active to save engine temperature and altitude history.

User Tab:

The user screens are customizable. Choose 1-6 items for display. Press RIGHT from the user tab to see the second user screen. Press MENU to edit. For each screen, you can change the screen name, and what and items are displayed.

MAIN	ROBERT'S SCREEN	
MAP	GPS SPD MPH	WHEEL SPD MPH
	0	0
ALT	GPS ODO MI	WHEEL ODO MI
USER	523.7	247.3
NAV	INPUT V	BATTERY V
SAT	0.0	3.7

User Screen 1

Data Blocks:

Display 1-6 data blocks. if you turn off some blocks, Voyager will center the remaining blocks on the screen for better visibility.

User > User Screen Settings:

Edit the screen title and choose items to appear on the screen.

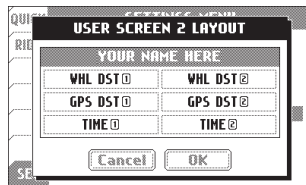

You can have 1-6 blocks displayed.

Choose from the wide variety of statistics Voyager tracks and is able to display.

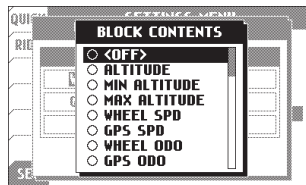

Available Data Blocks for User Screens:

- <OFF>
- Altitude
- Min Altitude
- Max Altitude
- Wheel Speed
- GPS Speed
- Wheel Odometer
- GPS Odometer
- Engine Acc. Run Time
- GPS Acc. Run Time
- Air Temperature
- Engine Temperature
- Max Engine Temperature
- Avg Engine Temperature
- Clock
- Stop Watch
- Heading
- Compass Direction
- Input Voltage
- Internal Battery Voltage
- Tachometer
- Wheel Distance (1)
- GPS Distance (1)
- Engine Trip Time (1)
- GPS Trip Time (1)
- Max Wheel Speed (1)
- Max GPS Speed (1)
- Avg Wheel Speed (1)
- Avg GPS Speed (1)
- Wheel Distance (2)
- GPS Distance (2)
- Engine Trip Time (2)
- GPS Trip Time (2)
- Max Wheel Speed (2)
- Max GPS Speed (2)
- Avg Wheel Speed (2)
- Avg GPS Speed (2)
- Current (Battery Charger)

Navigation Tab:

The navigation tab displays a compass, current speed, trip distance or destination distance (the distance to the currently selected waypoint) and a stop watch.

Destination Waypoints:

If a destination waypoint has been selected, then “destination distance” will be displayed and the compass arrow will point towards the desired waypoint (when it points straight up, you are heading in the correct direction.) Press MENU to select a waypoint destination from the

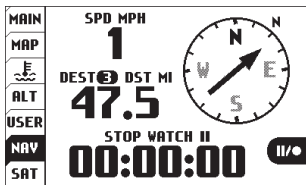

Navigation Tab

Navigation Example:

Set a destination waypoint at base camp before leaving, and the navigation compass always points back in case you get lost..

Stop Watch:

Start or stop the stop watch by pressing ENTER. Press and hold ENTER to reset the stop watch.

Satellite Tab:

The satellite tab displays a graph of the sky and the relative GPS satellite reception. The sky graph shows the position of the satellites in the sky.

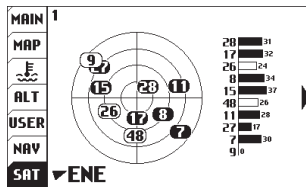

Satellite Tab

The reception bar graph shows the relative signal strength of each satellite.

Latitude / Longitude:

Press RIGHT from the satellite screen to view your current latitude and longitude positions.

Menu

The menu consists of 3 menu tabs: Quick, Ride and Set. The Quick menu has the most frequently used commands, like toggling GPS logging. The ride menu controls features related to your current ride, or saving/loading tracks. The set menu contains the system settings. Enter the menu by pressing the MENU button. Press LEFT on the joystick until the tab is highlighted, then up/down to change tabs.

Quick Menu:

In the quick menu you can toggle logging, reset ride memory and trip distance, import/export rides, add waypoints and select a destination waypoint.

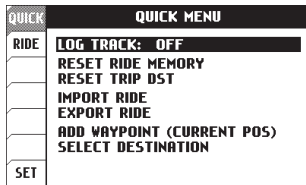

Quick Menu

Log Track:

Toggle logging OFF/ON. Even if set to ON, logging will still pause if Voyager is not moving, or does not have a GPS fix.

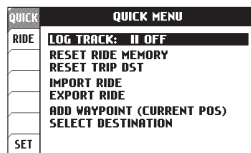

Logging On

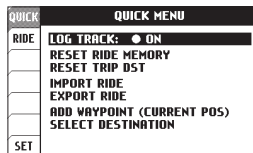

Logging ON

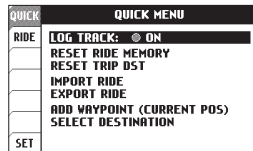

Logging On but not Active

Reset Ride Memory:

This will erase all tracks, routes, and waypoints currently in memory, and will reset the trip distance counters.

Reset Trip Dist:

Reset Trip Distance(1) is visible both on the Main screen and User screen. Voyager has a second counter, Trip Distance(2) visible only on the User screen. Trip Distance(2) can be reset in the ride menu or by performing a ride memory reset.

Import:

Import a GPX file from the MicroSD card. The new route will be added to whatever Voyager currently has in memory. By default, all GPX tracks are imported as routes. Voyager displays routes as grey lines and tracks as black lines. This makes it easier to distinguish between them. Change the import settings in the ride menu to import GPX tracks as tracks.

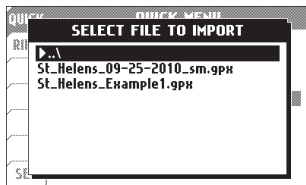
**Export:**

Writes all tracks and waypoints to a file on the MicroSD card. By default, it does not export routes, but that can be changed in the ride menu's Export Options..

Add Waypoint (Current Pos):

Places a waypoint at your current position on the map.

Select Destination:

Choose a previously set waypoint that you would like to navigate to. After selection, the Nav screen will display the selected waypoint, distance to it, and the compass will point towards it.



Select Destination Waypoint

Ride Menu:

The ride menu is where rides are maintained. Start or stop tracks, or import/export to the MicroSD card for use on your personal computer. Routes can be loaded from the MicroSD card for display on the map alongside your current ride.

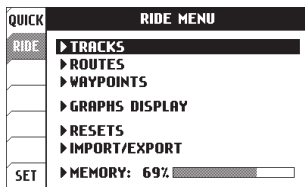

Ride Menu

Difference between Tracks and Routes:

A route appears grey on Voyager. It is intended to show where to ride (i.e. un-ridden trails and roads.)

A track appears black on Voyager. It shows the current ride (i.e. where you have been or are currently riding.)

Tracks:

A track is made by logging movement. Tracks can be started, renamed, erased, or imported/exported. The display of tracks can be individually toggled on/off.



Ride Menu > Tracks

Routes:

Routes can be erased, renamed, or individually toggled on/off.

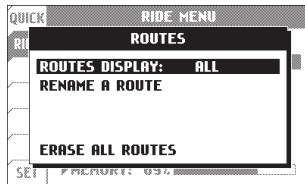

Ride Menu > Routes

Waypoint display can be toggled, renamed, selected or added/erased.

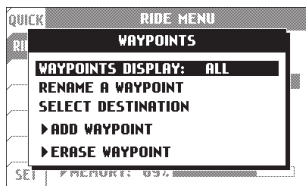

Ride Menu > Waypoints

When adding a waypoint, you have the choice of adding the waypoint at your current position, entering a latitude/longitude, or selecting by crosshair. The crosshair selection opens the map screen to let you place the waypoint visually.

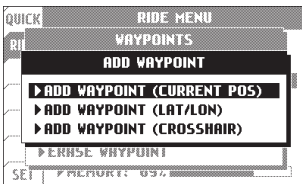

Ride Menu > Waypoints > Add Waypoint

If you select a destination waypoint, Voyager will know that you wish to navigate towards it. On the Navigation tab the distance to the selected waypoint will be shown (DEST DST) and the compass arrow will point towards the desired waypoint. When the compass arrow points straight up, you are heading in the correct direction.



Ride Menu > Waypoints > Select Destination

Resets:

On the reset menu, you can erase the current ride, or reset the Trip DST/stopwatch counters. Resetting ride memory erases all tracks, routes, and waypoints currently in internal memory. Note that Voyager is unable to erase data from the MicroSD card; if you need to free up space, do so on your PC.

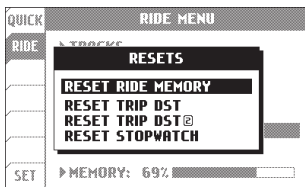
*Ride Menu > Resets***Import/Export:**

Import/Export allows you to save to or load files from the MicroSD card. By default both tracks and routes import as routes (grey lines) so that you can log tracks (black lines) over them. In the import settings you can change this behavior. (i.e. you want roads to import as tracks and trails as routes, to tell the difference.)

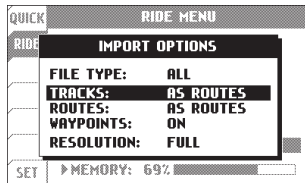
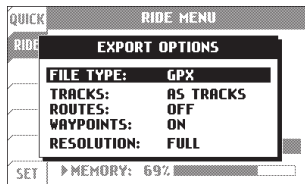
*Ride Menu > Import/Export**Ride Menu > Import/Export > Import Settings**Ride Menu > Import/Export > Export Settings*

Graphs Display:

On the graph screens, you can choose to show either the current track, or a previously logged track or route. If tracks have been imported from the MicroSD card, their graphs may also be loaded for graph viewing. If a GPX file is loaded that does not contain engine temperature and/or altitude data, then the graph will be empty.

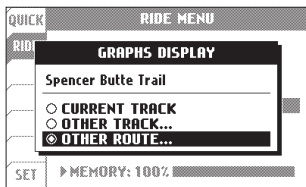

Ride Menu > Graphs Display

Memory:

Voyager has several types of memory limitations to be considered:

1. A maximum of 300 tracks and 72,500 point can be loaded into internal memory at one time. However, there is also a space limit (it is possible for 1 extremely long track to take up

100% of available space.)

2. Routes have a similar memory allocation to tracks you can store 300 routes or 72,500 points. Notice in the screenshot below that although there are more routes than tracks loaded, they are less detailed and take up a lower % of space.

3. A maximum of 300 waypoints can be stored.

4. The MicroSD card can also be filled up, depending what size of card you are using. Voyager is unable to erase data from the MicroSD card; if you need to free up space, do so on your PC.

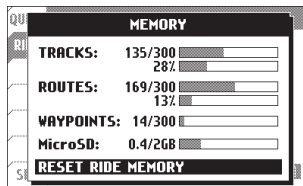

Ride Menu > Memory

Settings Menu:

The settings menu contains the options that control the behavior of Voyager.

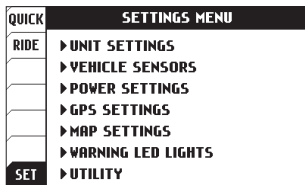

Unit Settings:

The Unit Settings menu allows you to choose between metric or standard systems.

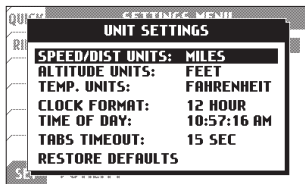

Unit > Speed/Distance Units:

Choose miles or kilometers.

Unit > Altitude Units:

Choose feet or meters.

Unit > Temperature Units:

Choose Fahrenheit or Celsius.

Unit > Clock Format:

Choose between 12H or 24H.

Unit > Time of Day:

Enter the current time in your time zone.

Unit > Tabs Timeout:

Change the length of time when left Tabs collapse.

Vehicle Sensors:

The Vehicle Sensors settings control sensor logging behaviors.

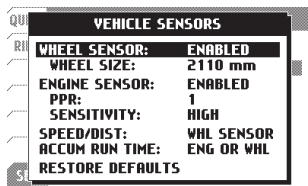

Vehicle Sensors > Wheel Sensor:

Enables or Disables wheel sensor for logging.

Vehicle Sensors > Wheel Size:

This setting is critical for proper operation of the wheel sensor. See the measure wheel size section for more information.

Defaults:

Motorcycle:	2110mm
ATV:	1675mm

Vehicle Sensors > Engine Sensor:

Enables or Disables engine sensor for logging.

Vehicle Sensors > PPR (Pulses Per Revolution):

This is the amount of time the spark plug fires per engine revolution.

Vehicle Sensors > Sensitivity

Sensitivity for Voyager unit reading the pulses from the spark plug.

Vehicle Sensors > Speed/Dist

Speed and distance data pull location.

Vehicle Sensors > Accumulated Run Time:

Voyager defaults to "ENG or WHL" so that Accumulated Run Time (the total time the vehicle has been running) only increments when the wheel is rolling or the engine is turned on. You can change it to increment when GPS thinks it is moving. Over time this will cause inaccuracy due to GPS signal wander. ART will not increment if Voyager falls into sleep mode. By default, this will not happen because wheel and engine activity will keep Voyager awake.

Power Settings:

The power settings let you choose the behavior of the backlight, power-saving and charging.

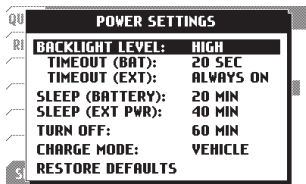
**Power > Backlight Level**

Choose the brightness of the backlight, (off, low, med, high).

Power > Timeout (BAT):

Set the amount of time the backlight stays lit (since the last button press or wheel movement) when running off the internal battery.

Power > Timeout (EXT):

Set the amount of time the backlight stays lit (since the last button press, wheel movement, or engine sensor) when connected to the external vehicle power.

Power > Sleep (Battery):

Set the amount of time to wait (after the last button press, wheel movement, or engine sensor) until Voyager enters sleep mode when on internal battery. During sleep mode, the screen is blank and Voyager conserves power.

Power > Sleep (Ext Pwr):

Set the amount of time to wait (after the last button press) until Voyager enters sleep mode when on external battery. During sleep mode, the screen is blank and Voyager conserves power.

Power > Turn Off:

Voyager shuts down after the allotted time to conserve power.

Power > Charge Mode:

Voyager is able to charge using the 9000-ACA wall adapter or the vehicle's internal regulated AC or DC power. "Wall Plug" mode is meant for use only when Voyager is plugged into the wall using the AC adapter (if used on a vehicle, the vehicle battery may eventually be drained.)

GPS Settings:

The GPS settings control map and logging behaviors.

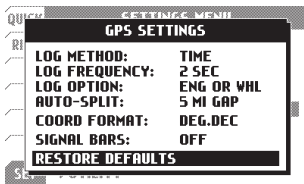

GPS > Log Method:

Log data points after a time interval, or after a distance interval.

GPS > Log Frequency:

Controls the frequency that data points are sampled and added to the current track log. The less time/distance between log intervals creates a more detailed files, while more time/distance creates smaller file sizes (but lower fidelity data.)

Time(1 sec, 2 sec, or 5 sec)

Distance(1ft, 10ft, or 50ft)

GPS > Log Option:

IMPORTANT: This setting can cause Voyager to not log. If set to “engine sensor” or “wheel sensor,” then Voyager will not log unless the sensor sees activity. This is to help create clean log files, only logging when the wheel or engine sensor is activated.

If set to “always,” then Voyager will use GPS movement to determine when to stop logging. Because GPS isn’t aware of your vehicle, it has to wait for you to move a short distance before turning logging on (thus somewhat less precise than using sensors attached to the vehicle.)

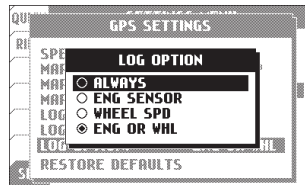

GPS Settings > Log Option

GPS Settings > Auto-Split:

Auto-Split automatically creates a new track if Voyager does not sense a GPS signal for a specific set distance while logging track is on. Default set to 5 miles (Off, 1, 5 and 10 miles)

GPS Settings > Coord Format:

Allows you to choose the Coordiance Display Format. (deg.dec), (deg, min.dec), or (deg, min, sec)

GPS Settings > Signal Bars:

If turned on, satellite signal strength bars will appear on the main tab screen.

**Map Display Settings:**

The map display settings let you change the behavior of multiple map screens.

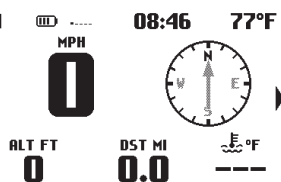
**Map Settings > Orientation:**

Set how the map is displayed. If set to “track up” then the map rotates on the screen in the direction of travel. “North up” leaves the map stationary on the screen and the cursor rotates instead.

Map Settings > Pointer Size:

Select the size of the mouse pointer on the map screen. Choose small, medium, or large.

Map Settings > Map Screen (1 & 2):

“Auto-Center” Automatically pans the map as you move so that your currently location is always in the center of the screen. Auto-center does not function in pan/zoom mode (see page 22.) “Fixed” fixes the map to one position on the map.

Map Settings > Options > Track/Route Labels:

Turn on or off track and route labels.

Options > Track/Route Labels(Clipping):

Clipping distance allows the track/route labels to automatically turn off when zoomed out at a certain point. This keeps the screen from becoming cluttered with labels

Map Settings > P/Z Timeout:

The Map Pan and Zoom Screens have a timeout function to keep you on the proper Map Screen. By default the timeout is set after 30 seconds it will revert you back to the Map Screen.

Map Settings > Options > Waypoint Icons:

Select style of waypoint icons, basic “Dots” or numbered “ID#’s”.

Map Settings > Options > Waypoint Labels:

Choose size of waypoint labels.
(off, small, or large)

Warning LED Lights:

The warning LED’s will turn on or flash when the temperature reaches set points.

The warning LEDs are disabled by default. Here are some suggested values:

Yellow LED on:	90°C (190°F)
Red LED on:	100°C (210°F)
Yellow LED flash:	110°C (230°F)
Red LED flash:	120°C (250°F)

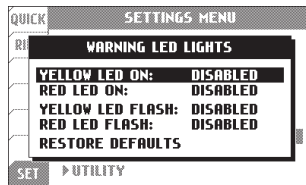

Utility Menu:

This menu contains items not needed for normal use.

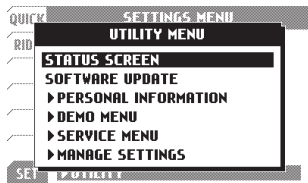

Utility > Status Screen:

Provides an overview of system variables.

Utility > Software Update:

Upgrades Voyager software. Visit www.trailtech.net for the latest releases. After downloading from Trail Tech, copy the file to the MicroSD card, then select it with this function.

Utility > Personal Information:

You are encouraged to input your name, address and phone number for identification purposes.

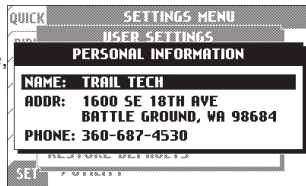

Utility > Demo Menu:

Allows you to play back a recorded track in realtime. For demo purposes.

Utility > Service Menu:

Password protected features. Only available to Trail Tech technicians.

Utility > Manage Settings:

Allows you to save and load your settings to your SD card.

RideLeader GPS File Editor

RideLeader can be found on the CD included in your Voyager kit, or online at http://trailtech.net/ride_leader.html. Visit often for upgrades.

RideLeader allows you to compile trail systems (either from personal riding or online downloads.) You can also draw your own tracks overlaid on Google Earth or a street map.

This is a good way to organize, edit, and prepare information for use on Voyager.

After you have prepared your tracks, you will copy them to a MicroSD card, then import them to Voyager. Because Voyager has memory limits, the GPX editor is also useful to reduce the size of tracks and merge tracks before importing.

Opening the GPX Editor:

Download or find the RideLeader folder on your CD. Double-click the setup file to install it to your computer. RideLeader will open automatically after the quick installation.

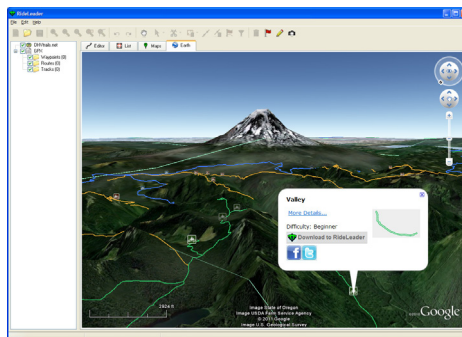

RideLeader opens with no tracks loaded. The first thing to do is load your tracks (or get them directly from OHVtrails.)

Importing:

The quickest way to get tracks is to use the embedded OHVtrails.net feature. Make sure it is checked on in the left trails panel, then go to the Google Earth tab. If there are trails in your area, you will see them with small trail icons. Click the icon to move the trail into the local collection.

Importing:

The GPX Editor does best with GPX files, but will also import NMEA, NGT, OSM and KML files. Open files from the File menu, or drag-and-drop.

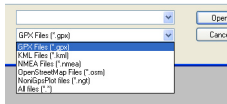

On the included CD, there is a folder with example files. Open the sample GPX file. A trail system will appear, with motorcycle trails colored orange and roads colored blue. The

trails are orange because they are routes. They will be imported into Voyager as grey lines, ready to be ridden and overlaid with a bold track. The roads are tracks, and will be imported in Voyager as bold lines, so you can tell the difference between a road and a trail.

By default, Voyager imports both tracks and routes as greyed routes. You can change this behavior so that tracks import as tracks in the Voyager menu.

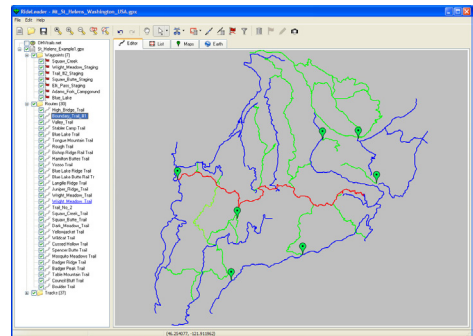

Imported Sample File

Navigation:

A few simple tools control the view. The pointer tool pans, and the hand tool selects tracks and routes. The eyeglass tools or roller button on your mouse controls zoom level.

Hand Tool, Pans Pointer Tool, Select Tracks

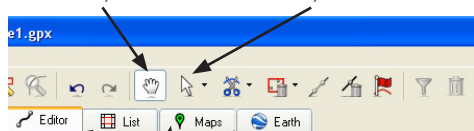

Tabs switch between line-art preview and Google Maps/Satellite/Earth view.



Google Maps Tab - Earth view. Hold down the center mouse button to modify perspective.

Editing:

The editing tools allow you to add, erase, split, merge and simplify tracks

Cut/Split Track Add Waypoint On Selected Delete Selected

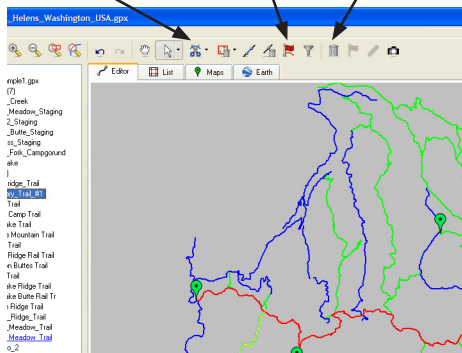

Draw New Track:

On the Google-Maps tab, you can draw your own trails and set waypoints anywhere on the map. When drawing a route, click once on the map for each data point (many data points make up a track segment.)

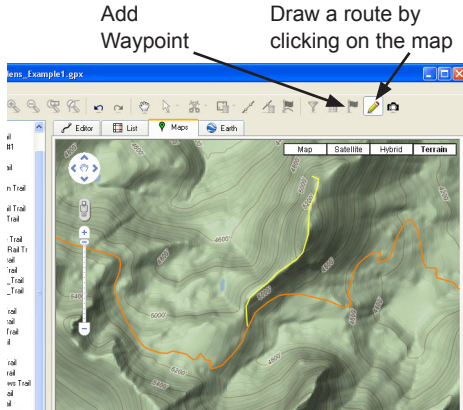
**Reduce Number of Data Points:**

Tracks created by some sources will have far too many data points. To reduce file size, remove some of the data points (so it loads faster in Voyager.) Select the track with the select tool, then press the Filter button in the toolbar.

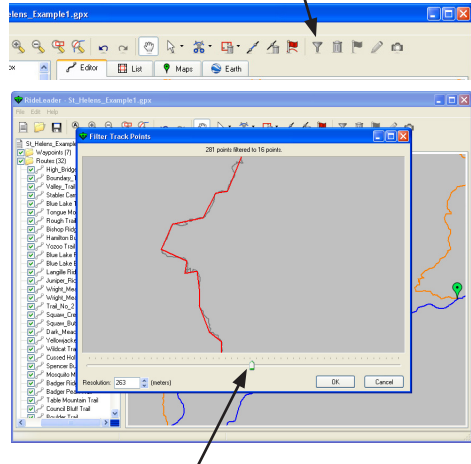
Filter/Simplify

Simplify until you see detail being reduced.

OpenStreetMaps.org

Load street maps into Voyager:

www.openstreetmaps.org

First, find the roads you want to upload into Voyager. You should only select the small area around the planned ride, to reduce the file sizes.

1. Go to Openstreetmaps.org.
2. Go to the Export tab.
3. Click on “Manually select a different area.”
4. Click and drag a box on the map that contains the roads you want to upload to Voyager.
5. Click the Export button.

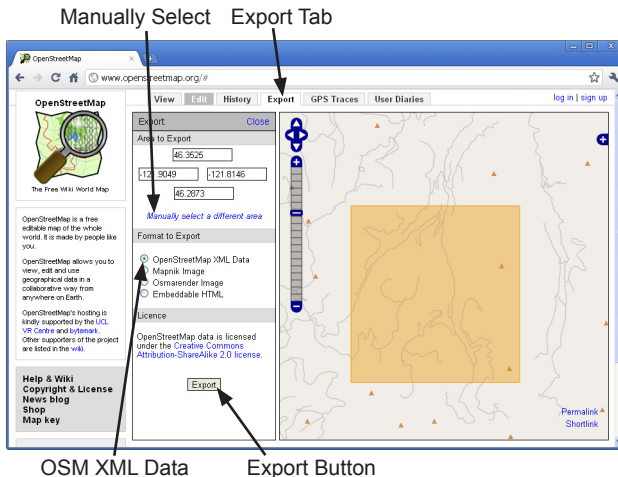

The file will export in .OSM format which needs to be converted to .GPX for Voyager. Open the file in RideLeader, then save as .GPX. Consider deleting excess waypoints and filtering down track data

GPS Babel

Convert other GPS files to GPX:

If you need to convert a rare GPS file format to GPX, GPSBabel may be able to help.

“GPSBabel converts waypoints, tracks, and routes between popular GPS receivers and mapping programs.”

~ www.GPSbabel.org



Download and Install GPSBabel

Trail Tech Voyager

Run GPSBabel to convert the file to GPX.

Select the type of file you are trying to convert as the input format and “GPX XML” as the export format. Use the File Name button to select the file, then click apply.

Before uploading the exported file to Voyager, open it in the RideLeader to delete excess waypoints and filter down the track data points.

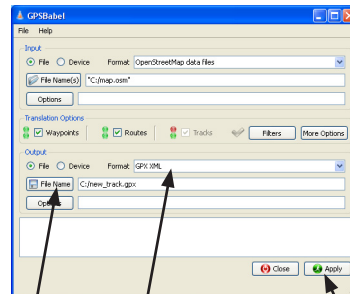

File Name

GPX XML

Apply

Google Earth

Google Earth is an excellent resource to view GPS tracks.

<http://earth.google.com>.

Use your mouse to spin the planet, or shift+mouse to change the 3D view angle.

You can view tracks exported from Voyager, or downloaded from OHVtrails.net or Openstreetmaps.com.

You can also draw tracks that can be imported into Voyager.

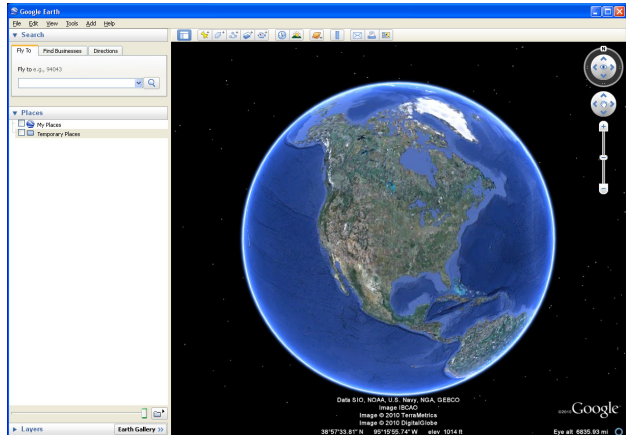

Google Earth at start

Tip: In Tools>Options...>3D View, increase the Elevation Exaggeration to make mountainous terrain more visually impressive.

Draw and Export a Track to Voyager

To draw a track, click on the “Add Path” button in the toolbar. A dialog box appears (ignore it for now.) Using your mouse cursor, click along the path right on top of the Earth. After you have drawn the complete line, click OK in the dialog box to save the changes.



On the side of the screen in the Places sidebar, right-click your new track and select “Save Place As...” Google Earth will save it as a KML file. You will need to convert the file to GPX using GPSBabel, then it is ready to copy to the MicroSD card for import into Voyager.

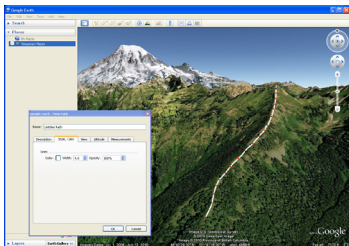

Import a Track from Voyager

Google Earth can import GPX files directly from Voyager. Select Export on Voyager to save the file to the MicroSD card, then on your PC, drag-and-drop the GPX file onto Google Earth.

During import, check all three boxes yes, including Create KML LineStrings. It is likely that once the track is loaded, there will be a lot of named points visible that obscure the track line. To remove them, in the sidebar expand “GPS device,” then right-click on Tracks and select Properties. Go to the “Style, Color” tab and click the “Share Style” button. Modify Label and Icon scale to 0. Do the same for Routes.

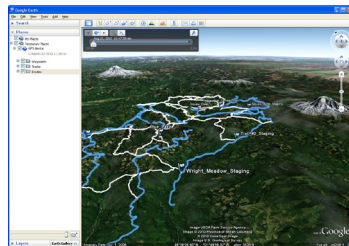

OHVtrails.net

Download your adventure at
www.OHVtrails.net.

Download trails and load them
directly into Voyager. Entire trail
systems are at your fingertips.

Hiking trails not allowed; all included
trails are either motorcycle, ATV, or
snowmobile.

Hold down shift and click to tilt the
camera into 3D Google Earth mode.

You can also upload trails for overlay
viewing online among the stock
trails.



www.OHVtrails.net - Choose a Trail to Download

You can grab trails directly from within RideLeader by checking the OHVtrails.net checkbox. Go to the Google Maps tab. Click on the trail marker icons to move the trail into RideLeader's local collection.

Glossary

Ride

A “ride” is the collection of information Voyager is currently logging and displaying (including the map, altitude, engine temperature, trip distance, etc.) The ride can be cleared by performing a “reset ride memory.”

Track

Tracks appear on the map as dark black lines. They are trails that have been logged on the current ride. They can be imported/exported to the MicroSD card.

Route

Routes appear on the map as grey lines. They are intended to be imported from internet data or previous rides and followed along. While following, Voyager logs a new track that appears black on top of the grey route line.

Trip Distance

Trip distance is a measure of how far you have travelled. While it is part of the current ride memory, it can be reset independently. Trip distance 1 is displayed on the main screen, while a second trip distance can be selected to appear on the user screen.

Destination Distance

The distance between your current position and the currently selected waypoint. You can select a new destination waypoint in *Ride Menu>Waypoints>Select Destination*.

Trail Tech, Inc.

Thank you for using Voyager Moto-GPS. If you have further questions, do not hesitate to call Trail Tech at 360-687-4530, or email tech_support@trailtech.net.

MADE IN



U. S. A.

CONFORMITÉ



EUROPÉENNE



RECYCLE

MicroSD
MEMORY CARD

Manual Version 2.0

LIMITED WARRANTY

Within one year from the date of original purchase, Trail Tech will repair or replace, at its option, any Trail Tech powersport computer which is deemed defective in workmanship or materials. Please contact Trail Tech or the dealer where the item was purchased for assistance.

Damage or injuries resulting from negligence or misuse are not covered by this warranty. Incidental or consequential damages are specifically excluded.* This warranty gives you specific legal rights. You may also have other rights which vary from state to state. **Because some states do not allow the exclusion of incidental or consequential damages, this exclusion may not apply to you.*

MADE IN AMERICA

TRAIL TECH

Trail Tech and Voyager are trademarks of Trail Tech, Inc.

www.trailtech.net

360-687-4530