

2.4GHz Digital Wireless Video Door Phone User Manual



- Thank you for purchasing our product.
- Please read carefully this user manual before using the product and follow manual exactly install and operate.

Contents

1. Introduction.....	2
2. Features	2
3. Packing list.....	3
4. Outdoor camera.....	3
5. Indoor Monitor.....	4
6. Installation instructions of outdoor camera.....	5
7 E-lock installation.....	6
8. Operation.....	7-10
9. Working Environment	10
10. Notices.....	10
11. Failure diagnosis	11

1. Introduction

The product is widely used in apartment, hotel, villas, office, building and so on. The system is composed of outdoor camera, indoor monitor such two parts.

The outdoor camera is easy to install, you can use the indoor monitor where the wireless signal can reach. Indoor monitor can hang on the wall, cabinet; can also be place on the desk, tea table, dining table.

2. Features

- (1) 2.4GHz digital frequency hopping and encryption technology, transmission distance up to 300 meters at open area, robust anti-interference;
- (2) Clear night vision can capture image in low-illumination environment;
- (3) Rain shield for the outdoor camera is available;
- (4) 7 inch Digital TFT color panel;
- (5) High-strength tempering glass, abrasion resistant, scratch, longer working life;
- (6) High Sensitivity touch keys
- (7) Monitor, wireless unlock, hands-free call and talk;
- (8) 16 chord melodies and melody volume is adjustable;
- (9) Date and time show on screen;
- (10) Indoor monitor store up to 100pcs pictures, pictures mark date and time;
- (11) Brightness and talk volume are adjustable
- (12) BL-5J battery of camera and monitor is replaceable and rechargeable;
- (13) Outdoor camera has two work modes:
 - 1) Indoor monitor can monitor anytime if plug power adaptor;
 - 2) it works about two moths with battery if not connected power adapter, indoor monitor can not monitor anytime;
- (14) With Wireless unlock control function;
- (15) One outdoor camera supports up to 3pcs indoor monitors and vice versa;
- (16) The outdoor unit with the function of tamper alarm

3. Packing list

- (1) Outdoor camera, size: 132×90×42mm
- (2) 7" indoor monitor, size: 225×135×18mm
- (3) Power adapter for outdoor camera ; Input: 100-240V 50/60Hz Output: 5V/1A
- (4) USB power adapter for indoor monitor; Input: 100-240V 50/60Hz Output: 5V/1A
- (5) BL-5J battery of camera (optional) and monitor
- (6) Screws and stoppers
- (7) User manual
- (8) Color box

4. Outdoor camera

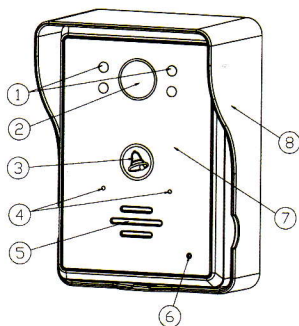

- (1) Infrared light
- (2) Camera lens
- (3) Indicating light
- (4) Speaker
- (5) Armoured glass
- (6) Rain shield
- (7) 'Pair' button
- (8) Tamper alarm

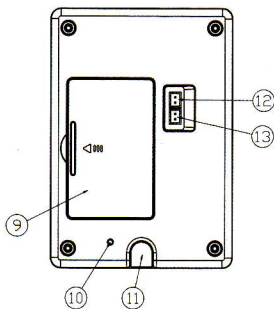

- (9) 'Call' button
- (10) Microphone
- (11) Battery lid
- (12) Connect the electric lock
- (13) Power

5. Indoor Monitor

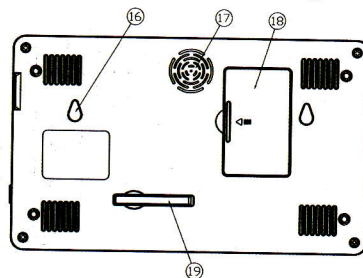
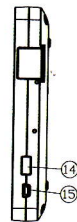
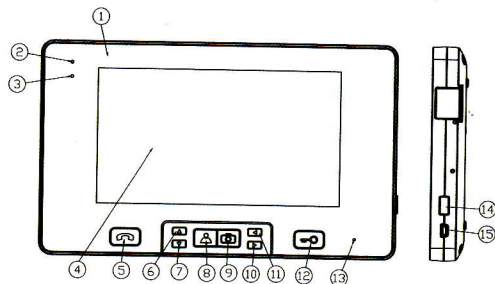

- (1) Armoured glass
- (2) Power light
- (3) Working light
- (4) TFT screen
- (5) 'Talk' button
- (6) ▲ Up
- (7) ▼ Down
- (8) 'Monitor' button
- (9) 'Take picture' button
- (10) ► Right
- (11) ◀ Left charging light
- (12) 'Unlock' button
- (13) Microphone
- (14) Power switch
- (15) USB interface
- (16) Fixed slot
- (17) Speaker
- (18) Battery lid
- (19) Bracket

6. Installation instructions of outdoor camera

The outdoor camera should be installed at the shielded position to be free from direct shining of strong light and raining, the height for installation is recommended to be 1.5m~1.7m for outdoor camera to focus on the best monitoring range. Com-signal will be weakened if there are obstacles between the installation position of outdoor camera and indoor monitor, check the best sign of monitor when install the outdoor camera to get the best position.

If wiring needs to go through wall, the plug shall be first wrapped with tape so as to avoid the sand or dirt going into the plug thus resulting in malfunction.

Use double-sided tape fix outdoor camera on the wall or door.

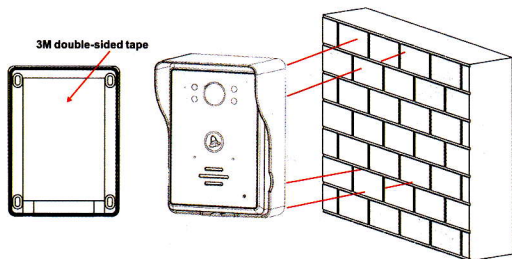

Or Take off the screw on the bottom, remove the back box fit to the wall, embed the outdoor camera to back box and use screw to fix

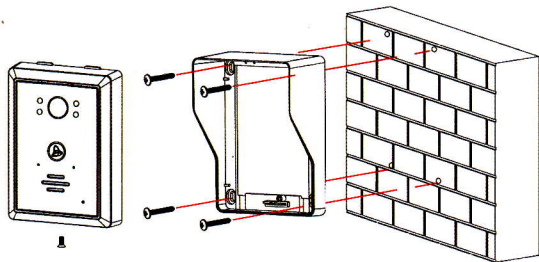

5

7 E-lock installation

This system doesn't provide e-lock and power of e-lock, user can purchase them based on requirement. Wireless unlock control which is set up on the e-lock, shares with e-lock when it works.

Notes: You should guarantee that the distance between wireless unlock control and outdoor camera should be within 10m so that wireless unlock control can receive unlock command.

Power supply control

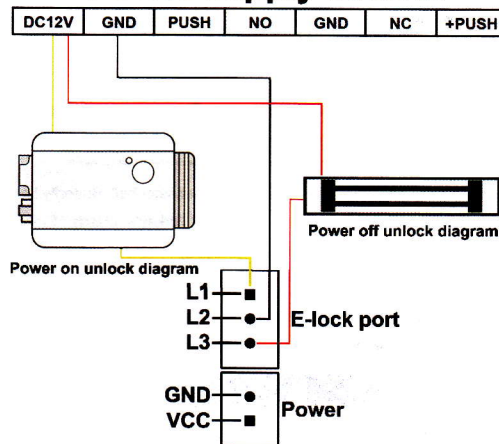





6

8. Operation



Note: the system in working condition, if there is no blocking wall between indoor monitor and outdoor camera, must keep above 6 meters between two units to avoid produce 'whistle' sound.

A Setting

(1) Date and time

When indoor monitor is in open mode, press  button for 2 seconds, users can set the date (month/day/year) and the current time (hour/min): time format for 24 hours, press ,  button to select, press ,  button to adjust the time and date in grey.

(2) Melody and volume

When indoor monitor is in open mode press  button to select one of the 16 chord melodies for the bell and sound the melody selected simultaneously, press  choose to the volume of melody, adjust level: 1-2



16 chord melodies are Ding-dong, To Alice, Westminster bell, Butterfly lovers, The cygnet, Red river valley, My heart will go on, Turkey's march, Small dance, Congratulations you, William's prelude, Love romance hudson, Memory, The Little Mermaid, Green sleeves, Romeo and Juliet.

(3) Talk volume

In the talk mode, press ,  adjust the talk volume, adjust level: 0-7



(4) Brightness

Indoor monitor has dynamic image from outdoor camera, press ,  adjust brightness, adjust level: 0-7



B Operation

(1) Indoor monitor turn on/off

Turn on: Turn the power switch for 2 seconds, working light display red and rings the melody.

Turn off: Turn the power switch to for 2 seconds, working light off.

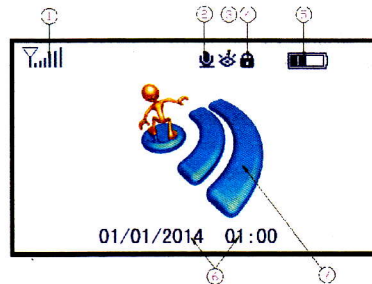

(1)Wireless signal

(2)Talk

(3)Continuous monitoring

(4)Unlock



(5)battery level



(6)Date and time

(7)Boot screen

(2) Talk, unlock

The visitor presses the "call" button of the outdoor camera, all indoor monitors will sound melody and show the image of visitor.

- A. Press  button of one indoor monitor to speak to visitor before unlock. Other indoor monitors can see the image but can not hear sound of the visitor. If you want to let other indoor monitor to talk, press  button to close the current dialogue, then another indoor monitor press  button to speak to visitor.

When in talk mode, press  button to release the door lock, the unlock signal shows on the screen, when release  button, the unlock signal will disappear.



Press  button to turn off the screen and enter standby mode, or it will turn into standby mode automatically after 30 seconds.



B. If do not want to receive the visitor after seeing the video, no operation or press the  button to turn off the screen and then enter into standby mode.

Indoor monitor enter into the standby mode after 30 seconds if no any operation.

Note: if you use multiple indoor monitors, please keep distance between indoor monitors to avoid affecting talk effect.

(3) Monitor

For one outdoor camera or more outdoor cameras with one indoor monitor, if there is no calling from the outdoor camera, and the indoor monitors in standby mode. User can press the  button once to wake up the indoor monitor; press  button again to enter monitor mode and monitor the outdoor as long as you like, monitor signal will display on the screen. Press  button again to quit and close the screen.

For several outdoor cameras with one indoor monitor, in monitor mode, press  button show the image from the CAM1, CAM2, CAM3, CAM4 (if the system has) in sequence; At the last outdoor camera, press  button again to quit and close the screen.

(4) Charge

The first to be charged more than 5 hours to activate the lithium battery, after that charge 3 hours every time, up to 80 hours of standby time..

C Picture





(1) Take pictures

When has video from outdoor camera, presses  button to take a picture, one press for one picture:







If the user isn't in or no any operation, all indoor monitors save the image from outdoor automatically after 10 seconds.

It will replace first picture if exceed available memory when take a new picture.

(2) Browse pictures

Press  button,Then press ,  button to browse the stored pictures. Press  button to exit.

(3) Delete pictures

First turn on the indoor monitor, press  button for 2 seconds, then turn on the  button for 1 seconds,press ,  button to check photos,press  button choose photos,press ,  button to choose yes or no to delete the all pictures.

Delete All?

Y N

D Pair

One outdoor camera and one indoor monitor system

Press 'pair' button of outdoor camera('pair' button in the back of the outdoor), indicating light flash, press  button of indoor monitor at the same time, if pair succeeds, the video from outdoor camera will be shown in the screen of indoor monitor.

9. Working Environment

(1) Working temperature: -15℃—+55℃ (2) Working humidity: ≤85%

10. Notices

- (1) Please don't cover anything on the Microphone or speaker when there is conversation.
- (2) Please always use the specified electric source power supplier adaptor, or that with the same type (same standard voltage and electric current). Using the adaptor unspecified may lead to the damage of the circuit and component of the product.
- (3) Do not attempt to service this product yourself as opening or removing covers may expose you to dangerous voltage or other hazards. Refer all servicing to qualified service personnel.
- (4) Please strictly follow the user manual before you install and test this product. If there is any question, please contact our tech support and customer service;

11. Failure diagnosis

Malfunction	Checking	Debug
Fail to start the product	If turn on the indoor monitor	Turn on the indoor monitor
	If the power of Li-on battery is not enough?	Charge the Li-on battery
Fail to charge	If the plug of power adaptor correctly plug into mini USB?	Re-connect indoor monitor with power adaptor
	If the power adaptor correctly get through the 100-240V AC electricity?	Re-insert the plug to make power adaptor get AC electricity.
Talk mode no voice	If the talk volume is adjusted to be the least?	To adjust the talk volume to be suitable.
The image is flashing or noise	If the indoor monitor is close to induction cooker and microwave oven which has magnetic wave?	Keep indoor monitor far away from these things which has magnetic wave.
Indoor monitor no signal	If the outdoor camera doesn't connect the power?	To connect power adaptor to the outdoor camera
	If the outdoor camera is far away from the indoor monitor?	Keep the distance in 60 meters within (stopped by multi-wall)
	If there is other strong magnetic space bother?	Keep indoor monitor far away from the strong magnetic space