

IC-3140W

Quick Installation Guide

07-2014 / v1.0

Edimax Technology Co., Ltd.

No.3, Wu-Chuan 3rd Road, Wu-Gu, New Taipei City 24891, Taiwan

Email: support@edimax.com.tw

Edimax Technology Europe B.V.

Fijenhof 2, 5652 AE Eindhoven, The Netherlands

Email: support@edimax.nl

Edimax Computer Company

3350 Scott Blvd., Bldg.15 Santa Clara, CA 95054, USA

Live Tech Support: 1(800) 652-6776

Email: support@edimax.com



Copyright © Edimax Technology Co., Ltd. all rights reserved. No part of this publication may be reproduced, transmitted, transcribed, stored in a retrieval system, or translated into any language or computer language, in any form or by any means, electronic, mechanical, magnetic, optical, chemical, manual or otherwise, without the prior written permission from Edimax Technology Co., Ltd.

Edimax Technology Co., Ltd. makes no representations or warranties, either expressed or implied, with respect to the contents hereof and specifically disclaims any warranties, merchantability, or fitness for any particular purpose. Any software described in this manual is sold or licensed as is. Should the programs prove defective following their purchase, the buyer (and not this company, its distributor, or its dealer) assumes the entire cost of all necessary servicing, repair, and any incidental or consequential damages resulting from any defect in the software. Edimax Technology Co., Ltd. reserves the right to revise this publication and to make changes from time to time in the contents hereof without the obligation to notify any person of such revision or changes.

The product you have purchased and the setup screen may appear slightly different from those shown in this QIG. For more information about this product, please refer to the user manual on the CD-ROM. The software and specifications are subject to change without notice. Please visit our website www.edimax.com for updates. All brand and product names mentioned in this manual are trademarks and/or registered trademarks of their respective holders.

Edimax Technology Co., Ltd.

Add: No. 3, Wu-Chuan 3rd Rd., Wu-Ku Industrial Park, New Taipei City, Taiwan

Tel: +886-2-77396888

Email: sales@edimax.com.tw

Notice According to GNU General Public License Version 2

Certain Edimax products include software code developed by third parties, software code is subject to the GNU General Public License ("GPL") or GNU Lesser General Public License ("LGPL"). Please see the [GNU](http://www.gnu.org) (www.gnu.org) and [LPGL](http://www.gnu.org)(www.gnu.org) Websites to view the terms of each license.

The GPL Code and LGPL Code used in Edimax products are distributed without any warranty and are subject to the copyrights of their authors. For details, see the GPL Code and LGPL Code licenses. You can download the firmware-files at <http://www.edimax.com> under "Download" page.

I.	Informations sur le produit.....	4
I-1.	Contenu de l'emballage	4
I-2.	Panneau avant	4
I-3.	Panneau arrière	5
I-4.	État du voyant.....	5
I-4.	Étiquette du produit	6
I-5.	Réinitialiser	6
II.	Installation Matérielle	8
II-1.	Kit de montage.....	8
II-2.	Caméra	9
III.	Configuration de la caméra.....	10
III-1.	Application EdiView	10
III-1-1.	Android	10
III-1-2.	iPhone	14
III-2.	WPS (configuration Wi-Fi protégée).....	18
III-3.	Myedimax.com	19

I. Informations sur le produit

I-1. Contenu de l'emballage



IC-3116W



GIR



CD-ROM



Adaptateur secteur



Câble Ethernet

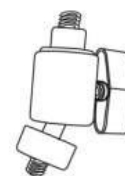
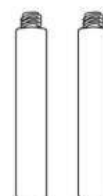
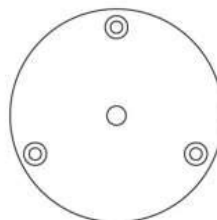

Kit de montage

I-2. Panneau avant

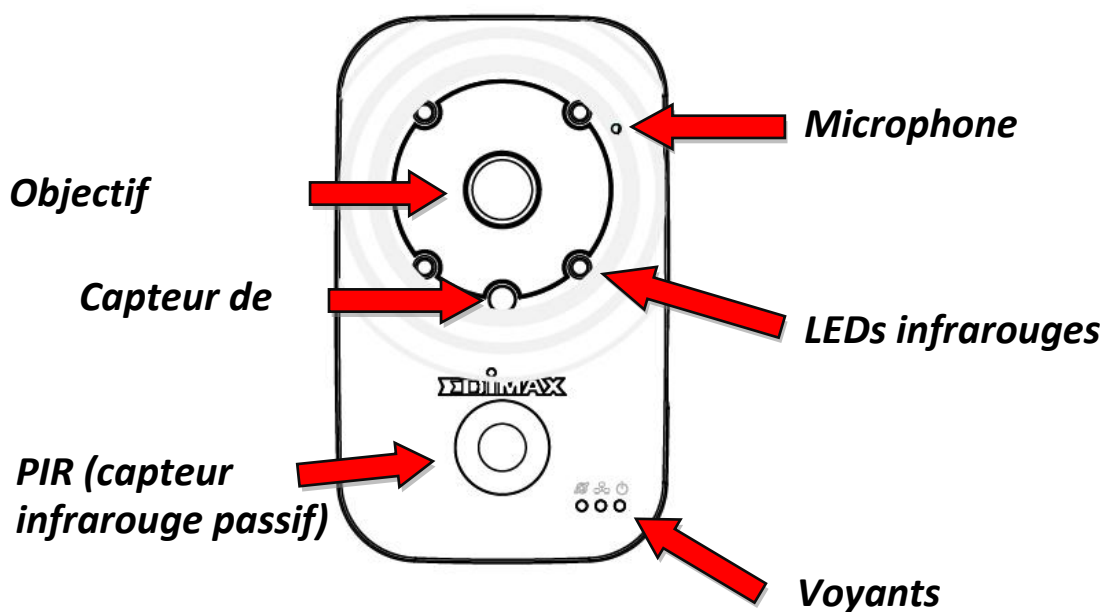

I-3. Panneau arrière

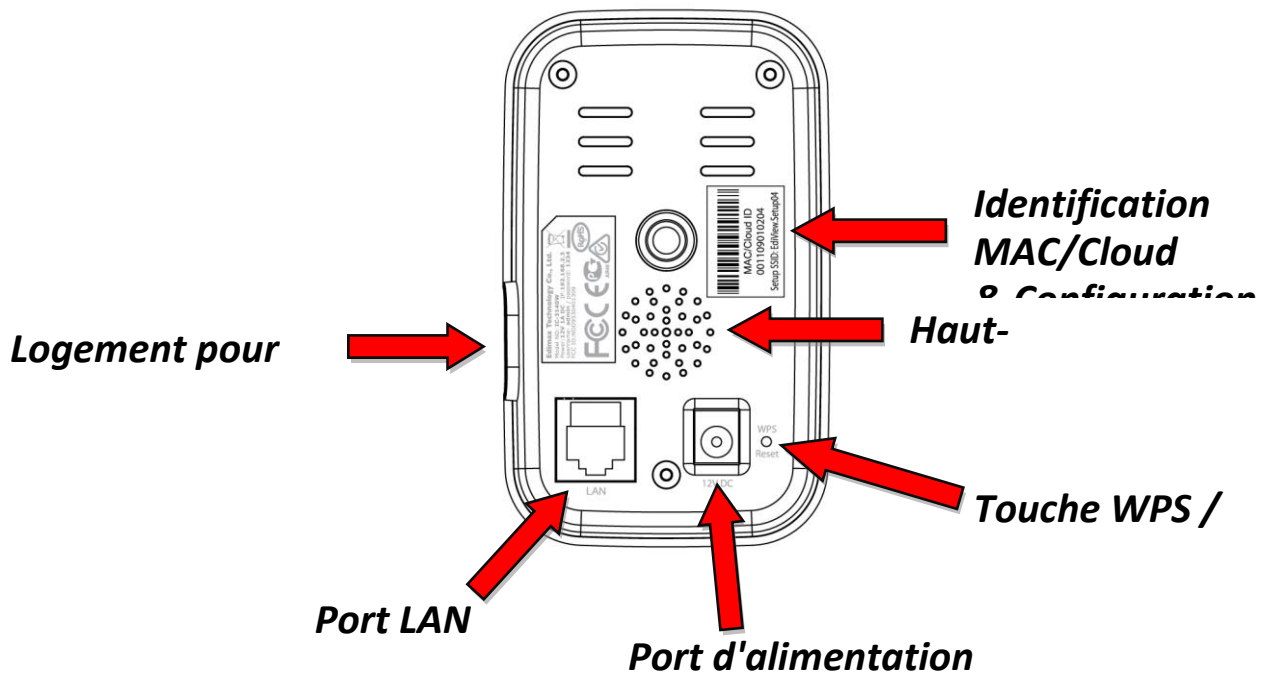

I-4. État du voyant

Voyant	Couleur du voyant	État du voyant	Descriptif
Alimentation	Vert	Allumé	La caméra réseau est allumée et connectée au serveur Cloud.
		Clignote rapidement	La caméra réseau redémarre.
		Clignote lentement (1 fois par seconde)	La caméra réseau démarre OU la caméra réseau n'est pas connectée au serveur Cloud.
LAN	Vert	Allumé	La caméra réseau est connectée au réseau local.
		Clignote rapidement	Activité LAN (transfert de données).
		Clignote lentement (1 fois par seconde)	Le WPS est activé.
Internet	Orange	Allumé	Connecté à Internet.

		Clignote lentement (1 fois par seconde)	Non connecté à Internet.
--	--	---	--------------------------

I-4. Étiquette du produit

L'étiquette du produit située à l'arrière de la caméra indique l'adresse MAC, l'ID Cloud et la configuration SSID de votre caméra réseau.

 **L'adresse MAC et l'ID du Cloud sont identiques pour une question de commodité.**

L'ID du Cloud vous permet d'afficher à distance la diffusion en direct provenant de votre caméra réseau (depuis n'importe quelle connexion Internet) comme décrit plus loin dans la section **III-4. Myedimax.com**.

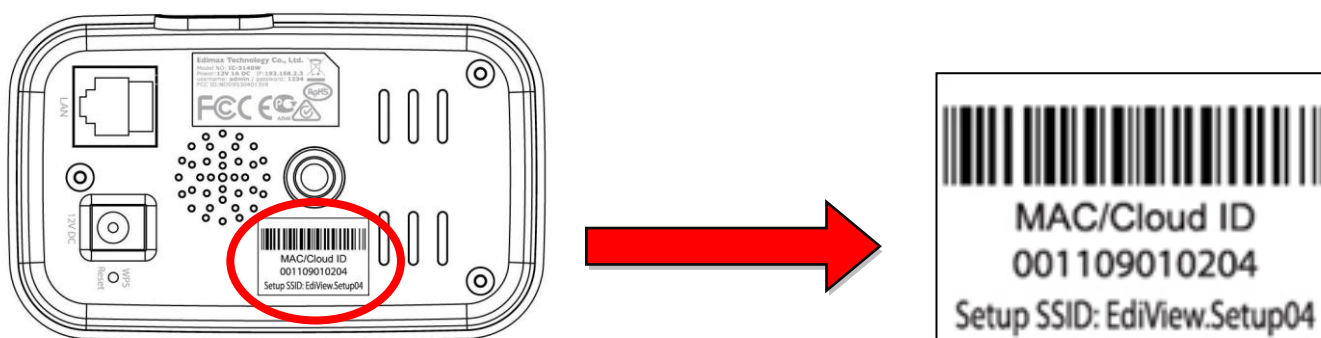

I-5. Réinitialiser

Si vous rencontrez des problèmes avec votre caméra réseau, vous pouvez réinitialiser ses paramètres d'usine par défaut. Cette opération réinitialise **tous** les paramètres aux valeurs par défaut.

- 1.** Maintenez enfoncée la touche WPS/Réinitialisation sur le panneau arrière pendant au moins 10 secondes
- 2.** Relâchez la touche lorsque le voyant d'alimentation **vert clignote rapidement**.
- 3.** Attendez que la caméra réseau redémarre. La caméra est prête lorsque le voyant d'alimentation **vert clignote lentement**.

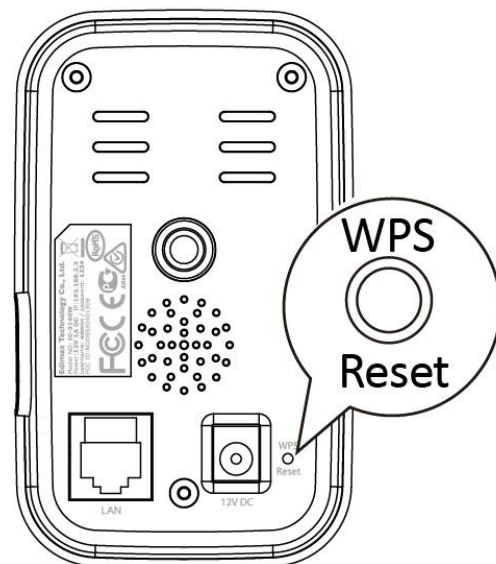



Après l'installation, le voyant d'alimentation **vert** s'allume pour indiquer que la connexion au serveur Cloud a réussi.

II. Installation Matérielle

II-1. Kit de montage

Un pied est fourni avec votre caméra réseau. Le pied doit être assemblé.

1. Assemblez le pied de la caméra comme indiqué ci-dessous. Le pied de la caméra peut être utilisé tel quel ou fixé au mur :

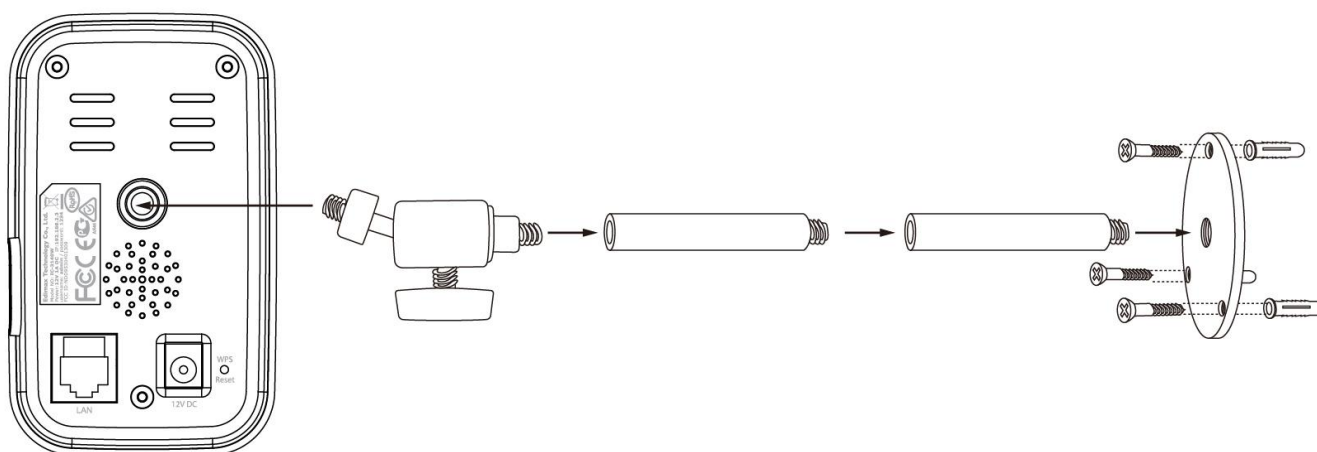

2. Fixez la caméra réseau sur le pied fourni grâce à l'orifice de fixation qui se trouve à l'arrière de la caméra.



Vous pouvez également monter la caméra réseau sur un trépied en utilisant également cet orifice de fixation.

II-2. Caméra

Respectez les instructions ci-dessous afin de garantir que votre caméra est correctement connectée et prête à être configurée.

- 1.** Raccordez l'adaptateur secteur au port d'alimentation de la caméra réseau et à une source d'alimentation, comme illustré ci-dessous.
- 2.** Patientez un instant pendant l'allumage de la caméra. La caméra émet un son et le voyant d'alimentation **vert clignote lentement** quand elle est prête. Merci de vous référer à la section **III. Configuration de la caméra** pour configurer votre caméra réseau à l'aide de l'application gratuite pour smartphone EdiView.

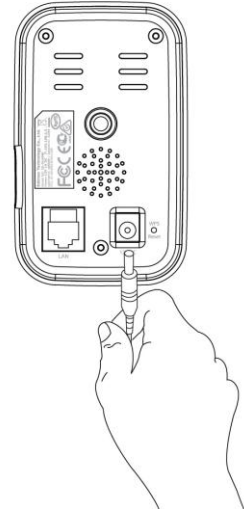

Pour configurer la caméra à l'aide d'un câble Ethernet au lieu d'une connexion Wi-Fi, merci de vous consulter le manuel d'utilisation.

III. Configuration de la caméra

Votre caméra réseau peut être prête à fonctionner en quelques minutes seulement. Suivez les instructions du chapitre suivant pour installer votre caméra à l'aide de l'application EdiView gratuite sur Android ou iPhone.

Vous pourrez ensuite également utiliser l'interface de gestion Internet pour visionner la diffusion en direct et poursuivre la configuration de la caméra si nécessaire (Consultez le manuel d'utilisation pour obtenir de l'aide).

Et vous pourrez également visionner l'image en direct de la caméra depuis n'importe quelle connexion Internet ou n'importe quel navigateur en utilisant l'ID du Cloud (consultez la section III-3.).

Vous pouvez également consulter la section III-2. **WPS** est une méthode alternative pour connecter votre caméra réseau à votre réseau sans fil.

III-1. Application EdiView

Utilisez l'application gratuite pour smartphone EdiView pour configurer la Wi-Fi de votre caméra et surveiller cette dernière à distance depuis n'importe quelle connexion Internet.

 ***Pour configurer la caméra à l'aide d'un câble Ethernet au lieu d'une connexion Wi-Fi, merci de consulter le manuel d'utilisation.***

III-1-1. Android

1. Recherchez "EdiView II" dans Google Play puis téléchargez et installez l'application EdiView II.



2. Assurez-vous que la Wi-Fi de votre appareil Android est activée et ouvrez l'application EdiView II. Sélectionnez votre caméra réseau comme indiqué ci-dessous, puis cliquez sur "OK" pour continuer. Patientez un moment, le temps que EdiView se connecte à votre caméra réseau.



Sélectionnez le SSID de votre caméra réseau. Le SSID unique est indiqué sur l'étiquette du produit à l'arrière de la caméra. Il est composé de "EdiView.Setup", ** étant les deux derniers caractères de l'adresse MAC unique de votre caméra.**



- 3.** Sélectionnez votre réseau Wi-Fi dans la liste puis saisissez votre mot de passe Wi-Fi avant de cliquer sur "OK".

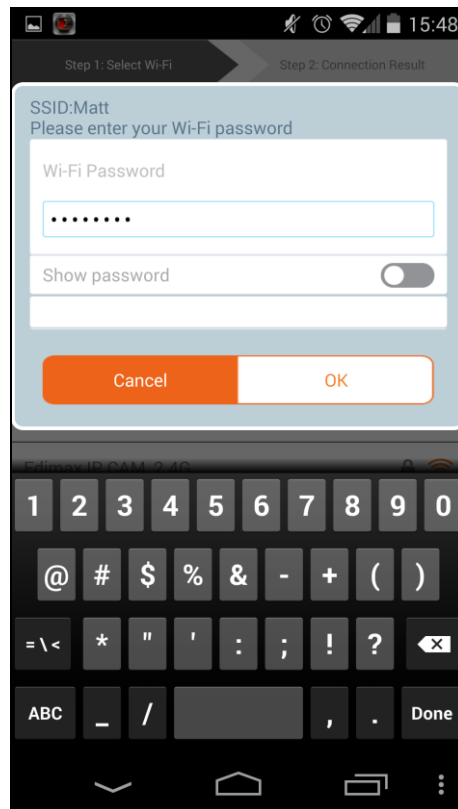
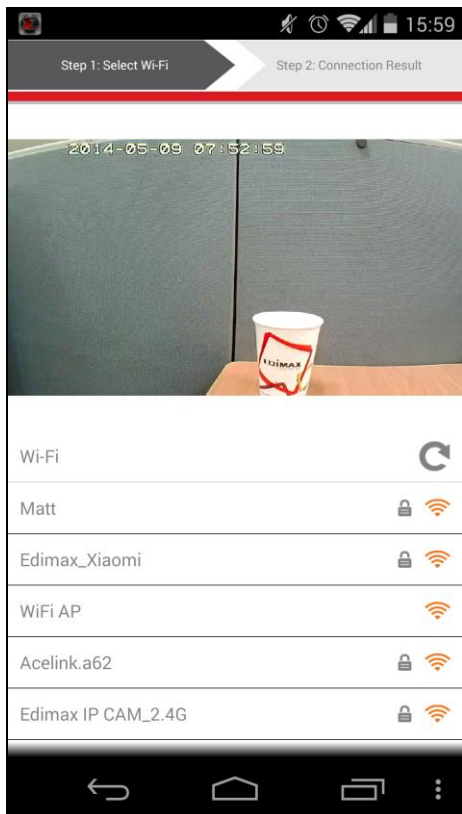

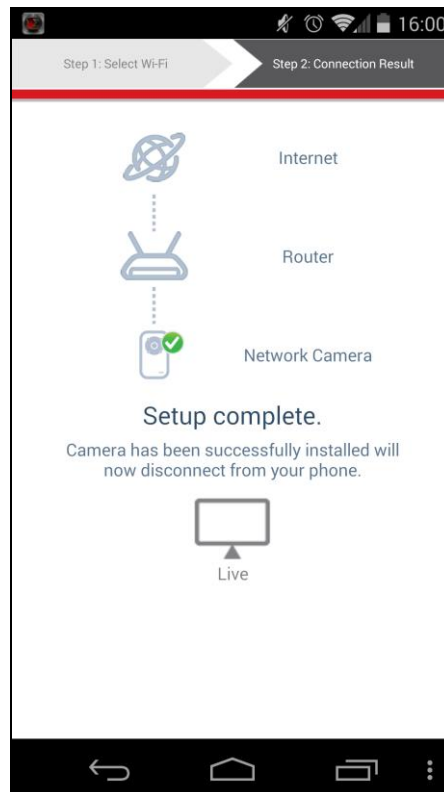
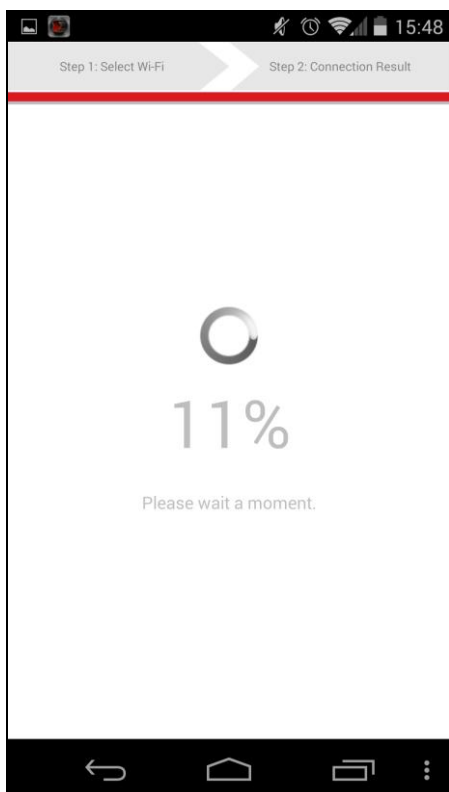

4. Patientez un moment pendant que votre caméra se connecte à la Wi-Fi. Lorsque l'écran affiche "Configuration terminée", cliquez sur l'icône "Live" pour poursuivre ou patientez quelques secondes pour continuer de façon automatique.

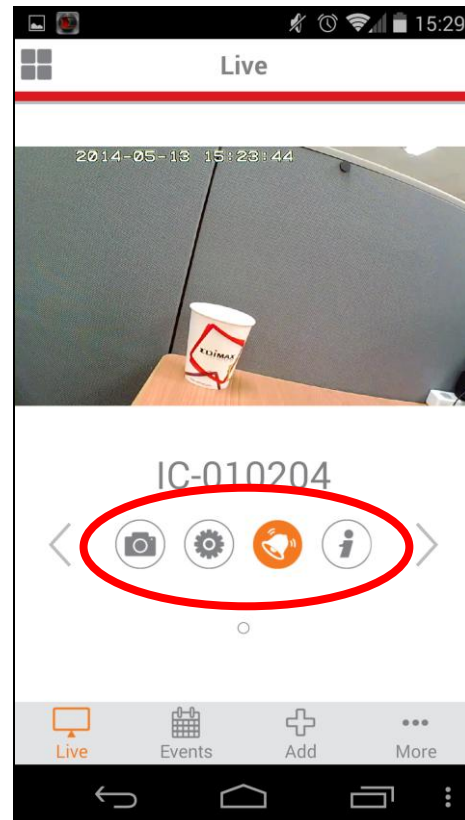
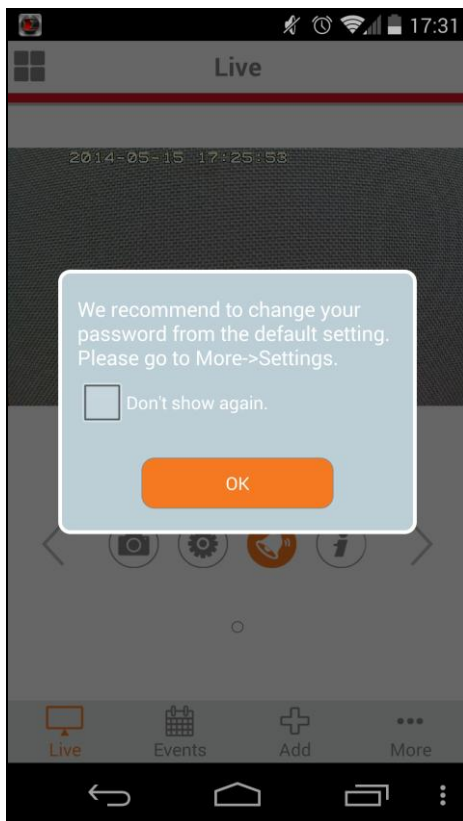

5. La configuration est terminée. Le voyant d'alimentation **vert** de la caméra doit être **allumé**. Vous devez voir la diffusion en direct provenant de votre caméra réseau et ce, chaque fois que vous êtes connecté à Internet.

 ***Nous vous recommandons de modifier le mot de passe de votre caméra. Accédez à "Plus" dans le coin inférieur droit et sélectionnez "Paramètres".***



 ***Vous pouvez configurer les paramètres et les fonctions de votre caméra en utilisant les icônes sous l'image en directe.***

III-1-2. iPhone

Utilisez l'application gratuite pour smartphone EdiView pour configurer la Wi-Fi de votre caméra et surveiller cette dernière à distance depuis n'importe quelle connexion Internet.

1. Recherchez "EdiView II" dans Apple Store puis téléchargez et installez l'application EdiView II.



2. Accédez aux paramètres Wi-Fi de votre iPhone et connectez vous au SSID de votre caméra réseau.

 **Le SSID unique de votre caméra réseau est indiqué sur l'étiquette du produit à l'arrière de la caméra. Il est composé de "EdiView.Setup**", ** étant les deux derniers caractères de l'adresse MAC unique de votre caméra.**

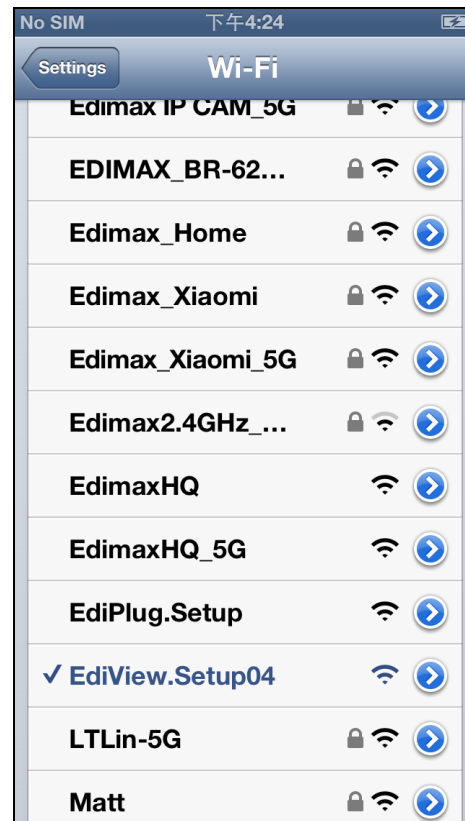

3. Ouvrez l'application EdiView et sélectionnez votre réseau Wi-Fi dans la liste. Saisissez votre mot de passe Wi-Fi avant de cliquer sur "OK".

 ***Si vous êtes invité à autoriser le forçage des notifications, merci de répondre "Oui".***

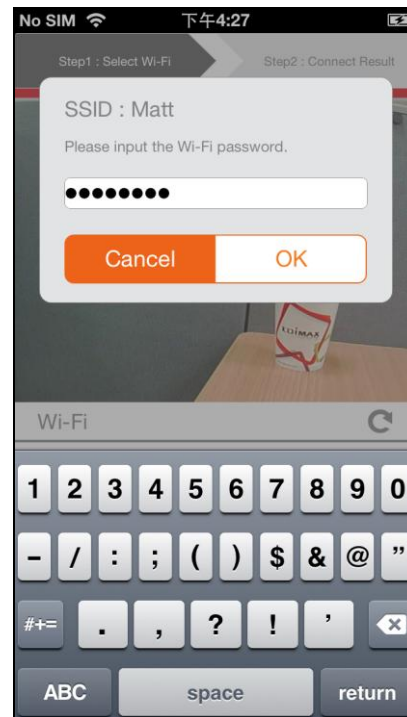
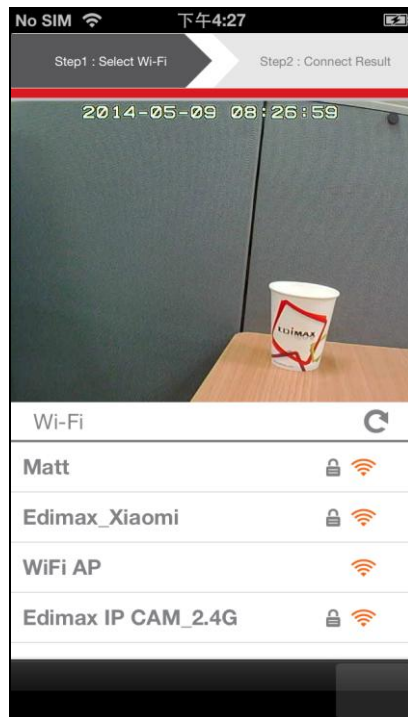

6. Patientez un moment pendant votre caméra se connecte à votre Wi-Fi. Lorsque l'écran affiche "Configuration terminée", cliquez sur l'icône "Live" pour poursuivre ou patientez un instant pour continuer de façon automatique.

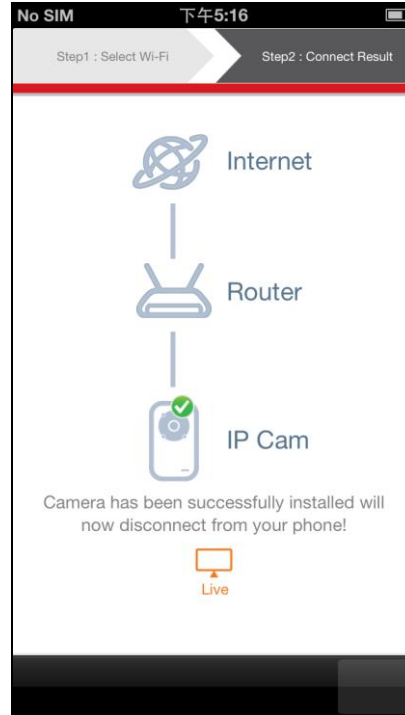
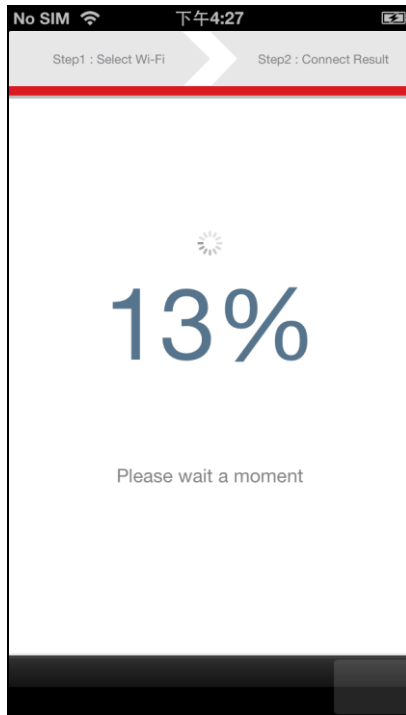

7. La configuration est terminée. Le voyant d'alimentation **vert** de la caméra doit être **allumé**. Vous devez voir la diffusion en direct provenant de votre caméra réseau et ce, chaque fois que vous êtes connecté à Internet.



Nous vous recommandons de modifier le mot de passe de votre caméra. Accédez à "Plus" dans le coin inférieur droit et sélectionnez "Paramètres".

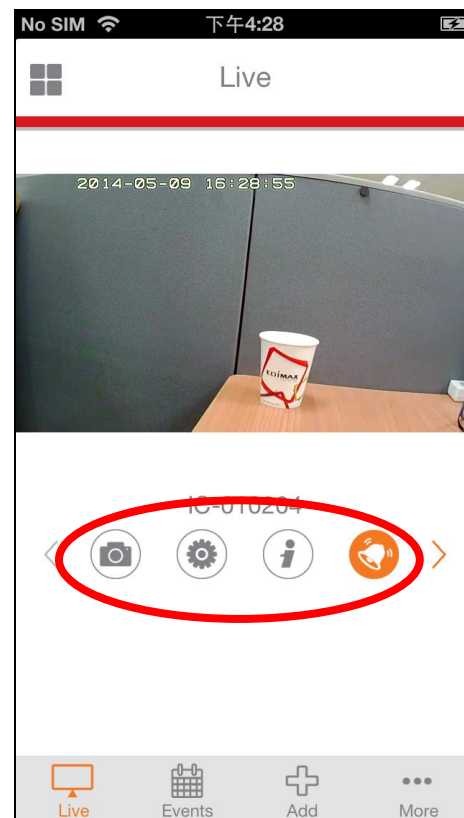
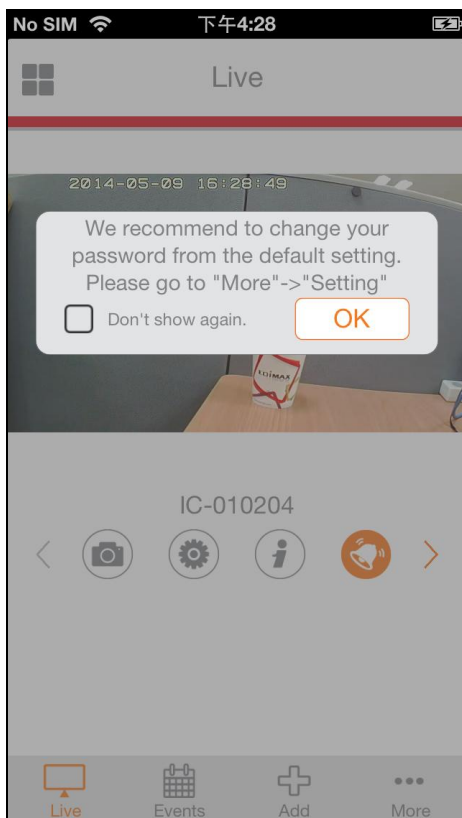



Vous pouvez configurer les paramètres et les fonctions de votre caméra en utilisant les icônes sous l'image en directe.

III-2. WPS (configuration Wi-Fi protégée)

Le bouton WPS est un moyen rapide et simple d'établir une connexion sans fil sécurisée entre votre caméra réseau et votre routeur/point d'accès sans fil.

1. Maintenez enfoncé le bouton WPS sur votre **routeur/point d'accès sans fil** pendant la durée nécessaire à l'activation de la fonction WPS.



Merci de consulter les instructions de votre routeur/point d'accès sans fil pour savoir combien de temps vous devez maintenir enfoncé le bouton WPS afin d'activer la fonction WPS.

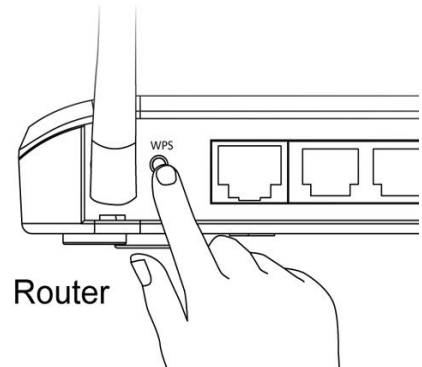

2. Dans un délai de deux minutes, appuyez sur le bouton WPS/Réinitialisation sur la caméra réseau pendant 2 à 5 secondes pour activer le WPS. Le voyant LAN **vert clignote lentement** pour indiquer que le WPS est actif.



Faites attention à ne pas appuyer trop longtemps sur la touche WPS/Réinitialisation sous peine de réinitialiser votre caméra IP (voir I-5.)

3. Les appareils établissent alors une connexion sans fil sécurisée. Le voyant LAN **vert clignote rapidement** pour indiquer que la connexion WPS a réussi.

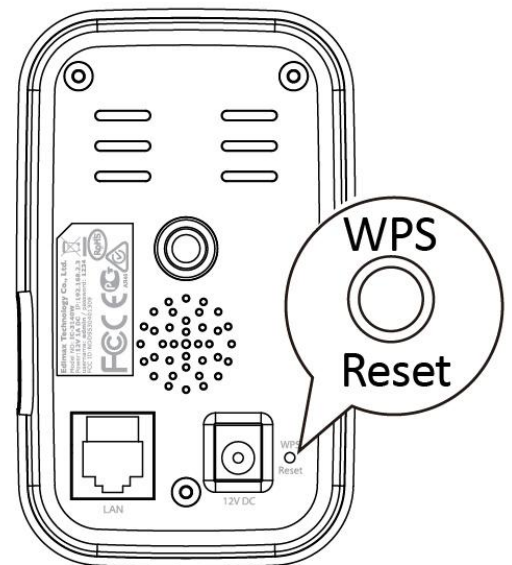

III-3. Myedimax.com

Vous pouvez utiliser l'ID Cloud Myedimax.com de votre caméra réseau pour surveiller votre caméra à distance en utilisant un navigateur Internet à partir de n'importe quelle connexion à Internet. Le voyant d'alimentation **vert** de la caméra IP **doit** être **allumé** pour que cette fonction marche.

1. Identifiez l'ID du Cloud de votre caméra réseau. L'ID du Cloud est indiqué sur l'étiquette du produit à l'arrière de la caméra (consultez la section I-4.).

 **L'ID du Cloud est une chaîne de 12 caractères comprenant des chiffres de 0 à 9 et des lettres de A à F et il est unique pour votre caméra réseau.**

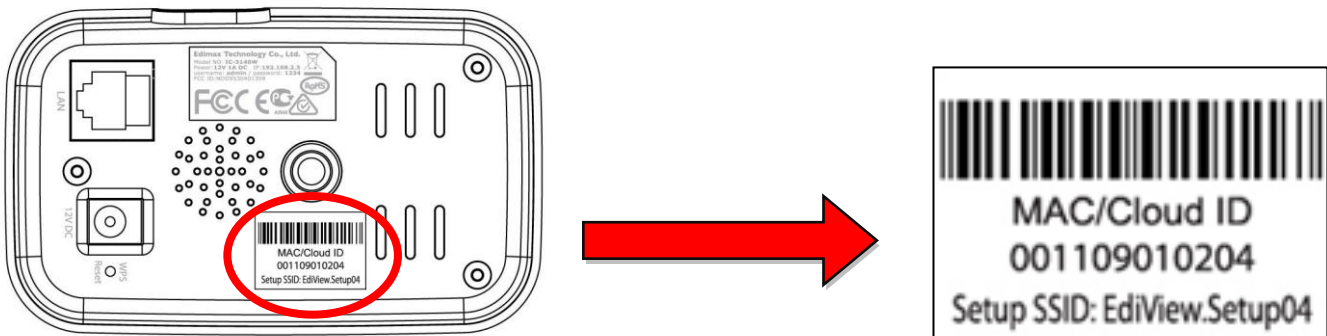

2. Saisissez **cloudID.myedimax.com** dans la barre d'adresses d'un navigateur Internet.

Par exemple, si votre cloud ID est **001109010204**, saisissez **001109010204.myedimax.com** dans votre navigateur Internet.

 **Internet Explorer est recommandé.**



- 3.** Il peut vous être demandé d'autoriser l'exécution du complément Java. Veuillez cliquer sur le message indiquant "Cliquer ici" puis cliquez sur "Exécuter le complément".

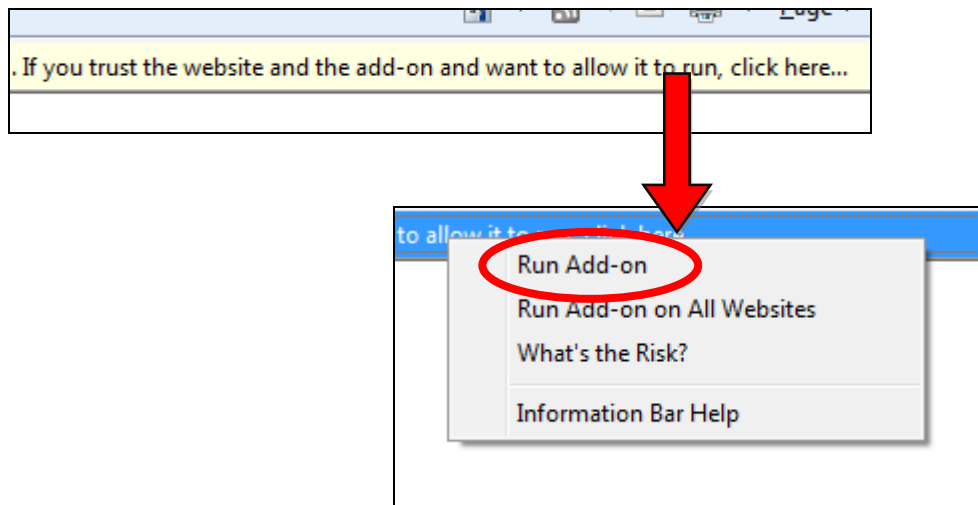

-  ***Si d'autres avertissements/invites de sécurité apparaissent, merci de sélectionner "Exécuter" ou "Autoriser" ou une action similaire en fonction de votre navigateur.***

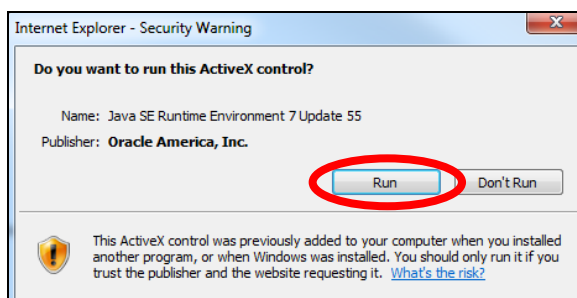

- 4.** Saisissez le mot de passe de votre caméra (Mot de passe par défaut : 1234) et cliquez sur "OK" pour voir la diffusion en direct provenant de votre caméra réseau.

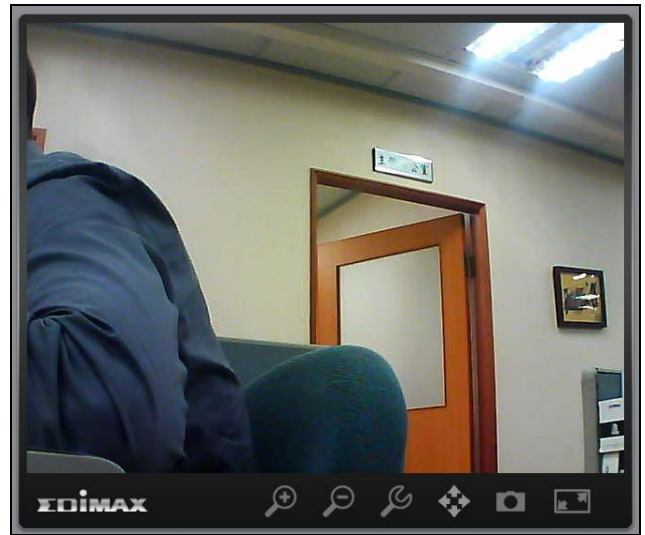
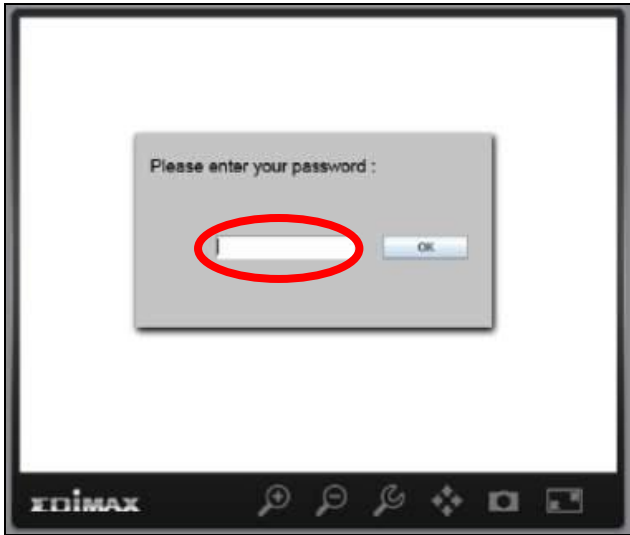

Federal Communication Commission Interference Statement

This equipment has been tested and found to comply with the limits for a Class B digital device, pursuant to Part 15 of FCC Rules. These limits are designed to provide reasonable protection against harmful interference in a residential installation. This equipment generates, uses, and can radiate radio frequency energy and, if not installed and used in accordance with the instructions, may cause harmful interference to radio communications. However, there is no guarantee that interference will not occur in a particular installation. If this equipment does cause harmful interference to radio or television reception, which can be determined by turning the equipment off and on, the user is encouraged to try to correct the interference by one or more of the following measures:

1. Reorient or relocate the receiving antenna.
2. Increase the separation between the equipment and receiver.
3. Connect the equipment into an outlet on a circuit different from that to which the receiver is connected.
4. Consult the dealer or an experienced radio technician for help.

FCC Caution

This device and its antenna must not be co-located or operating in conjunction with any other antenna or transmitter. This device complies with Part 15 of the FCC Rules. Operation is subject to the following two conditions: (1) this device may not cause harmful interference, and (2) this device must accept any interference received, including interference that may cause undesired operation. Any changes or modifications not expressly approved by the party responsible for compliance could void the authority to operate equipment.

Federal Communications Commission (FCC) Radiation Exposure Statement

This equipment complies with FCC radiation exposure set forth for an uncontrolled environment. In order to avoid the possibility of exceeding the FCC radio frequency exposure limits, human proximity to the antenna shall not be less than 2.5cm (1 inch) during normal operation.

Federal Communications Commission (FCC) RF Exposure Requirements

SAR compliance has been established in the laptop computer(s) configurations with PCMCIA slot on the side near the center, as tested in the application for certification, and can be used in laptop computer(s) with substantially similar physical dimensions, construction, and electrical and RF characteristics. Use in other devices such as PDAs or lap pads is not authorized. This transmitter is restricted for use with the specific antenna tested in the application for certification. The antenna(s) used for this transmitter must not be co-located or operating in conjunction with any other antenna or transmitter.

R&TTE Compliance Statement

This equipment complies with all the requirements of DIRECTIVE 1999/5/EC OF THE EUROPEAN PARLIAMENT AND THE COUNCIL of March 9, 1999 on radio equipment and telecommunication terminal equipment and the mutual recognition of their conformity (R&TTE). The R&TTE Directive repeals and replaces in the directive 98/13/EEC (Telecommunications Terminal Equipment and Satellite Earth Station Equipment) As of April 8, 2000.

Safety

This equipment is designed with the utmost care for the safety of those who install and use it. However, special attention must be paid to the dangers of electric shock and static electricity when working with electrical equipment. All guidelines of this and of the computer manufacture must therefore be allowed at all times to ensure the safe use of the equipment.

EU Countries Intended for Use

The ETSI version of this device is intended for home and office use in Austria, Belgium, Bulgaria, Cyprus, Czech, Denmark, Estonia, Finland, France, Germany, Greece, Hungary, Ireland, Italy, Latvia, Lithuania, Luxembourg, Malta, Netherlands, Poland, Portugal, Romania, Slovakia, Slovenia, Spain, Sweden, Turkey, and United Kingdom. The ETSI version of this device is also authorized for use in EFTA member states: Iceland, Liechtenstein, Norway, and Switzerland.

EU Countries Not Intended for Use

None

EU Declaration of Conformity

- English:** This equipment is in compliance with the essential requirements and other relevant provisions of Directive 2004/108/EC, 2006/95/EC, 2009/125/EC.
- French:** Cet équipement est conforme aux exigences essentielles et autres dispositions de la directive 2004/108/EC, 2006/95/EC, 2009/125/EC
- Czechian:** Toto zařízení je v souladu se základními požadavky a ostatními příslušnými ustanoveními směrnic 2004/108/EC, 2006/95/EC, 2009/125/EC.
- Polish:** Urządzenie jest zgodne z ogólnymi wymaganiami oraz szczególnymi warunkami określonymi Dyrektywą UE 2004/108/EC, 2006/95/EC, 2009/125/EC
- Romanian:** Acest echipament este în conformitate cu cerințele esențiale și alte prevederi relevante ale Directivei 2004/108/EC, 2006/95/EC, 2009/125/EC.
- Russian:** Это оборудование соответствует основным требованиям и положениям Директивы 2004/108/EC, 2006/95/EC, 2009/125/EC.
- Magyar:** Ez a berendezés megfelel az alapvető követelményeknek és más vonatkozó irányelveknek 2004/108/EC, 2006/95/EC, 2009/125/EC
- Türkçe:** Bu cihaz 2004/108/EC, 2006/95/EC, 2009/125/EC direktifleri zorunlu istekler ve diğer hükümlerle ile uyumludur.
- Ukrainian:** Обладнання відповідає вимогам і умовам директиви 2004/108/EC, 2006/95/EC, 2009/125/EC.
- Slovakian:** Toto zariadenie spĺňa základné požiadavky a ďalšie príslušné ustanovenia smerníc 2004/108/EC, 2006/95/EC, 2009/125/EC.
- German:** Dieses Gerät erfüllt die Voraussetzungen gemäß den Richtlinien 2004/108/EC, 2006/95/EC, 2009/125/EC.
- Spanish:** El presente equipo cumple los requisitos esenciales de la Directiva 2004/108/EC, 2006/95/EC, 2009/125/EC.
- Italian:** Questo apparecchio è conforme ai requisiti essenziali e alle altre disposizioni applicabili della Direttiva 2004/108/EC, 2006/95/EC, 2009/125/EC.
- Dutch:** Dit apparaat voldoet aan de essentiële eisen en andere van toepassing zijnde bepalingen van richtlijn 2004/108/EC, 2006/95/EC, 2009/125/EC.
- Portugese:** Este equipamento cumpre os requisitos essenciais da Directiva 2004/108/EC, 2006/95/EC, 2009/125/EC
- Norwegian:** Dette utstyret er i samsvar med de viktigste kravene og andre relevante regler i Direktiv 2004/108/EC, 2006/95/EC, 2009/125/EC.
- Swedish:** Denna utrustning är i överensstämmelse med de väsentliga kraven och övriga relevanta bestämmelser i direktiv 2004/108/EC, 2006/95/EC, 2009/125/EC.
- Danish:** Dette udstyr er i overensstemmelse med de væsentligste krav og andre relevante forordninger i direktiv 2004/108/EC, 2006/95/EC, 2009/125/EC.
- Finnish:** Tämä laite täyttää direktiivien 2004/108/EC, 2006/95/EC, 2009/125/EC oleelliset vaatimukset ja muut asiaankuuluvat määräykset.

FOR USE IN 



WEEE Directive & Product Disposal



At the end of its serviceable life, this product should not be treated as household or general waste. It should be handed over to the applicable collection point for the recycling of electrical and electronic equipment, or returned to the supplier for disposal.

Declaration of Conformity

We, Edimax Technology Co., Ltd., declare under our sole responsibility, that the equipment described below complies with the requirements of the European R&TTE directive (1999/5/EC, 2006/95/EC)

Equipment: Internet Camera
Model No.: IC-3140W

The following European standards for essential requirements have been followed:

Spectrum : ETSI EN 300 328 V1.8.1 (2012-06);
EMC : EN 301 489-1 V1.9.2 (2011-09)
EN 301 489-17 V2.2.1 (2012-09)
EMF : EN 62311:2008
Safety(LVD) : IEC 60950-1:2005 (2nd Edition); Am 1:2009
EN 60950-1 : 2006 + A11:2009 + A1:2010 + A12:2011

Edimax Technology Europe B.V.
Fijenhof 2,
5652 AE Eindhoven,
THE NETHERLANDS

a company of :
Edimax Technology Co., Ltd.,
No. 3, Wu Chuan 3rd Road,
Wu-Ku Industrial Park,
New Taipei City, Taiwan

Printed Name: Vivian Ma
Title: Director
Edimax Technology Europe B.V.

Date of Signature: June, 2014

Signature:



Printed Name: Albert Chang

Title:

Director

Edimax Technology Co., Ltd.



Notice According to GNU General Public License Version 2

This product includes software that is subject to the GNU General Public License version 2. The program is free software and distributed without any warranty of the author. We offer, valid for at least three years, to give you, for a charge no more than the costs of physically performing source distribution, a complete machine-readable copy of the corresponding source code.

Das Produkt beinhaltet Software, die den Bedingungen der GNU/GPL-Version 2 unterliegt. Das Programm ist eine sog. „Free Software“, der Autor stellt das Programm ohne irgendeine Gewährleistungen zur Verfügung. Wir bieten Ihnen für einen Zeitraum von drei Jahren an, eine vollständige maschinenlesbare Kopie des Quelltextes der Programme zur Verfügung zu stellen – zu nicht höheren Kosten als denen, die durch den physikalischen Kopiervorgang anfallen.

GNU GENERAL PUBLIC LICENSE

Version 2, June 1991

Copyright (C) 1989, 1991 Free Software Foundation, Inc. 51 Franklin Street, Fifth Floor, Boston, MA 02110-1301, USA
Everyone is permitted to copy and distribute verbatim copies of this license document, but changing it is not allowed.

Preamble

The licenses for most software are designed to take away your freedom to share and change it. By contrast, the GNU General Public License is intended to guarantee your freedom to share and change free software--to make sure the software is free for all its users. This General Public License applies to most of the Free Software Foundation's software and to any other program whose authors commit to using it. (Some other Free Software Foundation software is covered by the GNU Lesser General Public License instead.) You can apply it to your programs, too.

When we speak of free software, we are referring to freedom, not price. Our General Public Licenses are designed to make sure that you have the freedom to distribute copies of free software (and charge for this service if you wish), that you receive source code or can get it if you want it, that you can change the software or use pieces of it in new free programs; and that you know you can do these things.

To protect your rights, we need to make restrictions that forbid anyone to deny you these rights or to ask you to surrender the rights. These restrictions translate to certain responsibilities for you if you distribute copies of the software, or if you modify it.

For example, if you distribute copies of such a program, whether gratis or for a fee, you must give the recipients all the rights that you have. You must make sure that they, too, receive or can get the source code. And you must show them these terms so they know their rights.

We protect your rights with two steps: (1) copyright the software, and (2) offer you this license which gives you legal permission to copy, distribute and/or modify the software.

Also, for each author's protection and ours, we want to make certain that everyone understands that there is no warranty for this free software. If the software is modified by someone else and passed on, we want its recipients to know that what they have is not the original, so that any problems introduced by others will not reflect on the original authors' reputations.

Finally, any free program is threatened constantly by software patents. We wish to avoid the danger that redistributors of a free program will individually obtain patent licenses, in effect making the program proprietary. To prevent this, we have made it clear that any patent must be licensed for everyone's free use or not licensed at all.

The precise terms and conditions for copying, distribution and modification follow.

TERMS AND CONDITIONS FOR COPYING, DISTRIBUTION AND MODIFICATION

0. This License applies to any program or other work which contains a notice placed by the copyright holder saying it may be distributed under the terms of this General Public License. The "Program", below, refers to any such program or work, and a "work based on the Program" means either the Program or any derivative work under copyright law: that is to say, a work containing the Program or a portion of it, either verbatim or with modifications and/or translated into another language. (Hereinafter, translation is included without limitation in the term "modification".) Each licensee is addressed as "you".

Activities other than copying, distribution and modification are not covered by this License; they are outside its scope. The act of running the Program is not restricted, and the output from the Program is covered only if its contents constitute a work based on the Program (independent of having been made by running the Program). Whether that is true depends on what the Program does.

1. You may copy and distribute verbatim copies of the Program's source code as you receive it, in any medium, provided that you conspicuously and appropriately publish on each copy an appropriate copyright notice and disclaimer of warranty; keep

intact all the notices that refer to this License and to the absence of any warranty; and give any other recipients of the Program a copy of this License along with the Program.

You may charge a fee for the physical act of transferring a copy, and you may at your option offer warranty protection in exchange for a fee.

2. You may modify your copy or copies of the Program or any portion of it, thus forming a work based on the Program, and copy and distribute such modifications or work under the terms of Section 1 above, provided that you also meet all of these conditions:

- a) You must cause the modified files to carry prominent notices stating that you changed the files and the date of any change.
- b) You must cause any work that you distribute or publish, that in whole or in part contains or is derived from the Program or any part thereof, to be licensed as a whole at no charge to all third parties under the terms of this License.
- c) If the modified program normally reads commands interactively when run, you must cause it, when started running for such interactive use in the most ordinary way, to print or display an announcement including an appropriate copyright notice and a notice that there is no warranty (or else, saying that you provide a warranty) and that users may redistribute the program under these conditions, and telling the user how to view a copy of this License. (Exception: if the Program itself is interactive but does not normally print such an announcement, your work based on the Program is not required to print an announcement.)

These requirements apply to the modified work as a whole. If identifiable sections of that work are not derived from the Program, and can be reasonably considered independent and separate works in themselves, then this License, and its terms, do not apply to those sections when you distribute them as separate works. But when you distribute the same sections as part of a whole which is a work based on the Program, the distribution of the whole must be on the terms of this License, whose permissions for other licensees extend to the entire whole, and thus to each and every part regardless of who wrote it.

Thus, it is not the intent of this section to claim rights or contest your rights to work written entirely by you; rather, the intent is to exercise the right to control the distribution of derivative or collective works based on the Program.

In addition, mere aggregation of another work not based on the Program with the Program (or with a work based on the Program) on a volume of a storage or distribution medium does not bring the other work under the scope of this License.

3. You may copy and distribute the Program (or a work based on it, under Section 2) in object code or executable form under the terms of Sections 1 and 2 above provided that you also do one of the following:

- a) Accompany it with the complete corresponding machine-readable source code, which must be distributed under the terms of Sections 1 and 2 above on a medium customarily used for software interchange; or,
- b) Accompany it with a written offer, valid for at least three years, to give any third party, for a charge no more than your cost of physically performing source distribution, a complete machine-readable copy of the corresponding source code, to be distributed under the terms of Sections 1 and 2 above on a medium customarily used for software interchange; or,
- c) Accompany it with the information you received as to the offer to distribute corresponding source code. (This alternative is allowed only for noncommercial distribution and only if you received the program in object code or executable form with such an offer, in accord with Subsection b above.)

The source code for a work means the preferred form of the work for making modifications to it. For an executable work, complete source code means all the source code for all modules it contains, plus any associated interface definition files, plus the scripts used to control compilation and installation of the executable. However, as a special exception, the source code distributed need not include anything that is normally distributed (in either source or binary form) with the major components (compiler, kernel, and so on) of the operating system on which the executable runs, unless that component itself accompanies the executable.

If distribution of executable or object code is made by offering access to copy from a designated place, then offering equivalent access to copy the source code from the same place counts as distribution of the source code, even though third parties are not compelled to copy the source along with the object code.

4. You may not copy, modify, sublicense, or distribute the Program except as expressly provided under this License. Any attempt otherwise to copy, modify, sublicense or distribute the Program is void, and will automatically terminate your rights under this License. However, parties who have received copies, or rights, from you under this License will not have their licenses terminated so long as such parties remain in full compliance.

5. You are not required to accept this License, since you have not signed it. However, nothing else grants you permission to modify or distribute the Program or its derivative works. These actions are prohibited by law if you do not accept this License. Therefore, by modifying or distributing the Program (or any work based on the Program), you indicate your acceptance of this License to do so, and all its terms and conditions for copying, distributing or modifying the Program or works based on it.

6. Each time you redistribute the Program (or any work based on the Program), the recipient automatically receives a license from the original licensor to copy, distribute or modify the Program subject to these terms and conditions. You may not impose any further restrictions on the recipients' exercise of the rights granted herein. You are not responsible for enforcing compliance by third parties to this License.

7. If, as a consequence of a court judgment or allegation of patent infringement or for any other reason (not limited to patent issues), conditions are imposed on you (whether by court order, agreement or otherwise) that contradict the conditions of this License, they do not excuse you from the conditions of this License. If you cannot distribute so as to satisfy simultaneously your obligations under this License and any other pertinent obligations, then as a consequence you may not distribute the Program at all. For example, if a patent license would not permit royalty-free redistribution of the Program by all those who receive copies directly or indirectly through you, then the only way you could satisfy both it and this License would be to refrain entirely from distribution of the Program.

If any portion of this section is held invalid or unenforceable under any particular circumstance, the balance of the section is intended to apply and the section as a whole is intended to apply in other circumstances.

It is not the purpose of this section to induce you to infringe any patents or other property right claims or to contest validity of any such claims; this section has the sole purpose of protecting the integrity of the free software distribution system, which is implemented by public license practices. Many people have made generous contributions to the wide range of software distributed through that system in reliance on consistent application of that system; it is up to the author/donor to decide if he or she is willing to distribute software through any other system and a licensee cannot impose that choice.

This section is intended to make thoroughly clear what is believed to be a consequence of the rest of this License.

8. If the distribution and/or use of the Program is restricted in certain countries either by patents or by copyrighted interfaces, the original copyright holder who places the Program under this License may add an explicit geographical distribution limitation excluding those countries, so that distribution is permitted only in or among countries not thus excluded. In such case, this License incorporates the limitation as if written in the body of this License.

9. The Free Software Foundation may publish revised and/or new versions of the General Public License from time to time. Such new versions will be similar in spirit to the present version, but may differ in detail to address new problems or concerns.

Each version is given a distinguishing version number. If the Program specifies a version number of this License which applies to it and "any later version", you have the option of following the terms and conditions either of that version or of any later version published by the Free Software Foundation. If the Program does not specify a version number of this License, you may choose any version ever published by the Free Software Foundation.

10. If you wish to incorporate parts of the Program into other free programs whose distribution conditions are different, write to the author to ask for permission. For software which is copyrighted by the Free Software Foundation, write to the Free Software Foundation; we sometimes make exceptions for this. Our decision will be guided by the two goals of preserving the free status of all derivatives of our free software and of promoting the sharing and reuse of software generally.

NO WARRANTY

11. BECAUSE THE PROGRAM IS LICENSED FREE OF CHARGE, THERE IS NO WARRANTY FOR THE PROGRAM, TO THE EXTENT PERMITTED BY APPLICABLE LAW. EXCEPT WHEN OTHERWISE STATED IN WRITING THE COPYRIGHT HOLDERS AND/OR OTHER PARTIES PROVIDE THE PROGRAM "AS IS" WITHOUT WARRANTY OF ANY KIND, EITHER EXPRESSED OR IMPLIED, INCLUDING, BUT NOT LIMITED TO, THE IMPLIED WARRANTIES OF MERCHANTABILITY AND FITNESS FOR A PARTICULAR PURPOSE. THE ENTIRE RISK AS TO THE QUALITY AND PERFORMANCE OF THE PROGRAM IS WITH YOU. SHOULD THE PROGRAM PROVE DEFECTIVE, YOU ASSUME THE COST OF ALL NECESSARY SERVICING, REPAIR OR CORRECTION.

12. IN NO EVENT UNLESS REQUIRED BY APPLICABLE LAW OR AGREED TO IN WRITING WILL ANY COPYRIGHT HOLDER, OR ANY OTHER PARTY WHO MAY MODIFY AND/OR REDISTRIBUTE THE PROGRAM AS PERMITTED ABOVE, BE LIABLE TO YOU FOR DAMAGES, INCLUDING ANY GENERAL, SPECIAL, INCIDENTAL OR CONSEQUENTIAL DAMAGES ARISING OUT OF THE USE OR INABILITY TO USE THE PROGRAM (INCLUDING BUT NOT LIMITED TO LOSS OF DATA OR DATA BEING RENDERED INACCURATE OR LOSSES SUSTAINED BY YOU OR THIRD PARTIES OR A FAILURE OF THE PROGRAM TO OPERATE WITH ANY OTHER PROGRAMS), EVEN IF SUCH HOLDER OR OTHER PARTY HAS BEEN ADVISED OF THE POSSIBILITY OF SUCH DAMAGES.



ΣDIMAX
NETWORKING PEOPLE TOGETHER