

AIRQUALITY MONITOR

MODEL NO.: AR112N

USER'S MANUAL

SECTION 1 INTRODUCTION

Congratulations on your purchasing the AR112N Air Quality Monitor.

The AR112N is an indispensable household appliance for better living. It helps improve your life quality and health by providing significant information on the concentration of harmful VOC (volatile organic compounds) gases in the environment. In addition to warning you against bad air quality, it also keeps you constantly informed of the indoor temperature and humidity.

ABOUT VOC GASES

VOC gases are invisible to the human eye. They are chemical compounds very often found in building materials, household detergents and bleaches, cigarettes, material additives and adhesives and the like. Here is a brief look at the most common sources of household VOC gases:

MAJOR HOUSEHOLD SOURCES	EXAMPLES
Building Materials	Insulating materials, vinyl or plastic wall coverings, construction adhesives, plastic piping and gypsum boards
Cleansers	Aerosol bathroom cleansers, window cleansers, oven cleansers, abrasive cleansers, dishwashing detergents, spot removers and room deodorants
Paints	Oil, urethane and acrylic paints, varnishes, paint thinners and removers
Adhesives	Rubber cement and adhesives, floor tile adhesives, ceramic adhesives and carpet adhesives
Cosmetics	Deodorants, talc, rubbing alcohol and hair sprays
Pesticides	Roach, flea and rat killers, mold and mildew inhibitors, plant insecticides, moth repellents and fungicides
Appliances	Heaters, gas cooking stoves, wood-burning stoves and fireplaces
Others	Tobacco and cigarette smokes, vehicular exhaust, upholstery, draperies and carpets

POTENTIAL HEALTH HARZARDS

These gases cause pollution to the environment and when breathed in high concentrations over a long period of time, may cause harm to the human body. Here are some of the potential health hazards caused by common VOC gases:

Sources	VOC Gases	Affected Organs
Vinyl tiles	Benzyl chloride	Central nervous system, liver, kidney, eye and respiratory tract
Paints, solvents, resins and cigarette smokes	Benzene and styrene (carcinogens)	Respiratory tract
Paint removers, deodorizers and moth crystals	Dichloromethane and 1,4-Dichlorobenzene (both narcotic)	Central nervous system, liver, kidney, eye and respiratory tract
Polyurethane foam aerosols, solvents and cleansing compounds	Trichloroethene and toluene diisocyanate (carcinogens)	Central nervous system
Adhesives, vinyl floor covering, wallpaper, tobacco smokes, kerosene heaters	Toluene (narcotic)	Central nervous system
Pesticides, varnishes and pharmaceuticals	Xylenes (narcotic)	Central nervous system, heart, liver and kidney

SOLUTIONS

As VOC gases are not particles that can be filtered by a household air filter, the best ways to guard against such harmful VOC gases are adequate supply of fresh air, constant ventilation and a good air quality monitor to alert you to the existence of such gases.

BEFORE YOU BEGIN



- Please read carefully before you start to use this unit.
- This unit alerts you to the quality of air you are breathing in. It does not necessarily reflect the concentration of a particular type of VOC gases.
- This unit is designed to response to a wide range of VOC gases. When the [] is activated, it does not necessarily mean you are in immediate bodily danger. It means the room needs immediate ventilation.
- Always read the instructions of chemicals, materials and appliances used in the household careful. They may contain important information on the pos sible danger or health hazards they may affect when abused.

PRECAUTIONS

Safety warnings, precautions or rules are embedded throughout the manual to help you use this product safely. Take heed of the advice to avoid injuries, fire, electrocution, damage or other accidents. Ignoring this may result in serious injuries or worse accidents.

SECTION 2 PRODUCT FEATURES AND OPERATION

PRODUCT FEATURES

 Generally prohibited	<ul style="list-style-type: none"> - Use adaptor other than AC 100V may cause fire on electric shock. - Do not subject the internal components to water or foreign objects. - Do not install the unit in bathrooms or places exposed to rain or excessive humidity. - Do not drop the product onto the ground or subject it to excessive shock to avoid damage. - Do not change the specifications of the provided power cord or damage it. And avoid placing furniture or heavy objects on top of the power cord. - Do not overload the power source. Use an unoccupied wall socket. - Do not pull by the cord when disconnecting the unit from the power socket. - Do not touch the power socket or power cord with wet hands. - Avoid placing the power cord too close to heat sources that may cause damage to the protective layer. - Discontinue use when the power contact is loose or when the power cord radiates heat. - Do not cover the unit with cloths, blankets or similar objects that may block the dissipation of heat generated in normal operation. - Do not install the unit near cooking utensils, humidifiers, heaters or places subject to excessive or direct heat, cold or dust.
 Do not disassemble	<ul style="list-style-type: none"> - Do not tamper with the unit's internal components.
 Important	<ul style="list-style-type: none"> - Disconnect the unit from the wall socket when the internal components are in contact with water or foreign objects. - Discontinue use when the internal wires of the power cord are exposed. - Disconnect the unit from the power socket in times of thunder. - Discontinue use when the unit or the power socket is damaged. - Disconnect the unit from the power socket when the unit malfunctions or smoke or smell radiates from the unit.

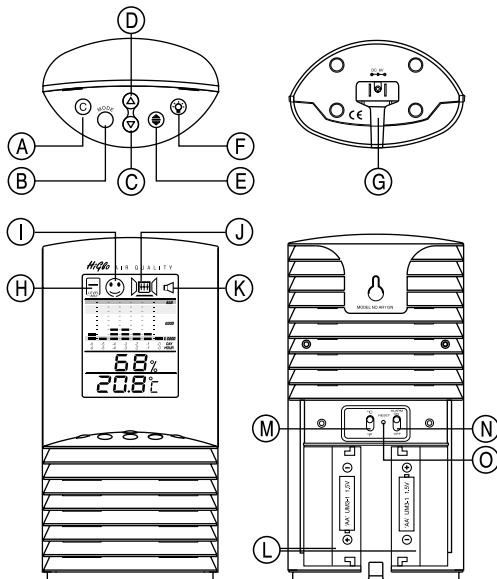

A. [C] BUTTON

Presses and holds to clear the memory.

B. MODE BUTTON

Changes the display interval for the air quality bar graph.

C. [▽] BUTTON

Changes between the current and minimum temperature and humidity in memory.

Presses once to decrease the sensitivity of the unit.

D. [△] BUTTON

Changes between the current and maximum temperature and humidity in memory.

Presses once to increase the sensitivity of the unit.

E. [⊕] BUTTON

Presses to enter the sensitivity level adjustment of the unit.

F. LIGHT BUTTON

Turns on the backlight for five seconds.

G. POWER ADAPTER CONNECTOR

Power supply for the unit.

H. LEVEL ADJ INDICATOR

Indicates the sensitivity level of the unit.

I. AIR QUALITY INDICATOR

Indicates the air quality.

J. VENTILATION INDICATOR

Appears when the room needs ventilation.

K. [🔊] BAD AIR ALARM INDICATOR

Appears when the alarm is activated.

L. BATTERY COMPARTMENT

Accommodates two AA-sized batteries.

M. °C/°F SWITCH

Changes between degree Centigrade (°C) and Fahrenheit (°F).

N. ALARM ON/OFF SWITCH

Turns on or off the bad air alarm.

O. RESET BUTTON

Erases all memory and start afresh.

POWER REQUIREMENT

The unit comes with a power adapter which should be connected to the unit to provide adequate power for air sampling.

To connect the power adapter, plug it into the power adapter connector on the base of the unit before connecting it to a wall socket.

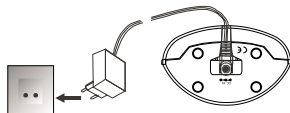

The unit also takes two optional AA-sized batteries. To install the batteries,

1. Remove the battery compartment door.
2. Insert new batteries.
3. Replace the battery compartment door.

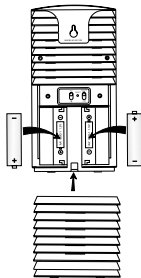

NOTE: Do not mix fresh and old batteries, or batteries of different specifications. If operated alone on batteries, the unit will only take temperature and humidity readings. The air sampling function will be disabled. Replace these batteries when the display becomes dim.

HOW TO INSTALL THE UNIT

The AR112N Air Quality Monitor is designed to sample and determine the level of VOC gases in the room that it monitors. This unit is for indoor use only.

As most VOC gases enter the human body through breathing, it is recommended you mount or place it at eye level of the user using the recessed mounting hole or retractable table stand.

For instance, if the unit is to be installed in the living room, it should be installed at the eye level of a standing adult. If the unit is to be used in the kid's room, it should be installed at the eye level of the kid sitting on the bed.

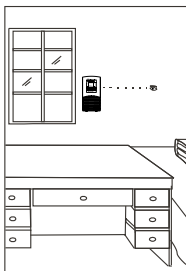

AIR SAMPLING

Once connected to the power, the AR112N starts to initiate. The whole column on the far right of the bar graph will light up for approximately 10 minutes.

Then the unit will sample and display air quality according to the set interval and sensitivity. A normal dynamic display consists of seven columns of the bar graph lighting up one after another. Then the display will freeze for a few seconds and start again. The current temperature and humidity will be displayed at all times.

When operated solely on batteries, the unit will not be able to sample air quality. Only the temperature and humidity will be shown and the bottom row bar graph will flash.

HOW TO READ AIR QUALITY

The air quality is displayed on the bar graph and rated very good, good or bad. An indicator will light up to show what the air quality is.

Very Good	Good	Bad





You can select to display the average air quality in three intervals: 70 seconds, 7 hours or 7 days. To do so, press MODE repeatedly. When the 7-hour or 7-day interval is selected, the 0 column means the current hour or day and each column to its left means a previous hour or day, respectively. When the 70-second interval is selected,

the current 10 seconds are on the column on the far right. Each column to its left means 10 previous seconds.

HOW TO ADJUST SENSITIVITY LEVEL

The sensitivity level affects how the unit rates the air quality. You may have to adjust the sensitivity according to the actual environment of the installation or specific needs.

To adjust the sensitivity level,

1. Press []. The [] indicator will blink.
2. Use [] or [] to select the desired level.
3. Press [] to exit. The unit will also return to normal display after 10 seconds.

Note that the new sensitivity level only applies to future samplings but not the old ones in memory.



BAD AIR WARNING

When the air quality is considered bad, the [] indicator will appear to show the room needs immediate ventilation. These indicators will remain lit until the air quality improves.

If the ALARM ON/OFF switch is set on ON, an alarm will also go off continuously for 10 seconds. If the air quality does not improve, a beep will be emitted every minute for the next 7 minutes and every 10 minutes afterward. To stop the alarm, press any button. To disable the feature, set the switch to OFF.

TEMPERATURE AND HUMIDITY

The current temperature and humidity are displayed at all times.

To show the maximum or minimum readings in memory, press [] or [], respectively. Press the button again to go back to the current readings. The unit will also do so automatically after 5 seconds.

To clear the memory, press and hold “ C ” button for two seconds.

°C/°F SWITCH

The temperature unit is selected on the °C/°F switch. Slide the switch to °C for degree Centigrade or °F for degree Fahrenheit. The selected unit will apply to the current temperature as well as temperatures in memory.

HOW TO USE THE BACKLIGHT

Press [] to turn on the backlight for five seconds.

THE RESET BUTTON

This button is used only when the unit is operating in an unfavorable way. Use a blunt stylus to hold down the button. All memories will be erased.

SPECIFICATIONS

Temperature measurement:

Measuring range : -5°C to +50°C (+23°F to +122°F)

Operating range : 0°C to +40°C (+32°F to +104°F)

Relative humidity measurement :

Measuring range: 25%RH to 95%RH

Power :

Main : 3V AC/DC power adapter

Back up : 2 × UM-3 or “AA” 1.5V alkaline battery

Dimension : 176.5 × 91.0 × 58.0 mm (H × W × D)

Weight : 230.90g (without battery)