

User's Manual

Powerline 200M Pass-through Adapter

Index

1. Powerline Networking Installation	2
1.1 Simple step to install Powerline Networking.....	2
1.2 Application Block Diagram	3
1.3 Benefits	5
1.4 Features	5
1.5 Package Contents	5
1.6 LED Definitions.....	6
1.7 Interface Description.....	6
1.8 System Requirements.....	6
2. Powerline Networking Utility	7
2.1 Configuration Utility Setup	7
2.1.1 Installation of the Utility.....	7
2.2 Windows Configuration Utility.....	9
2.3 User Interface.....	10
2.3.1 Main Screen	10
2.3.2 Privacy Screen	14
2.4 Diagnostics Screen.....	16
2.4.1 About Screen	18
2.4.2 Preferences.....	18
3. Push Button Setting	19
4. Trouble Shooting.....	22

1. Powerline Networking Installation

1.1 Simple step to install Powerline Networking

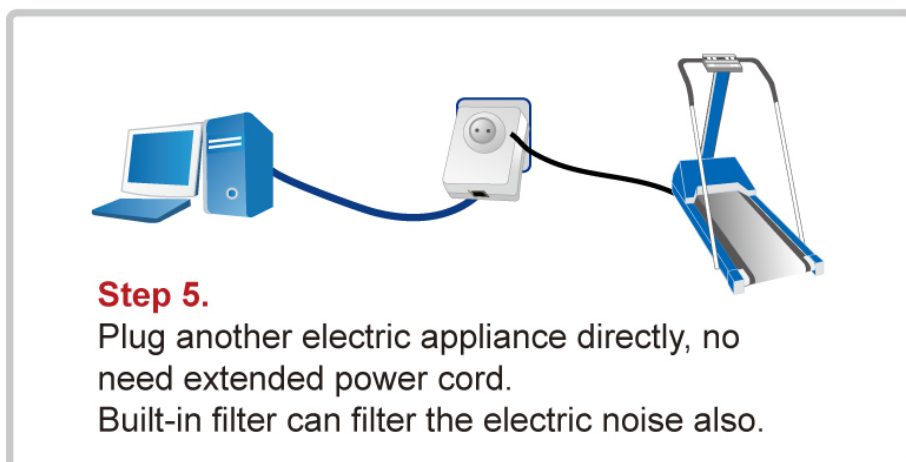
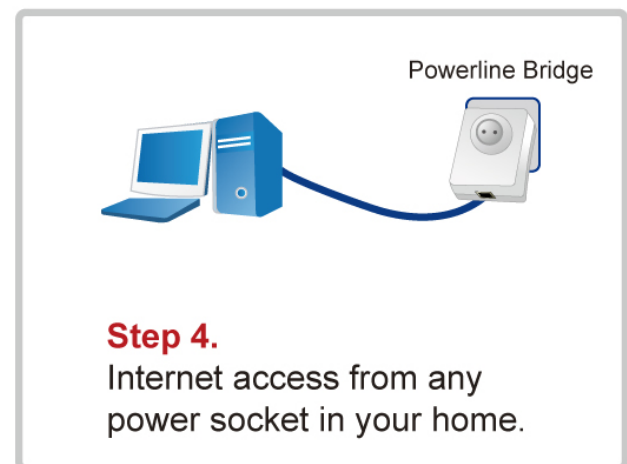
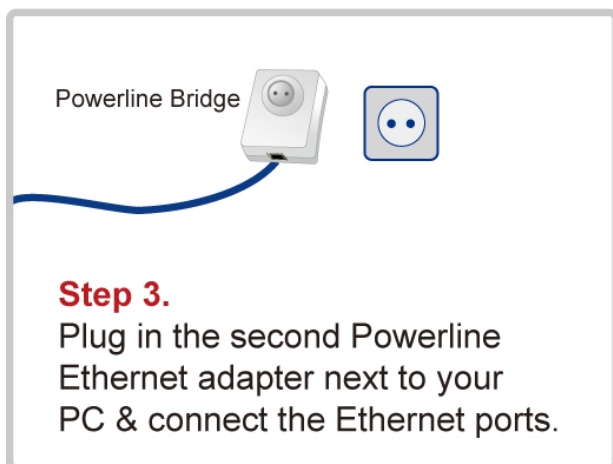
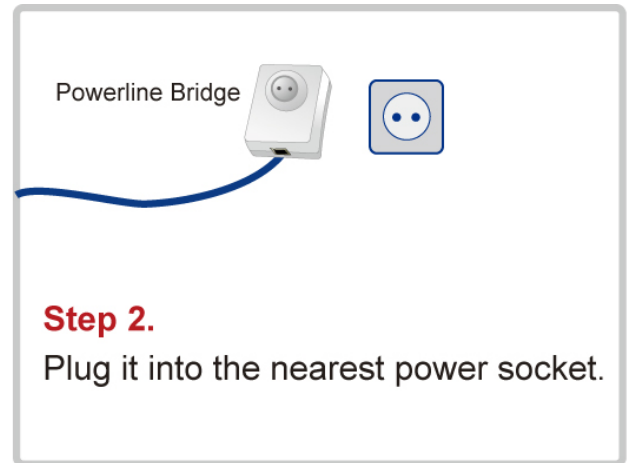
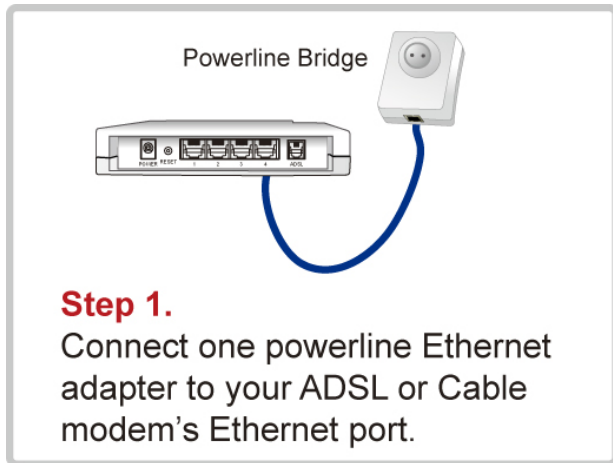

1.2 Application Block Diagram

1.2.1 Internet ADSL with one computer via power outlet

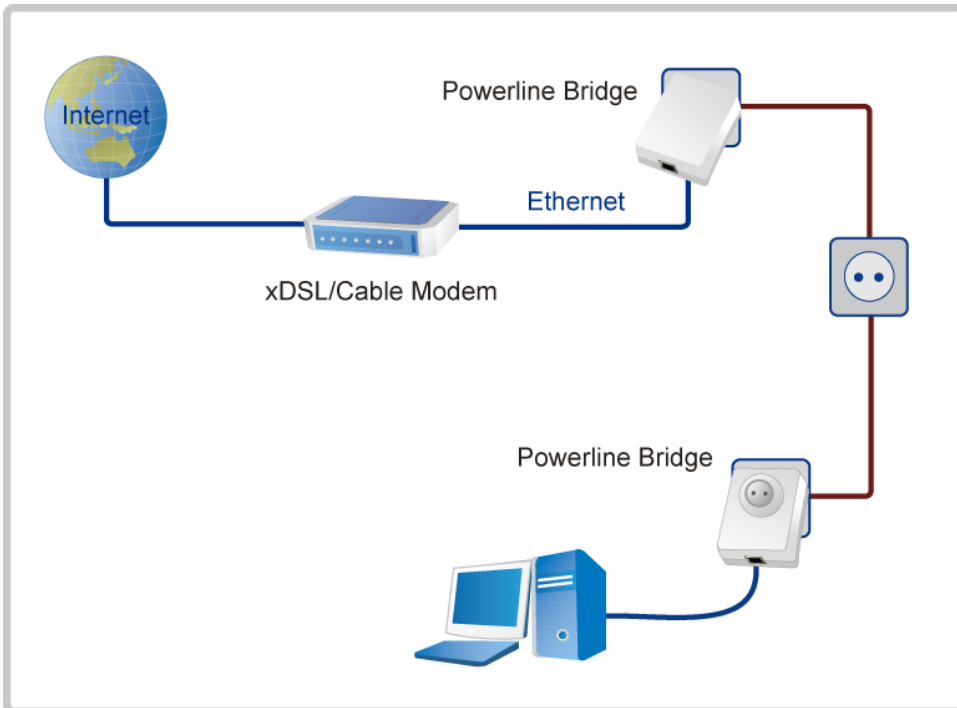

1.2.2 Online game via power outlet

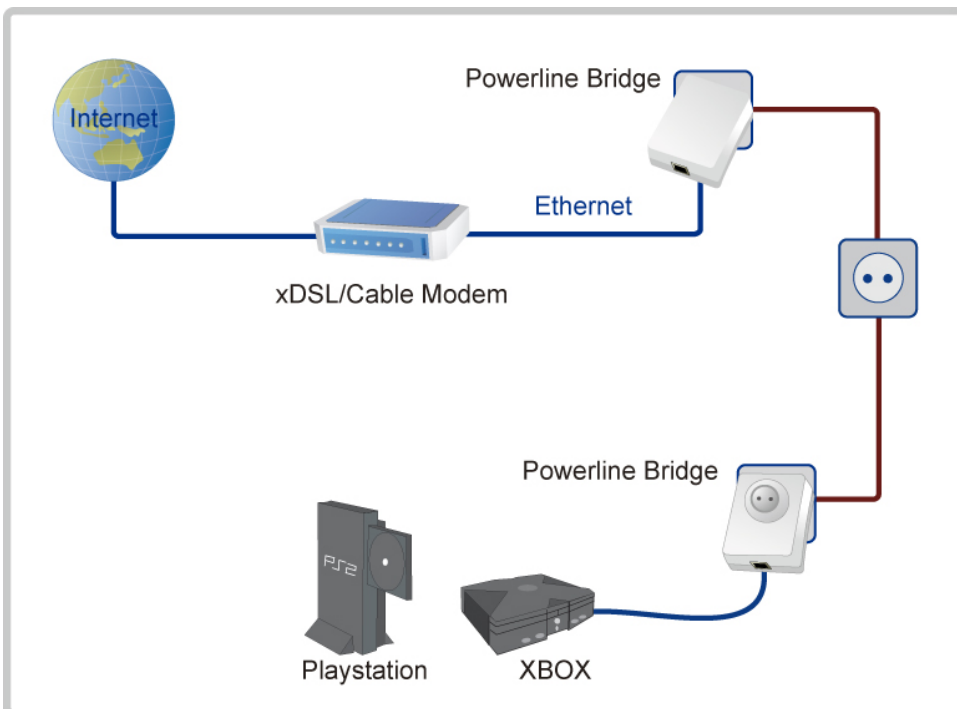

1.2.3 Internet ADSL and Home Networking via power outlet

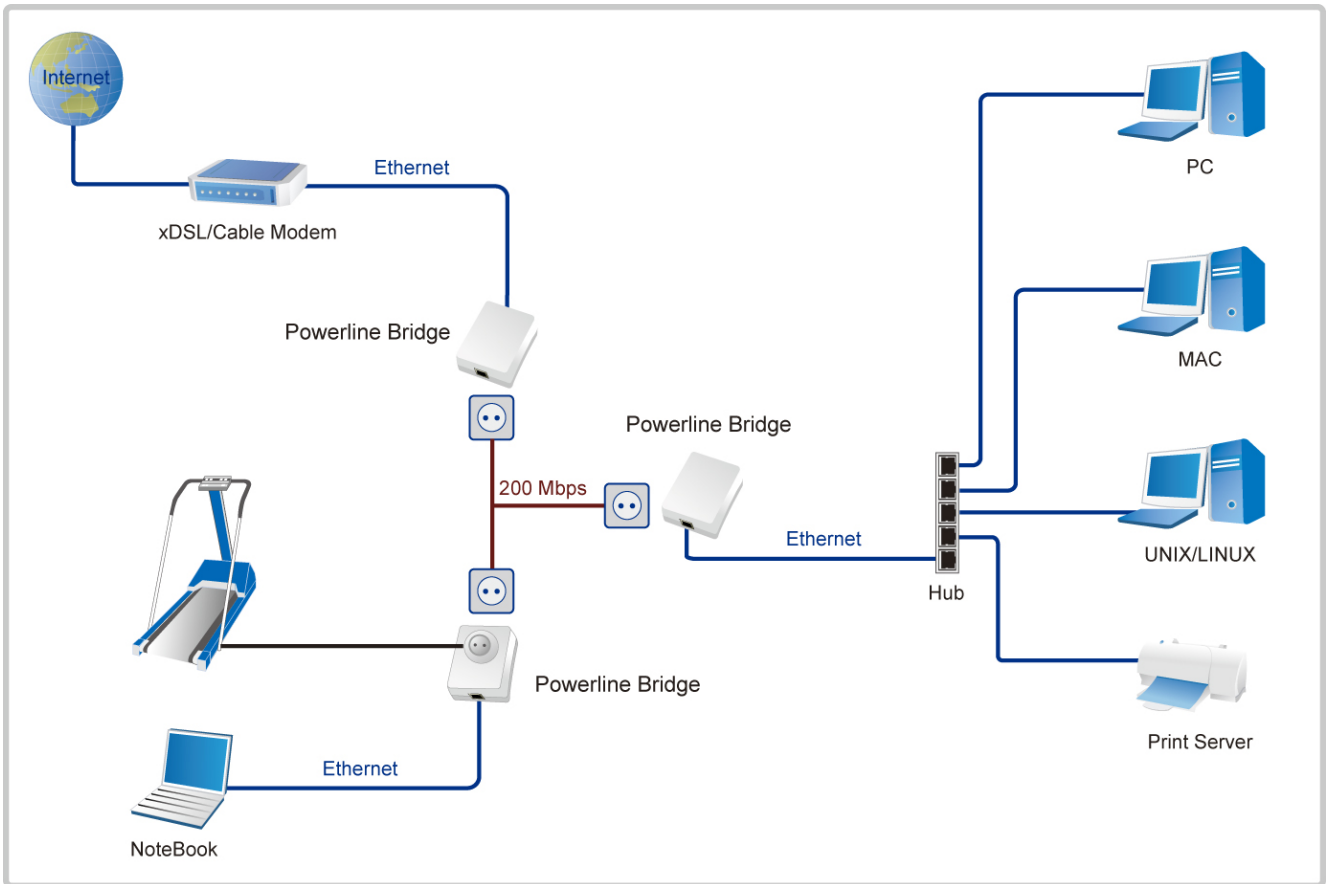

1.3 Benefits

- Data transfers at up to 200 Mbps over the household power circuit
- Ranges of 200 meters
- Built-in filter can filter out the noise from electric appliance(2 – 30Mhz)
- Provide extra power socket for electric appliance
- No need new wires for Home networking
- Deliver the benefits of Ethernet without the wiring expense
- Send even large files between PCs without long waits
- High-speed Internet and DVD-quality video streaming
- Fully compliant with IEEE 802.3, IEEE 802.3u
- Privacy through DES encryption



1.4 Features

- Use the home's existing Powerline
- Smart EuP function
- Support coexist with Powerline 85M or 14M bridges
- Easy to install
- Throughout the whole house, just use your power circuit to access the Internet or PC network
- Orthogonal Frequency Division Multiplexing for high data reliability in noisy media conditions
- Integrated Enhanced Quality of Service(QoS) features: Eight levels of prioritized random access, contention free access, and segment bursting
- Up to 200Mbps data rate on Powerline
- Provide 128-bit AES Link Encryption with key management for secure Powerline communications
- LEDs indicate status

1.5 Package Contents

- Powerline 200M Pass-through Adapter unit
- Powerline Network Management CD
- Quick Installation Guide
- Category 5 cable

1.6 LED Definitions

LED		State	Description
Powerline		ON	Powerline network activity. Powerline Link Status; Green – Good Orange – Normal Red – Poor
		OFF	Search or no Powerline network activity.
Ethernet		ON	Ethernet connection is OK. Auto switch to Normal Mode .
		Flashing	Data transferring.
		OFF	No Ethernet link. *Auto switch to Auto Standby Mode after 2 second while No Ethernet Link.
POWER		ON	Power on.
		Flashing	*Auto flashing every 0.5 second when switch to Auto Standby mode .
		OFF	Powerline off or failure.

* **Auto Standby mode:** This mode is energy saving mode, and comply with EuP directive. This device will auto to enable the Standby mode while no Ethernet Link.

1.7 Interface Description

Interface	Description
RJ-45 Port	Connect to the Ethernet Cable
Secure / Reset Button	The Button can auto secure and group the Powerline devices, and reset to factory default too. Press 2 second for auto secure. Press 10 seconds for generate new random encryption key. Press > 15 seconds for reset to factory default.
On/Off Button	Press to OFF mode the device will switch to Manual Standby mode: This mode is Fully energy saving mode, comply with EuP(ErP).
EU power socket	For extra electric appliance

1.8 System Requirements

- Ethernet device
- AC power outlet
- Windows system for encryption setup

2. Powerline Networking Utility

Note. The Powerline Device can auto detect the other powerline bridges which plug in the same power circuit, you don't need to use this powerline utility except you want to encryption all the powerline devices as the same group or you can not access the other computers.

Introduction of Configuration Utility

The Configuration Utility for Windows OS enables the user to find Powerline Ethernet devices on the Powerline network; measures data rate performance, ensures privacy, performs diagnostics and secures Powerline networks. Before install the utility, please check the windows edition of your computer. For vista 64, it need to install the vista 64 utility, you can easy to see it in the CD auto run screen. Please use the correct utility to install; otherwise it can not work properly.

2.1 Configuration Utility Setup

2.1.1 Installation of the Utility

Please verify that no other Powerline Management Utilities are installed before installing this product. If other utilities are installed, uninstall them and restart before installing this software.

To install, insert the Windows OS Configuration Utility Setup utility CD-ROM into the computer's CD-ROM drive. The Setup utility shall run automatically. Choose the correct one utility to install or user can manually install by double clicking the setup.exe file when browse the folder. The CD will launch an installation utility similar to the one shown in *Figure 1*.

This Utility is designed for Powerline 85M/200M Ethernet bridges. Click the **Next** button to continue.

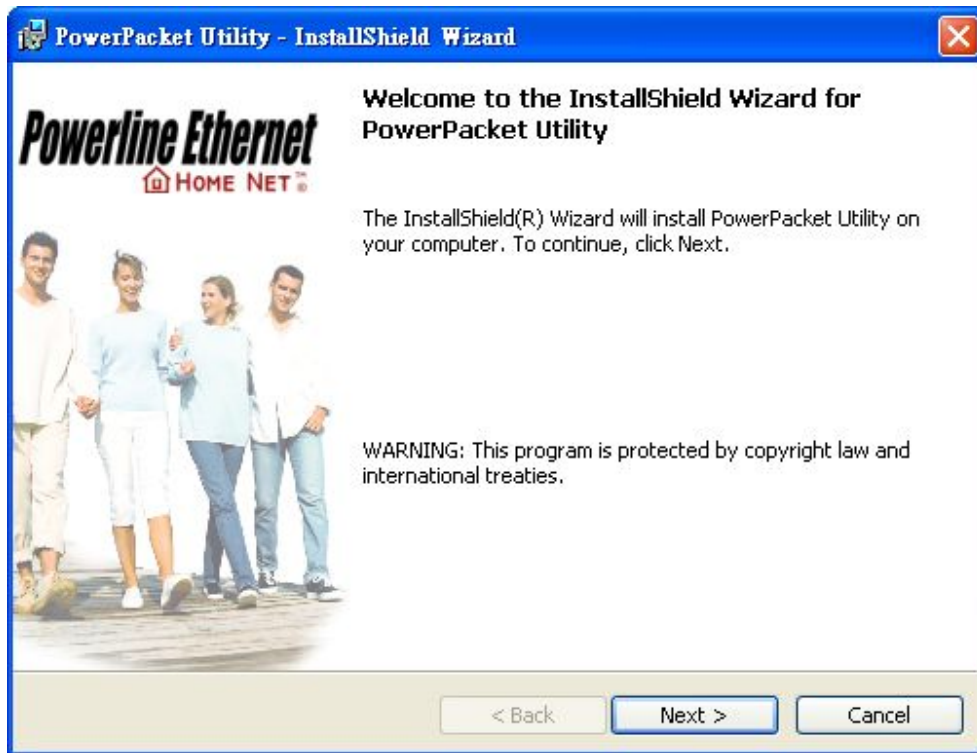

Figure 1: Install Shield Screen

2.2 Windows Configuration Utility

In order to run the utility, double-click the utility icon. *Figure 2* shows the main screen of the configuration utility. This screen shot shows a Powerline Ethernet device connected as a local device and other Powerline Ethernet devices as remote devices.

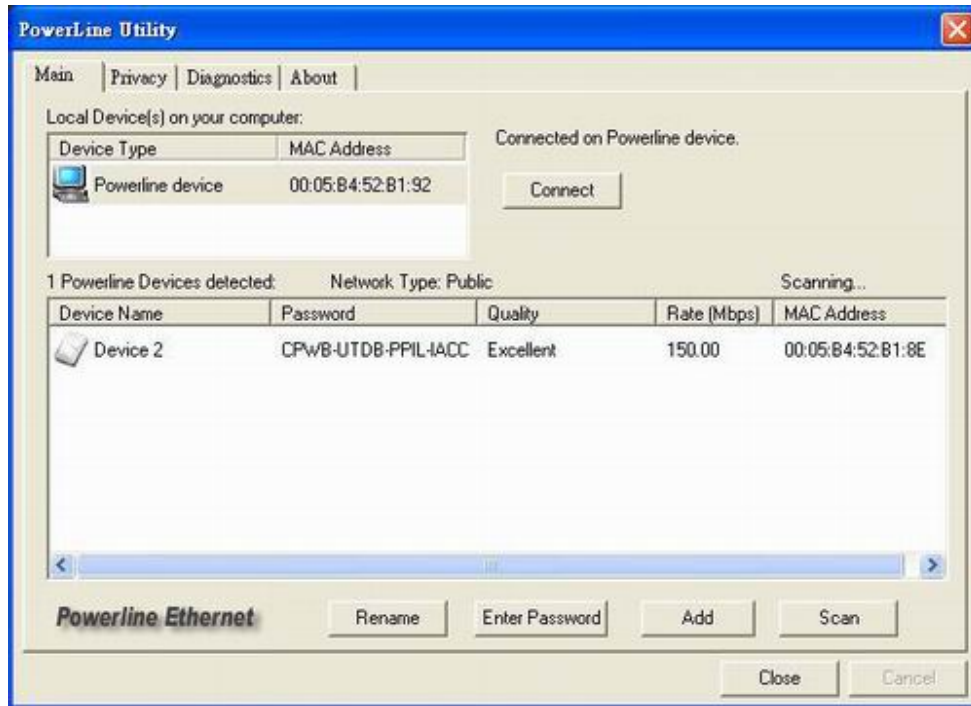

Figure 2: Main Screen with High-Speed Powerline Ethernet device Local

2.3 User Interface

2.3.1 Main Screen

The **Main** screen essentially provides a list of all Powerline Ethernet devices logically connected to the computer where the utility is running.

The top panel shows all local Powerline Ethernet devices found connected to the computer's NIC (Network Interface Card). In most cases, only one device will be seen. In situations where there are more than one device connected, such as a USB and also an Ethernet device, the user may click to select the one to manage through and then click the **Connect** button to its right. The status area above the button indicates that your PC is connected to that same device. Once connected to the chosen local device, the utility will automatically scan the powerline periodically for any other Powerline Ethernet devices. If no local Powerline Ethernet devices are discovered, the status area above the connect button will indicate that accordingly.

Figure 3 illustrates the presence of two local devices in the computer.

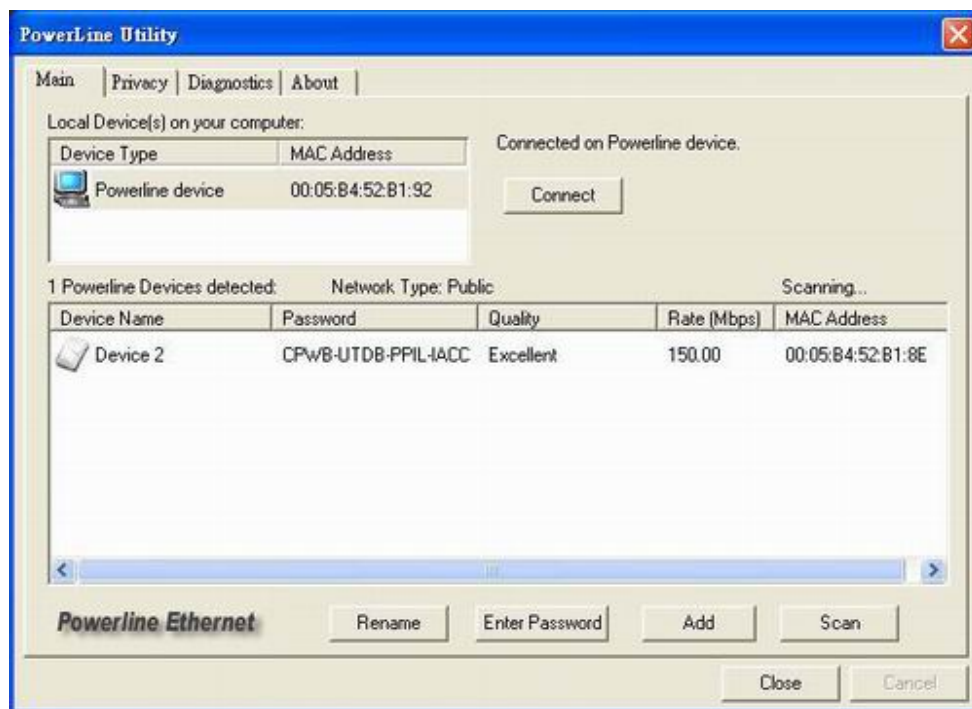

Figure 3: Multiple Local Device Connection

The **lower panel** displays all the Powerline Ethernet devices, discovered on the current logical network (remote devices). Displayed immediately above this panel is the number of remote devices found, the type of logical network (Public or Private), and a message area that reports connectivity and scan status. The following information is displayed for each of the devices discovered that appear in the lower panel:

Device Name column shows the default device name, which may be user re-defined. A user may change the name by clicking on the name and editing in-place, or by using the rename button. An icon is optionally shown with the name. A distinction in icons is made between low-speed and high-speed devices . By default, the icon is displayed with the name.

MAC Address column shows the device's MAC address.

Password column shows the user-supplied device password (initially left blank).

A user may enter the password by using the Enter Password button.

To set the **Password** of the device (required when creating a private network), first select the device by clicking on its name in the lower panel and then click on the Enter Password button.

A dialog box will appear as shown in Figure 4 to type the password. The selected device name is shown above the field for entering the password. Hit OK after entering the new password. A confirmation box will appear if the password was entered correctly.

If a device is not found, the user will be notified and suggestions to resolve common problems will be presented.



Figure 4: Set Device Password

The **Add** button is used to add a remote device to your network that is not on the displayed list in the lower panel, for example, a device currently on another logical network. Users are advised to locate the passwords for all devices they wish to manage and add them to the local logical network by clicking on the Add button.

A dialog box will appear as seen below. The dialog box allows the user to enter both a device name and the password.

A confirmation box will appear if the password was entered correctly and if the device was found.

If a device is not found, the user will be notified and suggestions to resolve common problems will be presented.



Figure 5: Add Remote Device

Note: The device must be present on the power line (plugged in) in order for the password to be confirmed and added to the network. If the device could not be located, a warning message will be shown.

The **Scan** button is used to perform an immediate search of the Powerline Ethernet devices connected to the computer.

By default the utility automatically scans every few seconds and updates the display.

A typical screen after naming and supplying passwords might appear as in *Figure 6*.

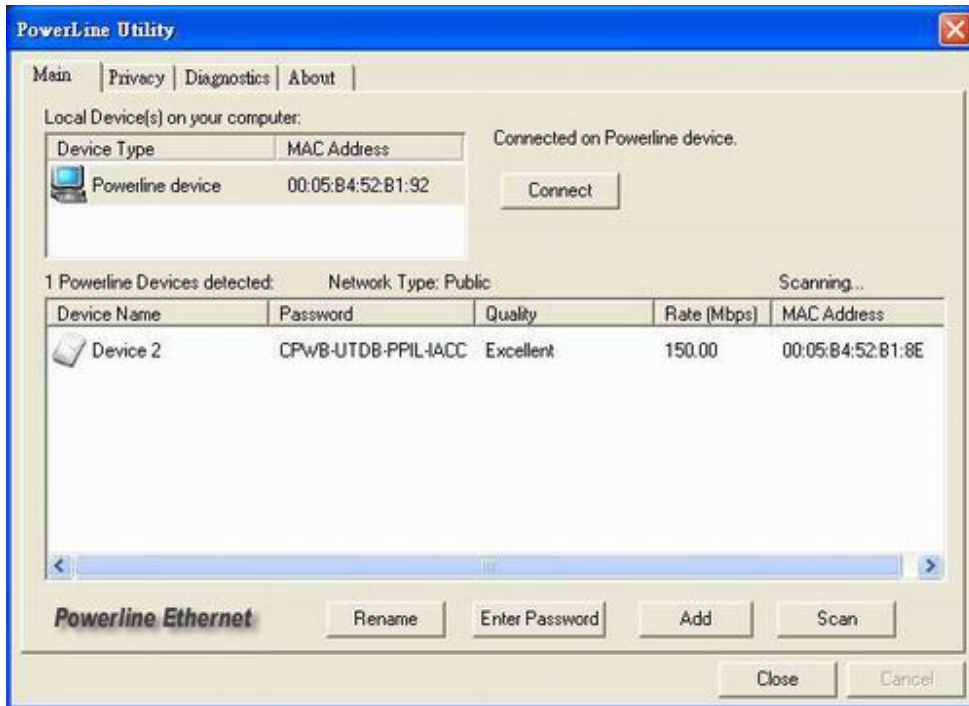

Figure 6: Main Screen of the Configuration Utility

2.3.2 Privacy Screen

The Privacy dialog screen provides a means for managing the local network and providing additional security. All Powerline Ethernet devices are shipped using a default logical network (network name), which is normally “HomePlug”.

The **Privacy** dialog screen allows user to make the network private by changing the network name (network password) of devices.

The user can always reset a Powerline Ethernet network to the universal one (public) by entering “HomePlug” as the network name or by clicking on the **Use Default** button.

Note: Changing the network name to any other name other than HomePlug will show the network type on the main screen as Private.

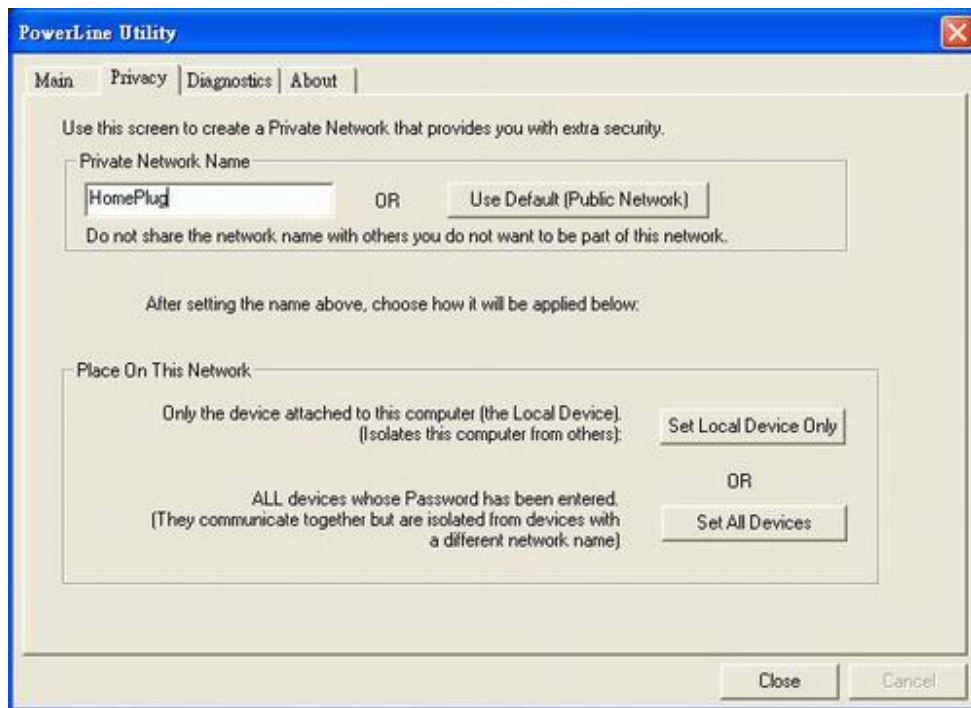

Figure 7: Privacy Screen

The **Set Local Device Only** button is used to change the network name (network password) for the local device only.

After doing this, all the devices seen on the Main panel prior to this will no longer be able to communicate or respond to the computer, as they will be on a different logical network. Devices previously set up with the same logical network (same network name) will appear in the device list afterward selecting this option.

The **Set All Devices** button is used to change the logical network of all devices that appear on the Main panel. The user must have entered the device's Password in order to set it to the new logical network. A notification message will appear to report the success of this operation.

2.4 Diagnostics Screen

The **Diagnostics** screen shows system information and a history of all devices seen.

The appearance is shown in *Figure 8*.

The **upper panel** shows technical data concerning software and hardware on the host computer used to communicate over Powerline Ethernet Network.

It shall include the following:

- Operating System Type/Version
- Host Network Name
- User Name
- MAC Address of all NICs (network interface card)
- Identify versions of all Driver DLLs and Libraries used (NDIS) and optionally
- MAC Firmware Version

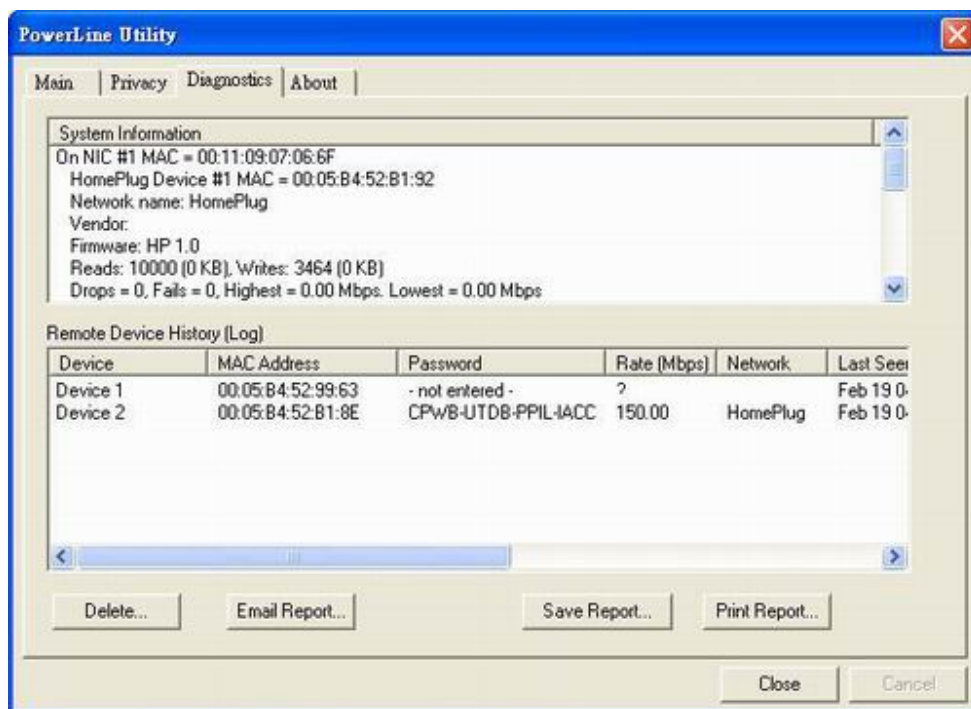

Figure 8: Diagnostics Screen

The **lower panel** contains a history of all remote devices seen on the computer, over time. Devices are shown here regardless of whether or not they are on the same logical network. Devices that are active on the current logical network will show a transfer rate in the Rate column; devices on other networks, or devices that may no longer exist are shown with an “?” in the Rate column.

The following remote device information is available from the diagnostics screen:

- Adapter Alias Name
- Adapter MAC Address
- Adapter Password
- Adapter Last known rate
- Adapter Last Known Network
- Date device last scanned
- MAC Firmware Version

The diagnostics information displayed may be saved to a text file for later emailing to technical support of a manufacturer or printed for reference during a technical support call. Devices no longer part of the network can be deleted using the delete button.

2.4.1 About Screen

The screen shows the software release date.



Figure 9: About dialog screen

2.4.2 Preferences

The lower part of the panel may display options for user preferences (such as turning the auto-scan feature on or off) as shown *Figure 9* above.

3. Push Button Setting

There are 2 buttons in this device, one is On/Off switch the other is Reset/Secure Button.

For Reset/Secure Button : Press > 15 seconds for reset to the factory default settings.

For Secure function, here is the description.

Press 2 seconds for auto secure.

Press > 10 seconds for generate a new random encryption key.

Secure button can auto secure and group the Powerline devices, the follow is the scenario for secure button.

Three possible scenarios

Unassociated device joining an existing AVLN

- Two Unassociated devices joining to form a new AVLN
 - Special case: one device is a CCo, the other is a STA
- Two Associated devices joining to form an AVLN with a new NMK

Possible Use Case Scenario 1: Unassociated device joining existing AVLN

- ◆ STA C wants to join AVLN AB
- ◆ STA A (or B) presses PB < 3 sec
- ◆ STA C presses PB < 3 sec (may precede or follow STA A/B PB)
- ◆ STA A (or B) becomes “Adder”
- ◆ STA C becomes “Joiner”
- ◆ AVLN ABC is formed using NMK of AVLN AB

◆ Existing AVLN with a new Unassociated device added

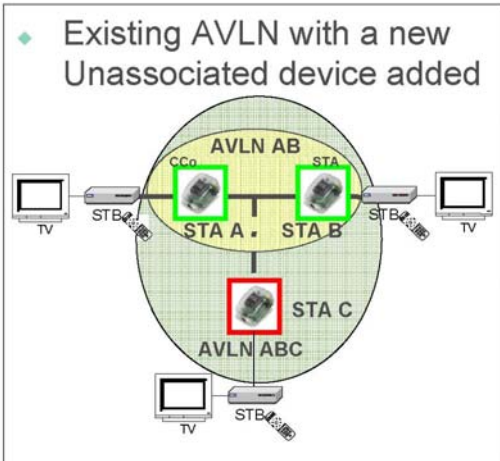

◆  **Unassociated NMK Device**

◆  **Associated NMK Device**

Assumptions:

- 1) An Associated network consists of at least two Associated devices
- 2) All devices are delivered in matched groupings (preloaded NMK)
- 3) Customer-provided device's NMK is different from Associated NMK

Possible Use Case Scenario 2: Two devices joining to form new AVLN

Before this scenario begin, please make sure to press each device secure button > 10 sec till all LEDs re-flash to generate the random network password key first.

- ◆ STA B wants to join with STA A (CCo with pre-existing NMK or a device with higher MAC address)
- ◆ STA A (or B) presses PB < 3 sec
- ◆ STA B presses PB < 3 sec (may precede or follow STA A PB)
- ◆ STA A (CCo or higher MAC value STA) becomes “Adder”
- ◆ STA B becomes “Joiner”
- ◆ AVLN AB is formed using NMK of STA A

◆ Two Unassociated devices forming a new AVLN

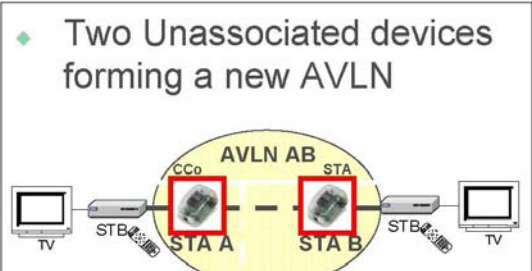

MAC address of STA A > MAC address of STA B
or STA A is CCo of former AVLN and STA B is not

◆  **Unassociated NMK Device**

Assumptions:

- 1) At least one device has a pre-existing [original] NMK (CCo)
- 2) All devices are delivered in matched groupings (preloaded NMK)
- 3) Customer-provided device's NMK is different from original NMK

Possible Use Case Scenario 3: Reset

- ◆ STA C wants to join AVLN AB
- ◆ STA C presses PB > 10 sec to reset its NMK to random value
- ◆ AVLN CD is removed; Case 1 scenario exists and implemented
- ◆ STA A (or B) becomes “Adder” (after PB depressed < 3 sec)
- ◆ STA C becomes “Joiner” (after PB depressed < 3 sec)
- ◆ AVLN ABC is formed using NMK of AVLN AB

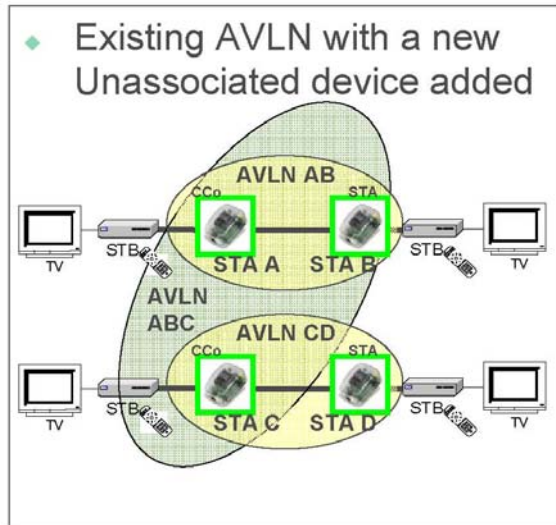

Assumptions:

- 1) An Associated network consists of at least two Associated devices
- 2) All devices are delivered in matched groupings (preloaded NMK)
- 3) Two distinct and different NMK's exist for AVLN



4. Trouble Shooting

1. Why my utility can not work properly after finish install steps?

Ans:

Please follow the steps to check the problem.

1. Check the Windows version, the utility only can support windows 2000, XP, 2003, vista 32, Vista 64.
2. Reinstall the utility again, you can remove it and reinstall the utility again.
3. If the OS is vista 64, make sure you install the correct utility for vista 64. You can see it in CD auto run utility page.

2. What kind of windows OS can install the Powerline utility?

Ans:

Now the Powerline utility only supports Windows 2000, XP and 2003, Vista 32/64.

3. Why the throughput of Powerline 200M bridge is bad?

Ans:

Please follow the steps to check the problem.

1. Due to the master/slave structure, you need to avoid plugging two Powerline bridge in the same time, so you had better plug the Powerline to the power outlet sequence.
2. Please unplug the Powerline bridge and plug again, please remember plug them in sequence. Check the Powerline utility and check the throughput again.

4. Why the Powerine 200M device can not work stable?

Ans:

In some respects, User had better to adjust the NB/PC NIC's connection type setting to 100MBaseTx half duplex while connect to powerline 200M device. It will keep the performance to the best status and stable. When user found the link is unstable or not good, please change the NIC's connection type setting to half duplex.