

WB-H811



1Ch Video Encoder/Server



WARNINGS

TO REDUCE THE RISK OF FIRE OR ELECTRIC SHOCK, DO NOT EXPOSE THIS PRODUCT TO RAIN OR MISTURE.
DO NOT INSERT ANY METALLIC OBJECT THROUGH VENTILATION GRILLS.

CAUTION

	CAUTION RISK OF ELECTRIC SHOCK DO NOT OPEN	
CAUTION : TO REDUCE THE RISK OF ELECTRIC SHOCK. DO NOT REMOVE COVER (OR BACK). NO USER-SERVICEABLE PARTS INSIDE. REFER SERVICING TO QUALIFIED SERVICE PERSONNEL.		

COPYRIGHT

THE TRADEMARKS MENTIONED IN THE MANUAL ARE LEGALLY REGISTERED TO THEIR RESPECTIVE COMPANIES.

Content

I. PREFACE	4
II. PRODUCT SPECIFICATIONS	4
III. PRODUCT INSTALLATION	7
A. MONITOR SETTING	7
B. HARDWARE INSTALLATION.....	8
C. IP ASSIGNMENT	10
D. INSTALL ACTIVE X CONTROL:	13
IV. LIVE VIDEO	15
V. VIDEO SERVER CONFIGURATION	18
A. SYSTEM	19
B. NETWORK	25
C. A/V SETTING	31
D. EVENT LIST	37
VI. NETWORK CONFIGURATION	42
VII. FACTORY DEFAULT	44
VIII. PACKAGE CONTENTS	44
APPENDIX I	44

V1.0_2009/08/31

I. Preface

Video Server is a 1 channel video server with the web server built in. User views real-time video via IE browser. Video Server supports H.264/ MPEG-4 (3GPP Only)/ JPEG video compression which provides smooth and high video quality. The video can be stored in the SD card, and playback remotely. With user friendly interface, it is an easy-to-use video server which can connect any kind of analogue camera to fit the customer's need.

II. Product Specifications

- 1-CH Input
- H.264/ MJPEG/MPEG4 (3GPP only) compression
- SD card backup
- 2-way audio
- Support Cell Phone/PDA/3GPP
- 3 Streaming
- Power Over Ethernet available
- SDK for Software Integration
- Wireless (Optional)
- Free Bundle 36 ch recording software

Specifications

Hardware	
CPU	ARM 9 ,32 bit RISC
DDR2	128MB
Flash	8MB
Video in	1 in BNC connector
Video Looping Input	1
Audio in/ out	1 in/ 1 out
I/O	2 in/ 2 Relay out (COM. & N.O. & N.C.) Relay Out: DC 24V@1A AC 110V@0.5A
RS-485	1, for PTZ control
RS-232	YES

Power Over Ethernet	YES (optional)	
Power Consumption	DC 12V, 350mA, 4W	
Dimensions	134mm (W) x 42mm (L) x 107mm (D)	
Network		
Ethernet	10/ 100 Base-T	
Network Protocol	HTTP, TCP/ IP, SMTP, FTP, PPPoE, DHCP, DDNS, NTP, UPnP, 3GPP	
Wireless (Optional)		
	Wireless	802.11b/g
	Security	WEP,WPA-PSK,WPA2-PSK
System		
Video Resolution	NTSC - 720x480, 704x480,352x240, 176x120 PAL – 720x576, 704x576, 352x288, 176x144	
Image Frame rate	30/25 fps (NTSC/PAL)	
Video adjust	Brightness, Contrast, Saturation, Hue, Sharpness	
Triple Streaming	Yes	
Image snapshot	Yes	
Full screen monitoring	Yes	
Privacy Mask	Yes, 3 different areas	
Compression format	H.264/ JPEG/ MPEG4 (3GPP only)	
Video bitrates adjust	CBR, VBR	
Motion Detection	Yes, 3 different areas	
Triggered action	Mail, FTP, Save to SD card, Relay	
Pre/ Post alarm	Yes, configurable	
Security	Password protection	
Firmware upgrade	HTTP mode, can be upgraded remotely	
Simultaneous connection	Up to 10	
Audio	Yes, 2-way	
SD card management		
Recording trigger	Motion Detection, IP check, Network break down (wire only),schedule, Alarm	
Video format	AVI, JPEG	
Video playback	Yes	

Delete files		Yes
Web browsing requirement		
OS		Windows 2000, XP, 2003, Microsoft IE 6.0 or above
Hardware	Suggested	Intel Dual Core 1.66G, RAM: 1024MB, Graphic card: 128MB
	Minimum	Intel-C 2.8G, RAM: 512MB, Graphic card: 64MB

III. Product Installation

A. Monitor Setting

- i. Right-Click on the desktop. Select “ Properties”



- ii. Change color quality to highest (32bit).

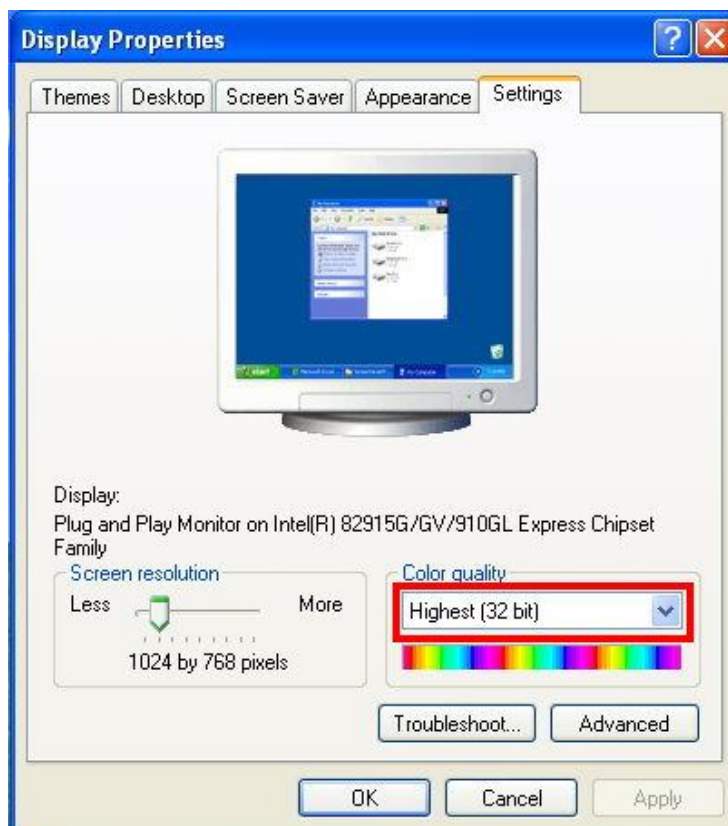

B. Hardware Installation

B-1: Hardware Connection

- i. Connect power adaptor



- ii. Connect Video Server to PC or network with Ethernet cable



- iii. Set up the network configurations according to the network environment. For further explanation, please refer to chapter VI, "Network Configuration for Video Server".

B-2: I/O Control Instruction

I/O terminal connector – used in application, for e.g., motion detection, event triggering, alarm notifications. It provides the interface to:

Digital Input (GND+Alarm) – An alarm input for connecting devices that can toggle between an open and closed circuit, for example: PIRs, door/window contacts, glass break detectors, etc. When a signal is received the state changes and the input becomes active.

Relay output (COM +N.O.) – An output to Relay switch, for example: LEDs, Sirens, etc

Digital Input

Alarm Input

1. GND (Ground) : Initial state is LOW
2. Alarm : Max. 50mA, 12VDC

Relay Output

1. COM: (Common)
2. N.O. (Normally Open): Max. 1A, 24VDC or 0.5A, 125VAC

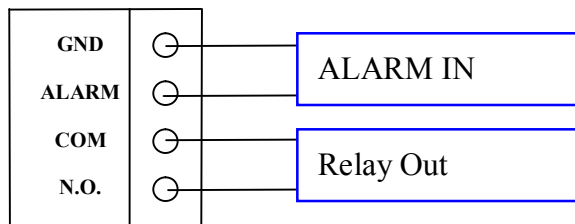

B-2 Relay Connection:

Digital Input connection

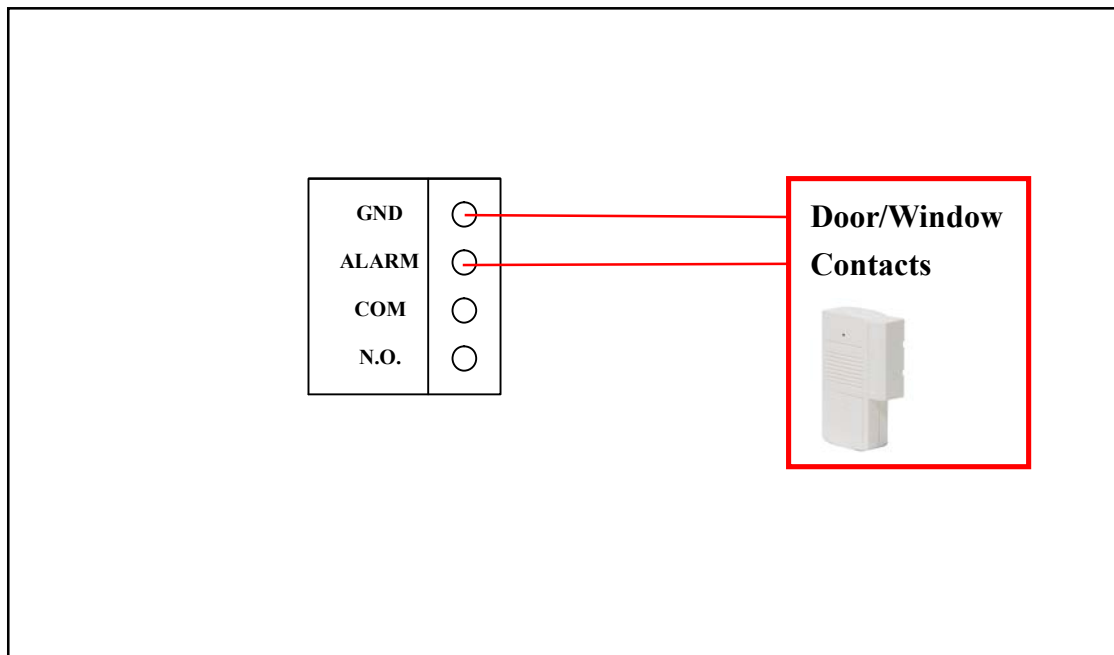

Relay Output Connection

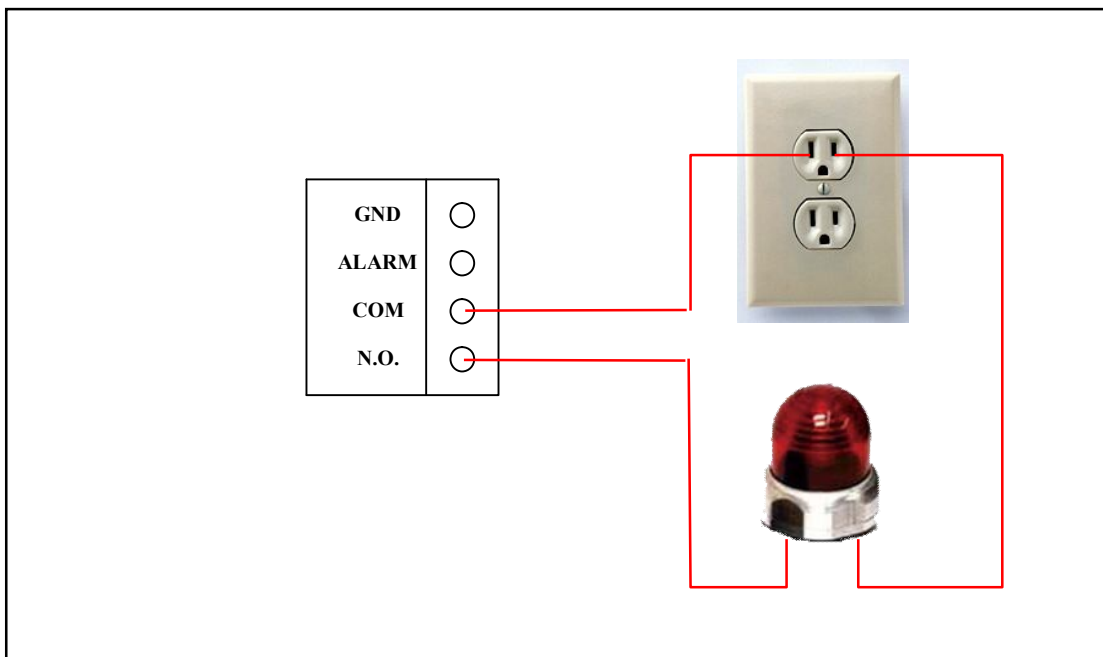

C. IP Assignment

- i. Use the software, "IP Installer" to assign the IP address of Video Server. The software is in the attached software CD.
- ii. There are two languages for the IP installer
 - a. IPInstallerCht.exe : Chinese version
 - b. IPInstallerEng.exe : English version
- iii. There are 3 kinds of IP configuration.
 - a. Fixed IP (Public IP or Virtual IP)
 - b. DHCP (Dynamic IP)
 - c. Dial-up (PPPoE)
- iv. Execute IP Installer
- v. For Windows XP SP2 user, it may popup the following message box. Please click "Unblock".



vi. IP Installer configuration :

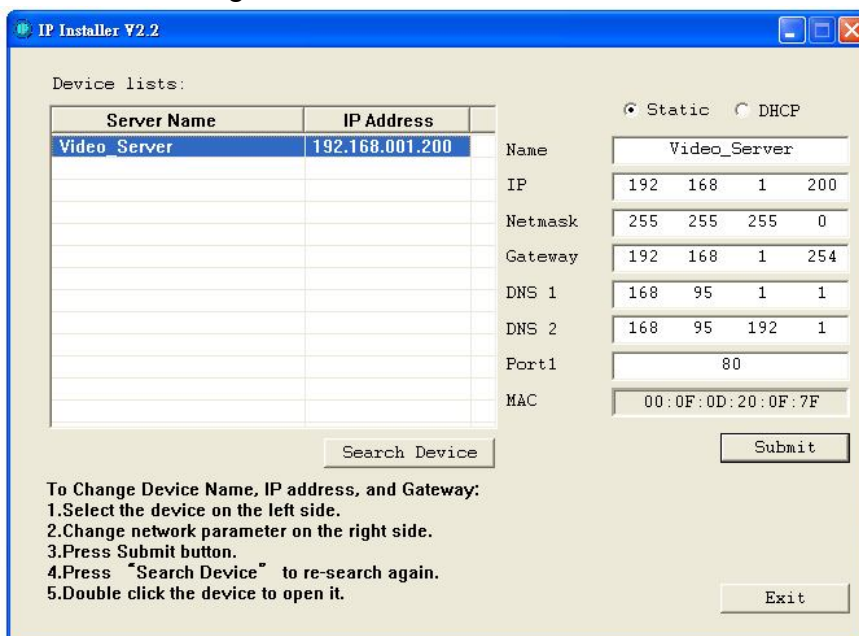

- vii. IP Installer will search all IP Devices connected on Lan. The user can click “Search Device” to search again.
- viii. Click the Video Server listed on the left side. The network configuration of this Video Server will show on the right side. You may change the “name” of the Video Server to your preference (eg: Office, warehouse). Change the parameter and click “Submit” then click “OK”. It will apply the change and reboot the Device.



ix. Please make sure the subnet of PC IP address and Video Server IP address are the same.

The same Subnet:

Video Server IP address: 192.168.1.210

PC IP address: 192.168.1.110

Different Subnets:

Video Server IP address: 192.168.2.210

PC IP address: 192.168.1.110

To Change PC IP address:

Control Panel → Network Connections → Local Area Connection Properties → Internet Protocol (TCP/IP) → Properties

Please make sure your Video Server and PC have the same Subnet. If not, please change Video Server subnet or PC IP subnet accordingly.

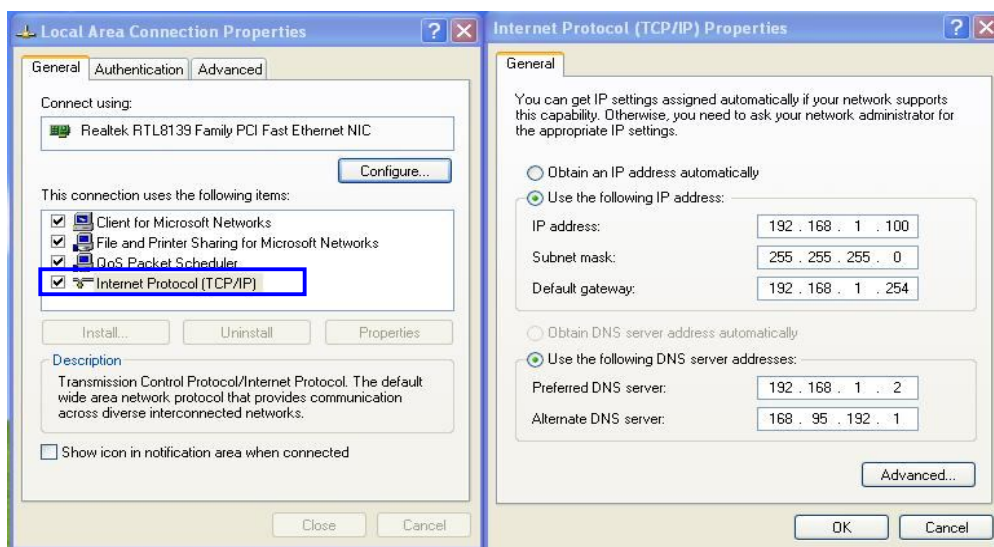

- x. A quick way to access remote monitoring is to left-click the mouse twice on a selected Video Server listed on “Device list” of IP Installer. An IE browser will be opened.

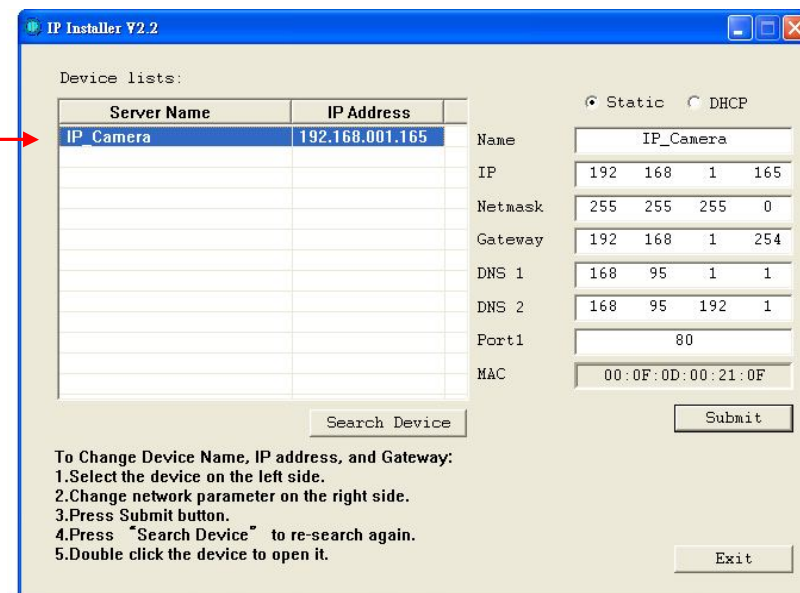

- xi. Then, please key in the default “user name: admin” and “password: admin”.



D. Install ActiveX control:

For the first time to view the video via IE, it will ask you to install the ActiveX component.



If the installation failed, please check the security setting for the IE browser.

- i. IE → Tools → Internet Options... → Security Tab → Custom Level... → Security Settings → Download unsigned ActiveX controls → Select “Enable” or Prompt.
- ii. IE → Tools → Internet Options... → Security Tab → Custom Level... → Initialize and script ActiveX controls not marked as safe → Select “Enable” or Prompt.

1



2

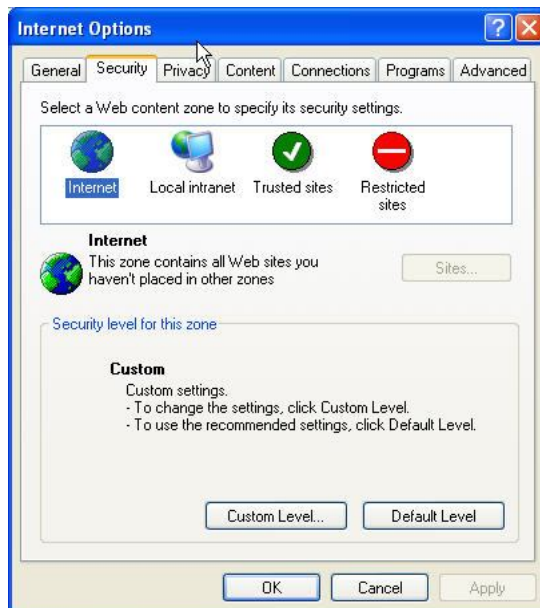

3



4

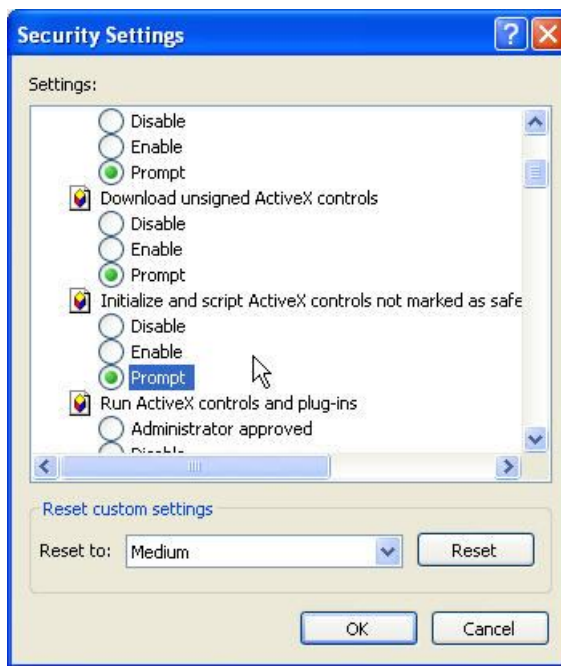

5

When popup the following dialogue box, click "Yes".

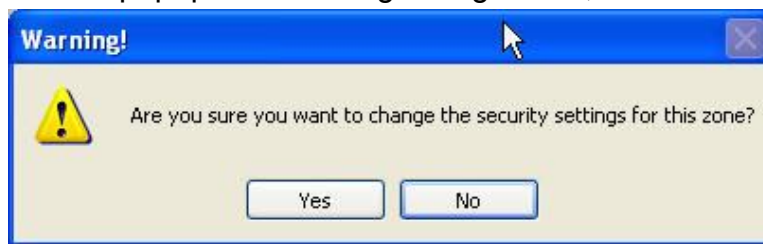



IV. Live Video

Start a IE browser, type the IP address of the Video Server in the address field. It will show the following dialogue box. Key-in the user name and password. The default user name and password are “**admin**” and “**admin**”.

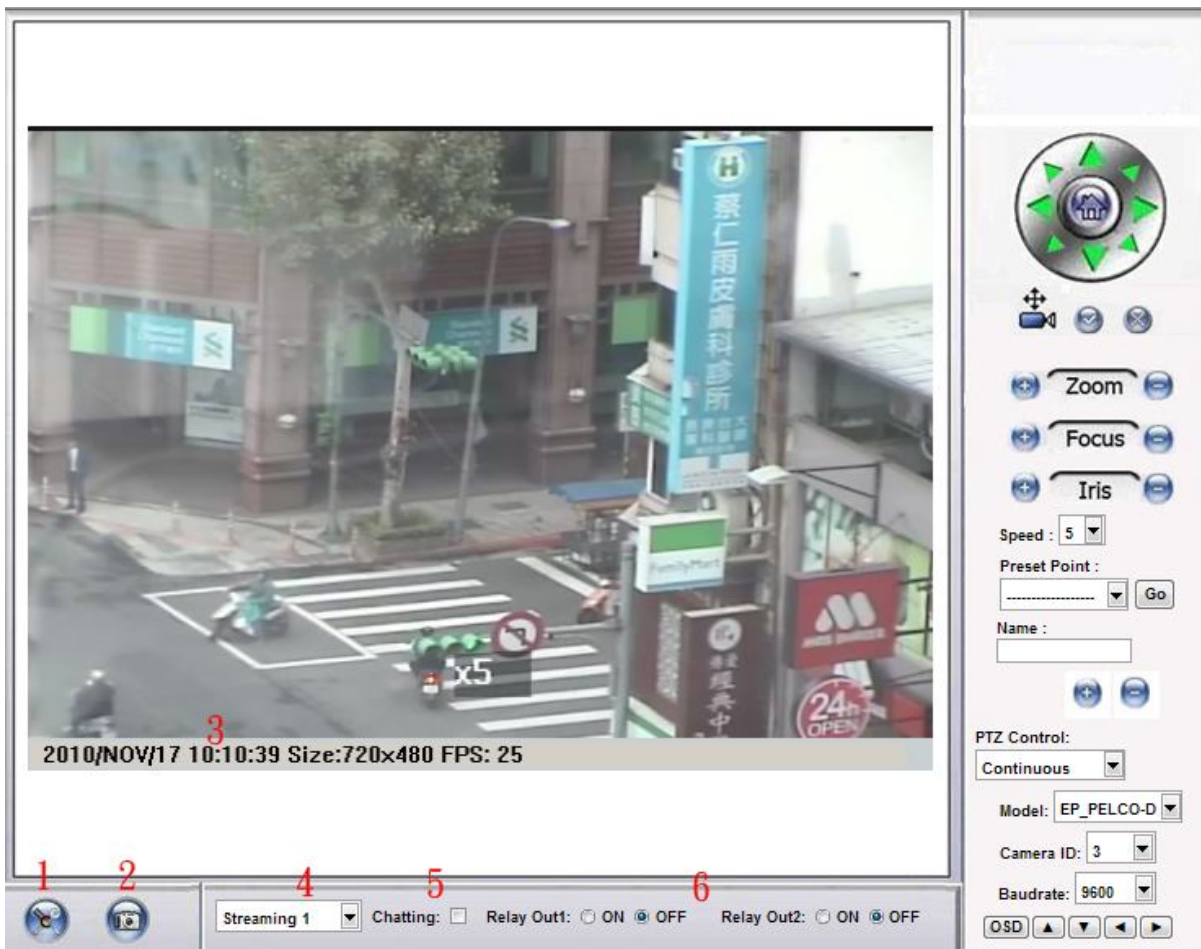

When connect to the Video Server ◦ The following program interface shows.



1.  : Get into the administration page
2.  : Video Snapshot
3. Shows how many people connect to this Video Server
4. Show system time, video resolution, and video refreshing rate
5. Video Server supports 2-way audio. Click the “Chatting” check box. Then you can use microphone which connect to the PC to talk to server side, which is Video Server side.
6. Select PTZ protocol to control the PTZ camera which is connected to this video server. The PTZ function will be slightly different depends on which protocol to use.

Double-click the video, it will change to full screen mode. Press “Esc” or double-click the video again, it will change back to normal mode.

Right-Click the mouse on the video, it will show a pop-up menu.

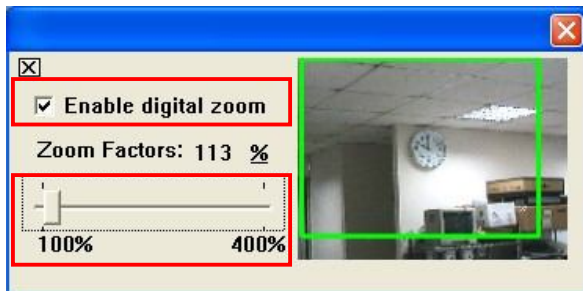

Snapshot
Record Start
Mute
Full Screen
Zoom

1. Snapshot : Save a JPEG picture
2. Record Start : Record the video in the local PC. It will ask you where to save the video. To stop recording, right-click the mouse again. Select “Record Stop”. The video format is AVI. Use Microsoft Media Player to play the recorded file.
3. Mute : Turn of the audio. Click again to turn on it.
4. Full Screen : Full-screen mode.
5. Zoom : Enable zoom-in and zoom-out functions. Select “Enable digital zoom” option first within the pop-up dialogue box and then drag and drop the bar to adjust the zoom factors.



V. Video Server Configuration

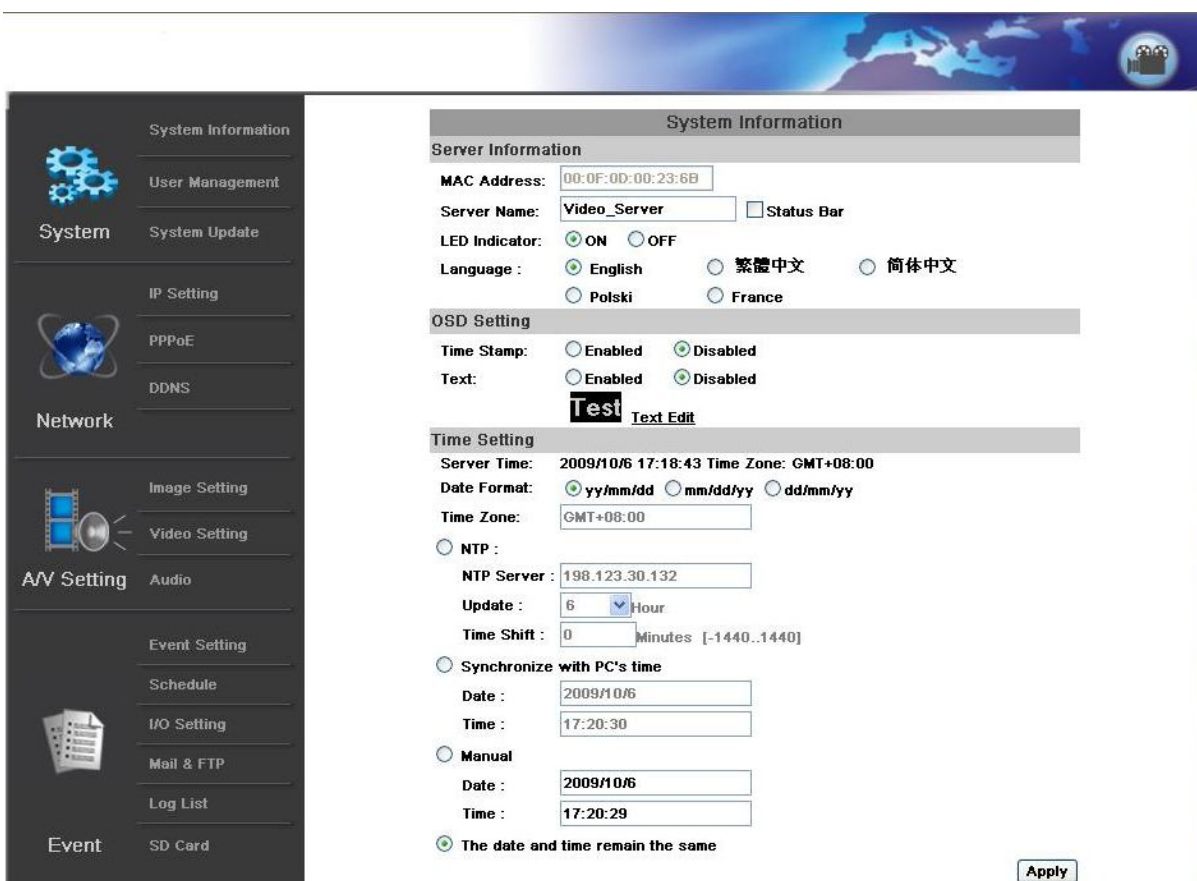

Click  to get into the administration page. Click  to back to the live video page.

The screenshot shows the 'System Information' configuration page. On the left is a navigation menu with categories: System (System Information, User Management, System Update), Network (IP Setting, PPPoE, DDNS), A/V Setting (Image Setting, Video Setting, Audio), and Event (Event Setting, Schedule, I/O Setting, Mail & FTP, Log List, SD Card). The main content area is titled 'System Information' and contains the following sections:

- Server Information:**
 - MAC Address: 00:0F:0D:00:23:6B
 - Server Name: Video_Server Status Bar
 - LED Indicator: ON OFF
 - Language: English 繁體中文 简体中文 Polski France
- OSD Setting:**
 - Time Stamp: Enabled Disabled
 - Text: Enabled Disabled
 - Text content: Test
- Time Setting:**
 - Server Time: 2009/10/6 17:18:43 Time Zone: GMT+08:00
 - Date Format: yy/mm/dd mm/dd/yy dd/mm/yy
 - Time Zone: GMT+08:00
 - NTP:
 - NTP Server: 198.123.30.132
 - Update: 6 Hour
 - Time Shift: 0 Minutes [-1440..1440]
 - Synchronize with PC's time:
 - Date: 2009/10/6
 - Time: 17:20:30
 - Manual:
 - Date: 2009/10/6
 - Time: 17:20:29
 - The date and time remain the same

An 'Apply' button is located at the bottom right of the configuration area.

A. System

i. System Information

a. Server Information : Set up the camera name, select language, and set up the camera time.

1. Server Name : This is the Video Server name. This name will show on the IP Installer.
2. Select Language : There are English, Traditional Chinese, and Simple Chinese to select. When change, it will show the following dialogue box for the confirmation of changing language.



b. Overlay Setting: select a position where date & time showing on screen.



Moreover, click Text Edit can entry to adjust the OSD contents which is including Size and Alpha of text. Finally, click **Upgrade** button to reserve the setting.

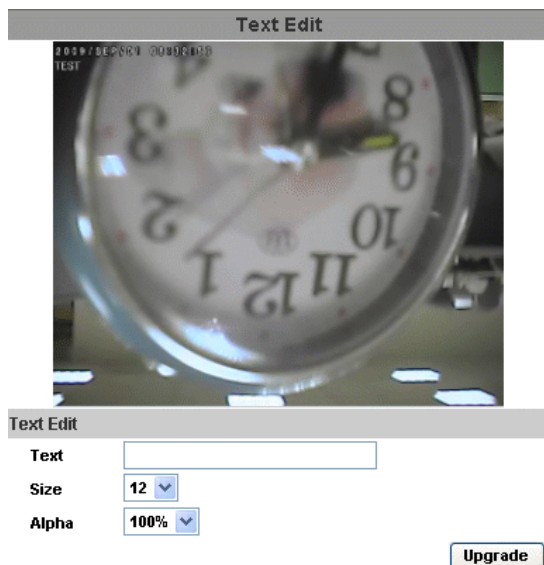

c. Server time setting : Select options to set up time - “NTP”,

“Synchronize with PC’s time”, “Manual”, “The date and time remain the same”.

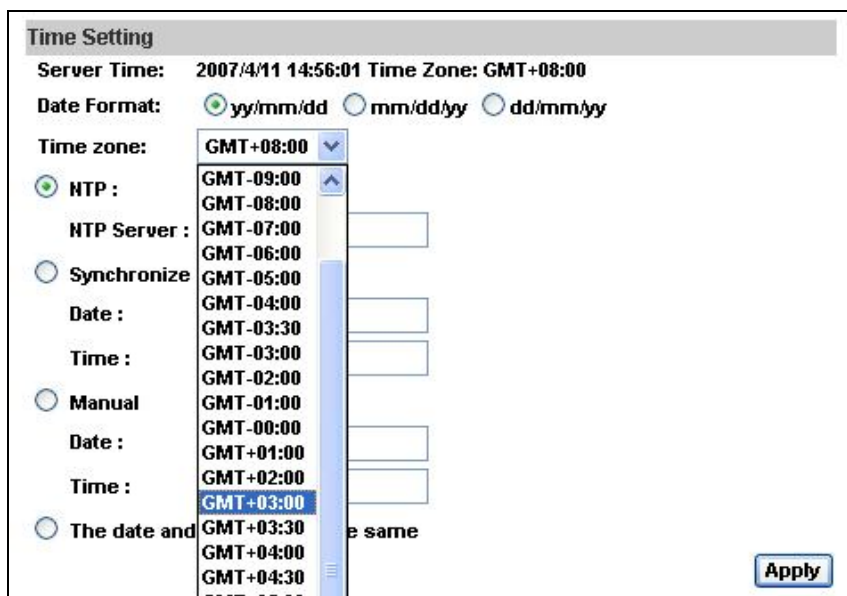

ii \ User Management

Video Server supports three different users, administrator, general user, and anonymous user.

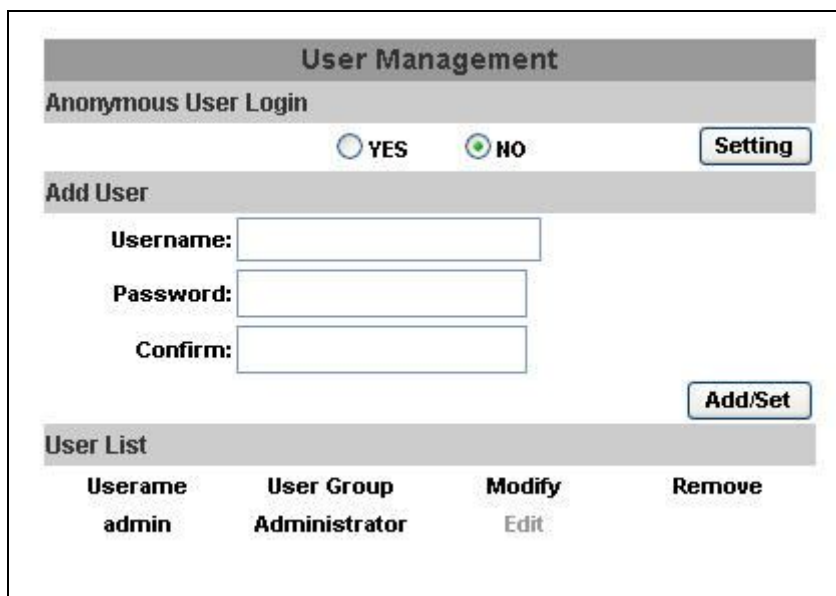

Username	User Group	Modify	Remove
admin	Administrator	Edit	

- a. Anonymous User Login :
 Yes : Allow anonymous login
 No : Need user name & password to access this Video Server
- b. Add user :
 Type the user name and password, then click “Add/Set”.
Note: Allow guest to login as a Guest. Guest is only allowed to browse the page.

- c. Click “edit” or “delete” to modify the user.



The screenshot shows a web browser window with the title "User_Setting - Microsoft Internet Explorer". The main content area is titled "User Setup" and contains the following form elements:

- Username:** A text input field containing the value "admin".
- Password:** An empty text input field.
- Confirm:** An empty text input field.
- OK:** A button located to the right of the "Confirm:" field.

iii 、 System update :

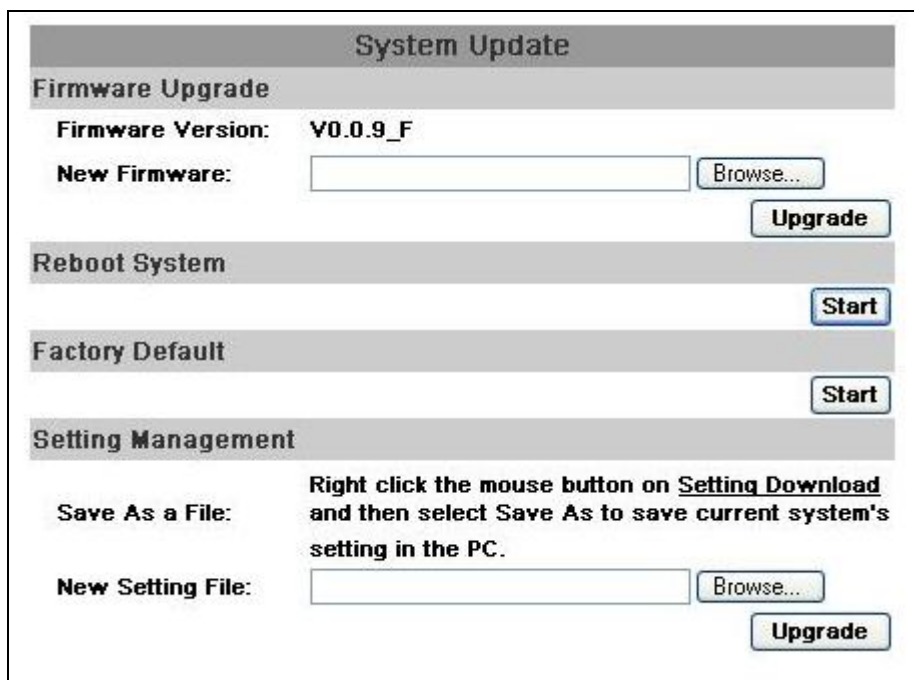

The screenshot shows a web interface titled "System Update". It is divided into several sections:

- Firmware Upgrade:** Shows the current "Firmware Version" as "V0.0.9_F". Below it is a "New Firmware:" field with a "Browse..." button and an "Upgrade" button.
- Reboot System:** A section with a "Start" button.
- Factory Default:** A section with a "Start" button.
- Setting Management:** Contains instructions: "Right click the mouse button on Setting Download and then select Save As to save current system's setting in the PC." Below this is a "New Setting File:" field with a "Browse..." button and an "Upgrade" button.

- a. To update the firmware online, click "Browse..." to select the firmware. Then click "Upgrade" to proceed.
- b. Reboot system : re-start the IP camera
- c. Factory default : delete all settings and restore defaults system.
- d. Setting Management : User may download the current setting to PC, or upgrade from previous saved setting.
 1. Setting download:

Right-click the mouse button on Setting Download → Select "Save AS..." to save current IP CAM setting in PC → Select saving directory → Save
 2. Upgrade from previous setting

Browse → search previous setting → open → upgrade → Setting update confirm → click [index.html](#). to return to main page

iv、PTZ Setting :

a. PTZ control mode : Select by Step by step or Continuous

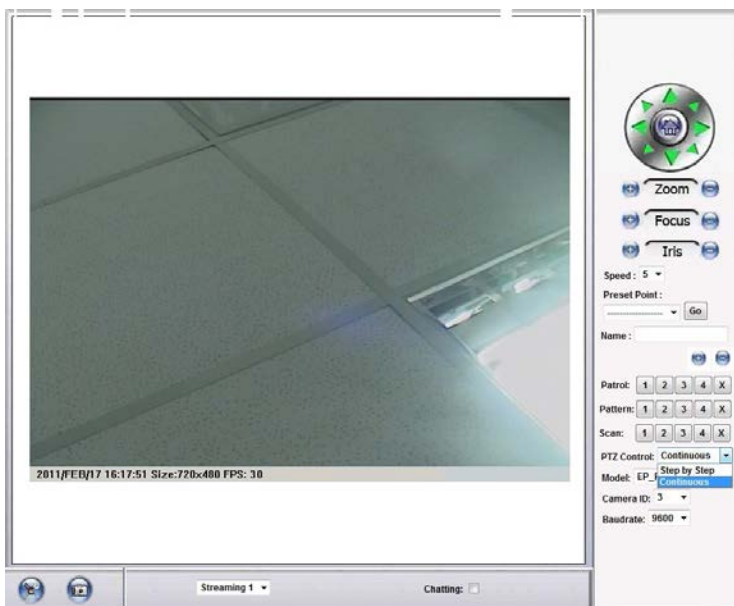

b. Set Patrol

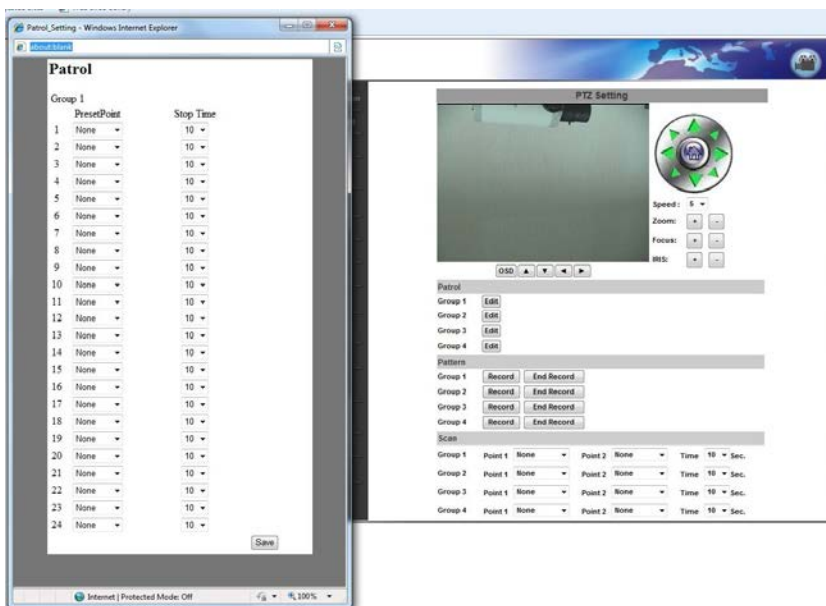

1. Add preset point
2. Edit Patrol group by 24 preset point, then save
3. call Patrol 1 ~ 4 on web page

c. Set Pattern

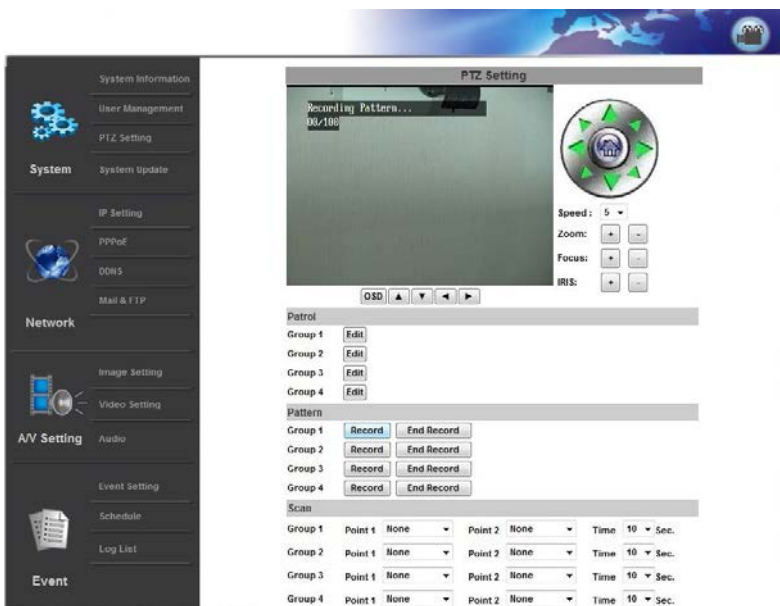

1. Press record button to start record, then press End record to stop record.
2. call Pattern 1 ~ 4 on web page

d. Set Scan

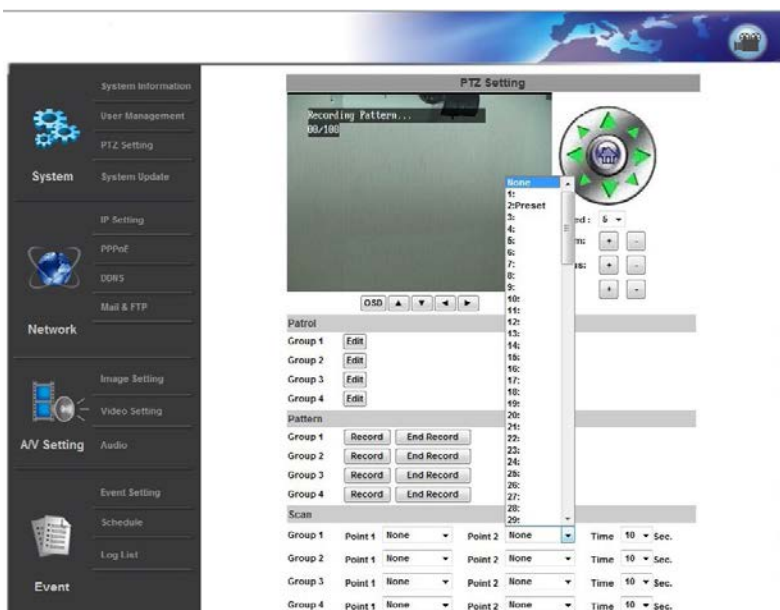

1. Set left / right position by preset point, then set stay time
2. call Scan 1 ~ 4 on web page

B.Network

i. IP Setting

Video Server supports DHCP and static IP.

IP Setting	
IP Assignment	
<input type="radio"/> DHCP	
<input checked="" type="radio"/> Static	
IP Address:	192.168.1.200
Subnet Mask:	255.255.255.0
Gateway:	192.168.1.254
DNS 0:	168.95.1.1
DNS 1:	168.95.192.1
Port Assignment	
Web Page Port:	80
RTSP Port :	554
RTP Start Port:	5000 [1024..10000]
RTP End port:	9000 [1025..10000]
UPnP	
UPnP:	<input checked="" type="radio"/> Enabled <input type="radio"/> Disabled
<input type="button" value="Apply"/>	

- a. DHCP : Using DHCP, IP Vandal Dome will get all the network parameters automatically.
- b. Static IP : Please type in IP address, subnet mask, gateway, and DNS manually.
- c. Port Assignment: user may need to assign different port to avoid conflict when setting up IP assignment.
 - 1. Web Page Port: setup web page connecting port and video transmitting port (Default: 80)
 - 2. RTSP Port: setup port for RTSP transmitting (Default: 554)
 - 3. RTP Start and End Port: in RTSP mode, you may use TCP and UDP for connecting. TCP connection uses RTSP Port (554). UDP connection uses RTP Start and End Port.

d. UPnP

This IP camera supports UPnP, If this service is enabled on your computer, the camera will automatically be detected and a new icon will be added to “My Network Places.”

Note: UPnP must be enabled on your computer.

Please follow the procedure to activate UPnP

1. open the Control Panel from the Start Menu
2. select Add/Remove Programs
3. Select Add/Remove Windows Components and open Networking Services section
4. Click Details and select UPnP to setup the service
5. The IP device icon will be added to “MY Network Places”
6. User may double click the IP device icon to access IE browser

ii 、 PPPoE :

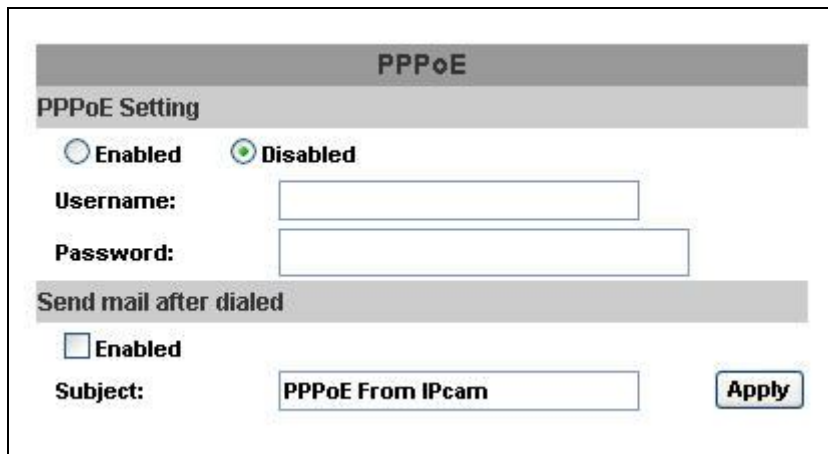

The screenshot shows the 'PPPoE Setting' configuration page. At the top, there is a title bar 'PPPoE' and a sub-header 'PPPoE Setting'. Below this, there are two radio buttons: 'Enabled' (unselected) and 'Disabled' (selected). There are two text input fields: 'Username:' and 'Password:'. Below these is a section titled 'Send mail after dialed' with a checkbox 'Enabled' (unselected) and a 'Subject:' field containing the text 'PPPoE From IPcam'. An 'Apply' button is located at the bottom right of the form.

Select “Enabled” to use PPPoE.

Key-in Username and password for the ADSL connection.

Send mail after dialed : When connect to the internet, it will send a mail to a specific mail account. For the mail setting, please refer to “Mail and FTP” settings.

iii 、 DDNS :

Video Server supports DDNS (Dynamic DNS) service.

a. DynDNS :

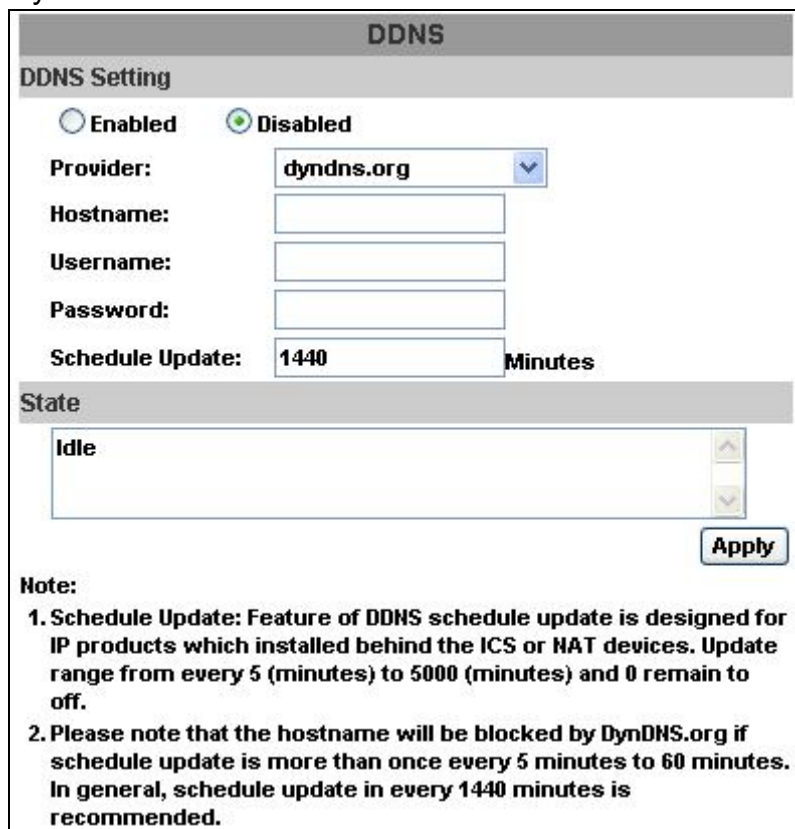

The screenshot shows the 'DDNS Setting' configuration page. At the top, there is a title bar 'DDNS' and a sub-header 'DDNS Setting'. Below this, there are two radio buttons: 'Enabled' (unselected) and 'Disabled' (selected). There are several fields: 'Provider:' with a dropdown menu showing 'dyndns.org', 'Hostname:', 'Username:', 'Password:', and 'Schedule Update:' with a text input '1440' and the label 'Minutes'. Below these is a 'State' section with a dropdown menu showing 'Idle'. An 'Apply' button is located at the bottom right of the form. A 'Note:' section at the bottom contains two numbered items: 1. Schedule Update: Feature of DDNS schedule update is designed for IP products which installed behind the ICS or NAT devices. Update range from every 5 (minutes) to 5000 (minutes) and 0 remain to off. 2. Please note that the hostname will be blocked by DynDNS.org if schedule update is more than once every 5 minutes to 60 minutes. In general, schedule update in every 1440 minutes is recommended.

1. Enable this service
2. Key-in the DynDNS server name, user name, and password.

3. Set up the IP refreshing rate.
 4. Click “Apply”
 5. If setting up IP schedule update too frequently, the IP may be blocked. In general, schedule update every day (1440 minutes) is recommended.
- b. Camddns service :

DDNS

DDNS Setting

Enabled Disabled

Provider: ddns.camddns.com

Username:

Schedule Update: 1440 Minutes

State

Idle

Note:

1. **Schedule Update:** Feature of DDNS schedule update is designed for IP products which installed behind the ICS or NAT devices. Update range from every 5 (minutes) to 5000 (minutes) and 0 remain to off.
2. Please note that the hostname will be blocked by DynDNS.org if schedule update is more than once every 5 minutes to 60 minutes. In general, schedule update in every 1440 minutes is recommended.

1. Please enable this service
 2. Key-in user name
 3. IP Schedule update is default at 5 minutes
 4. Click “Apply”.
- c. DDNS Status
1. Updating : Information update
 2. Idle : Stop service
 3. DDNS registration successful, can now log by <http://<username>.ddns.camddns.com> : Register successfully.
 4. Update Failed, the name is already registered : The user name has already been used. Please change it.
 5. Update Failed, please check your internet connection : Network connection failed.
 6. Update Failed, please check the account information you provide : The server, user name, and password may be wrong.

iv 、 Wireless Setting (Wireless Network Optional)

Supports 802.11 b/g wireless connection.

Notice : Wireless network and Ethernet network use the same IP, the user has to unplug Ethernet cable, if Ethernet cable is not unplug, wireless setting can not be executed.

Wireless Setting			
Status of Wireless Networks			
SSID	Mode	Security	Signal strength
allan	Infrastructure	WPA	79
RHOSON	Infrastructure	WEP	16
Link	Infrastructure	OFF	16
SinoStar	Infrastructure	WEP	11
7f-2	Infrastructure	WEP	12
00160159A7FA	Infrastructure	WEP	56
RDTEST	Infrastructure	WEP	48
3Com	Infrastructure	OFF	43
Default	Infrastructure	WPA	74

Wireless Setting	
MAC Address:	00:16:16:16:DD:E1
Mode:	Infrastructure
Operation Mode:	Auto
SSID:	allan
Security:	None
<input type="button" value="Apply"/>	

- a. Status of Wireless Networks : scan all wireless services.
- b. Wireless Setting :
 1. **Mode** : There are Infrastructure and Ad-hoc. Infrastructure is for connecting with the router. Ad-hoc is for connecting with PC. There is “Channel” to select only when user uses Ad-hoc mode.
e.g. If one PC’s channel is 1, the other’s channel has to 1, too.

Wireless Setting	
MAC Address:	00:11:E2:03:37:48
Mode:	Ad-hoc
Operation Mode:	Auto
SSID:	Default
Channel:	6
Security:	None

2. **SSID** : Based on AP setting.
3. **Channel** : This is only be used when the user selects Ad-hoc mode in order to avoid conflict.
4. **Security** : It supports “None”, “WEP”, “WPA-PSK” security encryption based on the setting of the Router.

5. **WEP :**

Security:	WEP
WEP Setting	
Authentication:	Open System
Encryption:	64 bit
Key Type:	HEX (10 character max)
Key 1:	<input checked="" type="radio"/> <input type="text"/>
Key 2:	<input type="radio"/> <input type="text"/>
Key 3:	<input type="radio"/> <input type="text"/>
Key 4:	<input type="radio"/> <input type="text"/>

- Authentication : There are Open System and Shared Keys, it is based on different encryptions. This has to be the same as the Router’s setting.
- Encryption : There are 64 bits and 128 bits. This is based on Key Type based on the Router’s setting.
- Key Type : There are HEX and ASCII. When selecting HEX, the user only can input 0~9 characters and use A, B, C, D, E, and F.
- When selecting ASCII, the user can input any character.
(Case sensitive)
- Key 1~4 : Based on Key Type to input characters.

6. **WPA-PSK**

Security:	WPA-PSK
WPA-PSK Setting	
Encryption	TKIP
Pre-Shared Key:	<input type="text"/> (ASCII format, 8-63)

- Encryption : There are TKIP and AES.
- Pre-Shared Key : Allow any characters. (Case sensitive)

C.A/V Setting

i \ Image Setting



For the security purpose, there are three areas can be setup for privacy mask. Click Area button first and pull a area on the above image. Finally, click **Save** button to reserve the setting.

Adjust “Brightness”, “Contrast”, “Hue”, “Saturation” to get clear video.

ii \ Video Setting

User may select 3 streaming output simultaneously:

Streaming 1 Setting: Basic mode and Advanced mode

Streaming 2 Setting: Basic mode, Advanced mode

3GPP Streaming Setting

a. Streaming 1 Basic Mode :

Streaming 1 Setting

Basic Mode **Advanced Mode**

Resolution: D1 - 720x480 ▾

Quality: Standard ▾

Video Frame Rate: 30 FPS ▾

Video Format: H.264 ▾

RTSP Path: ex:rtsp://</> **Audio:G.711**

1. Resolution :

There are 4 resolutions to choose.

		NTSC	/	PAL
D1	–	720x480	/	720x576
4CIF	–	704x480	/	704x576
CIF	–	352x240	/	352x288
QCIF	–	176x120	/	176x144

2. Quality :

There are 5 levels to adjust:

Best/ High/ Standard/ Medium/ Low

The higher the quality is, the bigger the file size is.

Also not good for internet transmitting

- 3. Video Frame Rate : The video refreshing rate per second.
- 4. Video Format : H.264 or MJPEG.
- 5. RTSP Path: RTSP output name

b. Streaming 1 Advanced Mode :

Streaming 1 Setting

Basic Mode **Advanced Mode**

Resolution: D1 - 720x480 ▾

Bitrate Control Mode: CBR VBR

Video Quantitative: 7 ▾

Video Bitrate: 1Mbps ▾

Video Frame Rate: 30 FPS ▾

GOP Size: 1 X FPS ▾ GOP = 30

Video Format: H.264 ▾

RTSP Path: ex:rtsp://</> **Audio:G.711**

1. Resolution :

There are 4 resolutions to choose.

		NTSC	/	PAL
--	--	------	---	-----

D1	–	720x480	/	720x576
4CIF	–	704x480	/	704x576
CIF	–	352x240	/	352x288
QCIF	–	176x120	/	176x144

2. Bitrate Control Mode

There are CBR [Constant Bit Rate] and VBR [Variable Bit Rate] to use.

CBR : 32Kbps~4Mbps – Increase CBR to increase the picture quality; vise versa

VBR : 1(Low)~10(High) – Compression rate, the higher the compression rate, the lower the picture quality is; vise versa.

The balance between VBR and network bandwidth will affect picture quality. Please carefully select the VBR rate to avoid picture breaking up or lagging.

3. Video Frame Rate

Picture display frame per second

NTSC: Max 30 frames/second PAL: Max 25 frames/second

4. GOP Size

It means "Group of Pictures". The higher the GOP is, the better the quality is.

5. Video Format :

There are 2 Video Format to choose

H.264 or MJPEG.

6. RTSP Path: RTSP output connecting route

c. Streaming 2 Basic Mode :

Streaming 2 Setting

Basic Mode Advanced Mode

Resolution: CIF - 352x240 ▼

Quality: Standard ▼

Video Frame Rate: 30 FPS ▼

Video Format: H.264 ▼

RTSP Path: v2 **ex:rtsp://</>v2 Audio:G.711**

1. Resolution :

There are 4 resolutions to choose.

NTSC / PAL

D1	–	720x480	/	720x576
----	---	---------	---	---------

- 4CIF – 704x480 / 704x576
- CIF – 352x240 / 352x288
- QCIF – 176x120 / 176x144

2. Quality :

There are 5 levels to adjust:

Best/ High/ Standard/ Medium/ Low

The higher the quality is, the bigger the file size is. Also not good for internet transmitting

3. Video Format : H.264 or JPEG

4. RTSP Path: RTSP output connecting route

d. Streaming 2 Advanced Mode :

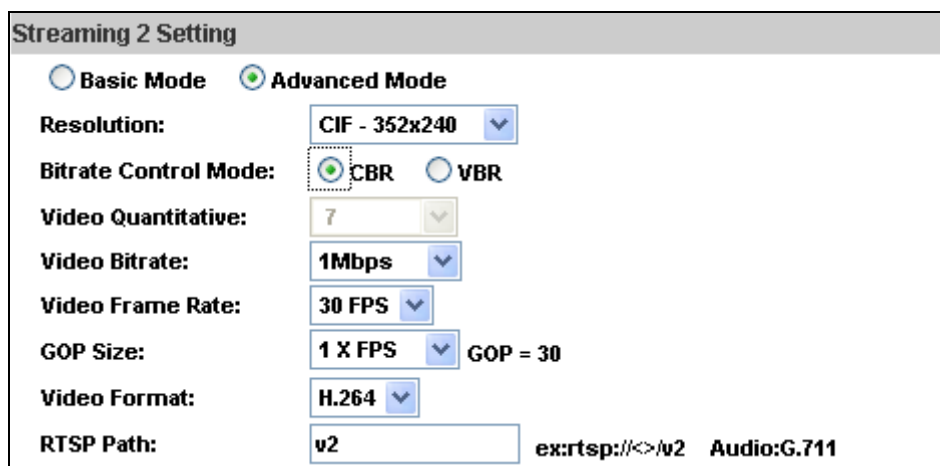

1. Resolution :

There are 4 resolutions to choose.

- NTSC / PAL
- D1 – 720x480 / 720x576
- 4CIF – 704x480 / 704x576
- CIF – 352x240 / 352x288
- QCIF – 176x120 / 176x144

2. Bitrate Control Mode

There are CBR (Constant Bit Rate) and VBR (Variable Bit Rate) to use.

CBR : 32Kbps~4Mbps (the higher the CBR is, the better the video quality is)

VBR : 1~10 (Compression Rate)

3. Video Frame Rate

The video refreshing rate per second.

4. GOP Size

It means "Group of Pictures". The higher the GOP is, the better the quality is.

5. Video Format : H.264 or JPEG
 6. RTSP Path: RTSP output name
- e. 3GPP Streaming Setting mode:

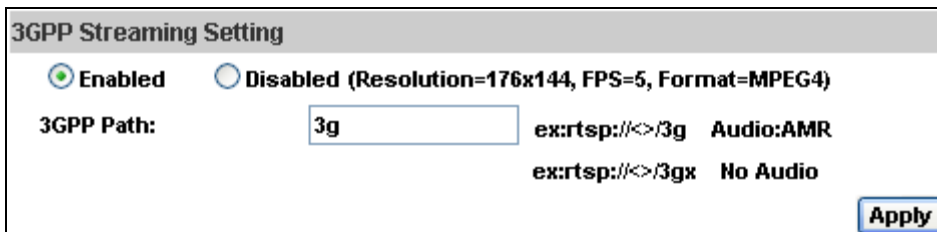

3GPP default value is Resolution=176x144 · 5FPS · Format=MPEG4

1. Enable or Disable 3GPP Streaming
 2. 3GPP: 3GPP output name
- iii · Audio :
- Video Server supports 2-way audio.
- a. From video server to local PC, select "Enable" to start this function (When enabled, you can send audio via external mic in the IP Camera)

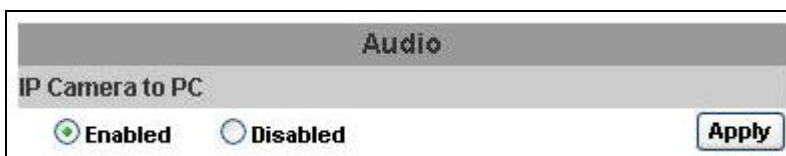

- b. From local PC to Video Server, check “chatting” in the browsing page (You will need a mic to send audio from local PC to IP Camera)

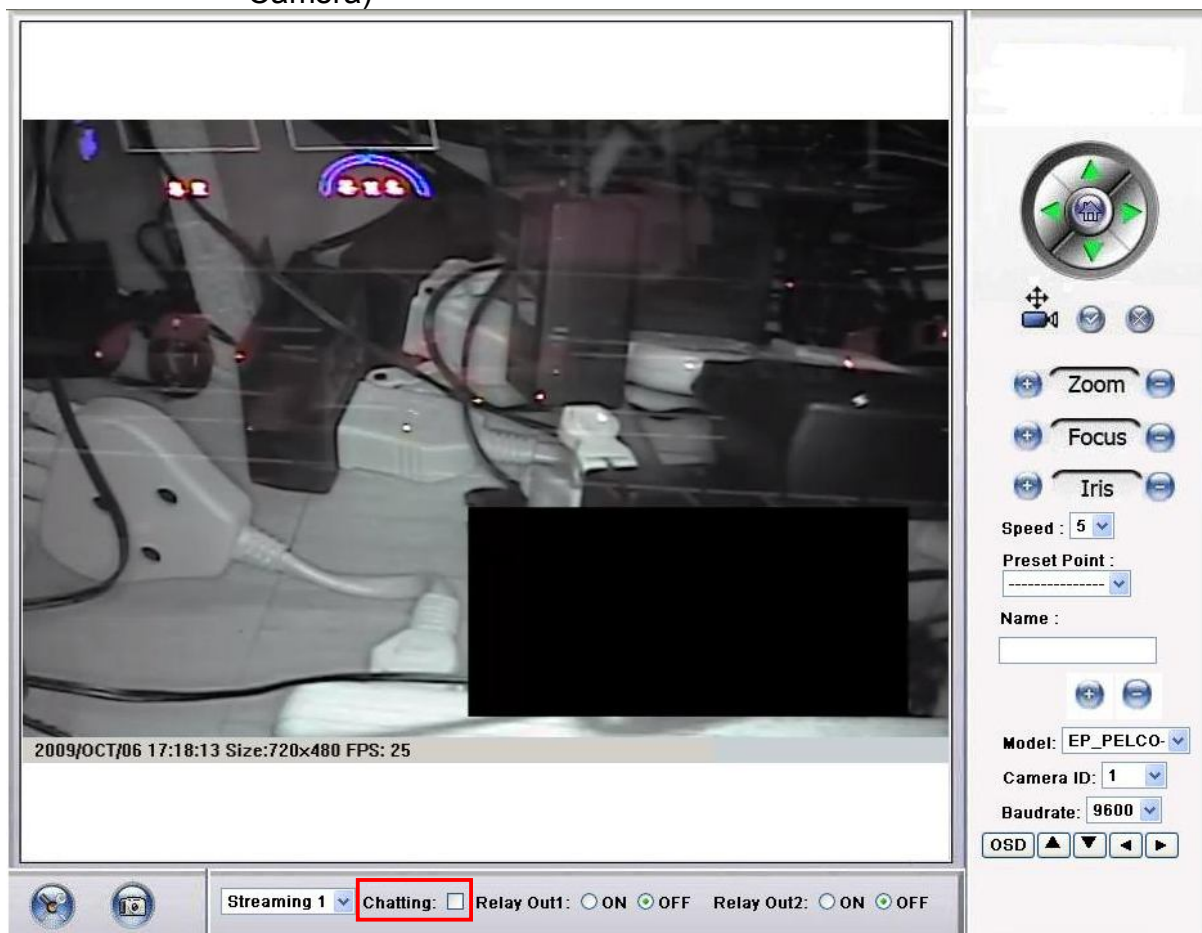

The Audio will not be smooth when enable SD card recording function simultaneously.

D.Event List

Video Server provides multiple event settings.

i、 Event Setting

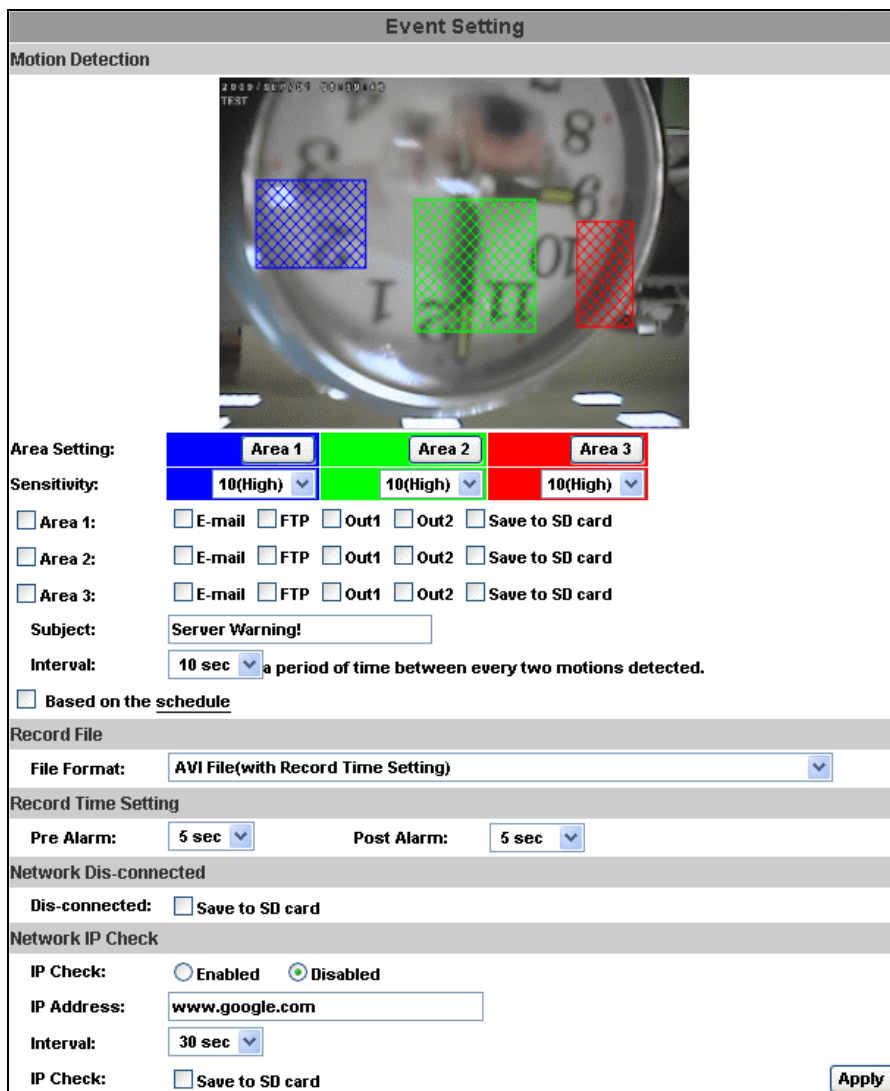

- a. Motion Detection :
Video Server allows 3 areas motion detection. When motion is triggered, it can send the video to some specific mail addresses, transmit the video to remote ftp server, trigger the relay, and save video to local SD card. To set up the motion area, click “Area Setting”. Using mouse to drag and draw the area. The same operation for area 2 and 3.
- b. Record File Setting: IP CAMERA allows 3 different types of recording file to change its record size.
When motion/alarm is triggered, there are 3 different types of

record mode.

1. AVI File (With Record File Setting)
 2. Multi-JPEG (With Record File Setting), only with JPEG compression format.
 3. Single JPEG (Single File with Interval Setting)
- c. Record Time Setting :
- Pre Alarm and Post Alarm setups for video start and end time when motion detected, I/O, or other devices got triggered.
- Note: Pre/Post Alarm record time is base on record time setting and IP Cam built-in Ram memory. Limited by IP Cam built-in Ram Memory, When information is too much or video quality set too high, it will cause recording frame drop or decrease on post alarm recording time.*
- d. Network Dis-connected
- When the network is down, it will save the video to local SD card.
- This function is only enabled in wire connection.**
- e. Network IP check
- When the connection is down, it records the video to SD card. Make sure the video recording is continuous. To use this function, key in the IP address of the PC which has recording software installed. Enable the function of “Save to SD card”, then click “Apply”.
- The interval of two video files on SD card is fixed with 30 seconds.**
- ii 、 Schedule
- a. Schedule: After complete the schedule setup, the camera data will be recorded according to the schedule setup.
 - b. Snapshot: After enable the snapshot function, user can select the storage position of snapshot file, the interval time of snapshot and the reserved file name of snapshot.

Schedule																								
All	0	1	2	3	4	5	6	7	8	9	10	11	12	13	14	15	16	17	18	19	20	21	22	23
Mon.																								
Tue.																								
Wed.																								
Thu.																								
Fri.																								
Sat.																								
Sun.																								

 With schedule setup.

Snapshot	
<input type="radio"/> Enabled	<input checked="" type="radio"/> Disabled
Snapshot:	<input type="checkbox"/> E-mail <input type="checkbox"/> FTP <input type="checkbox"/> Save to SD card
Interval:	<input type="text" value="10"/> Second(s) [1..50000]
File Name:	<input type="text" value="Snapshot"/>

iii 、 I/O Setting

Video Server supports 2 input/ 2 Relay output. When input is triggered, it can send the video to some specific mail addresses, transmit the video to remote ftp server, trigger the relay, and save video to local SD card.

I/O Setting	
Input Setting	
Input 1 Sensor:	<input type="text" value="N.O"/> ▼
Input 1 Action:	<input type="checkbox"/> E-mail <input type="checkbox"/> FTP <input type="checkbox"/> Out1 <input type="checkbox"/> Out2 <input type="checkbox"/> Save to SD card
Input 2 Sensor:	<input type="text" value="N.O"/> ▼
Input 2 Action:	<input type="checkbox"/> E-mail <input type="checkbox"/> FTP <input type="checkbox"/> Out1 <input type="checkbox"/> Out2 <input type="checkbox"/> Save to SD card
Subject:	<input type="text" value="GPIO In Detected!"/>
Interval:	<input type="text" value="10 sec"/> ▼
Output Setting	
Mode Setting:	<input checked="" type="radio"/> OnOff Switch <input type="radio"/> Time Switch
Interval:	<input type="text" value="10 sec"/> ▼

iv 、 Mail & FTP

To send out the video via mail of ftp, please set up the configuration first.

Mail & FTP	
Mail Setting	
Mail Server:	<input type="text"/>
Username:	<input type="text"/>
Password:	<input type="text"/>
Sender's Mail:	<input type="text"/>
Receiver's Mail:	<input type="text"/>
Bcc Mail:	<input type="text"/>
FTP Setting	
FTP Server:	<input type="text"/>
Username:	<input type="text"/>
Password:	<input type="text"/>
Port:	<input type="text" value="21"/>
Path:	<input type="text" value="/"/>
<input type="button" value="Apply"/>	

v \ Log List

Log List	
System Logs	Logs
Motion Detection Logs	Logs
I/O Logs	Logs
All Logs	Logs

Sort by System Logs, Motion Detection Logs and I/O Logs. In addition, System Logs and I/O Logs won't lose data due to power failure.

vi \ SD card

Please Insert SD card before use it. Make sure pushing SD card into the slot completely.

Note : The use of the SD card will affect the operation of the Video Server slightly, such as affecting the frame rate of the



a. Playback :

Playback	
19700101	20060417
SD Card: << 878M / 982M >>	

1. It will show the capacity of the SD card. Click the date listed on this page. It will show the list of the video.

2006/04/17			Del
Time	Video	Event Type	<input type="checkbox"/>
09:05:22	090522f.avi	Network Dis-connected	<input type="checkbox"/>
09:05:52	090552f.avi	Network Dis-connected	<input type="checkbox"/>
09:06:22	090622f.avi	Network Dis-connected	<input type="checkbox"/>
09:06:52	090652f.avi	Network Dis-connected	<input type="checkbox"/>
09:07:22	090722f.avi	Network Dis-connected	<input type="checkbox"/>
09:07:52	090752f.avi	Network Dis-connected	<input type="checkbox"/>
09:08:22	090822f.avi	Network Dis-connected	<input type="checkbox"/>
09:08:51	090851f.avi	Network Dis-connected	<input type="checkbox"/>
09:09:21	090921f.avi	Network Dis-connected	<input type="checkbox"/>
09:09:51	090951f.avi	Network Dis-connected	<input type="checkbox"/>

1 2 3 4 5

2. The video format is AVI. Click the video to start Microsoft Media Player to play it.
3. To delete the video, check it, then click **Del**. When the SD card is full, it will remove the oldest video automatically.

VI. Network Configuration

i. Configuration 1 :

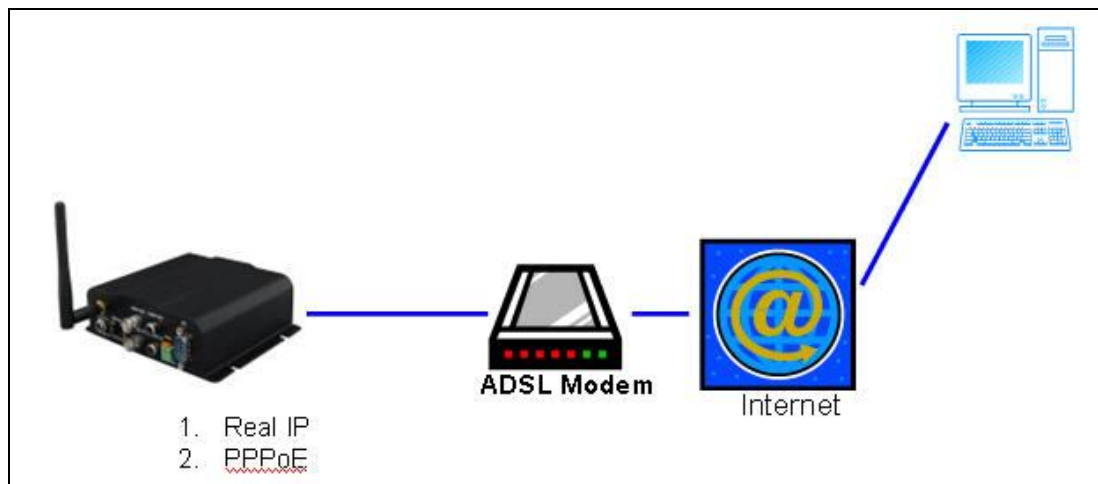

- A. Internet Access : ADSL or Cable Modem
- B. IP address : One real IP or one dynamic IP
- C. Only Video Server connects to the internet
- D. For fixed real IP, set up the IP into Video Server. For dynamic IP, start PPPoE.

ii. Configuration 2 :

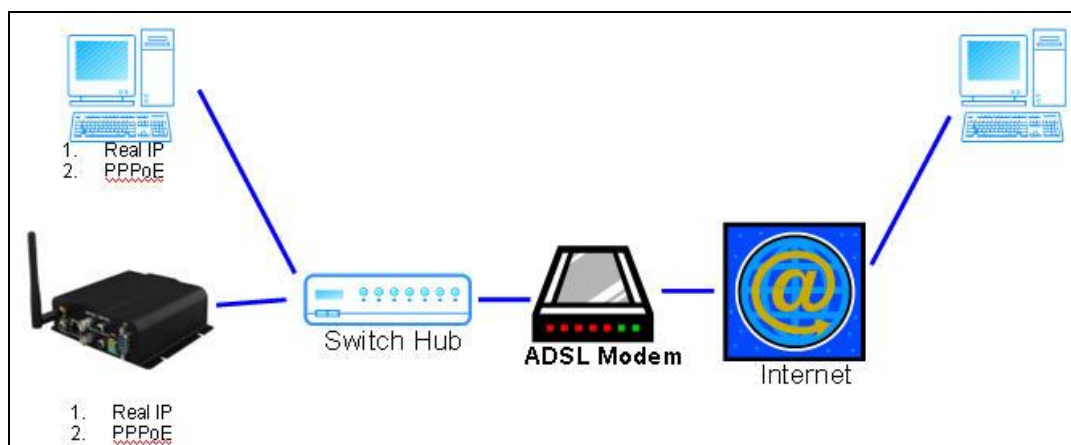

- a. Internet Access : ADSL or Cable Modem
- b. IP address : More than one real IP or one dynamic IP
- c. Video Server and PC connect to the internet
- d. Device needed : Switch Hub
- e. For fixed real IP, set up the IP into Video Server and PC. For dynamic IP, start PPPoE.

iii 、 Configuration 3 :

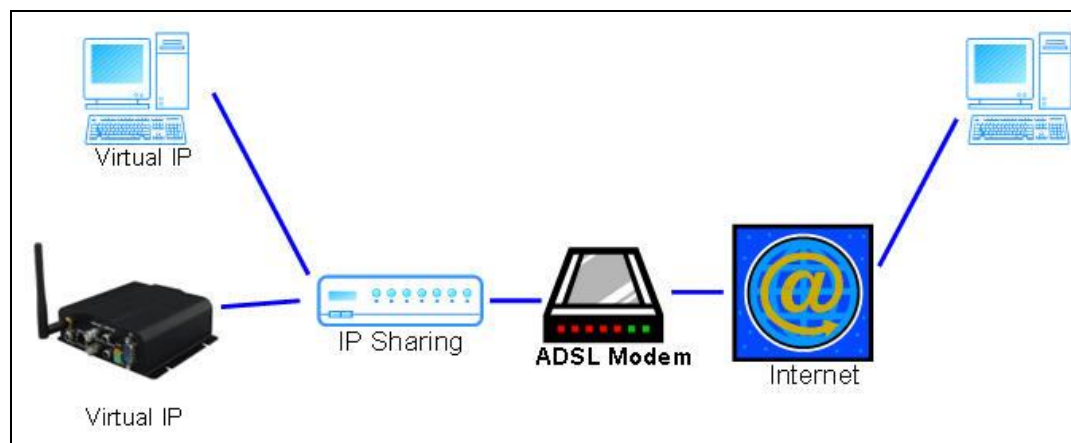

- a. Internet Access : ADSL or Cable Modem
- b. IP address : one real IP or one dynamic IP
- c. Video Server and PC connect to the internet
- d. Device needed : IP sharing
- e. Use virtual IP, set up port forwarding in IP sharing.

VII. Factory Default

- i 、 To recover the default IP address and password, please follow the following steps.
- ii 、 Remove power and press and hold the button in the back of Video Server.

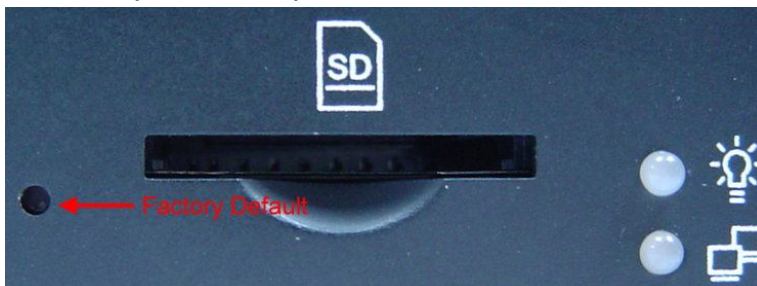

- iii 、 Power on the Video Server. Don't release the button during the system booting.
- iv 、 It will take around 30 seconds to boot the Video Server.
- v 、 Release the button when Video Server finishes proceed.
- vi 、 Re-login the Video Server using the default IP (<http://192.168.1.210>), and user name (admin), password (admin).

VIII. Package contents

- i 、 Video Server
- ii 、 Adaptor
- iii 、 Ethernet Cable
- iv 、 CD title (User manual, IP installation Utility)

Appendix I

SD Card Recommended :

SanDisk 128M	Transcend 128M 80X
SanDisk 256M	Transcend 256M 80X
SanDisk 512M	Transcend 512M 80X
SanDisk 1G	Transcend 1G 80X
SanDisk 2G	Transcend 2G 80X
SanDisk 4G	Transcend 4G 80X