



QuadScan II

MODEL 7400

Four Channel Receiver and Controller Operation & Maintenance Manual



Rev: 7400 Rev F
Date: 5/02/08
ECN 129028
Part Number: 087-0023



Warning: Read & understand contents of this manual prior to operation. Failure to do so could result in serious injury or death.

TABLE OF CONTENTS

INTRODUCTION 1

- Important Safety Issues & Warnings 1
- Unpacking..... 1
- General Description..... 2
- Figure 1 - Model 7400 QUAD-SCAN II Complete Assembly..... 3

QUICK START 4

- Quick Start Programming Menu Tree 5

RECEIVER/CONTROLLER..... 8

- General..... 8
- NEMA-4X Wall Mounted Enclosure 9
- Figure 2- Model 7400 QuadScanII 9
- Figure 2A – Enclosure Side View 9
- Display/Function Assembly 10
- Figure 3 - Model 7400 Front Panel Push Buttons 11
- CPU/Power Supply Boards 11
- Figure 4 - Terminal Strip Layout..... 12

INSTALLATION..... 13

- Selecting the Physical Location 13
- Methods of Physical Mounting 13
- Figure 5 - Mounting Dimensions of Model 7400 15
- Directions for Wiring 16
- Figure 6 - Terminal Block Arrangement on Main I/O – Power Supply Board 17
- Figure 7 – Transmitter Wiring to Model 7400 17
- Figure 8 - Wiring of Normally Open Field Contact into Model 7400 18

Figure 9 - Battery Backup (P/N 096-0719).....	19
Outline & Interconnection Wiring.....	19
SYSTEM OPERATION.....	20
General.....	20
Display Readings.....	20
Visual Indications (LEDs).....	20
Current Loops.....	21
Current Loop Outputs.....	22
Alarm and Relay Operation.....	22
Figure 10 - Alarm Set For Increasing or Decreasing Gas Concentrations.....	23
Latching Alarms.....	24
Energized Relays (Fail Safe).....	24
Common Alarm Relays.....	24
Fail Relay.....	25
Horn and Horn Relay.....	26
Inhibiting Alarms.....	26
Sensor Damping Constant.....	27
Zero DB.....	27
SETUP AND PROGRAMMING.....	28
Power Up.....	28
Programming Setup.....	30
SECURITY MENU.....	31
SYSTEM MENU.....	35
CHANNEL MENU.....	40
OPTIONAL REMOTE RELAYS.....	52
General.....	52
Specific.....	52

NEMA-4X Enclosure	52
Circuit Board	52
Cable	53
Figure 11 - Remote Relay Enclosure – Front View	53
Installation	53
Figure 12 - Remote Relay Assembly Outline Dimensional & Installation Drawing (P/N 096-2691)	54
Wiring	54
Figure 13 - Interconnect Wiring Between 7400 & Remote Relay Assembly	55
Remote Relay Operation	56
Figure 14 - Remote Relay Settings Factory Default	56
Remote Relay Setup and	58
Programming	58
SYSTEM MAINTENANCE	63
General	63
Alarm/Relay Check	63
TROUBLESHOOTING	65
General	65
Channel Test Setup	65
Table 2 - Identify and Locate Possible Malfunctions During System Failure	67
SPARE PARTS	68
SCOTT HEALTH & SAFETY WARRANTY	70
CONTACTING SCOTT HEALTH & SAFETY	71
TECHNICAL SPECIFICATIONS	72
FACTORY DEFAULT SETTINGS	73
Table 3 - Factory Default Settings for Receiver/Controller	73
CUTOMER WORK SHEET	74

LISTING PROGRAMMING SELECTIONS Channel 1	74
LISTING PROGRAMMING SELECTIONS Channel 2	76
LISTING PROGRAMMING SELECTIONS Channel 3	78
LISTING PROGRAMMING SELECTIONS Channel 4	80
LISTING PROGRAMMING SELECTIONS REMOTE RELAYS	82
APPENDIX A	84
Programming Example 1	84
Programming Example 2	103
Programming Example 3	108

Introduction

Important Safety Issues & Warnings

The following symbols are used in this manual to alert the user of important instrument operating issues:



This symbol is intended to alert the user to the presence of important operating and maintenance (servicing) instructions.



Shock Hazard – Disconnect or turn off power before servicing this instrument.

Do not open the case when the unit is powered. Do not open the case in a hazardous environment. Notify all personnel that the unit is out of service before removing from service

Unpacking

All QuadScan II Receivers/Controllers are individually packaged. If the optional remote relay and cable is purchased, it will also be packaged with the receiver/controller. If the optional battery back-up unit is purchased, it will be packaged separately.

Open each box carefully and remove the items. Identify all items shown in **Figure 1** and check your order and packing list for completeness. Examine each item for external damage. If there is any damage or if any item is missing, notify the factory at:

Scott Health & Safety Customer Service

4320 Goldmine Rd. Monroe, NC 28110 USA

Phone: (704)291-8300 Fax: (704)291-8340

For web and email :

www.scotthealthandsafety.com

General Description

The QuadScan II Receiver/Controller provides the electronic interface with the remotely located gas transmitters (oxygen, or combustible). It also provides a continuous digital display of each monitored gas concentration, various alarm displays, and alarm functions which can initiate corrective actions when any undesirable gas concentration is detected

The receiver/controller is offered in a unique configuration, providing a complete four channel unit, but will allow 1, 2, or 3 channels to be purchased within the 4 channel unit. Only the number of channels purchased will be activated for monitoring in this unit.

If you wish to activate additional channels when less than 4 are purchased, contact the Scott Health & Safety factory to purchase the activation codes.

A NEMA-4X wall mounted enclosure contains the microprocessor controlled electronics, displays, and terminal blocks used for the power input, transmitter 4-20 mA current loop inputs and outputs, relay contact outputs, and remote relay outputs.

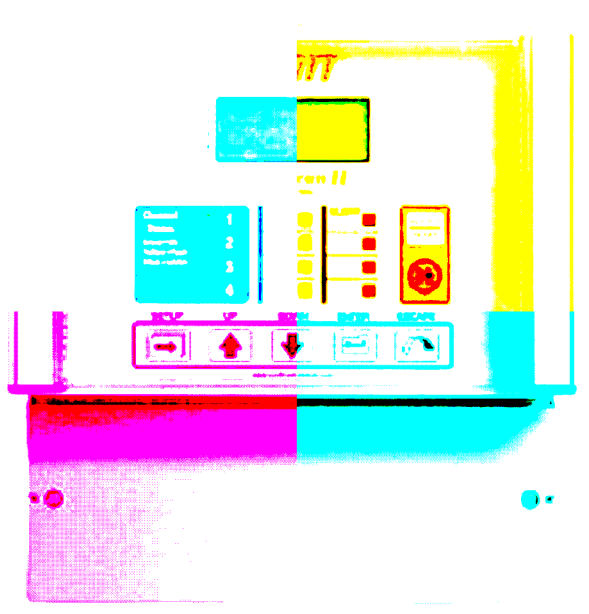

Model 7400 QUAD-SCAN II



Battery Backup P/N 096-0719

(See Figure 14 for Mounting Details & Wiring Interconnect)



Remote Relay Box P/N 096-2691

Comes with 10 feet of Cable
(See Figures 10 & 11 for Mounting Details & Wiring Interconnect)

Figure 1 - Model 7400 QUAD-SCAN II Complete Assembly

Quick Start

1. Install per the physical installation information found in this manual. Refer to Installation drawings for mounting requirements.
2. The 7400 can be powered with either 100-270VAC or 24VDC. Refer to Electrical drawings for information about the power input wiring. Wire according to National Electric Code



Do not apply power until you have finished wiring the complete system, including transmitters.

3. Connect your gas transmitter(s) to the 7400. Refer to **Figure 7**. (***No relay contacts should be hard wired into your system at this stage***)
4. Touch the **Setup** key to enter the programming mode. Use the **Up** or **Down** key to program channels 1 through 4. Press the **ENTER** key once the correct channel is in “Setup” mode. This is seen on the LCD display next to the channel identification number.
5. Follow the menu trees menus [refer to “**Setup & Programming**” for complete details]. Unless your unit was pre-configured for your specific application, refer to “**Factory Default Settings**” for factory default values. To save your programming and finish press the **Escape** key until **SAVE SETTINGS?** is displayed. Press the **ENTER** key and this will complete your programming. When programming other channels, each channel must be completely programmed before you can proceed to another channel.

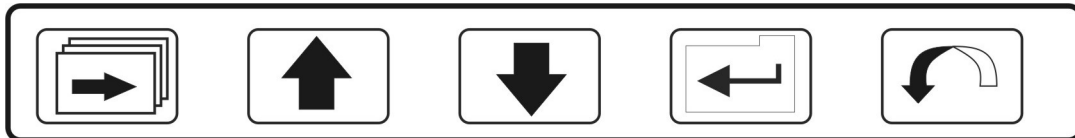

Model 7400 Function Keys

6. Connect common relays [refer “Terminal Block Arrangement” figure for connections]. Refer to “**Alarm and Relay Operation**” for further details on relay functionality.
7. If optional remote relays are to be used, connect per the “Optional Remote Relays” section of this manual.
8. For problems in startup, refer to the “Troubleshooting” section of this manual. Otherwise contact your local Scott Health & Safety representative or the Scott Customer Support team.

Quick Start Programming Menu Tree

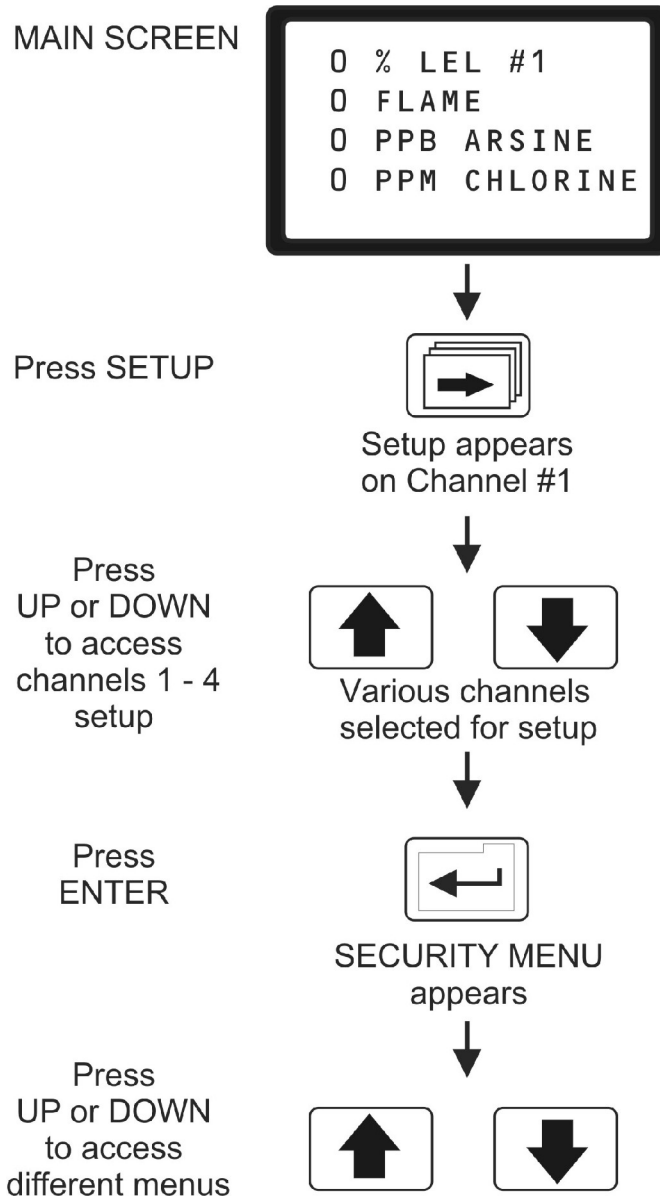

System Menu	Channel Menu	Security Menu
Touch Enter Key	Touch Enter Key	Touch Enter Key
Version 1.# (1)	ON/OFF/IHB: ON	Security Options
Move through options with UP/Down Key	Move through options with UP/Down Key	Move through options with UP/Down Key
Adjust Contrast (6)	Sensor: 4-20mA (1)	Change Password
Inhibit: None/All	Full Scale: ###	Lock System
Set Local Relays (2)	Units: %/PPM / PPB /None	
Relay: Common Fail	Tag: Six character name	
Failsafe: Yes (3)	Damping (S): 0 -10	
F1 F2 F3 F4 (4)	Zero DB (%FS): 0 – 5	
Relay: Common Warn	Inhibit(mA): 2.0 – 20.0	
Failsafe: Yes/No	Fault(mA): 0.1 – 20.0	
W1 W2 W3 W4 (4)	Setup Warning (2)	
Relay: Common Alarm	Warn Set: ###	
Failsafe: Yes/No	Warn Reset: ###	
A1 A2 A3 A4 (4)	Warn Delay: 0 –10 sec.	
Relay: Common Horn	Warn Hold: 0 – 7200 sec.	
Failsafe: No (3)	Warn Latch: Yes/No	
W1 A1 ... W4 A4 (4)	Setup Alarm (2)	
Press Escape Key then UP key to advance to next menu	Same values available under Warning	
Set Remote Relays (5)	Cal Loop Input	
Remote Relay 1 – 8	Cal Loop Output	
Move through all 8 relays with UP key. Press ENTER to adjust.		
Failsafe: Yes/No		
W1 (4)		
Press Enter key to step back to relay 1 - 8		
Time: ##:##		
Date: ## / ## / #####		

Notes:

1. These values are factory set and cannot be adjusted.
2. To access the submenu associated with these parameters, press the ENTER key. To bypass the parameters, press the UP/DOWN key. Once a submenu value has been programmed, press the ESCAPE key to go back to the main menu.
3. The common fail relay can only be programmed as failsafe. The common horn relay can only be programmed as non-failsafe (otherwise the horn enunciator would always be on). Press the ENTER key to continue with the programming.

4. The relays can be configured for any configuration desired. W = warn, A = alarm, F = fail and the numbers 1 – 4 designate channel number. & = And logic, | = Or logic and () are used to group channels. Refer to the **“Remote Relay Operation”** for additional information. Press the ENTER key when the programming is complete and the UP/DOWN key to go to a different menu.
5. The SET REMOTE RELAYS menu is only available if this option is physically connected to the 7400 controller. Otherwise the menu is not displayed.
6. The CONTRAST menu is selected by pressing the ENTER key and then adjusting the contrast with the UP/DOWN key.

Receiver/Controller

General

The QuadScan II Receiver/Controller is a 4 channel gas receiver designed to operate with any 2, 3, or 4 wire gas transmitter. The unit has 3 major components:

- NEMA-4X wall mounted enclosure
- Display/function assembly
- CPU/power supply boards

All setup functions are completely programmable using the switches located on the display/function assembly. An internal alarm horn is mounted within the enclosure providing 85 db at 1 ft.

Four 5A SPDT relays are included which are common to all 4 channels. Relays provide the following:

FAIL Activates on a failure of the current loop signal from the field device or an internal failure such as power loss.

WARN Activates on a programmed set point corresponding to an increasing or decreasing gas concentration, flame signal or any other analog signal.

ALARM Activates on a programmed set point corresponding to an increasing or decreasing gas concentration, flame signal or any other analog signal.

Note: Alarm set points are typically programmed for a higher gas concentration than the warn setpoint when monitoring an increasing gas concentration, including toxic and combustible gases. For a decreasing gas concentration application such as oxygen, the alarm set point is set lower (e.g. 16% v/v) than the warn set point (e.g. 19.5% v/v). Although, the alarm set point can be programmed to detect rising oxygen concentration and the warn setpoint programmed to detect decreasing oxygen concentration.

HORN Programmed to activate on for warn, alarm or both.

An optional remote relay assembly in a NEMA-4X wall mount enclosure can be provided when individual alarm outputs are required. There are six 5A SPDT and two 5A DPDT relays. These relays can be assigned or zoned to any input channel.

The Quadscan II receiver controller will not operate with out a source of electricity. If you require an electricity source for short term outages either provide another source of electricity such as a battery backup. An optional battery backup assembly is also available providing 2.5 amp-hours of DC power to the unit. Factory supplied battery (Scott Health & Safety P/N 004-0002) is a Sonnenschein Part No. A212/35, 12 volt 2.5 amp hour battery.



Warning: Replace the battery only with the same type and rating.

Failure to do so may be dangerous. Dispose of batteries per applicable local, state and federal regulations or contact Scott Health & Safety or your local Scott authorized distributor.

NEMA-4X Wall Mounted Enclosure

The enclosure measures 9.32 inches high x 9.19 inches wide x 5.38 inches deep (233 mm x 203 mm x 136 mm). It provides a watertight, dust tight and corrosion resistant enclosure for outdoor or indoor mounting.

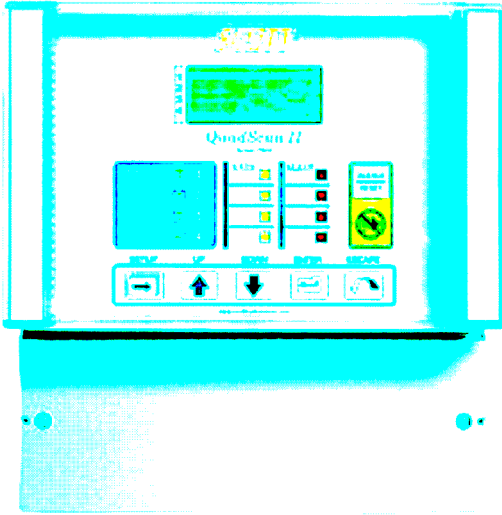

A door covers the digital/function front panel and can open to the left or right for easy mounting in restricted areas. All displays; gas concentration, alarm LEDs, and the function switches, are visible through the clear opening in the enclosure door. A cover plate is located at the bottom front area of the enclosure and when it is removed, access is available for all the terminal strips used for input and output wiring. See **Figure 2A** for correct installation of bottom cover plate.

Figure 2- Model 7400 QuadScan II

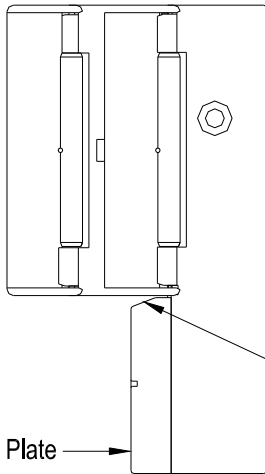

Figure 2A – Enclosure Side View

The bottom compartment leaks if cover plate is installed incorrectly. Make sure angled side of cover is toward top.

Bottom Cover Plate

Figure 2A
(Enclosure Side View)



Display/Function Assembly

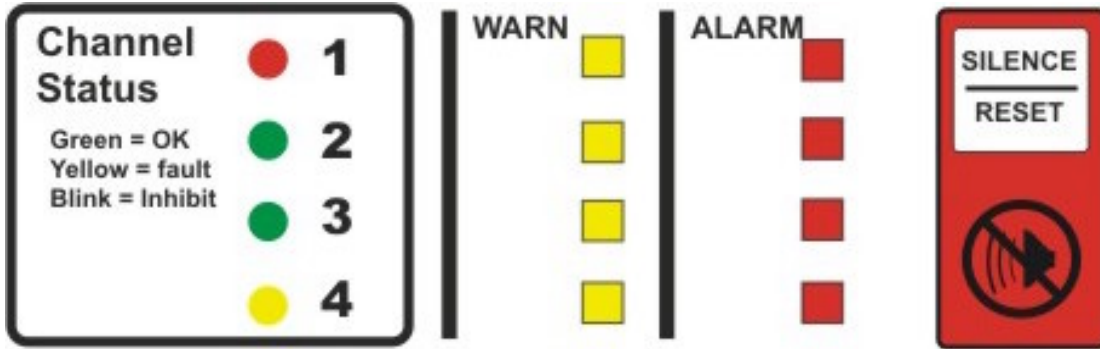

The individual visual display of absolute value of the gas concentrations, alarm status, and channel status for all active channels provides the status of the gas/flame detection system.

Operator intervention and/or automatic alarm corrections can be made from the information displayed by this unit. Gas Concentration is displayed on a LCD in units of PPM, PPB, % and none (flame applications) in any combination of the four.

Individual Channel Status is displayed by a 2 color LED for each active channel:

- Channel OK** Green
- Current Loop Fault** Flashing yellow (flashing until the reset button is pressed, and then it becomes solid yellow).
- Channel Inhibited** Flashing yellow/green (an inhibited channel cannot be set to steady color)

Individual alarm statuses are displayed for warn and alarm events by a yellow (warn) and red (alarm) colored LED for each active channel. The individual alarm LEDs flash when an alarm condition is detected and remain flashing until acknowledged by the reset button.

The function section of the unit is used for all programming and setup requirements. Five tactile feel switches are provided to implement the following functions:



SETUP To activate programming entry to the system. This also moves the alphanumeric selection one position to the right on the LCD each time the switch is activated.



UP To scroll up through the various channels or programming options.



DOWN To scroll down through the various channels or programming options.

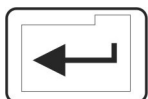

ENTER To enter the required programmed option selected from the UP or DOWN switches.

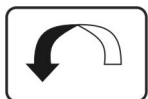

ESCAPE To return to a previous menu or selection each time the switch is activated. This will eventually return to the gas concentration display.

NOTE: During the programming mode, if a switch is not activated for 20 minutes, the display automatically returns to the gas concentration display and all previous programming will be lost.

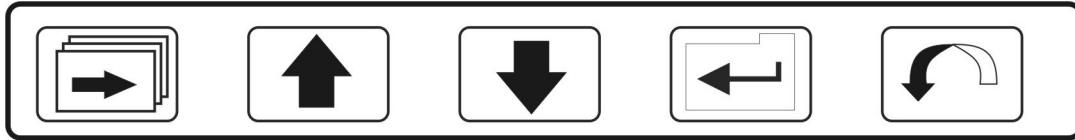

Figure 3 - Model 7400 Front Panel Push Buttons

CPU/Power Supply Boards

The power supply board is located on the inside back surface of the enclosure. The CPU/display board is located directly behind the display/function panel. They are connected together via a ribbon cable.

The CPU board is used to store the system configuration, operation data and all parameters entered from the function switches on the display/function assembly.

All information is stored in non-volatile electronically erasable programmable read only memory (EEPROM), which allows all information to remain stored during a power disconnect.

The power supply board accepts AC and DC power inputs to the system and supplies the various circuit requirements and the transmitter loops. The system will operate on any AC voltage between 90 to 280 VAC, 50/60 Hz. or DC voltage between 10 to 30 VDC (nominal 24 VDC). When a battery backup system is connected to the unit and if the AC power should fail, the system will automatically switch over to DC power without interruption.

There are 4 common relays located on the power supply board providing SPDT 5A contacts. The warn and alarm relays can be programmed for normally energized (fail safe) or normally de-energized operation as well as latching/non-latching. The fail relay operates in a normally energized (failsafe) mode only. The horn relay operates in a normally de-energized mode only.

When any of the following conditions exist, the relay contacts change state:

Fail – When the 4-20 mA loop from the transmitter falls to the programmed fault level.

Warn – When a gas concentration exceeds a pre- set programmed level (set point), this is normally not a hazardous condition. When this happen, the increasing or decreasing gas level concentration needs to be closely monitored.

Alarm – When a gas concentration exceeds a pre-set programmed level (set point) which is set higher or lower for oxygen monitoring than the warn relay. When this happens, corrective action should take place.

Horn – This relay provides a contact for a remote horn and will change state on either/or warn or alarm condition. The local buzzer will also activate. The horn relay will de-energize (turn off) once the silence/reset button is pushed EVEN WHEN A WARN/ALARM EVENT IS STILL OCCURRING.

Terminal blocks are provided for the following input and output requirements:

TB1 – 2, 3, or 4 wire 4 – 20 mA inputs for Channels 1 and 2

TB2 – 2, 3, or 4 wire 4 – 20 mA inputs for Channels 3 and 4

TB3 – AC power input

TB4 – Battery backup input

TB5 – 2 wire 4 – 20 mA outputs for 4 channels

TB6 – Remote relay outputs for 8 relays

TB7 – Contact outputs for fail, warn, alarm, and horn relays provide normally closed (NC), common (C) and normally open (NO) contacts for customer use.

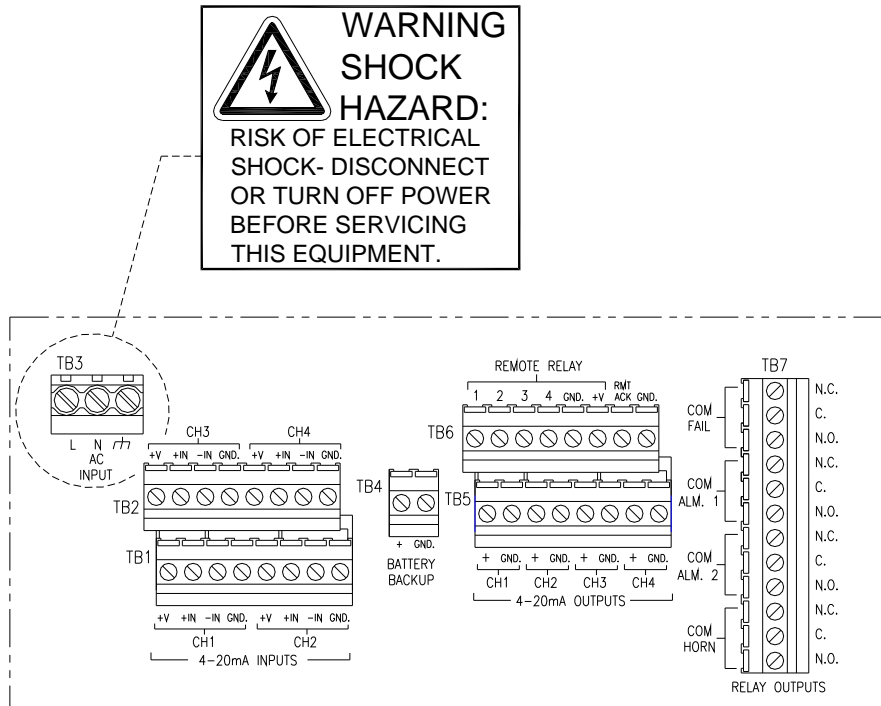

Figure 4 - Terminal Strip Layout

Installation

The installation information is presented in three sections:

- Selecting the appropriate physical location
- Methods of physical mounting
- Directions for wiring

Note: Remote relay installation is covered in a separate section.

Selecting the Physical Location

The specific location for the receiver/controller is the responsibility of the user.

Use the following guideline to determine the appropriate location for the unit:

- Do not exceed the temperature range of -13° F to 122° F (-25° C to 50° C)
- Must be located in non-hazardous areas
- Should avoid extreme vibration, dampness and temperature variations
- Avoid direct sunlight or provide a sun screen
- Should have easy visibility and access for the operator
- Must allow sufficient clearance for wiring, maintenance, set up and programming



WARNING: If the equipment is not installed as prescribed by the manufacturer, the accuracy of the reading may be low resulting in

Methods of Physical Mounting

The enclosure dimensions are 9.3 inches high x 9.2 inches wide x 5.4 inches deep and weighs 4 lbs. (237mm H x 233mm W x 137mm D and 1.75 Kg) Refer to **Figure 5** for recommended clearances and mounting hole locations. Locate the 6 mounting holes at the desired location and drill for the proper bolt size. It may be advisable to perform the following steps before moving to the job site. The display/function assembly and bottom front cover plate will need to be removed from the base enclosure to access the mounting holes. Unless this is an instrument relocation, the power hasn't been wired in yet. **Be sure power is removed from the unit before disconnecting the flat ribbon connector.**

1. The display/function assembly can be removed by inserting a small blade screwdriver into the 3/8 "long slot located on the **right side**, closest to the back of the enclosure.
2. Insert the screwdriver into the slot and lever it outwards, dislodging the hinged section of the base enclosure.

3. Move the hinged section away from the side of the enclosure, disengaging it from the base.
4. Tilt the assembly away from the base enclosure and unplug the ribbon cable from the display circuit board. Power must be off before removing ribbon cable.
5. On the left side, follow steps 1 – 3. The assembly will then lift clear of the base.



Caution: All circuit board components are now exposed. Extreme care must be taken not to damage these components.

Using #8 mounting screws or bolts, mount the enclosure to the wall or other suitable structure via the 6 mounting holes in the enclosure.

Use the following steps to attach the assembly to the base:

1. Position the display assembly over the base.
2. On the left side, move the hinge section out from the assembly and make sure it has engaged the hinge rod.
3. Push the top of the hinge section in towards the side of the assembly, locking the left side to the base.
4. Pull the right side of the assembly away from the base and reconnect the ribbon cable.
5. On the right side, follow steps 2 – 4 to complete closing the assembly to the base.

Note: The bottom of the enclosure is pre-drilled for cable entry. Clearance should be allowed for the cables or conduits when mounting the enclosure. Use all NEMA-4X rated components for cable entry to maintain the rating of the enclosure.

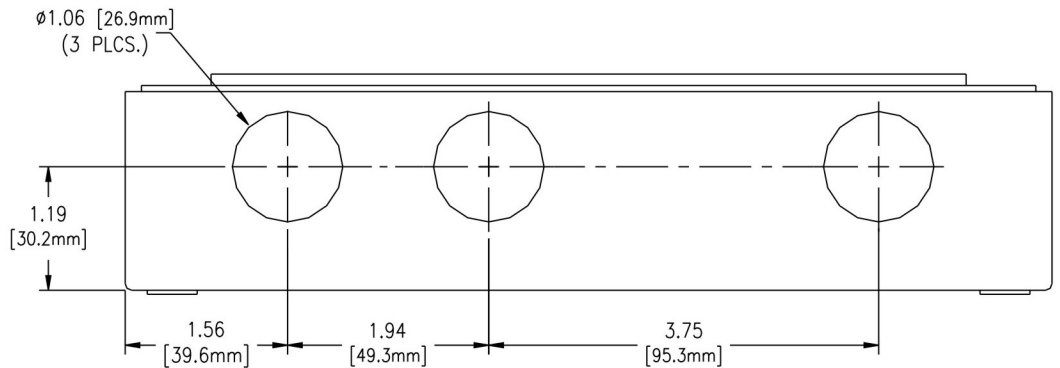
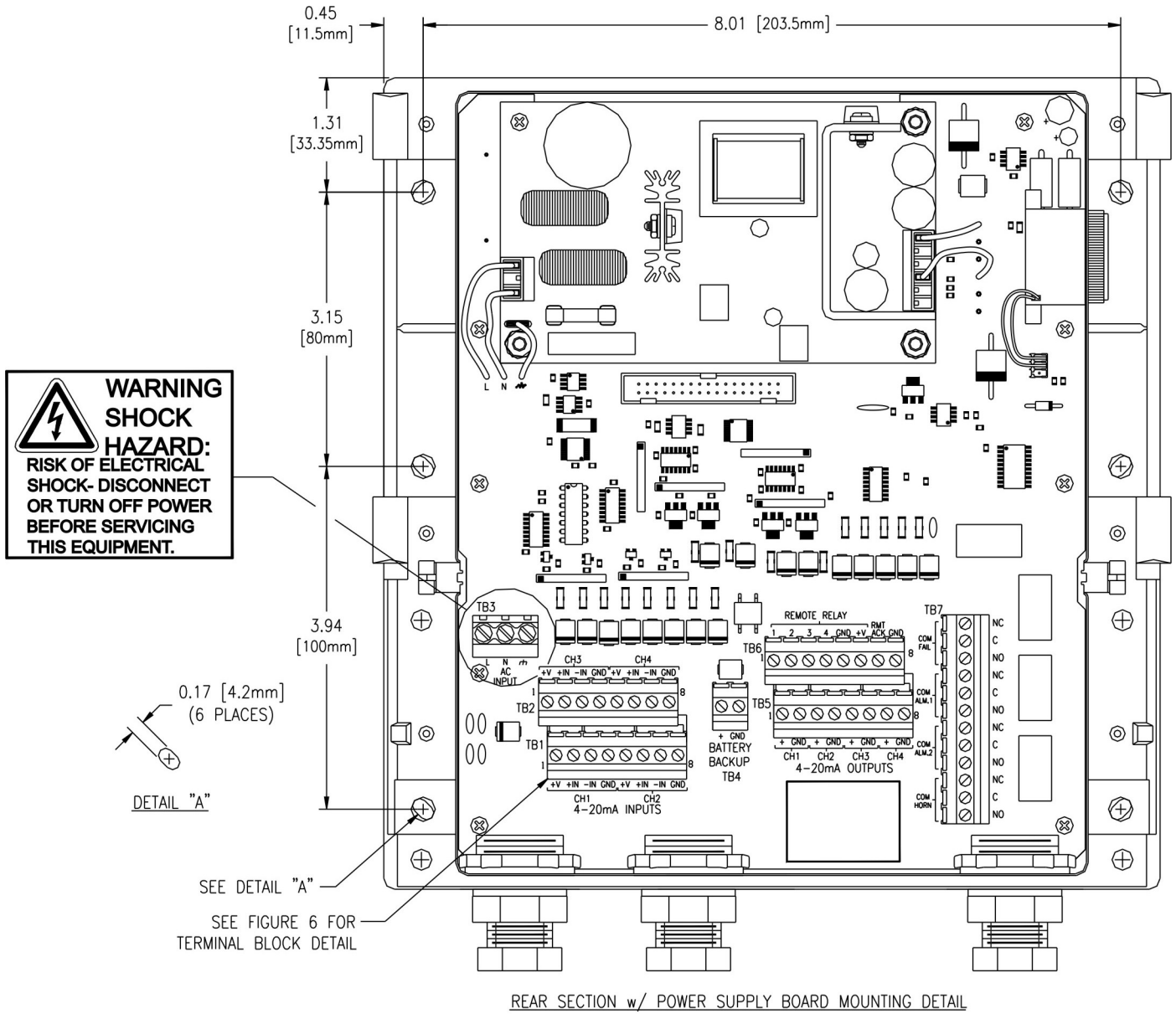

Figure 5 - Mounting Dimensions of Model 7400

Directions for Wiring

Remove the cover plate located at the front bottom of the enclosure; this will expose all terminal blocks. The main I/O – power supply board is labeled with the appropriate function and wire designation to implement correct wire hook up. Refer to **Figure 6** for the terminal block layout. Route the power, ground, relay and signal wires through the entry holes in the bottom of the enclosure. Note: Power, grounding and relay wiring must be separated from signal wiring.



CAUTION: Common relay contacts and optional remote relay contacts to be wired to external devices should not be connected at this time. Programming must be completed before wires are connected. Connecting the wires before programming is complete, may cause alarms and relays to activate. If alarm by pass systems are in place and can be activated, this caution can be ignored.

Incoming AC power to Terminal Block TB3 (See **Figure 6**) is to be connected from a certified/approved power switch or circuit breaker and is to meet all requirements of applicable local and state electrical codes. The power switch and/or circuit breaker are to have proper electrical ratings to operate as a mains disconnect device. Locate the power switch/circuit breaker in close proximity to the 7400 Receiver. Power ON is to be so designated with an “I” and power OFF with an “O”. Wiring from the power source to the 7400 receiver is to be service rated in accordance with local and state electrical codes.

Refer to **Figure 7** for the current loop wiring from transmitter to Model 7400 Quad Scan II.- Four Channel Receiver and Controller.

Figure 6 - Terminal Block Arrangement on Main I/O – Power Supply Board

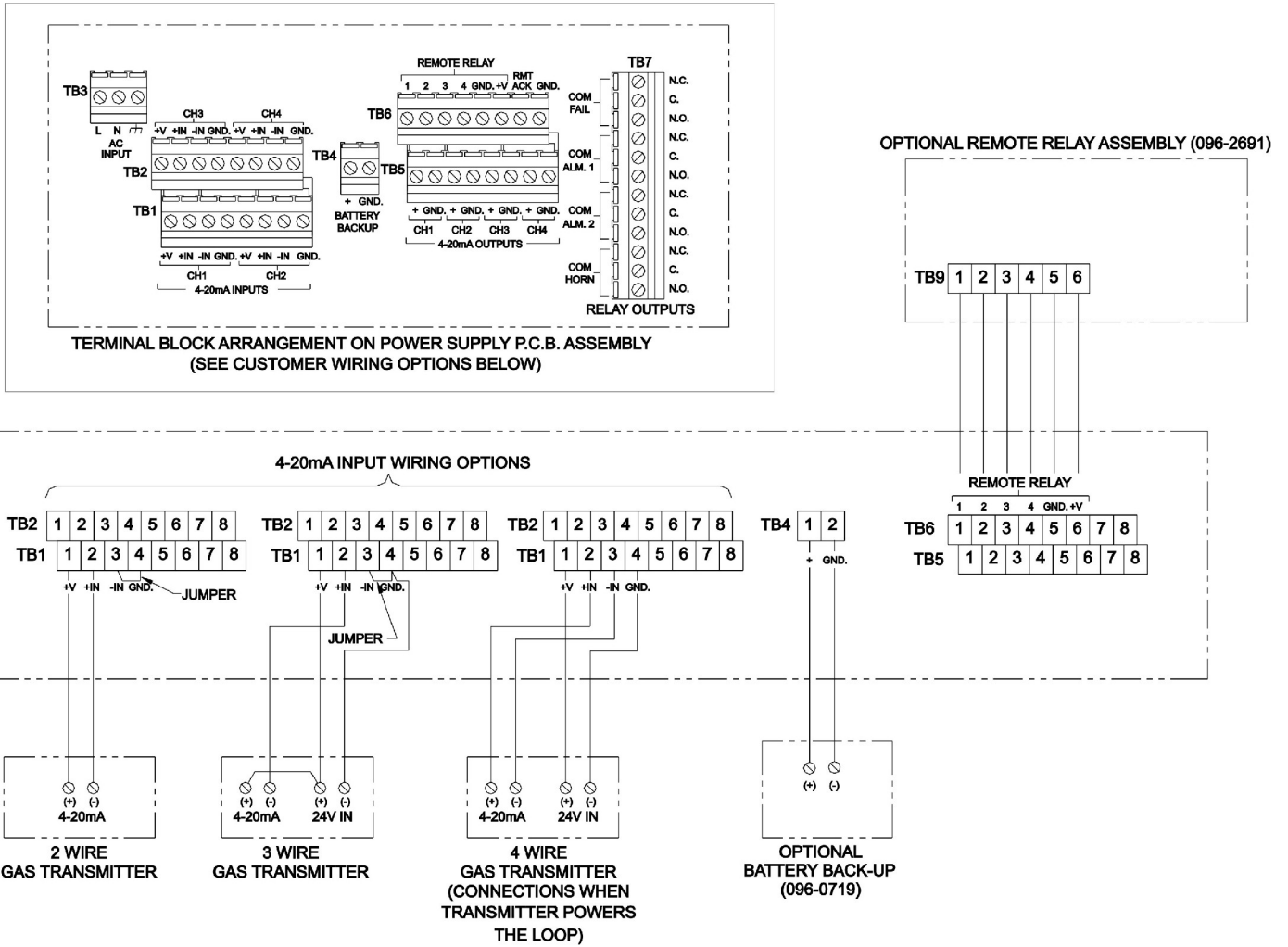

Figure 7 – Transmitter Wiring to Model 7400



CAUTION: All relay contacts are rated 5A Resistive Load. Any in-rush current above this value can cause damage to the unit.

Dry Contact Input Wiring

Dry-contact inputs can be applied into the model 7400 analog input channel. This can be done, for example, for smoke or fire detectors. **Figure 8** illustrates how to wire a normally open dry contact into the analog input.

IMPORTANT: This application requires 24VDC $\pm 2\%$ to be present between +24 and COM as is typically the case when the AC is used to power the 7400. Operating the 7400 off of battery backup could provide voltage values significantly different than 24VDC.

To use this application, the full scale range is set to 0 – 100%. The reading will be 0 with no alarm condition and approximately 100% of scale when the field contacts operate. Connect resistors and relay as in the figure.

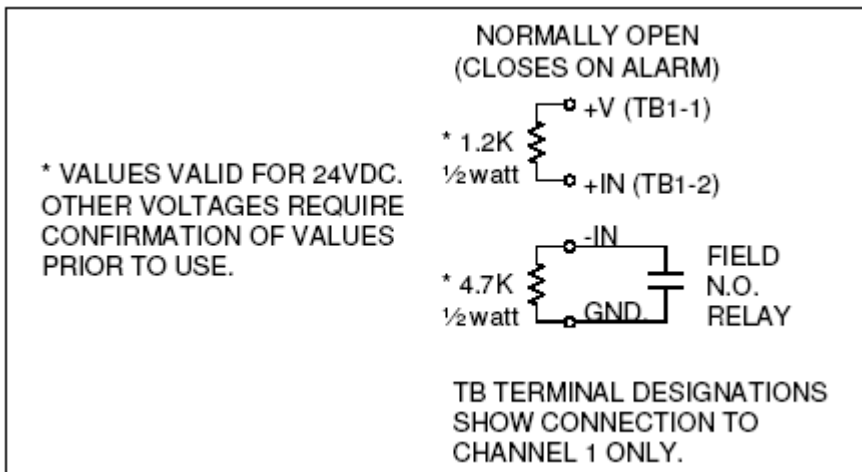
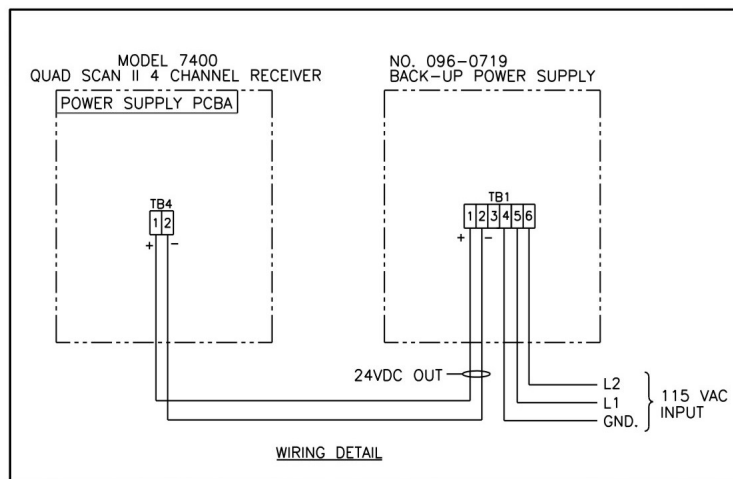
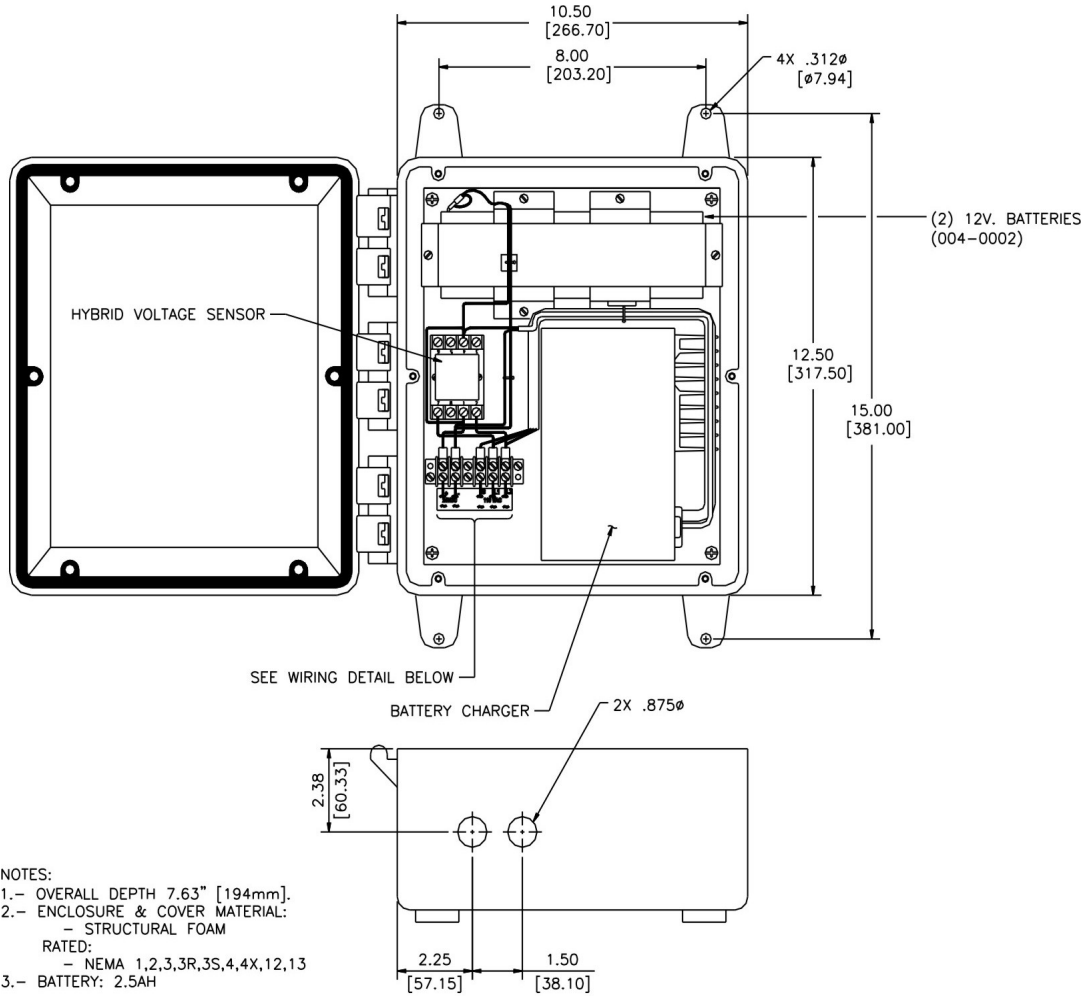

Figure 8 - Wiring of Normally Open Field Contact into Model 7400



**Figure 9 - Battery Backup (P/N 096-0719)
Outline & Interconnection Wiring**

System Operation

General

The QuadScan II allows up to 4 inputs of 0/4 - 20 mA and converts these inputs to digital displays on a LCD. An input current of 4 mA corresponds to a display of 0.00, and an input current of 20 mA corresponds to the programmed full-scale digital display. Displays are checked against programmed alarm levels (set points) to illuminate LEDs, activate relays, and sound the internal horn. The input current loops are also used to generate isolated 4 - 20 mA output current loops.

Display Readings

The LCD is capable of displaying digital ranges from 000 to 1999. A decimal point may appear in the digital display, which is set automatically by the programmed channel full-scale display. Possible full-scale displays with respective digital ranges are shown below.

<u>Full Scale</u>	<u>Decimal Precision</u>
1.00 – 9.99	2 digits
10.0 – 99.9	1 digit
100 – 1999	0 digits

The decimal point is fixed and does not change once set.

The LCD may be programmed for one of the three gas concentration units or none at all.

<u>%</u>	<u>Percent</u>
PPM	Parts Per Million
PPB	Parts Per Billion
none	--

Contrast may be set for the LCD during setup and programming, which may provide a clearer view of the digital display from various angles.

The LCD can be programmed with up to a maximum of six (6) alphanumeric characters to display specific customer information such as transmitter location, area identification etc.

Visual Indications (LEDs)

The visual indications located on the digital/function assembly are divided into two distinct sections; channel status and alarm status. These sections are located just below the LCD.

Channel Status

The channel status essentially provides a summary of the health of each active channel. Four LEDs are used, one for each of the 4 channels. Each LED provides 3 functions:

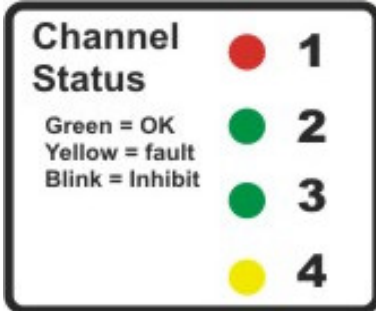

Channel OK - Green

Channel in Fail - Flashing yellow, (solid yellow when reset button is pressed)

Channel Inhibited - Flashing yellow/green

Alarm Status

Each channel has 2 LEDs, warn (yellow), for low alarm status and alarm (red) for high alarm status. The operation of these LEDs are controlled by the display indication (gas concentration) and the alarm settings(set points). During normal operation these LEDs are not illuminated, when an alarm condition is detected, its respective LED will illuminate in a flashing mode.

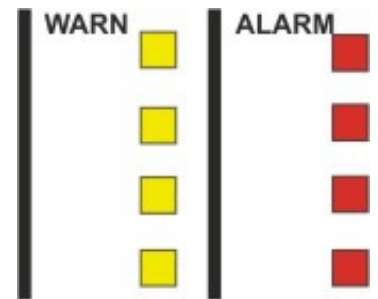

The warn LED can be illuminated by itself or both the warn and alarm LEDs can be illuminated at the same time, depending on the level of the gas concentration detected. The LEDs will remain flashing until the alarm condition has passed or until the alarm reset pushbutton is pressed. If the alarm condition is still present after the alarm reset has been pressed, the LEDs will remain illuminated but not flashing. If the alarm is programmed as latching, the LED will extinguish only after pressing the alarm reset when alarm conditions are not present (above or below the reset point). Warn represents the first stage of alarm while alarm represents a more serious event.

Current Loops

During factory calibration, each current loop is exposed to a precise 4.00mA and 20.00mA input signal which the CPU stores as digital values in EEPROM. These values are then used to determine the unknown input current during normal operation. The computed mA input value is then used for computing the digital display, where 4mA is equivalent to 0.00, and 20.00mA is equivalent to the programmed full-scale display.



WARNING: In normal operation the 4-20mA input current loop is checked for a signal that falls down to or below the programmable fault level. The factory default level is 3.5mA but can be programmed as low as 1.0mA.

Applications such as oxygen deficiency monitoring must have the FAULT level programmed below 4 mA.

When the input signal reaches the fault level, the relays are turned off after the alarm reset button is pressed. Therefore setting the alarm level below 4mA (0.0% v/v O₂) will prevent the 7400 from shutting off the warn and alarm relays accidentally.



Oxygen applications monitoring both increasing AND decreasing oxygen concentration must have the INHIBIT level programmed below 4 mA.

When the input signal reaches the inhibit level, the relays are turned off. Therefore setting the alarm level below 4mA (0.0% v/v O₂) will prevent the 7400 from shutting off the warn and alarm relays accidentally.

Current Loop Outputs

Each channel provides a 2 wire isolated current loop output which follows the current loop input, except during the following conditions:

- Alarm inhibit:** Current loop output goes to programmed inhibit level.
- Channel Off:** Current loop output goes to programmed inhibit level.
- Input Under range (below 4mA):** Current loop output follows the current loop input until it reaches the programmed fault level. At that stage, the value remains at the fault level no matter how far down the current input goes.
- Internal Faults:** Current loop output goes to the programmed fault mA level.

Alarm and Relay Operation

When an increasing or decreasing toxic, explosive, or oxygen deficient gas condition or flame is detected, the QuadScan II provides the means to alert to this potential hazard. An increasing gas concentration is normally associated with toxic or combustible gas atmospheres, while decreasing concentrations are associated with oxygen deficient atmospheres.

An alarm due to an increasing concentration is activated (changes state) when the displayed digital indication is at or above the set point and is inactive when the digital indication is at or below the reset point. Flame detectors provided by Scott Health & Safety provide an increased output analog signal when a flame is detected.

An alarm due to a decreasing concentration is activated (changes state) when the digital indication is at or below the set point and inactive when the digital indication is at or above the reset point.

Protection is provided by the activation (change of state) of alarm relays, which can be used to activate protective devices such as deluge systems, shut down systems, horns, beacons, etc. Two common relays (warn and alarm) each with 5A SPDT contacts provide this interface. An optional relay assembly provides eight additional relays that can be configured for any channel.

Set Point - A programmed numerical value that is compared to the actual gas concentration or percentage of full scale. When the concentration is equal to this numerical value, the associated relay activates (changes state) immediately. (See Set Delay).

Set Delay (Off Time) - A delayed relay activation can be programmed for a specific time delay until a constant gas concentration is established at or above the set point (toxic/ combustible or flame applications) or at or below the set point (oxygen deficient applications) for that specific programmed period of time.

This timed delay can prevent nuisance alarms that may occur due to such things as lightening storms, etc. The off time delay can be programmed for up to 10 seconds, and once activated the timer is decremented once a second until the time expires.

Alarm Set For Increasing Gas concentration

Set Point > Reset Point

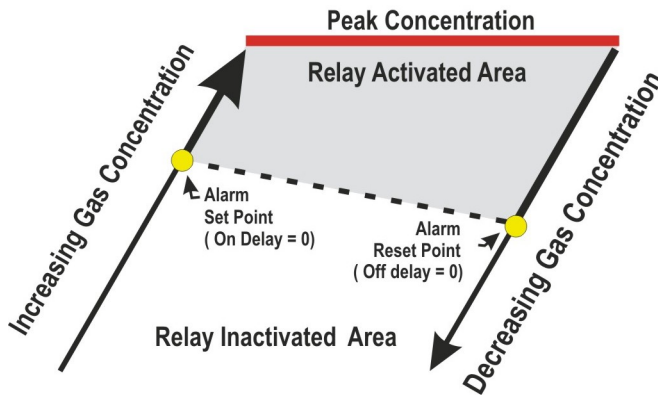

Alarm Set For Decreasing Gas concentration

Set Point < Reset Point

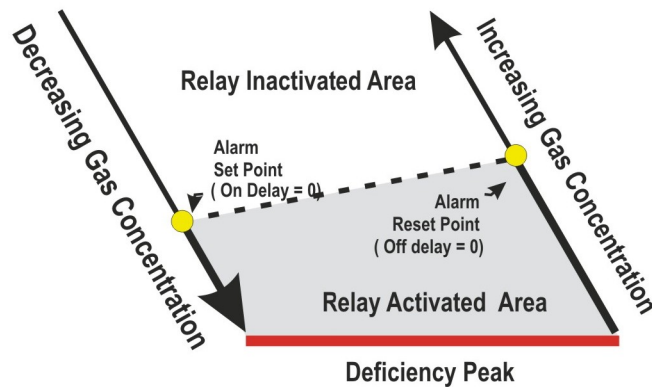

If the channel is not inhibited (channel status LED flashing), the associated relay(s) will be affected (non-energized relays will be energized, and energized relays will be de-energized). Timer activation can be set to 0 at which time relay activation will be immediate as described under Set Point.

Reset Point - A programmed numerical value, which is compared to the actual gas concentration. When the concentration is equal to this numerical value, the associated relay de-activates (changes state) immediately (See Reset Delay). This is sometimes referred to as hysteresis.

Reset Delay (On Time) - A delayed relay de-activation can be programmed for a specific time delay to provide additional on time for exhaust fans or other corrective devices.

The on time delay can be programmed for up to 7200 seconds (2 hours) and once activated the timer is decremented once a second until the time expires.

When the reset timer has expired, the alarm(s) are deactivated and the channel warn and alarm LEDs are turned off, unless the alarm(s) are programmed for latching. Latching alarms require depressing the alarm reset in order to deactivate the alarm. Pressing the alarm reset button while the reset timer is in the process of counting down will automatically expire the timer. The alarm will be deactivated. Timer activation can be set to zero (0) disabling this feature.

Figure 10 - Alarm Set For Increasing or Decreasing Gas Concentrations

Latching Alarms

Latching alarms describe the behavior of the software emulating a self latching relay. The coil is energized through one of its own contacts, thereby holding itself energized. This type of relay requires an interruption in the latching circuit for the relay to be de-energized. This is the function of the alarm reset button.



This feature is implemented in software for alarms warn and alarms programmed with the latching option. Once an alarm has occurred, the associated LED and relay(s) will be held in their alarm state even though the original alarm conditions have returned to normal. The LED and relay(s) will not be returned to normal until the alarm condition has subsided and the alarm reset button has been pressed.

Energized Relays (Fail Safe)

Normally, an alarm relay will remain de-energized until an alarm occurs, at which time the coil is energized. This describes a non-failsafe relay. When an alarm relay is programmed to be failsafe, its coil remains energized in normal, no alarm condition, and de-energizes during an alarm. This permits the relay contacts to be used to detect power failures as well as their assigned function.



Safety Suggestion! It is a safe practice to make all optional remote relays programmed as fault relays, failsafe, so that power failures may be sensed. A separate power source is required for the alarm devices, e.g. horns & lights, if used to detect power failures.

The common fault relay is energized (failsafe) and cannot be programmed otherwise

The warn and alarm relays by factory default are set for de-energized operation but can be programmed otherwise.

Note: Any relay, programmed as energized (fail safe), will have contact operation reversed to the terminal strip labeling. All labeled normally open (NO) contacts will operate as normally closed (NC) and all labeled (NC) contacts will operate as (NO).

Common Alarm Relays

There are four SPDT common alarm relays located on the CPU/power supply board.

- Fault Relay** Activated when any channel fault is detected.
- Warn Relay** Typically activated when any channel low alarm set point is exceeded. This relay can be programmed to activate off any one channel or group of channels for either warn and/or alarm level.
- Alarm Relay** Typically activated when any channel high alarm set point is exceeded. This can be programmed to activate off any one channel or group of channels for either warn and/or alarm level.
- Horn Relay** This relay can be programmed to activate off any one channel or group of channels for either warn and/or alarm level.

All relay contacts are rated 5 A **Resistive** 24 VDC - 250VAC.

The warn and alarm relays can be programmed for energized (failsafe) or de-energized (non-failsafe). This is done in the SYSTEM MENU. The latching or non-latching operation is programmed for each channel input. This is done in the CHANNEL MENU. When programmed for latching operation, the reset button must be depressed to release the relay from this condition, but will only release the relay if the alarm condition has passed. It is possible to have one or more channels programmed as latching and one or more programmed as non-latching. When this happens, if channel inputs from both groups go into alarm/warn then the latching program takes precedence over the non-latching program.

Different corrective actions are normally required when sensor/transmitters are located in dissimilar areas. Set points could differ for the gases being monitored, therefore, the common relays will not provide the required results when this situation occurs. However Scott Health & Safety has anticipated such situations and can provide an optional remote relay assembly, allowing alternative alarm combinations.

Fail Relay

The common fail relay is provided only to be used in the energized state (failsafe). The remote relay assembly allows for a relay to be configured as a non-failsafe fault output. There are no set or reset timers associated with fail alarms. When a fault is detected, fail alarms are activated immediately. When the fault conditions are cleared, fail alarms are immediately deactivated.

When a fault condition is detected, the channel status LED will change from a solid green to a flashing yellow/green. (It turns solid yellow if acknowledged by pressing the reset button.) The common fail relay will change state from energized to de-energized.

If a channel is in a warn or a warn and alarm condition when a fault occurs on that channel, Table 1 defines the relay(s) state when in a latched or unlatched programmed mode.

	Relays Latched		Relay(s) Changed State	
	No	Yes	Yes	No
Fault Condition 1				
Warn		X		X
Alarm				
Fault Condition 2				
Warn	X		X	
Alarm				
Fault Condition 3				
Warn	X		X	
Alarm	X		X	
Fault Condition 4				
Warn	X		X	
Alarm		X		X
Fault Condition 5				
Warn		X		X
Alarm	X		X	
Fault Condition 6				
Warn		X		X
Alarm		X		X

**Table 1 – Relay States
(when in a Latched or Unlatched
programmed mode)**

By latching the existing alarm state, safety lights, horns and fans under control of the warn and alarm relays, they continue to operate, even if the current loop has shorted or opened, or the transmitter has ceased to operate.

When an operator has determined that conditions are actually safe, the alarm reset may be pressed to de-activate alarm LEDs, and warn and alarm relays on that channel. This can only be determined after the fault has been corrected, as the channel display indicates -24 while the fault condition exists. By preventing new alarms, accidental shorts or opens occurring on the current loop input will not cause false alarms. This works only if the short or open causes the current loop input to drop below the programmed mA fault level. During any fault conditions, the current loop output drives the programmed fault mA level.

Horn and Horn Relay

An internal horn will sound when a warn or alarm condition exists IF THE HORN RELAY WAS PROGRAMMED FOR THIS OPERATION. This programming is done in the SYSTEM MENU. At the same time, the horn relay located on the CPU/power supply board will change state. Pressing the alarm reset button, regardless of the gas condition, silences the internal horn and changes the state of the relay. The horn and horn relay will not activate again until the alarm condition subsides and then reoccurs, or a new alarm occurs.

Note: The horn and horn relay will not be active for an inhibited channel.

Inhibiting Alarms

All alarm relays, warn, alarm and fail for an entire channel can be inhibited, but it is not possible to inhibit alarms individually. There are several methods for inhibiting alarms:

Power On Reset-A timed inhibit mode of 65 seconds is initiated when the unit is first powered on. This permits sensors to stabilize and prevent false alarms.

Reprogrammed Channel-The channel enters a timed inhibit period of 35 seconds upon exiting the programming routine. The process of selecting and programming a channel automatically provides an inhibit condition when the channel is programmed "ON" from the Channel Menu. This provides immunity against false alarms for improperly configured changes. Note that alarms are not processed on a channel being programmed and that the channel's relays remain in their current state until exiting the programming routine.

Programmed Channel Inhibit-A channel may be permanently programmed into an inhibit mode for an indefinite period when the "IHB" is selected from the Channel Menu. Once programmed, the channel will remain inhibited even when power is removed and then restored. This is provided for performing maintenance on a specific channel. Note: The associated remote relays will also be inhibited for this specific channel.

System Inhibit-All channels can be inhibited at one time by programming the "ALL" selection from the System Menu. This is provided for performing maintenance on the total system. Note: All remote relays are inhibited when this selection is made.

Current Loop Input-A channel is inhibited when the current loop input is equal to the programmed inhibit level (factory default is 3.6mA). The channel inhibit is immediately removed when the current loop input is outside the tolerance of $\pm 0.25\text{mA}$.

Sensor Damping Constant

Provides a damping time constant which allows the program selection from 0 to 10 seconds. Damping is the amount of time it will take the unit to reach 63% of its final value when a step change occurs to a known concentration of gas. The time to reach 95% of final value may be estimated by multiplying this setting by 3. Note: the lower the damping time constant, the more unstable the reading may be.

Zero DB

Provides a dead band programmable from 0 to 5 % of full scale for a specific channel. The percentage of full scale selected will not allow the "0" display (and 4mA output) to change until the selected percentage has been exceeded.

Setup and Programming

Power Up

When power is applied to the QuadScan II the following LCD displays are shown, also the internal horn sounds for 2 seconds:

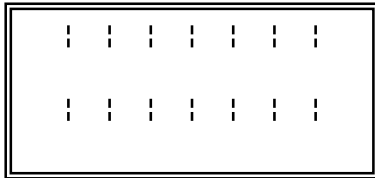

Shown for 2 seconds

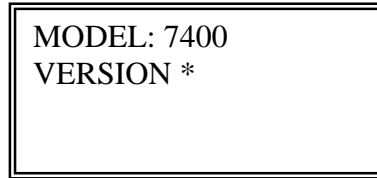

Shown for 5 seconds

* Current Software Version will be displayed.

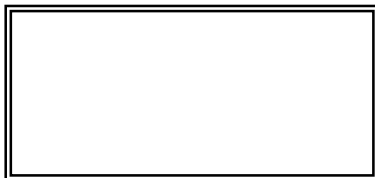

Blank for 3 seconds

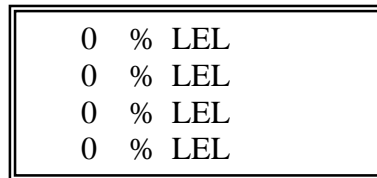

Active Default Gas Concentrations

All channels are inhibited for 65 seconds at power up, this includes all alarm LEDs, and relays. The channel status LEDs flash yellow and green while in the inhibit mode. After the 65 seconds times out the alarm LEDs and relays become active. The channel status LEDs turns to a solid green. If an alarm condition exists at this time, the alarm relays will change state and the internal horn will sound. Push the silence pushbutton, to silence the horn. Relay contact wiring should not be connected at this time, therefore any external devices will not be effected.

The function switches shown below are used to program the instrument.

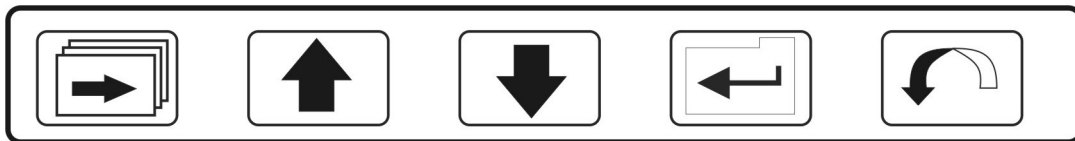

SETUP: This key is used to enter into the programming mode. It is also used to move one position to the right in the programming of an alpha/numeric string.

UP/DOWN: These keys are used to change a value in an alpha/numeric string or to step through the various menus or menu options.

ENTER: This key is used to enter in a particular menu to use the UP/DOWN keys. The ENTER key also accepts a value and steps you back out of the programming of that particular menu.

ESCAPE: This key is used to step back one menu level. Pressing the ESCAPE key repeatedly will eventually take you out of the programming mode and allow you to save (or not save) the programming.

SILENCE/RESET: This key is used to silence the local horn as well as deactivate the horn relay. It also resets any latched relays and causes flashing fault, warn or alarm LEDs to go to steady state. Finally, in the programming of an alpha/numeric string, this key will delete a character. The only exception is the very first character in the string.

Programming Setup

The following Default Display is the starting point for the initial system programming

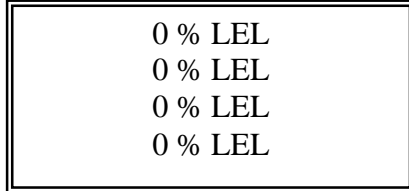

Press the **SETUP** button to proceed.

The following Display is shown for 2 seconds.

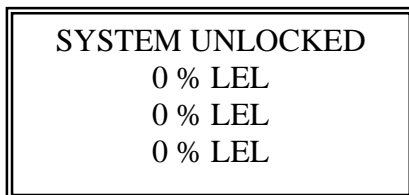

After the 2 seconds have timed out, the following Display is shown. NOTE: The shaded area on the LCD denotes a **Flashing Display** that requires **Action**.

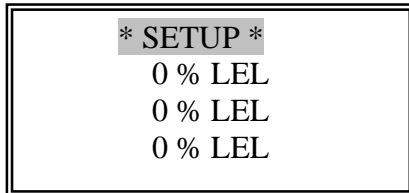

Push the **UP** or **DOWN** button to scroll through each channel. Press the **DOWN** button.

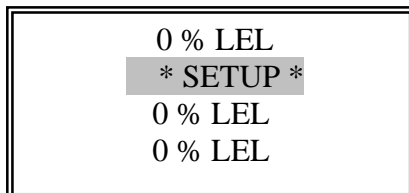

Press the **DOWN** button.

Press the **DOWN** button.

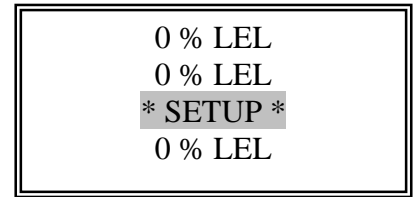

Press the **DOWN** button to return to

Channel 1 * SETUP *

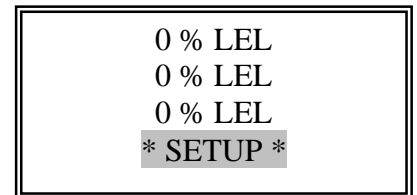

Channel 1 will be used for all programming sequences, all other channels are programmed in the same manner.

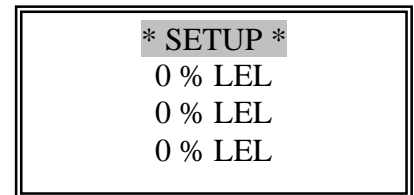

Press **ENTER** to move to the programming menus.

SECURITY MENU

After pressing **ENTER**, the following Display appears.

Note: Channel is now in the Inhibit mode.

LED is flashing yellow and green.

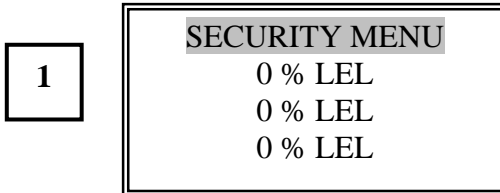

Press the **UP** or **DOWN** button to scroll through each function. Press the **DOWN** button.

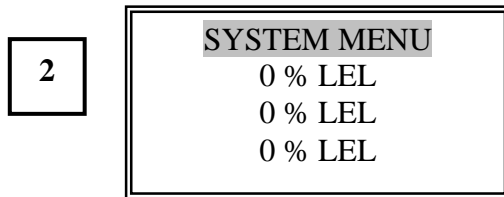

Press the **DOWN** button.

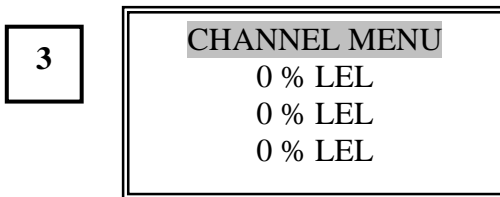

NOTE: From any programming point or function within the **SECURITY MENU**, **SYSTEM MENU** or **CHANNEL MENU**, you can revert back to the **Active Channel Display** by pressing **ESCAPE**.

Pressing the **ESCAPE** button always reverts to the previous menu, therefore, you may need to select **ESCAPE** a number of times to reach the **Active Channel Display**.

The **ESCAPE** mode provides an easy means to revert to a previous function to make changes without losing all previous programming selections

Press the **DOWN** button.

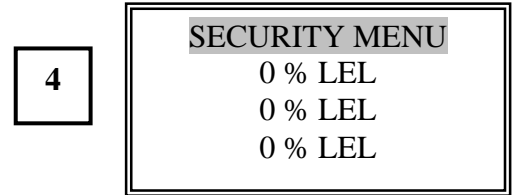

Press the **ENTER** button.

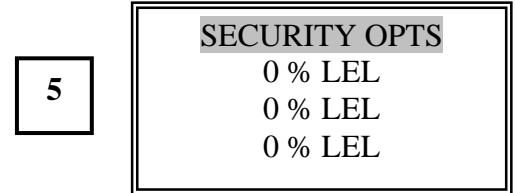

Press the **UP** or **DOWN** button to scroll through each function. Press the **DOWN** button.

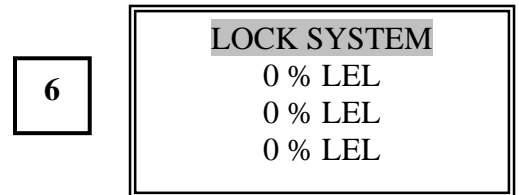

Press the **DOWN** button.

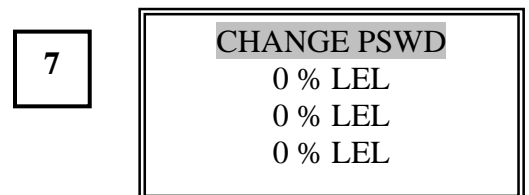

Press the **DOWN** button.

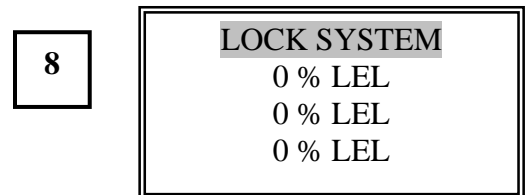

Press the **ENTER** button.

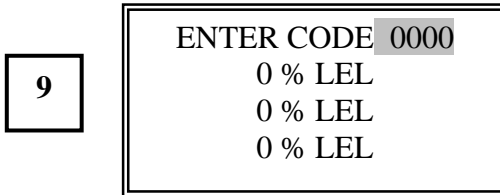

Press the **UP** or **DOWN** button to scroll through numbers from **0000 to 9999** to

select a code number. If you press **ENTER** with a code 0000 displayed, the unit will report NOT ACCEPTED and place you back in the Security OPTS menu. A number from 0001-9999 must be entered if you wish to lock the system. **Remember this number for later use.** If you forget your password, contact the factory.

Press the **UP** button.

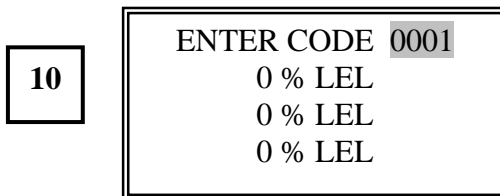

Press the **ENTER** button. This display is shown for 2 seconds.

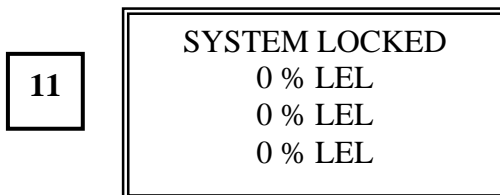

After the 2 seconds have timed out, this display is shown.

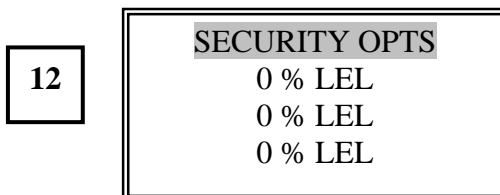

Push the **UP** or **DOWN** buttons to scroll through the menu. Push the **UP** button.

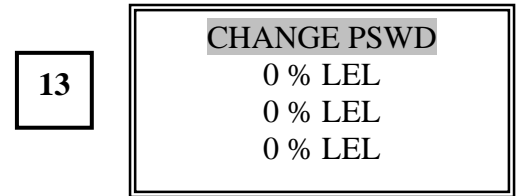

To change the **PASSWORD**, press the **ENTER** button.

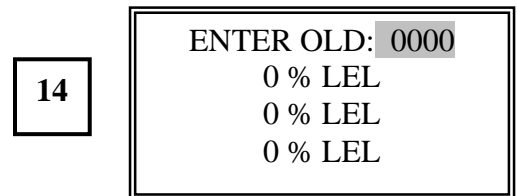

Push the **UP** or **DOWN** buttons to select your old number. Press the **DOWN** button, 9999 is displayed which is an incorrect number.

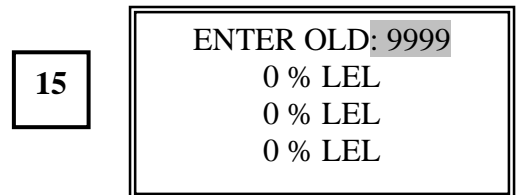

Press the **ENTER** button. This display is shown for 2 seconds.

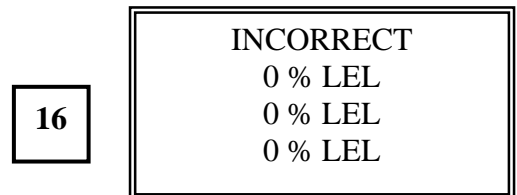

After the 2 seconds have timed out, this display is shown.

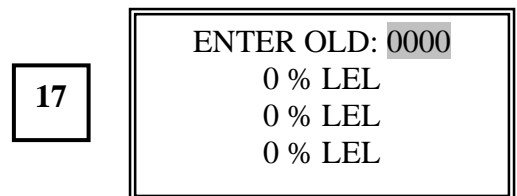

Press the **UP** button and 0001 is displayed.

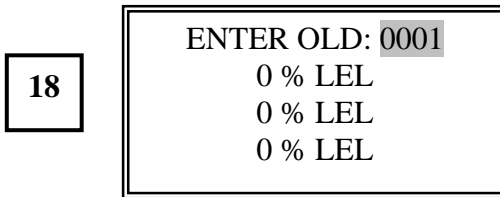

Press the **ENTER** button. This display is shown for 2 seconds.

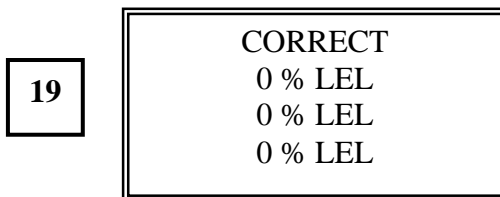

After the 2 seconds have timed out, this display is shown.

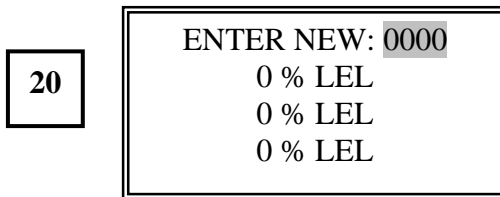

Press the **UP** button and 0001 will appear.

Press the **ENTER** button.

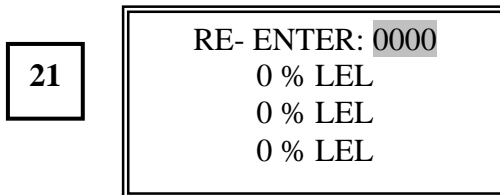

Press the **UP** button again 0001 will appear.

Press the **ENTER** button. This display is shown for 2 seconds.

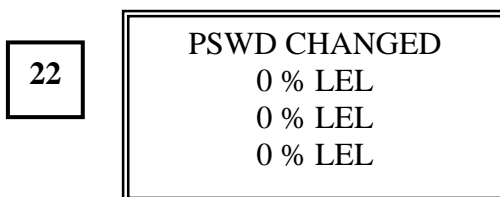

After the 2 seconds have timed out, this display is shown.

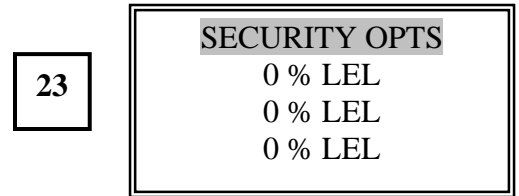

Press **UP** or **DOWN** buttons to scroll the **SECURITY OPTS MENU**. Press the **UP** button.

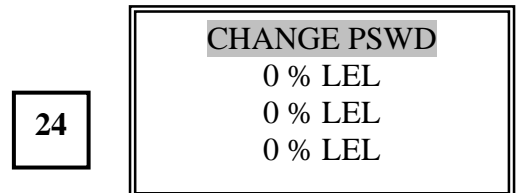

Press the **UP** button.

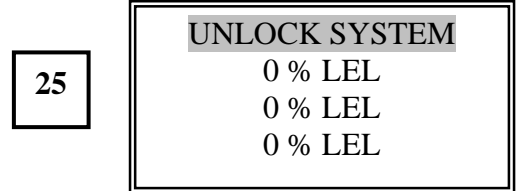

Press the **ENTER** button.

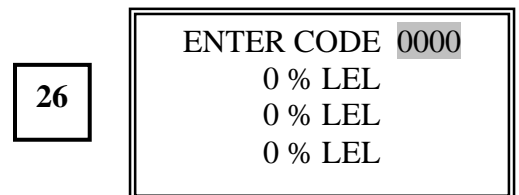

Press the **UP** button.

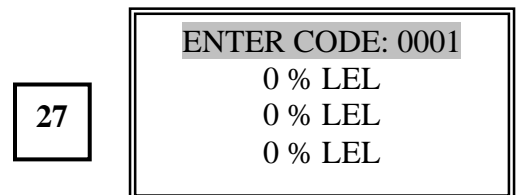

Press the **ENTER** button. This display is shown for 2 seconds

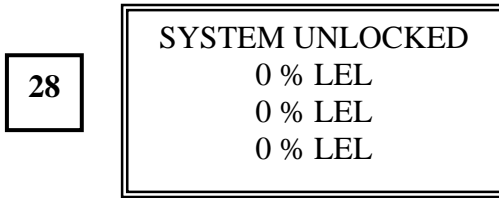

After the 2 seconds have timed out, this display is shown.

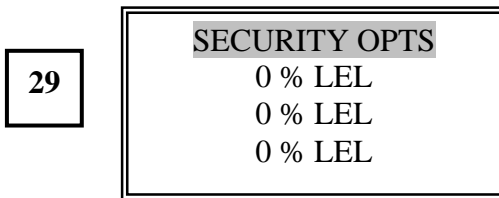

Press the **ESCAPE** button.

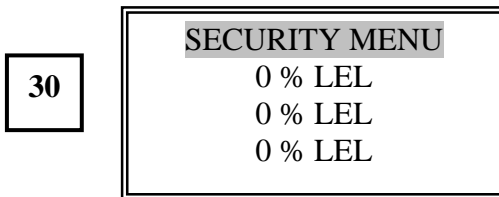

This concludes the **SECURITY MENU** programming.

CAUTION

The System must be **UNLOCKED** when programming the instrument. If the instrument is locked during the programming sequence all programming will be lost a saving will not be permitted.

Press the **DOWN** button.

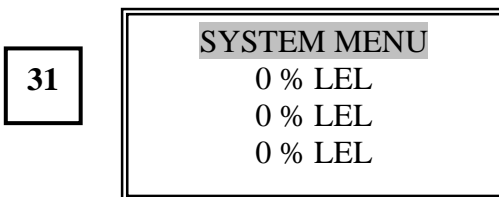

This is the starting point for programming the **SYSTEM MENU**.

Go to the SYSTEM MENU SECTION.

SYSTEM MENU

The System Menu programs those settings common to the whole unit and not for individual channel inputs.

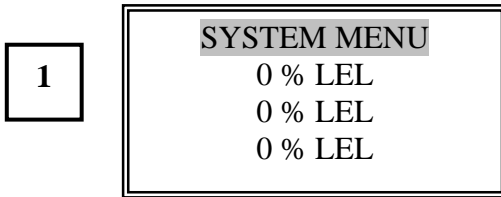

Press the **ENTER** button.

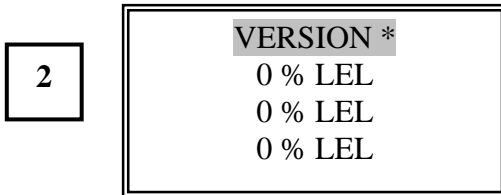

Press the **UP** button.

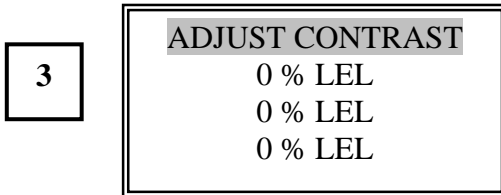

Press the **ENTER** button. Channel 1 Display stops flashing. Press and hold either the **UP** or **DOWN** buttons to adjust the contrast for your specific location.

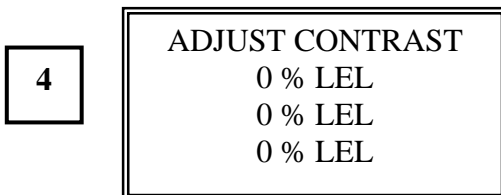

Press the **ENTER** button.

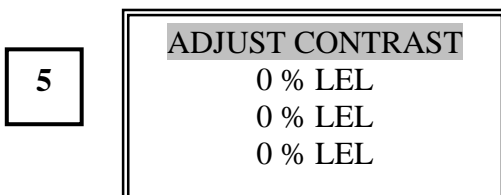

Press the **UP** button.

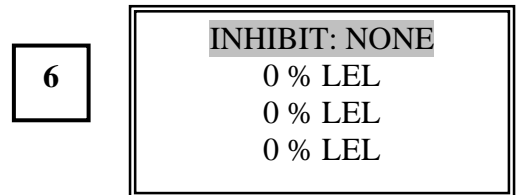

Press the **ENTER** button.

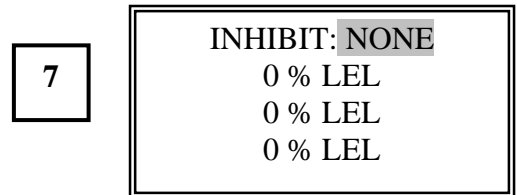

Push the **UP** or **DOWN** buttons to scroll through two choices: **ALL** or **NONE**. Press the **UP** button.

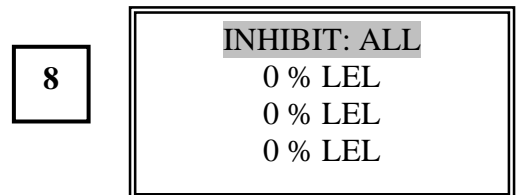

Press the **ENTER** button.

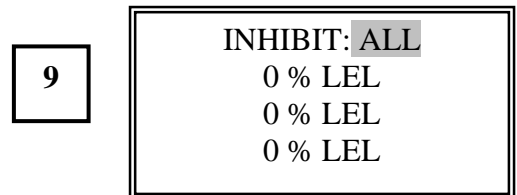

Press the **ENTER** button

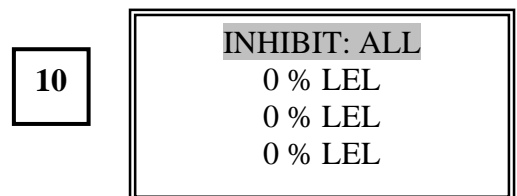

* **Current Software Version will be displayed.**

NOTE: All alarm relays and alarm LEDs will be inhibited when the programming sequence is returned to the active channel display. In addition, the analog 4-20mA output is set to the programmed inhibit level. This selection would allow you to wire all external alarms or shutdown devices without concern of false alarms.

To change back to the **NONE INHIBIT MODE**, press the **ENTER** button

11

INHIBIT: ALL
0 % LEL
0 % LEL
0 % LEL

Press the **UP** button.

12

INHIBIT: NONE
0 % LEL
0 % LEL
0 % LEL

Press the **ENTER** button.

13

INHIBIT: NONE
0 % LEL
0 % LEL
0 % LEL

Press the **UP** button.

14

SET LOCAL RELAYS
0 % LEL
0 % LEL
0 % LEL

Press the **ENTER** button.

15

RELAY: CMN FAIL
0 % LEL
0 % LEL
0 % LEL

Press the **ENTER** button.

16

FAILSAFE: YES
0 % LEL
0 % LEL
0 % LEL

The **FAIL RELAY** cannot be programmed to other modes. Press the **ENTER** button.

17

F1 F2 F3 F4
0 % LEL
0 % LEL
0 % LEL

The common fault relay is factory set to activate if any channel detects a fault. Press the **ENTER** button.

18

RELAY: CMN FAIL
0 % LEL
0 % LEL
0 % LEL

Press the **UP** button.

19

RELAY: CMN WARN
0 % LEL
0 % LEL
0 % LEL

Press the **ENTER** button.

20	FAILSAFE: NO
	0 % LEL
	0 % LEL
	0 % LEL

Press the **UP** or **DOWN** buttons to scroll through the menu, **NO** or **YES**. For example, select **YES**. Press the **UP** button.

21	FAILSAFE: YES
	0 % LEL
	0 % LEL
	0 % LEL

“FAILSAFE: YES” configures the relay to be normally energized. This is energized in a non-alarm state. Press the **ENTER** button.

22	W1 W2 W3 W4
	0 % LEL
	0 % LEL
	0 % LEL

W1 | W2 | W3 | W4 is the factory default setting for the common Warn relay. It indicated if the Warn level is reached on any channel (1-4), then the common warn relay will activate. “|” indicates and “OR” logic. The warn relay can be user programmed to operate with any channel or group of channels. In addition AND/OR logic can be configured. Finally, the relay can be programmed to activate off the Warn or Alarm setpoint. See the programming examples in the Appendix for additional information.

Press the **ENTER** button.

23	RELAY: CMN WARN
	0 % LEL
	0 % LEL
	0 % LEL

Press the **UP** button.

24	RELAY: CMN ALARM
	0 % LEL
	0 % LEL
	0 % LEL

Press the **ENTER** button.

25	FAILSAFE: NO
	0 % LEL
	0 % LEL
	0 % LEL

Press the **UP** or **DOWN** buttons to scroll through the menu, **NO** or **YES**, for example select **YES**. Press the **UP** button.

26	FAILSAFE: YES
	0 % LEL
	0 % LEL
	0 % LEL

Press the **ENTER** button.

27	A1 A2 A3 A4
	0 % LEL
	0 % LEL
	0 % LEL

A1 | A2 | A3 | A4 is the factory default setting for the common Alarm relay. It indicates if the Alarm level is reached on any channel (1-4), then the common alarm

relay will activate. The “|” indicates an “OR” logic. Like the warn relay, the alarm relay can be configured to activate off any channel and with AND/OR logic. See the programming examples in the Appendix.

Press the **ENTER** button.

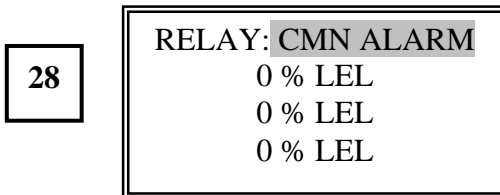

Press the **ESCAPE** button.

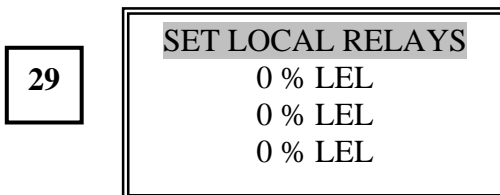

Press the **UP** button.

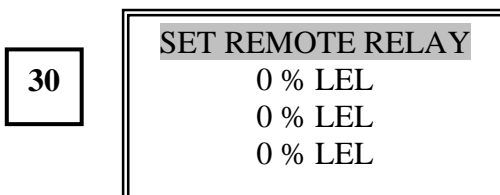

This programming mode will be passed at this time.

If a REMOTE RELAY ASS'Y has been provided with the Receiver/Controller. Refer to Optional Remote Relay.

Press the **UP** button.

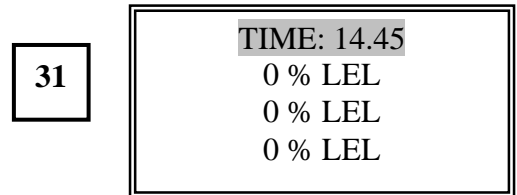

Press the **ENTER** button.

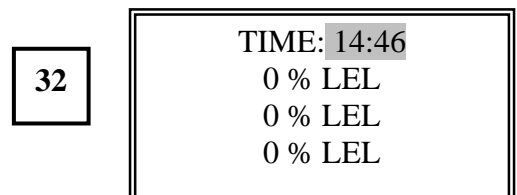

Press the **UP** or **DOWN** buttons to select the correct time. Press the **ENTER** button.

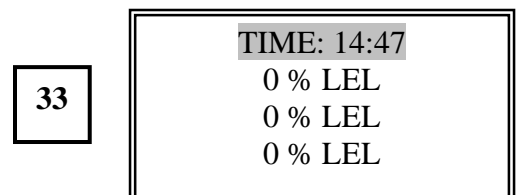

Press the **UP** button.

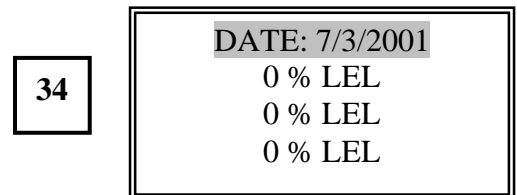

Press the **ENTER** button.

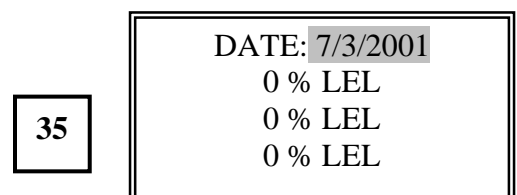

Press the **UP** or **DOWN** buttons to select the correct Month, Day and Year.

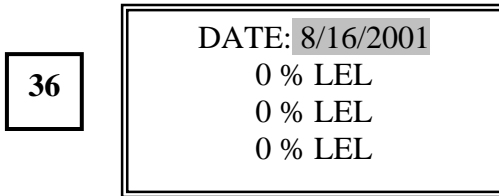

Press the **ENTER** button.

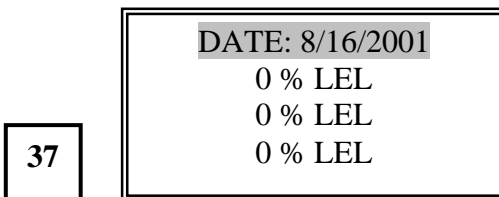

Press the **UP** button.

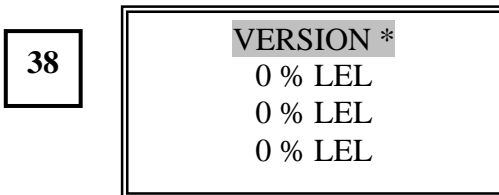

Press the **ESCAPE** button.

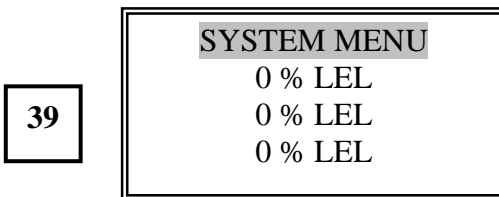

Press the **DOWN** button.

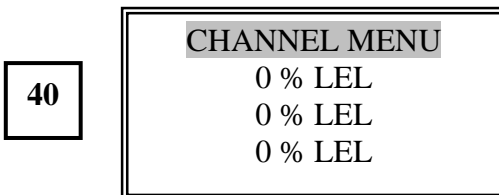

This is the starting point to start programming the **CHANNEL MENU**

Go to the **CHANNEL MENU SECTION**.

***Current Software Version will be displayed.**

CHANNEL MENU

The Channel Menu programs those settings specific to an individual channel.

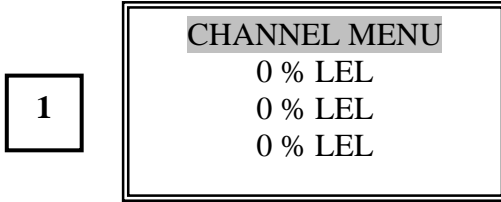

Press the **ENTER** button.

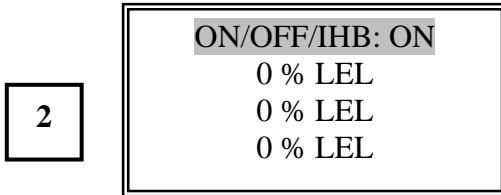

Press the **ENTER** button.

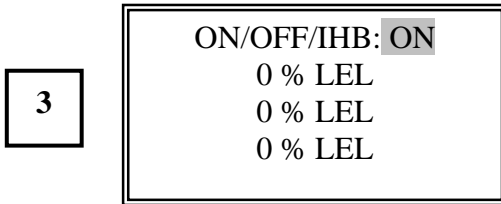

Press the **UP** or **DOWN** buttons to scroll the menu.

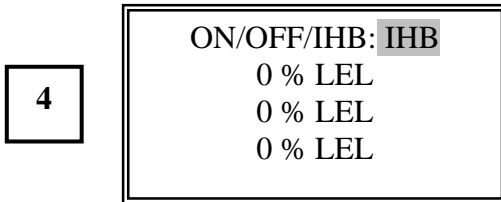

Press the **ENTER** button.

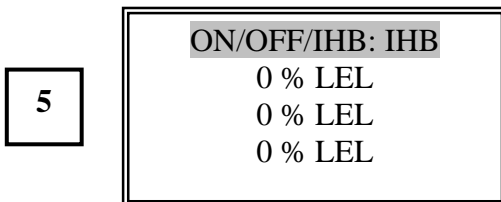

The analog output (4-20mA) will be set to the programming inhibit level. No relay contacts will activate from Channel 1. (Channel 1 was used in this example.)

To select **OFF**, press the **ENTER** button

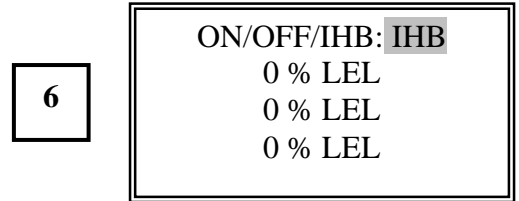

Press the **UP** button.

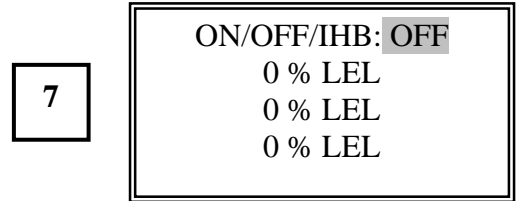

Press the **ENTER** button.

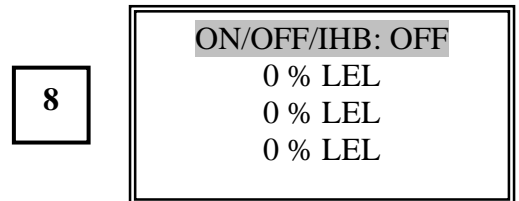

Turning a channel **OFF** drives the analog signal (4-20mA) to the programming inhibit level. No relay contacts will activate from this channel.

To select the factory default "**ON**", press the **ENTER** button and toggle the **UP** button until **ON** is displayed. Press the **ENTER** button.

9

ON/OFF/IHB: OFF
0 % LEL
0 % LEL
0 % LEL

Press the **UP** button.

10

ON/OFF/IHB: ON
0 % LEL
0 % LEL
0 % LEL

Press the **UP** button.

11

SENSOR: 4 – 20 mA
0 % LEL
0 % LEL
0 % LEL

This setting cannot be changed.

Press the **UP** button.

12

FULL SCALE: 100
0 % LEL
0 % LEL
0 % LEL

Press the **ENTER** button.

13

FULL SCALE: 100
0 % LEL
0 % LEL
0 % LEL

Press the **UP** or **DOWN** buttons to scroll through the **FULL SCALE RANGES**

1.00 to 10.00

10.0 to 100.0

100 to 1999

Select the **FULL SCALE** required. For example, use **50.0**

14

FULL SCALE: 50.0
0 % LEL
0 % LEL
0 % LEL

Press the **ENTER** button.

15

FULL SCALE: 50.0
0 % LEL
0 % LEL
0 % LEL

Press the **UP** button.

16

UNITS: %
0 % LEL
0 % LEL
0 % LEL

Press the **ENTER** button.

17

UNITS: %
0 % LEL
0 % LEL
0 % LEL

Press the **UP** or **DOWN** buttons to scroll the **UNITS: NONE, PPB, PPM or %.**

Note: If less than 4 Channels active, **NONE** would be selected for the inactive Channels. For example, use **PPM**. Press the **DOWN** button.

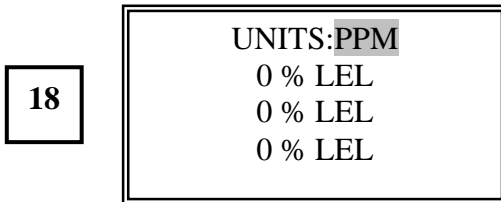

Press the **ENTER** button

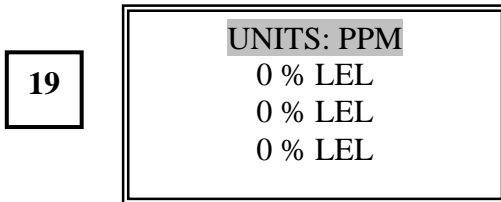

Press the **UP** button.

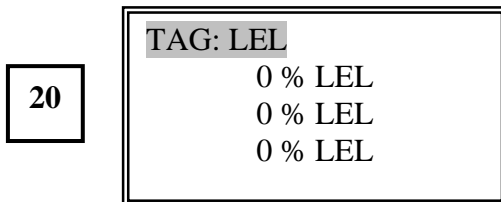

Press the **ENTER** button.

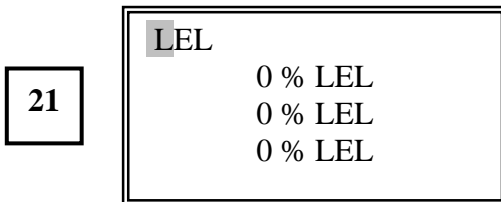

NOTE: A **TAG** can list up to 6 Letters, Symbols or Numbers in any combination.

A - Z, ! " # \$ % & ' () * +
, - . / 0 - 9 : ; < = > ? xx

To move from the #1 position to the right to #2 position, press the **SETUP** button.

Each time you press the **SETUP** button, you move 1 position to the right until you reach #6 position and then you revert back to #1 position.

Use the **UP/DOWN** button to change characters. When you have selected the required **TAG**, press the **DOWN** button. For this example use **H2S** and select **H**

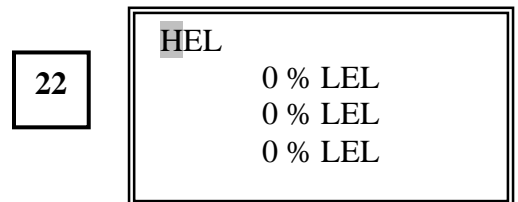

Press the **SETUP** button.

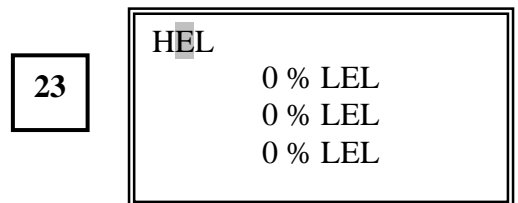

Press the **DOWN** button to select **2**.

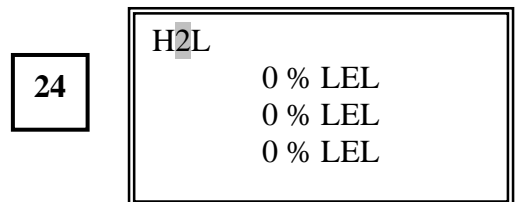

Press the **SETUP** button.

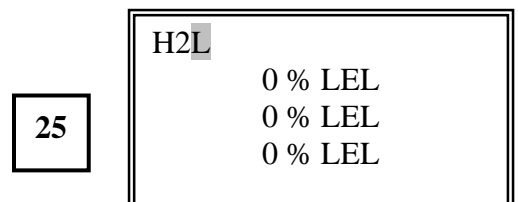

Press **UP** button to select **S**

26

TAG: H2S

0 % LEL

0 % LEL

0 % LEL

Press the **UP** button.

27

DAMPING (S): 2

0 % LEL

0 % LEL

0 % LEL

Press the **ENTER** button.

28

DAMPING (S): 2

0 % LEL

0 % LEL

0 % LEL

Press the **UP** or **DOWN** buttons to select from **0 to 10**. For this example, select 3. Press the **UP** button

29

DAMPING (S): 3

0 % LEL

0 % LEL

0 % LEL

Press the

30

DAMPING (S): 3

0 % LEL

0 % LEL

0 % LEL

Press the **UP** button.

31

ZERO DB (%FS): 0

0 % LEL

0 % LEL

0 % LEL

Press the **ENTER** button.

32

ZERO DB (%FS): 0

0 % LEL

0 % LEL

0 % LEL

Press the **UP** or **DOWN** buttons to select from **0 to 5**. For this example, select **2**.

Press the **UP** button.

33

ZERO DB (%FS): 2

0 % LEL

0 % LEL

0 % LEL

Press the **ENTER** button.

34

ZERO DB (%FS): 2

0 % LEL

0 % LEL

0 % LEL

Press the **UP** button.

35

INHIBIT (mA): 3.6
0 % LEL
0 % LEL
0 % LEL

Press the **ENTER** button.

36

INHIBIT (mA): 3.6
0 % LEL
0 % LEL
0 % LEL

Press the **UP** or **DOWN** buttons to select from **2.0 to 20.0**. For this example, select **2.5**.

Press the **DOWN** button.

37

INHIBIT (mA): 2.5
0 % LEL
0 % LEL
0 % LEL

Press the **ENTER** button.

38

INHIBIT (mA): 2.5
0 % LEL
0 % LEL
0 % LEL

Press the **UP** button.

39

FAULT (mA): 3.6
0 % LEL
0 % LEL
0 % LEL

Press the **ENTER** button.

40

FAULT (mA) 1.0
0 % LEL
0 % LEL
0 % LEL

Press the **UP** or **DOWN** buttons to select from **0.1 to 20.0**. For this example, select **2.0**.

Press the **UP** button

41

FAULT (mA): 2.0
0 % LEL
0 % LEL
0 % LEL

Press the **ENTER** button.

42

FAULT (mA): 2.0
0 % LEL
0 % LEL
0 % LEL

Press the **UP** button.

43

SETUP WARNING
0 % LEL
0 % LEL
0 % LEL

Press the **ENTER** button.

44

WARN SET: 25
0 % LEL
0 % LEL
0 % LEL

Press the **ENTER** button.

45	WARN SET: 25 0 % LEL 0 % LEL 0 % LEL
-----------	--

Press the **UP** or **DOWN** buttons to select from **1 to 120**. For this example, select **22**.

Press the **DOWN** button. **NOTE: LEL applications should never set an alarm level above 60% LEL.**

46	WARN SET: 22 0 % LEL 0 % LEL 0 % LEL
-----------	--

Press the **ENTER** button.

47	WARN SET: 22 0 % LEL 0 % LEL 0 % LEL
-----------	--

Press the **UP** button.

48	WARN RES: 20 0 % LEL 0 % LEL 0 % LEL
-----------	--

Press the **ENTER** button.

49	WARN RES: 20 0 % LEL 0 % LEL 0 % LEL
-----------	--

Press the **UP** or **DOWN** buttons to select from **1 to 120**. For this example, select **18**. Press the **DOWN** button.

For rising gas alarms, set the reset value below the **WARN** value as in this example. For falling gas alarms (oxygen deficiency), set the reset value above the **WARN** value.

50	WARN RES: 18 0 % LEL 0 % LEL 0 % LEL
-----------	--

Press the **ENTER** button.

51	WARN SET: 18 0 % LEL 0 % LEL 0 % LEL
-----------	--

Press the **UP** button.

52	WARN DLY: 0 0 % LEL 0 % LEL 0 % LEL
-----------	---

Press the **ENTER** button.

53

WARN DLY: 0
0 % LEL
0 % LEL
0 % LEL

Press the **UP** or **DOWN** buttons to select from **0 to 10** seconds. For this example, select **2**. Press the **UP** button.

54

WARN DLY: 2
0 % LEL
0 % LEL
0 % LEL

Press the **ENTER** button.

55

WARN DLY: 2
0 % LEL
0 % LEL
0 % LEL

Press the **UP** button.

56

WARN HLD: 0
0 % LEL
0 % LEL
0 % LEL

Press the **ENTER** button.

57

WARN HLD: 0
0 % LEL
0 % LEL
0 % LEL

Press the **UP** or **DOWN** buttons to select from **0 to 7200**. For this example, select **150**. Press the **UP** button.

58

WARN HLD: 150
0 % LEL
0 % LEL
0 % LEL

Press the **ENTER** button.

59

WARN HLD: 150
0 % LEL
0 % LEL
0 % LEL

Press the **UP** button.

60

WARN LAT: NO
0 % LEL
0 % LEL
0 % LEL

Press the **ENTER** button.

61

WARN LAT: NO
0 % LEL
0 % LEL
0 % LEL

Press the **UP** or **DOWN** buttons to select **YES**.
Press the **UP** button.

62

WARN LAT: YES
0 % LEL
0 % LEL
0 % LEL

Press the **ENTER** button.

63

WARN LAT: YES
0 % LEL
0 % LEL
0 % LEL

Press the **ESCAPE** button.

64

SETUP WARNING
0 % LEL
0 % LEL
0 % LEL

Press the **UP** button.

65

SETUP ALARM
0 % LEL
0 % LEL
0 % LEL

Press the **ENTER** button.

66

ALARM SET: 50
0 % LEL
0 % LEL
0 % LEL

Press the **ENTER** button.

67

ALARM SET: 50
0 % LEL
0 % LEL
0 % LEL

Press the **UP** or **DOWN** buttons to select from **1** to **120**. For this example, select **52**. Press the **UP** button. **NOTE: LEL applications should never set an alarm level above 60% LEL.**

68

ALARM SET: 52
0 % LEL
0 % LEL
0 % LEL

Press the **ENTER** button.

69

ALARM SET: 52
0 % LEL
0 % LEL
0 % LEL

Press the **UP** button.

70

ALARM RES:45
0 % LEL
0 % LEL
0 % LEL

Press the **ENTER** button.

71

ALARM RES: 45
0 % LEL
0 % LEL
0 % LEL

Press the **UP** or **DOWN** buttons to select from **1 to 120**. For this example, select **42**.

Press the **DOWN** button.

For rising gas alarms, set the reset value below the **WARN** value, as in this example.
For falling gas alarms (oxygen efficiency), set the reset value above the **WARN** value

72

ALARM RES: 42
0 % LEL
0 % LEL
0 % LEL

Press the **ENTER** button.

73

ALARM RES: 42
0 % LEL
0 % LEL
0 % LEL

Press the **UP** button.

74

ALARM DLY: 0
0 % LEL
0 % LEL
0 % LEL

Press the **ENTER** button.

75

ALARM DLY: 0
0 % LEL
0 % LEL
0 % LEL

Press the **UP** or **DOWN** buttons to select from **0 to 10** seconds. For this example, select **5**.
Press the **UP** button.

76

ALARM DLY: 5
0 % LEL
0 % LEL
0 % LEL

Press the **ENTER** button.

77

ALARM DLY: 5
0 % LEL
0 % LEL
0 % LEL

Press the **UP** button.

78

ALARM HLD: 0
0 % LEL
0 % LEL
0 % LEL

Press the **ENTER** button.

79

ALARM HLD: 0
0 % LEL
0 % LEL
0 % LEL

Press the **UP** or **DOWN** buttons to select from **0 to 7200**. For this example select **100**.
Press the **UP** button.

80 ALARM HLD: **100**
0 % LEL
0 % LEL
0 % LEL

Press the **ENTER** button.

81 ALARM HLD: **100**
0 % LEL
0 % LEL
0 % LEL

Press the **UP** button.

82 ALARM LAT: **NO**
0 % LEL
0 % LEL
0 % LEL

Press the **ENTER** button.

83 ALARM LAT: **NO**
0 % LEL
0 % LEL
0 % LEL

Press the **UP** or **DOWN** buttons to select **YES**.
Press the **UP** button.

84 ALARM LAT: **YES**
0 % LEL
0 % LEL
0 % LEL

Press the **ENTER** button.

85 ALARM LAT: **YES**
0 % LEL
0 % LEL
0 % LEL

Press the **ESCAPE** button.

86 SETUP ALARM
0 % LEL
0 % LEL
0 % LEL

Press the **UP** button.

87 CAL LOOP INPUT
0 % LEL
0 % LEL
0 % LEL

Press the **ENTER** button.

NOTE: The following message scrolls on the Channel 1 display area

Input 4 mA at TB1 6,7

88 SCROLL
0 % LEL
0 % LEL
0 % LEL

Press the **ENTER** button. This display appears for 3 seconds.

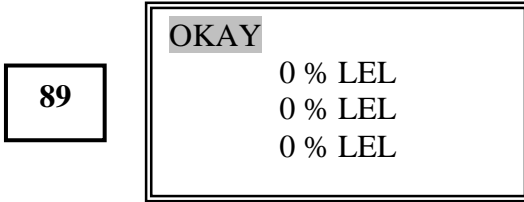

After the time out, the following scrolls on the Channel 1 display area **Inp. 20mA at TB1 6,7.**

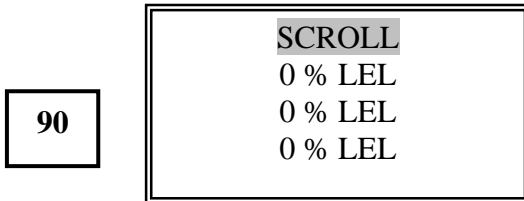

Note: Channels 2, 3, and 4 have different **TB1** and **TB2** designations.

Press the **ESCAPE** button.

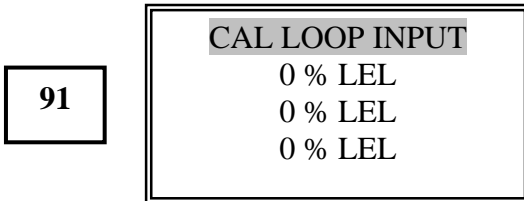

Press the **UP** button.

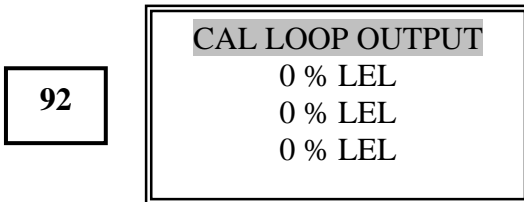

Press the **ENTER** button.

NOTE: The following message scrolls on the Channel 1 display area **MA out = TB 5 3, 4.**

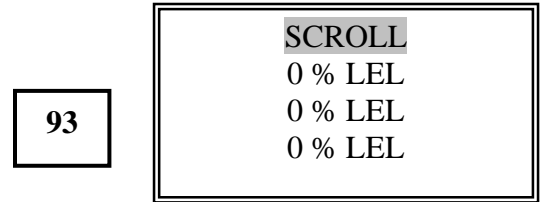

Note: Channels 2, 3, and 4 have different **TB5** designations.

Press the **ENTER** button.

NOTE: The following message scrolls on the Channel 1 display area.

Use **UP/DN: Adjust to 4.00 mA**

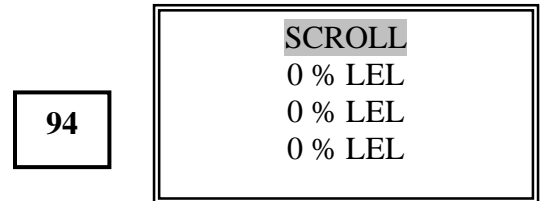

Press the **ENTER** button.

NOTE: The following message scrolls on the Channel 1 display area.

Use **UP/DN: Adjust to 20.00 mA.**

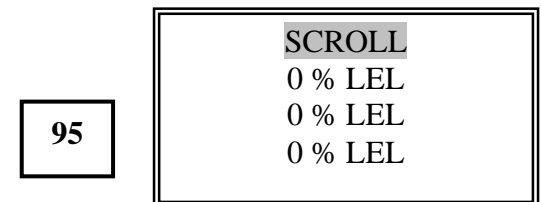

Press the **ENTER** button.

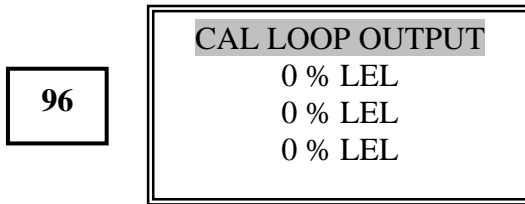

Press the **ESCAPE** button.

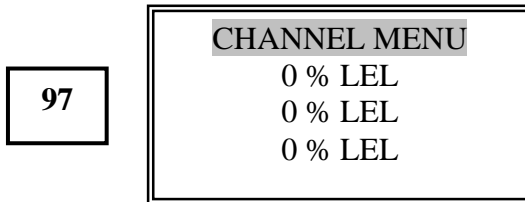

Press the **ESCAPE** button.

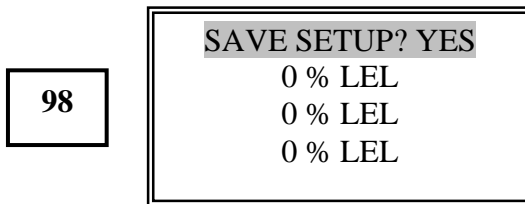

For this example select **YES**. Press the **ENTER** button. This display is shown for 2 seconds.

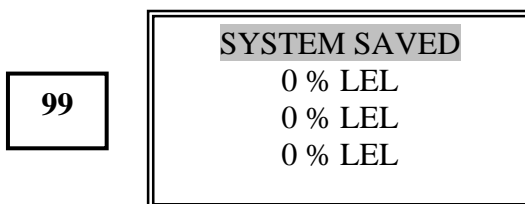

After the time out period, the display reverts to the default display.

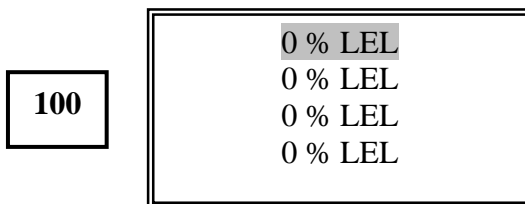

NOTE: At this point all ALARMS are active.

Press the **ENTER** button.

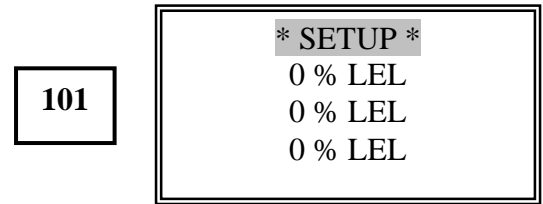

Press the **DOWN** button. This is the start to program **Channel 2**.

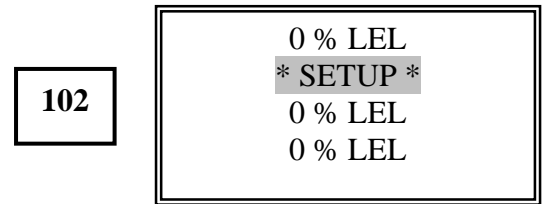

All Channels are programmed in the same manner as Channel 1.

When the programming is completed for all active channels, the following can be implemented.

At this time if you wish to setup a **SECURITY CODE**, refer to the Security Menu.

Wiring can now be completed to all external alarm and/or shutdown devices.

When the wiring is completed, refer to The Inhibit section in the System Menu to remove the **INHIBIT** from all channels, if the inhibit LCD is flashing.

Optional Remote Relays

General

The optional remote relay assembly offers a unique alarm system for all alarms generated from the QuadScan II, which include warn, alarm and fail. Warn refers to the first level of alarming while alarm refers to the second level (more serious) of alarming. The unit inputs the alarm signals, which can be programmed to provide a variety of relay configurations to change the state of the 8 relays, when an alarm condition exists. A terminal strip provides the interface between the relay contacts and the customer shut down or corrective devices. All the relay configurations are programmed from the display/function assembly. Be sure to consider the additional current requirements for all optional when evaluating backup power sources.

Specific

The QuadScan II remote relay assembly (P/N 096-2691) has 3 major components:

- NEMA-4X enclosure
- Circuit board
- Interface cable

NEMA-4X Enclosure

The enclosure measures 4-3/4" H x 6-23/32 " W x 3-3/16 "D. It provides a watertight, dust tight and corrosive resistant enclosure for indoor or outdoor mounting.

Circuit Board

The circuit board (P/N 096-2688) provides terminal blocks and 6 – SPST relays and 2 – DPDT relays. The 7400 provides the power required to switch the relays. The circuit board, relays and terminal blocks can be reached by removing 4 inset Phillips head screws from the cover and it lifting off. TB 9 provides the terminal interface between the remote relay assembly and the QuadScan II.

Terminals 1 – 4	Signal inputs.
5	Ground
6	+ Volts

TB 10 provides the terminal interface between the remote relay assembly and the required customer shutdown or corrective action devices. Enclosure orientation for the terminal strip and relay description is

with the cable or conduit entry at the bottom of the enclosure. TB 10 terminals number from 1 to 30 from left to right and provide NC, C and NO relay contacts. Relays are numbered 1 to 8 from right to left.

Cable

Ten feet of 6 conductor (24AWG) wire (P/N 069-0065) is supplied standard with the relay assembly (P/N 069-2651). Additional cable may be ordered separately. A maximum of 50 feet of cable can be used between the remote relay and the 7400.

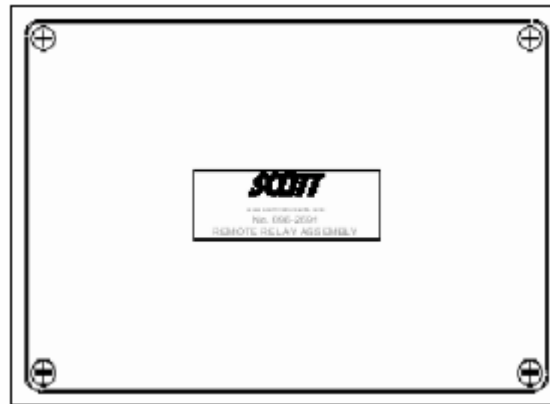

Figure 11 - Remote Relay Enclosure – Front View

Installation

Location

The location of the remote relay assembly has the same requirements as the QuadScan II. Refer to the Installation section. The unit is mounted in the general area of the QuadScan II with a maximum separation of 50 feet (16 meters). A 10 foot (3 meter) cable is supplied standard with the unit. Note: Other cable lengths are available up to 50 feet. Contact Scott Health & Safety for pricing information.

Mounting

The enclosure dimensions are 4-3/4" H x 6-23/32" W x 3-3/16" D and weighs 1 pound. Refer to [Figure 12](#) for mounting hole locations. Within the cable length, locate the 4 mounting holes at the desired location and drill the holes for the proper screw size. Using #8 screws, mount the enclosure to the wall or other suitable structure.

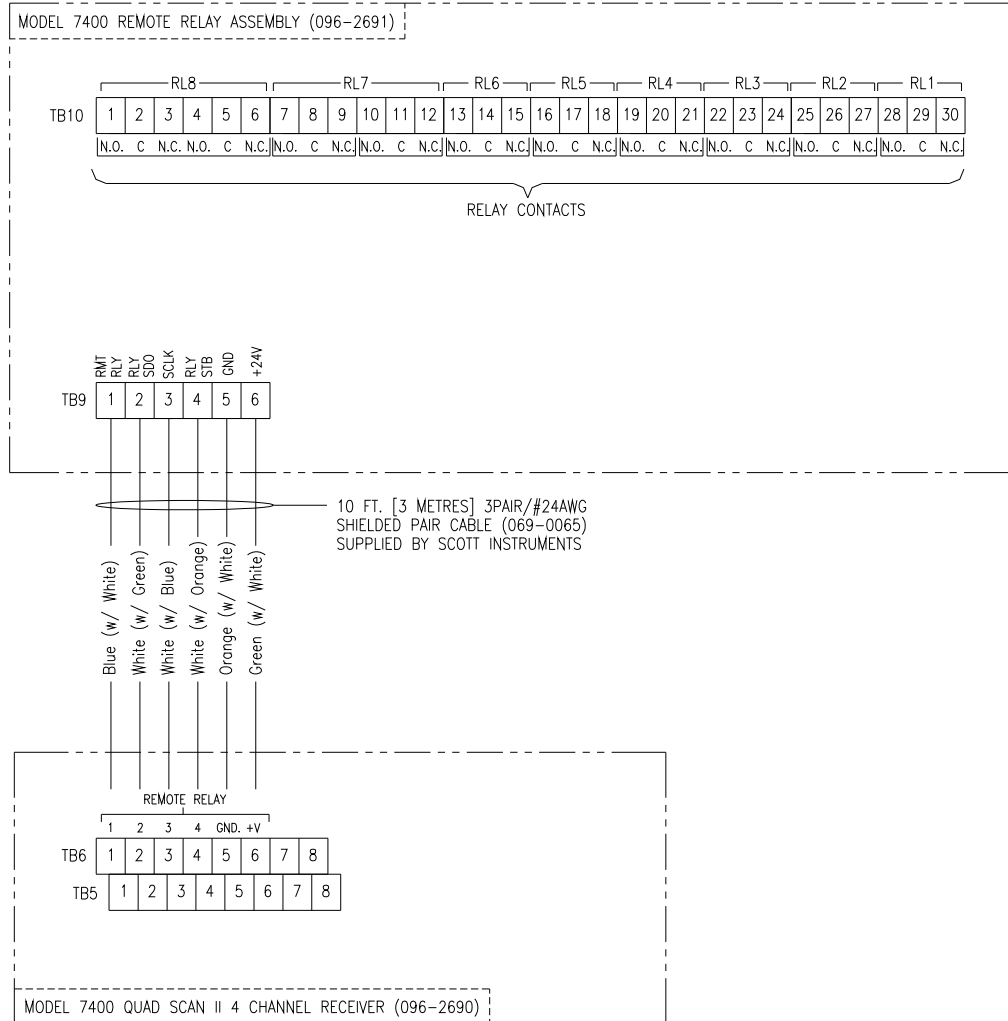

Figure 13 - Interconnect Wiring Between 7400 & Remote Relay Assembly

Remote Relay Operation

The remote relays operate from the alarm signals from the QuadScan II. Each of the 1 through 8 relays can be programmed for various combinations of alarm inputs. The programming allows AND / OR configurations for zone applications as well as many others. Refer to **Figure 14** for the factory default of the remote relay settings.

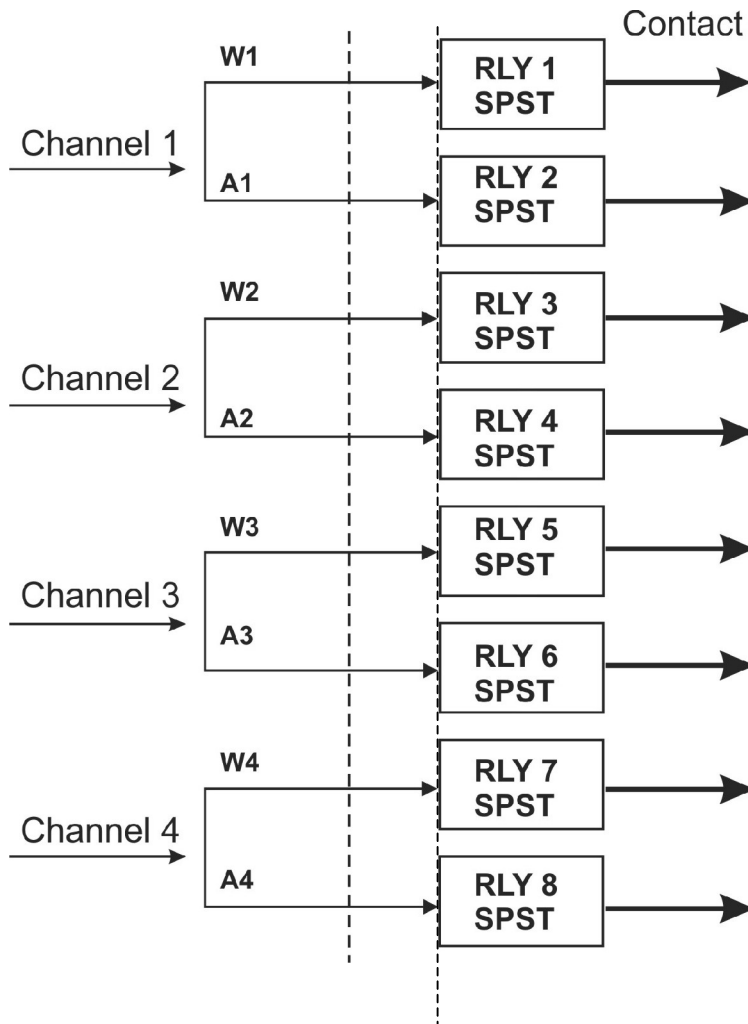

Figure 14 - Remote Relay Settings Factory Default

The remote relays can be programmed to any specific alarm condition and are activated independently from each other. The unit is shipped with factory default settings in place for each relay. The defaults are as follows:

Relay 1 – W1	Relay 2 – A1	Relay 3 – W2
Relay 4 – A2	Relay 5 – W3	Relay 6 – A3
Relay 7 – W4	Relay 8 – A4	

If the default setting is not changed for a specific relay(s), then that relay will be activated when the default alarm condition exists. For example if Relay 1 is programmed to activate when a specific combination of alarms exist and Relays 2 through 8 have not been changed from the default settings then these relays will also be activated if the alarm combination for Relay 1 includes that specific relay or relays.

For the customer to customize a specific relay, that relay must be programmed for the desired customer requirements. The basis for the programming procedure for a specific relay are the alarms warn (W), alarm (A) and fail (F) which are generated within the QuadScan II for each channel when a gas or fail condition is detected on that channel.

The programming functions available for each relay are:

W, A, F, 1, 2, 3, 4, &, |, (,).

The following explains the letters, numbers and symbols.

- W, A, F** Alarm conditions **W**arn (low alarm), **A**larm (high alarm) and **F**ail (input loop open circuit or shorted)
- 1, 2, 3, 4** Refers to the channel number
- &** AND Function: i.e W1 **&** W2
- |** OR Function i.e. W1 **|** W2
- (,)** To separate one group of functions from another group of functions

The following examples explain the various functions.

If RMT RLY 1 is programmed as **W1 & W2**, to change the state of RMT RLY1, warn (W) from Channel 1 must be in alarm **AND** Warn (W) from Channel 2 must be in alarm.

If RMT RLY 3 is programmed as **(A1 & A2) | (W3 & A4)**, to change the state of RMT RLY3, alarm (A) from Channel 1 must be in alarm **AND** alarm (A) from Channel 2 must be in alarm **OR** warn (W) from Channel 3 must be in alarm **AND** alarm (A) from Channel 4 must be in alarm.

Remote Relay Setup and Programming

The following default display is the starting point for programming the Remote Relays.

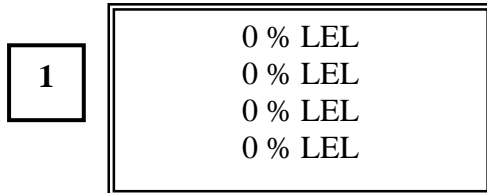

Press the **SETUP** button. This display is shown for 2 seconds.

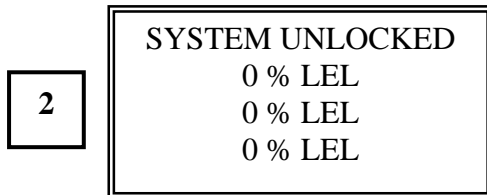

After the 2 seconds timed out, this display is shown.

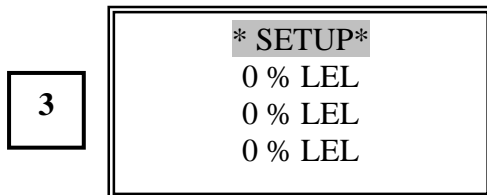

Press the **ENTER** button.

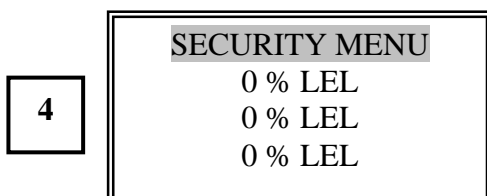

Press the **DOWN** button

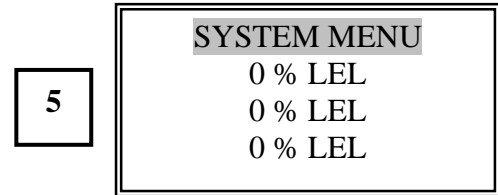

Press the **ENTER** button.

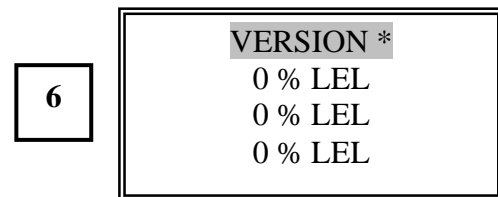

Press the **UP** button to scroll to this display. Note: This menu is only displayed if the remote relay assembly is physically hooked up to the 7400.

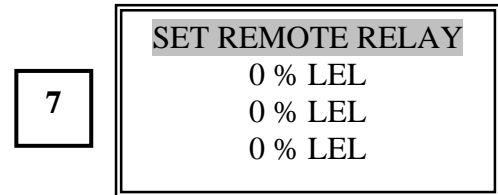

Press the **ENTER** button.

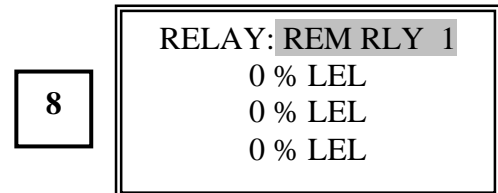

Note: All remaining channels are programmed in the same manner as Channel 1.

Press the **ENTER** button. Note: You can not use the **ESCAPE** button to back out of this submenu. You must press **ENTER**.

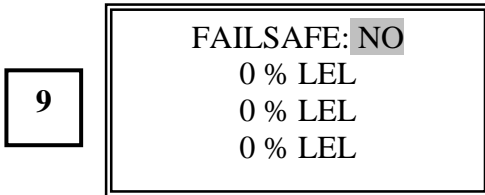

Press the **UP** or **DOWN** button.

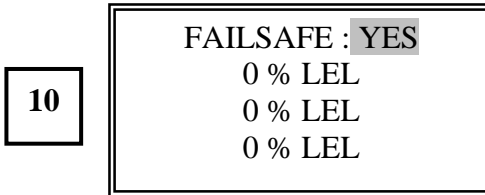

***Current Software Version will be displayed.**

YES can be selected by pressing the **ENTER** button, but for this example the default **NO** will be used.

Press the **UP** or **DOWN** button.

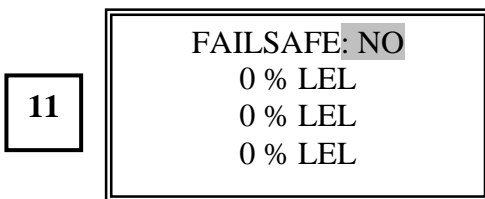

Press the **ENTER** button.

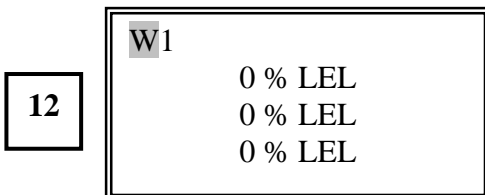

Note 1: To program any relay for specific alarms, the following letters, numbers and symbols are used: **W** (Warn), **A** (Alarm), **F** (Fail), **1,2,3,4**(Channel numbers), **&** (AND), **|** (OR), **(** and **)** (used to separate groups of alarms).

Note2: The LCD can display 16 letters, numbers or symbols out of 32 at one time on the LCD.

Each time the **SETUP** button is

pressed, the program position moves 1 flashing position to the right. The flashing position will wrap around to the first position.

Note3: If a mistake is made during entry of the selection, press the RESET/Silence button to delete a character. Corrections can then be made without using the **ESCAPE** button. Note: The first character in the string cannot be deleted.

If you wish to change the **W** to **A** or **F**, press the **UP** button to select your requirement. For this example, use the Factory Default **W**.

Press the **SETUP** button

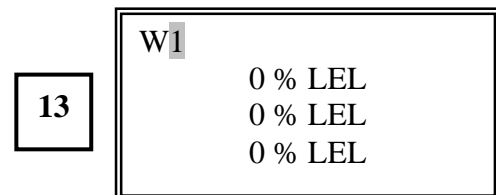

If you wish to change the 1 to another channel number, press the **UP** or **DOWN** button. If you wish to add additional alarms or **AND** and **OR** functions, press the **UP** or **Down** buttons and the **SETUP** button to move to the next position to the right on the CD display.

The default **1** will be used for this example.

Press the **ENTER** button.

14 RELAY: REM RLY 1
0 % LEL
0 % LEL
0 % LEL

Press the **UP** button.

15 RELAY: REM RLY 2
0 % LEL
0 % LEL
0 % LEL

Press the **ENTER** button.

16 FAILSAFE: NO
0 % LEL
0 % LEL
0 % LEL

As we are using the default setting, **NO**,
press the **ENTER** button.

17 A1
0 % LEL
0 % LEL
0 % LEL

The factory default **A1** will be used but additional
programming will be added for this example.
Press the **SETUP** button.

18 A1
0 % LEL
0 % LEL
0 % LEL

Press the **SETUP** button.

19 A1!
0 % LEL
0 % LEL
0 % LEL

Press the **UP** or **DOWN** button to select **&**.

20 A1&
0 % LEL
0 % LEL
0 % LEL

Press the **SETUP** button.

21 A1&!
0 % LEL
0 % LEL
0 % LEL

Press the **UP** or **DOWN** button to select **A**. Press
the **SETUP** button.

22 A1&A!
0 % LEL
0 % LEL
0 % LEL

Press the **UP** or **DOWN** button to select 4.

Press the **SETUP** button.

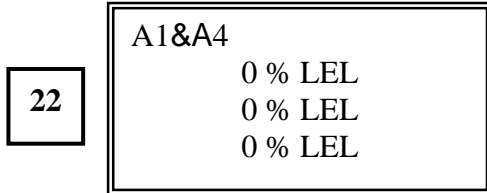

Press the **SETUP** button.

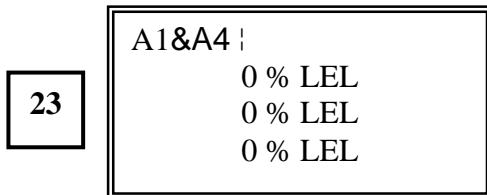

To return to the Factory Default settings **A1**, press the **SETUP** button until the program position wraps around to the position after

A1.

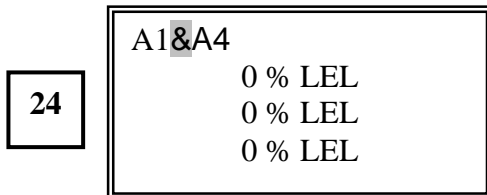

Press the **SILENCE/RESET** button three times to delete &, A and 4. After pressing the **SILENCE/RESET** button three times, this screen will be displayed.

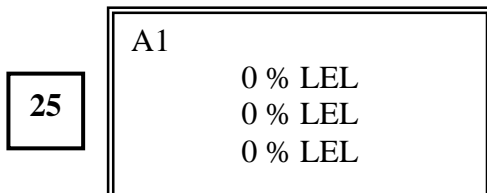

You have finished programming relay 1 to activate when Channel 1 goes into alarm.

For another example we will show Remote Relay 3 programmed to operate if either Channel 1 or Channel 2 goes into warn.

Press the **ENTER** button.

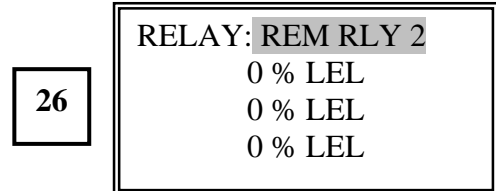

Press the **UP** button.

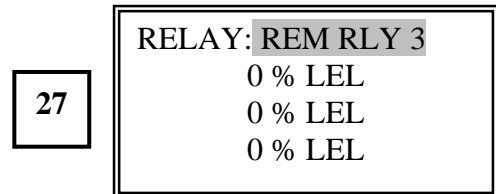

Press the **ENTER** button.

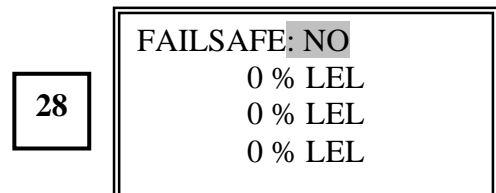

Press the **ENTER** button.

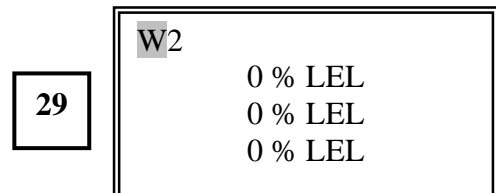

The Factory Default is W2. Press **SETUP** twice.

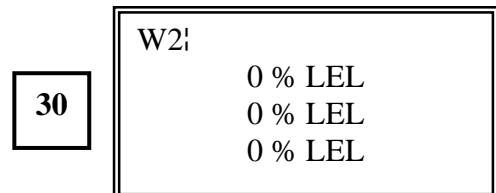

Press the **DOWN** button 4 times.

31 W2 |
0 % LEL
0 % LEL
0 % LEL

Press the **SETUP** button.

32 W2|;
0 % LEL
0 % LEL
0 % LEL

Press the **UP** button.

33 W2|W
0 % LEL
0 % LEL
0 % LEL

Press the **SETUP** button.

34 W2|W|
0 % LEL
0 % LEL
0 % LEL

Press the **UP** button 4 times.

35 W2|W1
0 % LEL
0 % LEL
0 % LEL

Press the **ESCAPE** button times. To return to the Save Setup Screen to save the setup.

36 SAVE SETUP? YES
0 % LEL
0 % LEL
0 % LEL

Press the **ENTER** button. This display is shown for 2 seconds.

37 SYSTEM SAVED
0 % LEL
0 % LEL
0 % LEL

After the 2 seconds has timed out, the default display is shown.

38 0 % LEL
0 % LEL
0 % LEL
0 % LEL

You have now returned to run/active mode. Any WARN setpoint that is activated on either Channels 1 or 2 will cause Remote Relay 3 to activate.

System Maintenance

General

Due to the unique microprocessor circuitry design and proven reliability of the QuadScan II, a set maintenance schedule is not required. However, a visual alarm and relay check can be performed at customer selected intervals to verify proper system operation.



CAUTION: CORRECTIVE DEVICES CONNECTED TO THE ALARM RELAY CONTACTS MUST BE DISABLED BEFORE PERFORMING THE FOLLOWING TESTS UNLESS IT IS INTENDED TO ALSO VERIFY THE OPERATION OF THE REMOTE ANNUCIATORS.

Alarm/Relay Check

1. Remove the cover plate located on the lower bottom section of the enclosure.
2. Identify the Channel 1 current loop input wires located on TB1 and disconnect. The fail LED will illuminate and the fail common relay will activate (change state). The internal horn will not activate.
3. Connect a current generator with a range of 0 to 20 mA, (observe correct polarity), to the (+) **IN** and (-) **IN** terminals on TB1. The fail LED will extinguish and the fail relay will return to normal if the output is set to 4ma or above.

For toxic or combustible monitoring channels, follow steps 4 through 8. For oxygen deficiency monitoring channels, follow steps 9 through 13.

4. Set the current generator for 4 mA and input to the system. The LCD will indicate 0.0.
5. Set the current generator for 20mA to simulate a high toxic or combustible gas condition and input to the system. The LCD will indicate the programmed full scale for a specific gas. The warn and alarm LEDs will be illuminated and flashing, warn and alarm common relays will activate (change state). The internal horn will be activated and the common horn relay will also be activated. The fail LED and relay will not be activated.
6. Reset the current generator to 4mA and input. The LCD display will return to 0.0. If the LEDs and relays are still activated press the reset button and the LEDs and relays will now deactivate.
7. Set the current generator to the programmed fault level to simulate an fault condition. The Status LED will illuminate and flash yellow, the LCD will indicate a negative value

corresponding to the mA input. The internal horn will not activate unless programmed by the user to do so. Pressing the silence/reset button will cause the LED to stop flashing and remain steady.

8. Reset the current generator to 4mA and input. The LCD display will return to 0.0. If the LEDs and relays are still activated press the reset button the LEDs and relays will now deactivate.

Note: The following test assumes an oxygen range of 0% to 25%.

9. Set the current generator for 17.4 mA and input to the system. The LCD will indicate approximately 20.9 %, which is a normal oxygen atmosphere and the QuadScan II will indicate normal operation. Alarm LEDs or alarm relays will not be activated.
10. Reset the current generator to 12.0 mA and input. The LCD will indicate 12.5%. The warn and alarm LEDs will be illuminated and flashing, the warn and alarm common relays will activate (change state). The internal horn will be activated and the common horn relay will also be activated. The fail LED and fail relay will not be activated.
11. Set the current generator to the programmed current of 18.7 mA to simulate an inhibit condition. The LCD will display approximately 23 %. The Channel Status LED will illuminate and flash yellow. The internal horn will not activate. Reset the current generator to 17.4 mA and input. The LCD will indicate 20.9 % if the LEDs and relays are still activated. Press the reset button and the LEDs and relays will now deactivate.
12. Disconnect the current generator. Reconnect the loop wires and move to channel 2 through 4.

Note: If any of the conditions described do not function, refer to the Troubleshooting Section.

Troubleshooting

General

Troubleshooting the QuadScan II can be accomplished by isolating the CPU/power supply boards or the display/function assembly. In most cases, the problem will be isolated to a sensor or transmitter failure. Reference the appropriate transmitter manual for specific transmitter troubleshooting procedures. If the problem exists in the receiver/controller and not the sensor or transmitter, then determine if the problem is common to all channels or just a specific channel. The following procedure can be used to help isolate the problem area.



CAUTION: CORRECTIVE DEVICES CONNECTED TO THE ALARM RELAY CONTACTS MUST BE DISABLED BEFORE PERFORMING THE FOLLOWING TESTS.

Channel Test Setup

1. Remove the cover plate located on the lower bottom section of the enclosure.
2. Identify the Channel 1 current loop input wires located on TB1 and disconnect. The Fail LED will illuminate and the fail common relay will activate (change state). The internal horn will not activate.
3. Connect a current generator with a range of 0 to 20 mA, (observe correct polarity), to the (+) **IN** and (-) **IN** terminals on TBI. The fail LED will extinguish and the fail relay will return to normal.

For additional details on the testing procedure, refer to System Maintenance.

Refer to Table 2 for additional help in isolating or locating the malfunction.

Once the problem area has been diagnosed, because of the complexity of the circuit board design, all repairs should be limited to interchanging circuit boards. Circuit boards are available as spare parts or can be purchased as required from Scott Health & Safety.

The following table will help identify and locate possible malfunctions in the event of a system failure.

Problem	Possible Cause	Possible Remedy
Fail LED flashing	Transmitter failure Loop open or shorted	Check transmitter manual
Continuous high alarm condition	Transmitter failure High gas condition Alarms in latched mode	Check transmitter manual Normal Press Reset button
Function switches not operating correctly	Function switches Ribbon cable	Replace Display/Function Assembly Replace/tighten Ribbon cable
LCD not indicating correct data	CPU/PS board failure Ribbon cable Display board	Replace CPU/PS boards Replace/tighten cable Replace Display board
No visible displays on front panel	No power input Ribbon cable CPU/PS board	Check input voltage Replace/tighten cable Replace CPU/PS boards Blown fuse on power supply
All programming functions inoperable	Ribbon cable CPU/PS boards	Replace/tighten Ribbon cable Replace CPU/PS boards
Common relays inoperable	CPU/PS boards	Replace CPU/PS boards
Common Warn, or Alarm, or Fail or Horn relays inoperable	Relay CPU/PS boards	Replace Relay Replace CPU/PS boards
Internal Horn not functional	Horn Horn connector CPU/PS boards Display board	Replace Horn Reconnect or Replace Replace CPU/PS boards Replace Display board
No current output	No current input	Check transmitter manual

	CPU/PS boards	Replace CPU/PS boards
Alarm LEDs operational but Status LEDs inoperable	Display board Ribbon cable CPU/PS boards	Replace Display board Replace/tighten Ribbon cable Replace CPU/PS boards
Status LEDs operational but Alarm LEDs inoperable	Display board Ribbon cable CPU/PS boards	Replace Display board Replace/tighten Ribbon cable Replace CPU/PS boards
Individual Alarm or Status LED inoperable	LED Display board	Replace LED Replace Display board
Inhibit function does not operate	CPU/PS board	Replace CPU/PS board
All Remote Relays not operational	Cable or wire connection Remote Relay board	Replace or re-strip cable Replace Relay board
Relay 1,2,3,4,5,6,7 or 8 do not operate	Relay Cable or wire connection	Replace Relay Replace or re-strip cable

Table 2 - Identify and Locate Possible Malfunctions During System Failure

Spare Parts

QuadScan II

Description	Part Number
Power Supply Main I/O Board	096-2383
CPU & Display Board	096-2384
Touch Pad/Function Assembly – (Less Door)	071-0159
Display Circuit Board Assembly Only (attaches to CPU board)	096-2689
Enclosure Rear Section Only	096-2728
Enclosure Center Section Only	063-0074
Enclosure Hinge Covers Only (pair)	063-0076
Enclosure Display Front Cover with Clear Window	063-0075
Interconnecting Ribbon Cable (Power Supply to Display Board)	096-2692
Horn Assembly (Internal)	086-0004
Power Supply Module located on Power Supply board	028-0035
Terminal Strip Connector for TB1, TB2, TB5 and TB6	037-0104
Terminal Strip Connector for TB3	037-0103
Terminal Strip Connector for TB4	037-0102
Terminal Strip Connector for TB7	037-0105

Remote Relay Assembly

Description	Part Number
Complete Relay Assembly less cable	096-2691
NEMA 4X Enclosure with drilled holes	096-2729-2

Circuit Board Assembly - Complete	096-2688
Ten ft. Interconnecting 6 Conductor Cable –specify length required	069-0065
Up to 50 ft. maximum	

Scott Health & Safety Warranty

General Policy Coverage

The manufacturer warrants to the original purchaser and /or ultimate customer of the manufacturer's products that if any part(s) thereof (except for those listed below) prove(s) to be defective in material or workmanship within 18 months from the date of shipment or 12 months from the date of start-up, whichever comes first. Such defective part(s) will be repaired or replaced free of charge if shipped prepaid to the factory in a package equal to (or) original container.

Exceptions to this general warranty policy are:

Gas Sensors

Gas sensors which are part of certain products are covered by a 12-month warranty. Should a failure occur within 12 months of shipment, the sensor will be replaced at no charge, providing the sensor has been used and installed in accordance with O&M Manual recommendations. The Phosgene sensor COCl₂ has a warranty of six months.

Terms and Conditions

All products will be returned freight prepaid and allowed if it is determined by the manufacturer that the part(s) failed due to defective materials or workmanship. The seller assumes no liability for consequential damages of any kind, and the buyer by acceptance of this equipment will assume all liability for the consequences of its use or misuse by the buyer, his employees, or others. A defect within the meaning of this warranty in any part of any piece of equipment shall not, when such part is capable of being renewed, repaired, or replaced, operate to condemn such piece of equipment. This warranty does not cover consumable items, batteries, or wear items subject to periodic replacement including lamps and fuses. This warranty is in lieu of all other warranties (including without limiting the generality of the foregoing warranties of merchantability and fitness for a particular purpose), guarantees, obligations, or liabilities expressed or implied by the seller or its representatives and by the statute or rule of law. This warranty is void if the instrument has been subject to misuse or abuse, or has not been operated in accordance with instructions, or if the serial number has been removed.

SCOTT HEALTH & SAFETY MAKES NO OTHER WARRANTY EXPRESSED OR IMPLIED EXCEPT AS STATED ABOVE.

Year 2000 Compliance

The QuadScan II accepts all dates in the years after 1999 as valid dates. The instrument's functionality, performance, and accuracy will not be affected as a result of the run date or dates being processed, irrespective of the century.

Contacting Scott Health & Safety

Scott Health & Safety

4320 Goldmine Rd

Monroe, North Carolina 28110 USA

Phone (704)291-8400 • FAX (704)291-8340

www.scotthealthsafety.com

Technical Specifications

QuadScan II

Configurations:	1,2,3,or 4 Channels
Enclosure:	NEMA 4X Wall Mount Noryl plastic with stainless steel screws and hinges
Weight:	4 lbs. (1.8 Kg)
Power Requirements:	90-260 VAC, 50/60 Hz, 80W. or 24VDC, 400mA max.
Inputs:	Maximum Four 4-20 mA current loops, 2, 3 or 4 wire. Dry contact inputs also available.
Outputs:	Four isolated analog 0-20mA (max) self powered (do not apply 24VDC to outputs) common & optional remote relays
Displays:	LCD, backlit, with 4 individual 16 character alphanumeric displays. Individual channel LED indication for OK, fail, inhibit, low alarm and high alarm
Relays (common):	Low alarm, high alarm, fail and horn – 24VDC SPDT 5A resistive
Accuracy:	± 2% full scale
Repeatability:	± 0.5% full scale
Temperature range:	-13° F to 122°F (-25°C to 50°C)
Humidity Range:	0 to 99% R.H.
Piezo Sound Level:	85dB @ 1 foot
Approvals:	Classified to CSA 22.2 No. 1010.1 and ISA-S82
Warranty:	1 Year

Optional Remote Relay

Configuration:	Eight (8) programmable Relays 6 relays SPDT, 5 A, 30 VDC – 277 VAC 2 relays DPDT, 5 A, 30 VDC – 277 VAC
Enclosure:	NEMA 4X polycarbonate 94V-2 (wall mount)
Temperature	-40° F to 176°F (-40°C to 80°C)
Weight:	1 lb. (.5 Kg)
Inputs:	10 ft. - 6 conductor cable (Cable lengths are available up to 50 ft.)

Factory Default Settings

All 4 channels have the same factory default settings. Sometimes the factory will perform custom setups.

SETTINGS	FACTORY DEFAULT
CHANNEL	ON
FULL SCALE	100
UNITS	%
TAG	LEL
DAMPING(S)	2
ZERO DB(%FS)	0
INHIBIT(mA)	3.6
FAULT(mA)	2.0
ALARM INHIBIT	NONE
COMMON FAIL RLY -FAILSAFE	YES
COMMON WARN RLY FAILSAFE	NO
COMMON ALARM RLY FAILSAFE	NO
COMMON HORN RLY FAILSAFE	NO
WARN SET POINT	25
WARN RESET	20
WARN DELAY	0
WARN HOLD	0
WARN LATCH	NO
ALARM SET POINT	50
ALARM RESET	45
ALARM DELAY	0
ALARM HOLD	0

SETTINGS	FACTORY DEFAULT
ALARM LATCH	NO
REMOTE RELAYS 1 – 8 FAILSAFE	NO
REMOTE RELAY 1	W1
REMOTE RELAY 2	A1
REMOTE RELAY 3	W2
REMOTE RELAY 4	A2
REMOTE RELAY 5	W3
REMOTE RELAY 6	A3
REMOTE RELAY 7	W4
REMOTE RELAY 8	A4

Table 3 - Factory Default Settings for Receiver/Controller

Customer Work Sheet

LISTING PROGRAMMING SELECTIONS Channel 1

SETTINGS	FACTORY DEFAULT	PROGRAMMING OPTIONS	CUSTOMER SELECTION
SYSTEM INHIBIT	NONE	NONE/ALL	
FULL SCALE	100	1.00-10.00 10.0-100.0 100-1999	
UNITS	%	%, PPM, PPB NONE	
TAG	LEL	UP TO 6 LETTERS, NUMBERS OR SYMBOLS (see footnote 1)	
DAMPING(S)	2	0 to 10	
ZERP DB(%FS)	0	0 to 5	
INHIBIT(mA)	3.6	2.0 to 20	
FAULT(mA)	3.5	0.1 to 20.0	
CHANNEL INHIBIT	ON	ON/OFF/IHB	
COMMON FAIL RLY -FAILSAFE	YES	NOT PROGRAMMABLE	
COMMON WARN RLY FAILSAFE	NO	NO/YES	
COMMON ALARM RLY FAILSAFE	NO	NO/YES	
COMMON HORN RLY FAILSAFE	NO	NO/YES	
WARN SET POINT	25	.01 to 1999	
WARN RESET	20	.01 to 1999	

WARN DELAY	0	0 to 10	
WARN HOLD	0	0 to 7200	
WARN LATCH	NO	NO/YES	
ALARM SET POINT	50	.01 to 1999	
ALARM RESET	45	.01 to 1999	
ALARM DELAY	0	0 to 10	
ALARM HOLD	0	0 to 7200	
ALARM LATCH	NO	NO/YES	

The following numbers, letters and symbols will be used to identify a specific gas being monitored on the channel you are working on for example, **PPB**. Identification can also be listed for sensor/transmitter locations. Six letters, numbers and symbols, in any combination, can be used.

**A – Z, ! " # \$ % & ' () * +
, - . / 0 – 9 : ; < = > ? xx**

LISTING PROGRAMMING SELECTIONS Channel 2

SETTINGS	FACTORY DEFAULT	PROGRAMMING OPTIONS	CUSTOMER SELECTION
SYSTEM INHIBIT	NONE	NONE/ALL	
FULL SCALE	100	1.00-10.00 10.0-100.0 100-1999	
UNITS	%	%, PPM, PPB NONE	
TAG	LEL	UP TO 6 LETTERS, NUMBERS OR SYMBOLS (see footnote 1)	
DAMPING(S)	2	0 to 10	
ZERP DB(%FS)	0	0 to 5	
INHIBIT(mA)	3.6	2.0 to 20	
FAULT(mA)	3.5	0.1 to 20.0	
CHANNEL INHIBIT	ON	ON/OFF/IHB	
COMMON FAIL RLY -FAILSAFE	YES	NOT PROGRAMMABLE	
COMMON WARN RLY FAILSAFE	NO	NO/YES	
COMMON ALARM RLY FAILSAFE	NO	NO/YES	
COMMON HORN RLY FAILSAFE	NO	NO/YES	
WARN SET POINT	25	.01 to 1999	
WARN RESET	20	.01 to 1999	
WARN DELAY	0	0 to 10	
WARN HOLD	0	0 to 7200	
WARN LATCH	NO	NO/YES	
ALARM SET POINT	50	.01 to 1999	

ALARM RESET	45	.01 to 1999	
ALARM DELAY	0	0 to 10	
ALARM HOLD	0	0 to 7200	
ALARM LATCH	NO	NO/YES	

The following numbers, letters and symbols will be used to identify a specific gas being monitored on the channel you are working on, for example, **PPB**. Identification can also be listed for sensor/transmitter locations. Six letters, numbers and symbols, in any combination can be used.

A – Z, ! " # \$ % & ' () * +

, - . / 0 – 9 : ; < = > ? xx

LISTING PROGRAMMING SELECTIONS Channel 3

SETTINGS	FACTORY DEFAULT	PROGRAMMING OPTIONS	CUSTOMER SELECTION
SYSTEM INHIBIT	NONE	NONE/ALL	
FULL SCALE	100	1.00-10.00 10.0-100.0 100-1999	
UNITS	%	%, PPM, PPB NONE	
TAG	LEL	UP TO 6 LETTERS, NUMBERS OR SYMBOLS (see footnote 1)	
DAMPING(S)	2	0 to 10	
ZERP DB(%FS)	0	0 to 5	
INHIBIT(mA)	3.6	2.0 to 20	
FAULT(mA)	3.5	0.1 to 20.0	
CHANNEL INHIBIT	ON	ON/OFF/IHB	
COMMON FAIL RLY -FAILSAFE	YES	NOT PROGRAMMABLE	
COMMON WARN RLY FAILSAFE	NO	NO/YES	
COMMON ALARM RLY FAILSAFE	NO	NO/YES	
COMMON HORN RLY FAILSAFE	NO	NO/YES	
WARN SET POINT	25	.01 to 1999	
WARN RESET	20	.01 to 1999	
WARN DELAY	0	0 to 10	
WARN HOLD	0	0 to 7200	

WARN LATCH	NO	NO/YES	
ALARM SET POINT	50	.01 to 1999	
ALARM RESET	45	.01 to 1999	
ALARM DELAY	0	0 to 10	
ALARM HOLD	0	0 to 7200	
ALARM LATCH	NO	NO/YES	

The following numbers, letters and symbols will be used to identify a specific gas being monitored on the channel you are working on, for example, **PPB**. Identification can also be listed for sensor/transmitter locations. Six letters, numbers and symbols, in any combination can be used.

**A – Z, ! " # \$ % & ' () * +
, - . / 0 – 9 : ; < = > ? xx**

LISTING PROGRAMMING SELECTIONS Channel 4

SETTINGS	FACTORY DEFAULT	PROGRAMMING OPTIONS	CUSTOMER SELECTION
SYSTEM INHIBIT	NONE	NONE/ALL	
FULL SCALE	100	1.00-10.00 10.0-100.0 100-1999	
UNITS	%	%, PPM, PPB NONE	
TAG	LEL	UP TO 6 LETTERS, NUMBERS OR SYMBOLS (see footnote 1)	
DAMPING(S)	2	0 to 10	
ZERP DB(%FS)	0	0 to 5	
INHIBIT(mA)	3.6	2.0 to 20	
FAULT(mA)	3.5	0.1 to 20.0	
CHANNEL INHIBIT	ON	ON/OFF/IHB	
COMMON FAIL RLY -FAILSAFE	YES	NOT PROGRAMMABLE	
COMMON WARN RLY FAILSAFE	NO	NO/YES	
COMMON ALARM RLY FAILSAFE	NO	NO/YES	
COMMON HORN RLY FAILSAFE	NO	NO/YES	
WARN SET POINT	25	.01 to 1999	
WARN RESET	20	.01 to 1999	
WARN DELAY	0	0 to 10	
WARN HOLD	0	0 to 7200	

WARN LATCH	NO	NO/YES	
ALARM SET POINT	50	.01 to 1999	
ALARM RESET	45	.01 to 1999	
ALARM DELAY	0	0 to 10	
ALARM HOLD	0	0 to 7200	
ALARM LATCH	NO	NO/YES	

The following numbers, letters and symbols will be used to identify a specific gas being monitored on the channel you are working on, for example, **PPB**. Identification can also be listed for sensor/transmitter locations. Six letters, numbers and symbols, in any combination can be used.

**A - Z, ! " # \$ % & ' () * +
, - . / 0 - 9 : ; < = > ? xx**

LISTING PROGRAMMING SELECTIONS REMOTE RELAYS

SETTINGS	FACTORY DEFAULT	PROGRAMMING OPTIONS	CUSTOMER SELECTIONS
REMOTE RELAYS 1 – 8 FAILSAFE	NO	NO/YES	
REMOTE RELAY 1	W1	(See Footnote 2)	
REMOTE RELAY 2	A1	(See Footnote 2)	
REMOTE RELAY 3	W2	(See Footnote 2)	
REMOTE RELAY 4	A2	(See Footnote 2)	
REMOTE RELAY 5	W3	(See Footnote 2)	
REMOTE RELAY 6	A3	(See Footnote 2)	
REMOTE RELAY 7	W4	(See Footnote 2)	
REMOTE RELAY 8	A4	(See Footnote 2)	

2. The following Numbers, Letters and Symbols will be used to program a specific relay from the factory default setting, for example, **(W1&W2)|(W2&A3)**. Thirty Two (32) letters, numbers and symbols are available to program the required formula.

W, A, F, 1, 2, 3, 4, &, |, (,)

Relay 1: _____

Relay 2: _____

Relay 3: _____

Relay 4: _____

Relay 5: _____

Relay 6: _____

Relay 7: _____

Relay 8: _____

Appendix A

The following will familiarize you with actual examples.

Programming Example 1

Two sensor/transmitters, one for chlorine and one for hydrogen sulfide are installed, operating and calibrated. A four channel QuadScan II has been purchased to interface with these transmitters. The chlorine sensor/transmitter is wired to channel 1 and the hydrogen sulfide sensor/transmitter is wired to channel 3. Channels 2 and 4 will not be used at this time. Security/password will not be used. Remote relays will not be connected to the QuadScan II. The starting point for the programming sequence will be the LEL default display:

1

```

0 % LEL
0 % LEL
0 % LEL
0 % LEL
    
```

Press the **SETUP** button.

2

```

* SETUP*
0 % LEL
0 % LEL
0 % LEL
    
```

Press the **ENTER** button.

3

```

SECURITY MENU
0 % LEL
0 % LEL
0 % LEL
    
```

The **SECURITY MENU** will not be programmed.

Press the **DOWN** button.

4

```

SYSTEM MENU
0 % LEL
0 % LEL
0 % LEL
    
```

Press the **ENTER** button.

5

```

VERSION *
0 % LEL
0 % LEL
0 % LEL
    
```

Press the **UP** or **DOWN** button to scroll to **SET LOCAL RELAYS**. All other functions have been previously setup or not used.

6

SET LOCAL RELAYS 0 % LEL 0 % LEL 0 % LEL
--

Press the **ENTER** button.

7

RELAY: CMN FAIL 0 % LEL 0 % LEL 0 % LEL

Press the **ENTER** button.

8

FAILSAFE: YES 0 % LEL 0 % LEL 0 % LEL

The **Fail Relay** cannot be set in any other mode. Press the **ENTER** button

9

RELAY: CMN FAIL 0 % LEL 0 % LEL 0 % LEL

Press the **UP** button.

10

RELAY: CMN WARN 0 % LEL 0 % LEL 0 % LEL

Press the **UP** button.

11

RELAY: CMN ALARM 0 % LEL 0 % LEL 0 % LEL
--

Press the **ENTER** button.

12

FAILSAFE: NO 0 % LEL 0 % LEL 0 % LEL
--

Press the **UP** or **DOWN** button and select **YES**.

13

FAILSAFE: YES 0 % LEL 0 % LEL 0 % LEL

Press the **ENTER** button.

14

RELAY: CMN ALARM 0 % LEL 0 % LEL 0 % LEL
--

Press the **UP** button.

15 RELAY: CMN HORN
0 % LEL
0 % LEL
0 % LEL

Press the **ESCAPE** button.

16 SET LOCAL RELAYS
0 % LEL
0 % LEL
0 % LEL

***Current Software Version displayed.**

Press the **ESCAPE** button.

17 SYSTEM MENU
0 % LEL
0 % LEL
0 % LEL

Press the **DOWN** button.

18 CHANNEL MENU
0 % LEL
0 % LEL
0 % LEL

Press the **ENTER** button.

19 ON/OFF/IHB: ON
0 % LEL
0 % LEL
0 % LEL

Press the **UP** button.

20 SENSOR: 4 – 20 mA
0 % LEL
0 % LEL
0 % LEL

Press the **UP** button.

21 FULL SCALE: 100
0 % LEL
0 % LEL
0 % LEL

Press the **ENTER** button.

22 FULL SCALE: 100
0 % LEL
0 % LEL
0 % LEL

Press the **DOWN** button and hold to scroll to **10.0**. Press the **ENTER** button.

23 FULL SCALE: 10.0
0 % LEL
0 % LEL
0 % LEL

Press the **UP** button.

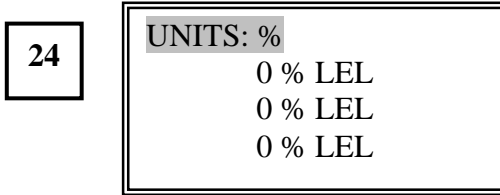

Press the **ENTER** button.

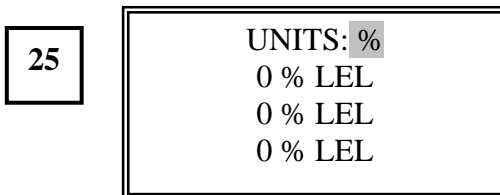

Press the **DOWN** button and scroll to **PPM**.
Press the **ENTER** button.

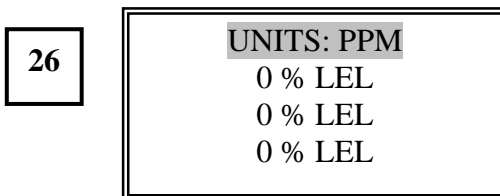

Press the **UP** button.

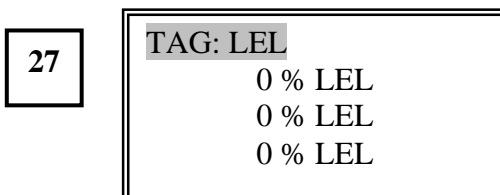

Press the **ENTER** button.

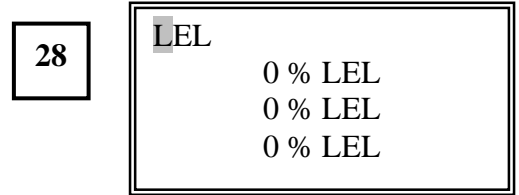

Press the **DOWN** button to scroll to the **C**.

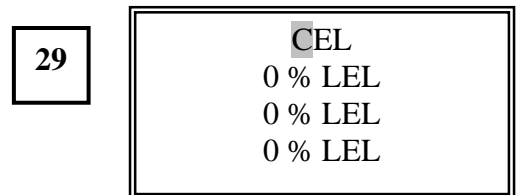

Press the **SETUP** button.

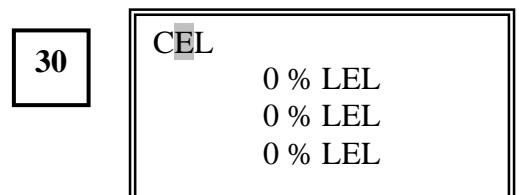

Press the **UP** button and scroll to **L**.

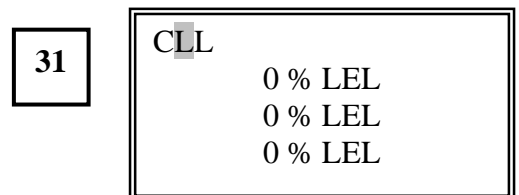

Press the **SETUP** button.

32 CLL
0 % LEL
0 % LEL

Press the **DOWN** button and scroll to **2**.

33 CL2
0 % LEL
0 % LEL
0 % LEL

Press the **ENTER** button.

34 TAG: CL2
0 % LEL
0 % LEL
0 % LEL

Press the **ENTER** button.

35 DAMPING(S): 2
0 % LEL
0 % LEL
0 % LEL

Note: The **DAMPING** may require increasing if the display is found to be unstable. Press the **UP** button

36 ZERO DB(%FS): 0
0 % LEL
0 % LEL
0 % LEL

Press the **UP** button.

37 INHIBIT(MA): 3.6
0 % LEL
0 % LEL
0 % LEL

Press the **UP** button.

38 FAULT(MA): 2.0
0 % LEL
0 % LEL
0 % LEL

Press the **UP** button.

39 SETUP WARNING
0 % LEL
0 % LEL
0 % LEL

Press the **ENTER** button.

40

WARN SET: 2.5
0 % LEL
0 % LEL
0 % LEL

Press the **ENTER** button.

41

WARN SET: 2.5
0 % LEL
0 % LEL
0 % LEL

Press the **DOWN** button to scroll to **0.5**.

Press the **ENTER** button.

42

WARN SET: 0.5
0 % LEL
0 % LEL
0 % LEL

Press the **UP** button.

43

WARN RES: 2.0
0 % LEL
0 % LEL
0 % LEL

Press the **ENTER** button.

44

WARN RES: 2.0
0 % LEL
0 % LEL
0 % LEL

Press the **DOWN** button and hold to scroll to **0.4**. Press the **ENTER** button

45

WARN RES: 0.4
0 % LEL
0 % LEL
0 % LEL

Press the **ENTER** button.

46

WARN RES: 0.4
0 % LEL
0 % LEL
0 % LEL

Press the **UP** button.

47

WARN DLY: 0
0 % LEL
0 % LEL
0 % LEL

Press the **UP** button.

48

WARN HLD: 0 0 % LEL 0 % LEL 0 % LEL

Press the **UP** button.

49

WARN LAT: NO 0 % LEL 0 % LEL 0 % LEL
--

Press the **UP** button.

50

WARN SET: .5 0 % LEL 0 % LEL 0 % LEL
--

Press the **ESCAPE** button.

51

SETUP WARNING 0 % LEL 0 % LEL 0 % LEL

Press the **UP** button.

52

SETUP ALARM 0 % LEL 0 % LEL 0 % LEL

Press the **ENTER** button.

53

ALARM SET: 5.0 0 % LEL 0 % LEL 0 % LEL
--

Press the **ENTER** button.

54

ALARM SET: 5.0 0 % LEL 0 % LEL 0 % LEL
--

Press the **DOWN** button to scroll to **1.0**. Press the **ENTER** button.

55

ALARM SET: 1.0 0 % LEL 0 % LEL 0 % LEL
--

Press the **UP** button.

56

ALARM RES: 4.5
0 % LEL
0 % LEL
0 % LEL

Press the **ENTER** button.

57

ALARM RES: 4.5
0 % LEL
0 % LEL
0 % LEL

Press the **DOWN** button to scroll to **0.8**.

Press the **ENTER** button.

58

ALARM RES: 0.8
0 % LEL
0 % LEL
0 % LEL

Press the **UP** button.

59

ALARM DLY: 0
0 % LEL
0 % LEL
0 % LEL

Press the **UP** button.

60

ALARM HLD: 0
0 % LEL
0 % LEL
0 % LEL

Press the **UP** button.

61

ALARM LAT: NO
0 % LEL
0 % LEL
0 % LEL

Press the **ENTER** button.

62

ALARM LAT: NO
0 % LEL
0 % LEL
0 % LEL

Press the **UP** or **DOWN** button to scroll to **YES**. Press the **ENTER** button.

63

ALARM LAT: YES
0 % LEL
0 % LEL
0 % LEL

Press the **ENTER** button.

64

ALARM LAT: YES
0 % LEL
0 % LEL
0 % LEL

Press the **UP** button.

65
ALARM SET: 1.0
 0 % LEL
 0 % LEL
 0 % LEL

Press the **ESCAPE** button.

69
CAL LOOP INPUT
 0 % LEL
 0 % LEL
 0 % LEL

Press the **ESCAPE** button

66
SETUP ALARM
 0 % LEL
 0 % LEL
 0 % LEL

Press the **UP** button.

70
CAL LOOP OUTPUT
 0 % LEL
 0 % LEL
 0 % LEL

Press the **UP** button.

67
CAL LOOP INPUT
 0 % LEL
 0 % LEL
 0 % LEL

Press the **ENTER** button. The display scrolls
mA out = TB5 1,2

71
 mA out = TB5 1,2
 0 % LEL
 0 % LEL
 0 % LEL

Press the **ENTER** button. The display scrolls
Input 4 mA at TB1 2,3

68
 Input 4mA at TB1 2,3
 0 % LEL
 0 % LEL
 0 % LEL

Press the **ESCAPE** button.

72
CAL LOOP OUTPUT
 0 % LEL
 0 % LEL
 0 % LEL

Press the **UP** button.

73

ON/OFF/IHB: ON
0 % LEL
0 % LEL
0 % LEL

Press the **ESCAPE** button.

74

CHANNEL MENU
0 % LEL
0 % LEL
0 % LEL

Press the **ESCAPE** button.

75

SAVE SETUP? YES
0 % LEL
0 % LEL
0 % LEL

Press the **ENTER** button.

76

SETUP SAVED
0 % LEL
0 % LEL
0 % LEL

77

0.0 PPM CL2
0 % LEL
0 % LEL
0 % LEL

Press the **SETUP** button.

78

*** SETUP ***
0 % LEL
0 % LEL
0 % LEL

Press the **DOWN** button.

79

0.0 PPM CL2
*** SETUP ***
0 % LEL
0 % LEL

Press the **ENTER** button.

80

0.0 PPM CL2
SECURITY MENU
0 % LEL
0 % LEL

Press the **UP** button.

81

0.0 PPM CL2
CHANNEL MENU
0 % LEL
0 % LEL

Press the **ENTER** button.

82

0.0 PPM CL2
ON/OFF/IHB: ON
0 % LEL
0 % LEL

Press the **ENTER** button.

83

0.0 PPM CL2
ON/OFF/IHB: ON
0 % LEL
0 % LEL

Press the **DOWN** button.

84

0.0 PPM CL2
ON/OFF/IHB: OFF
0 % LEL
0 % LEL

Press the **ENTER** button.

85

0.0 PPM CL2
ON/OFF/IHB: OFF
0 % LEL
0 % LEL

Press the **ESCAPE** button.

86

0.0 PPM CL2
CHANNEL MENU
0 % LEL
0 % LEL

Press the **ESCAPE** button.

87

0.0 PPM CL2
SAVE SETUP? YES
0 % LEL
0 % LEL

Press the **ENTER** button.

88

0.0 PPM CL2
SYSTEM SAVED
0 % LEL
0 % LEL

89 0.0 PPM CL2
CHANNEL OFF
0 % LEL
0 % LEL

Press the **SETUP** button.

90 * SETUP *
CHANNEL OFF
0 % LEL
0 % LEL

Press the **DOWN** button.

91 0.0 PPM CL2
* SETUP *
0 % LEL
0 % LEL

Press the **DOWN** button.

92 0.0 PPM CL2
CHANNEL OFF
* SETUP *
0 % LEL

Press the **ENTER** button.

93 0.0 PPM CL2
CHANNEL OFF
SECURITY MENU
0 % LEL

The **SECURITY MENU** will not be programmed. Press the **UP** button

95 0.0 PPM CL2
CHANNEL OFF
CHANNEL MENU
0 % LEL

Press the **ENTER** button and scroll UP to
FULL SCALE: 100

95 0.0 PPM CL2
CHANNEL OFF
FULL SCALE: 100
0 % LEL

Press the **ENTER** button.

96 0.0 PPM CL2
CHANNEL OFF
FULL SCALE: 100
0 % LEL

Press the **DOWN** button and scroll to **50.0**.
Press the **ENTER** button

97

0.0 PPM CL2
CHANNEL OFF
FULL SCALE: 50.0
0 % LEL

Press the **UP** button.

98

0.0 PPM CL2
CHANNEL OFF
UNITS: %
0 % LEL

Press the **ENTER** button.

99

0.0 PPM CL2
CHANNEL OFF
UNITS: %
0 % LEL

Press the **UP** or **DOWN** button and scroll to **PPM**. Press the **ENTER** button.

100

0.0 PPM CL2
CHANNEL OFF
UNITS: PPM
0 % LEL

Press the **ENTER** button.

101

0.0 PPM CL2
CHANNEL OFF
UNITS: PPM
0 % LEL

Press the **UP** button.

102

0.0 PPM CL2
CHANNEL OFF
TAG: LEL
0 % LEL

Press the **ENTER** button.

103

0.0 PPM CL2
CHANNEL OFF
LEL
0 % LEL

Press the **DOWN** button to scroll to **H**
Press the **ENTER** button.

104

0.0 PPM CL2
CHANNEL OFF
HEL
0 % LEL

Press the **SETUP** button.

105

0.0 PPM CL2
CHANNEL OFF
HEL
0 % LEL

Press the **UP** button and scroll to **2**.

Press the **SETUP** button.

106

0.0 PPM CL2
CHANNEL OFF
H2L
0 % LEL

Press the **UP** button and scroll to **S**.

Press the **ESCAPE** button.

107

0.0 PPM CL2
CHANNEL OFF
H2S
0 % LEL

Press the **ENTER** button.

108

0.0 PPM CL2
CHANNEL OFF
TAG :H2S
0 % LEL

109

0.0 PPM CL2
CHANNEL OFF
DAMPING(S): 2
0 % LEL

Press the **UP** button.

110

0.0 PPM CL2
CHANNEL OFF
ZERO DB(%FS): 0
0 % LEL

Press the **UP** button.

111

0.0 PPM CL2
CHANNEL OFF
INHIBIT(mA): 3.6
0 % LEL

Press the **UP** button.

112

0.0 PPM CL2
CHANNEL OFF
FAULT(mA): 3.5
0 % LEL

Press the **UP** button.

113

0.0 PPM CL2
CHANNEL OFF
SETUP WARNING
0 % LEL

Press the **ENTER** button.

117

0.0 PPM CL2
CHANNEL OFF
WARN SET: 5.0
0 % LEL

Press the **ENTER** button.

114

0.0 PPM CL2
CHANNEL OFF
WARN SET: 2.5
0 % LEL

Press the **UP** button.

118

0.0 PPM CL2
CHANNEL OFF
WARN RES: 2.0
0 % LEL

115

0.0 PPM CL2
CHANNEL OFF
WARN SET: 2.5
0 % LEL

Press the **ENTER** button.

119

0.0 PPM CL2
CHANNEL OFF
WARN RES: 2.0
0 % LEL

Press the **UP** button and scroll to **5.0**.

Press the **ENTER** button.

116

0.0 PPM CL2
CHANNEL OFF
WARN SET: 5.0
0 % LEL

Press the **UP** button and scroll to **4.8**.

Press the **ENTER** button.

120

0.0 PPM CL2
CHANNEL OFF
WARN RES: 4.8
0 % LEL

Press the **ENTER** button.

121

0.0 PPM CL2
CHANNEL OFF
WARN RES: 4.8
0 % LEL

Press the **UP** button.

122

0.0 PPM CL2
CHANNEL OFF
WARN DLY: 0
0 % LEL

Press the **UP** button.

123

0.0 PPM CL2
CHANNEL OFF
WARN HLD: 0
0 % LEL

Press the **UP** button.

124

0.0 PPM CL2
CHANNEL OFF
WARN LAT: NO
0 % LEL

Press the **ESCAPE** button.

125

0.0 PPM CL2
CHANNEL OFF
SETUP WARNING
0 % LEL

Press the **UP** button.

126

0.0 PPM CL2
CHANNEL OFF
SETUP ALARM
0 % LEL

Press the **ENTER** button.

127

0.0 PPM CL2
CHANNEL OFF
ALARM SET 5.0
0 % LEL

Press the **ENTER** button.

128

0.0 PPM CL2
CHANNEL OFF
ALARM SET: 5.0
0 % LEL

Press the **UP** button and scroll to **10.0**.

Press the **ENTER** button.

129

0.0 PPM CL2
CHANNEL OFF
ALARM SET 10.0
0 % LEL

Press the **UP** button.

130

0.0 PPM CL2
CHANNEL OFF
ALARM RES: 4.5
0 % LEL

Press the **ENTER** button.

131

0.0 PPM CL2
CHANNEL OFF
ALARM RES: 4.5
0 % LEL

Press the **UP** button and scroll to **9.5**

Press the **ENTER** button.

132

0.0 PPM CL2
CHANNEL OFF
ALARM RES: 9.5
0 % LEL

Press the **UP** button.

133

0.0 PPM CL2
CHANNEL OFF
ALARM DLY: 0
0 % LEL

Press the **UP** button.

134

0.0 PPM CL2
CHANNEL OFF
ALARM HLD: 0
0 % LEL

Press the **UP** button.

135

0.0 PPM CL2
CHANNEL OFF
ALARM LAT: NO
0 % LEL

Press the **ENTER** button.

136

0.0 PPM CL2
CHANNEL OFF
ALARM LAT: NO
0 % LEL

Press the **UP** or **DOWN** button and scroll to **YES**. Press the **ENTER** button.

137

0.0 PPM CL2
CHANNEL OFF
ALARM LAT: YES
0 % LEL

Press the **ESCAPE** button.

138

0.0 PPM CL2
CHANNEL OFF
:SETUP ALARM
0 % LEL

Press the **ESCAPE** button.

139

0.0 PPM CL2
CHANNEL OFF
CHANNEL MENU
0 % LEL

Press the **ESCAPE** button.

140

0.0 PPM CL2
CHANNEL OFF
SAVE SETUP? YES
0 % LEL

Press the **ENTER** button.

141

0.0 PPM CL2
CHANNEL OFF
SETUP SAVED
0 % LEL

142

0.0 PPM CL2
CHANNEL OFF
0.0 PPM H2S
0 % LEL

Press the **SETUP** button.

143

* SETUP *
CHANNEL OFF
0.0 PPM H2S
0 % LEL

Press the **DOWN** button and scroll to **Channel 4**.

144

0.0 PPM CL2
CHANNEL OFF
0.0 PPM H2S
* SETUP *

Press the **ENTER** button.

145 0.0 PPM CL2
CHANNEL OFF
0.0 PPM H2S
SECURITY MENU

Press the **UP** button.

146 0.0 PPM CL2
CHANNEL OFF
0.0 PPM H2S
CHANNEL MENU

Press the **ENTER** button.

147 0.0 PPM CL2
CHANNEL OFF
0.0 PPM H2S
ON/OFF/IHB: ON

Press the **ENTER** button.

148 0.0 PPM CL2
CHANNEL OFF
0.0 PPM H2S
ON/OFF/IHB: ON

Press the **DOWN** button and scroll to **OFF**.
Press the **ENTER** button

149 0.0 PPM CL2
CHANNEL OFF
0.0 PPM H2S
ON/OFF/IHB: OFF

Press the **ESCAPE** button.

150 0.0 PPM CL2
CHANNEL OFF
0.0 PPM H2S
CHANNEL MENU

Press the **ESCAPE** button.

151 0.0 PPM CL2
CHANNEL OFF
0.0 PPM H2S
SAVE SETUP? YES

Press the **ENTER** button.

152 0.0 PPM CL2
CHANNEL OFF
0.0 PPM H2S
CHANNEL OFF

This completes the setup for the specified scenario. However in actual operation, the alarm options may require settings that vary from the factory default settings.

Programming Example 2

Channel 1, 3 and 4 are programmed like programming example 1. Refer to programming Example 1. An oxygen sensor/transmitter has been added to Channel 2 of the instrument. All other conditions are the same as in programming example 1.

This is the starting point for programming the oxygen input.

1

0.0 PPM CL2
CHANNEL OFF
0.0 PPM H2S
CHANNEL OFF

Press the **SETUP** button and then press the **DOWN** button.

2

0.0 PPM CL2
* SETUP *
0.0 PPM H2S
CHANNEL OFF

Press the **ENTER** button.

3

0.0 PPM CL2
SECURITY MENU
0.0 PPM H2S
CHANNEL OFF

Press the **UP** button.

4

0.0 PPM CL2
CHANNEL MENU
0.0 PPM H2S
CHANNEL OFF

Press the **ENTER** button.

5

0.0 PPM CL2
ON/OFF/IHB: OFF
0.0 PPM H2S
CHANNEL OFF

Press the **DOWN** button and scroll to **ON**.

Press the **ENTER** button.

6

0.0 PPM CL2
ON/OFF/IHB: ON
0.0 PPM H2S
CHANNEL OFF

Press the **UP** button.

7

0.0 PPM CL2
SENSOR: 4-20mA
0.0 PPM H2S
CHANNEL OFF

Press the **UP** button.

8

0.0 PPM CL2
FULL SCALE: 100
0.0 PPM H2S
CHANNEL OFF

Press the **ENTER** button.

9 0.0 PPM CL2
FULL SCALE: 100
0.0 PPM H2S
CHANNEL OFF

Press the **DOWN** button and scroll to **25.0**.

Press the **ENTER** button.

10 0.0 PPM CL2
FULL SCALE: 25.0
0.0 PPM H2S
CHANNEL OFF

Press the **UP** button.

11 0.0 PPM CL2
UNITS: %
0.0 PPM H2S
CHANNEL OFF

Press the **UP** button.

12 0.0 PPM CL2
TAG: LEL
0.0 PPM H2S
CHANNEL OFF

Press the **ENTER** button.

13 LEL 0.0 PPM CL2
0.0 PPM H2S
CHANNEL OFF

Press the **UP** button and scroll to **O**. Press the **SETUP** button

14 OEL 0.0 PPM CL2
0.0 PPM H2S
CHANNEL OFF

Press the **DOWN** button and scroll to **2**.

Press the **SETUP** button.

15 O2L 0.0 PPM CL2
0.0 PPM H2S
CHANNEL OFF

Press the **DOWN** button and scroll to the **BLANK** position. Alternatively, you can press the **SILENCE/RESET** button and delete the character. Press the **ENTER** button.

16 0.0 PPM CL2
TAG: O2
0.0 PPM H2S
CHANNEL OFF

Press the **UP** button.

17 0.0 PPM CL2
DAMPING(S): 2
0.0 PPM H2S
CHANNEL OFF

Press the **UP** button.

18

0.0 PPM CL2
ZERO DB(%FS): 0
0.0 PPM H2S
CHANNEL OFF

Press the **UP** button.

19

0.0 PPM CL2
INHIBIT(mA): 3.6
0.0 PPM H2S
CHANNEL OFF

Press the **ENTER** button.

20

0.0 PPM CL2
INHIBIT(mA): 3.6
0.0 PPM H2S
CHANNEL OFF

Press the **UP** button and scroll to **18.5**.

Press the **ENTER** button.

21

0.0 PPM CL2
INHIBIT(mA): 18.5
0.0 PPM H2S
CHANNEL OFF

Press the **UP** button.

22

0.0 PPM CL2
FAULT(mA): 3.5
0.0 PPM H2S
CHANNEL OFF

Press the **UP** button.

23

0.0 PPM CL2
SETUP WARNING
0.0 PPM H2S
CHANNEL OFF

Press the **ENTER** button.

24

0.0 PPM CL2
WARN SET: 2.5
0.0 PPM H2S
CHANNEL OFF

Press the **ENTER** button.

25

0.0 PPM CL2
WARN SET: 2.5
0.0 PPM H2S
CHANNEL OFF

Press the **UP** button and scroll to **19.5**.

Press the **ENTER** button.

26

0.0 PPM CL2
WARN SET: 19.5
0.0 PPM H2S
CHANNEL OFF

Press the **UP** button.

27

0.0 PPM CL2
WARN RES: 2.0
0.0 PPM H2S
CHANNEL OFF

Press the **ENTER** button.

28

0.0 PPM CL2
WARN RES: 2.0
0.0 PPM H2S
CHANNEL OFF

Press the **UP** button and scroll to **19.9**.

Press the **ENTER** button.

29

0.0 PPM CL2
WARN RES: 19.9
0.0 PPM H2S
CHANNEL OFF

Press the **ESCAPE** button.

30

0.0 PPM CL2
SETUP WARNING
0.0 PPM H2S
CHANNEL OFF

Press the **UP** button.

31

0.0 PPM CL2
SETUP ALARM
0.0 PPM H2S
CHANNEL OFF

Press the **ENTER** button.

32

0.0 PPM CL2
ALARM SET: 5.0
0.0 PPM H2S
CHANNEL OFF

Press the **ENTER** button.

33

0.0 PPM CL2
ALARM SET: 5.0
0.0 PPM H2S
CHANNEL OFF

Press the **UP** button and scroll to **17.0**.

Press the **ENTER** button.

34

0.0 PPM CL2
ALARM SET: 17.0
0.0 PPM H2S
CHANNEL OFF

Press the **UP** button

Press the **UP** button.

35 0.0 PPM CL2
ALARM RES: 4.5
0.0 PPM H2S
CHANNEL OFF

Press the **ENTER** button.

36 0.0 PPM CL2
ALARM RES: 4.5
0.0 PPM H2S
CHANNEL OFF

Press the **UP** button and scroll to **17.5**.

Press the **ENTER** button.

37 0.0 PPM CL2
ALARM RES: 17.5
0.0 PPM H2S
CHANNEL OFF

Press the **ESCAPE** button.

38 0.0 PPM CL2
SETUP ALARM
0.0 PPM H2S
CHANNEL OFF

Press the **ESCAPE** button.

39 0.0 PPM CL2
CHANNEL MENU
0.0 PPM H2S
CHANNEL OFF

Press the **ESCAPE** button.

40 0.0 PPM CL2
SAVE SETUP? YES
0.0 PPM H2S
CHANNEL OFF

Press the **ENTER** button.

41 0.0 PPM CL2
SETUP SAVED
0.0 PPM H2S
CHANNEL OFF

Press the **ESCAPE** button.

42 0.0 PPM CL2
20.9 % O2
0.0 PPM H2S
CHANNEL OFF

This completes the programming example for **Channel 2**.

Programming Example 3

Four combustible gas sensor/transmitters are installed, operating and calibrated. The transmitter outputs are connected to channels 1 through 4 on a QuadScan II. Security/Password will not be used. Remote relays will be connected to a QuadScan II instrument. It becomes necessary due to false alarms that a **Zone** configuration should be applied to the system. The inputs from any 2 of the 4 sensor/transmitters that create a high alarm condition will activate the remote relay **Number 1**, providing the necessary corrective action. The first step is to establish the correct formula to achieve the required results. The following diagram shows the detector relationship to establish this formula.

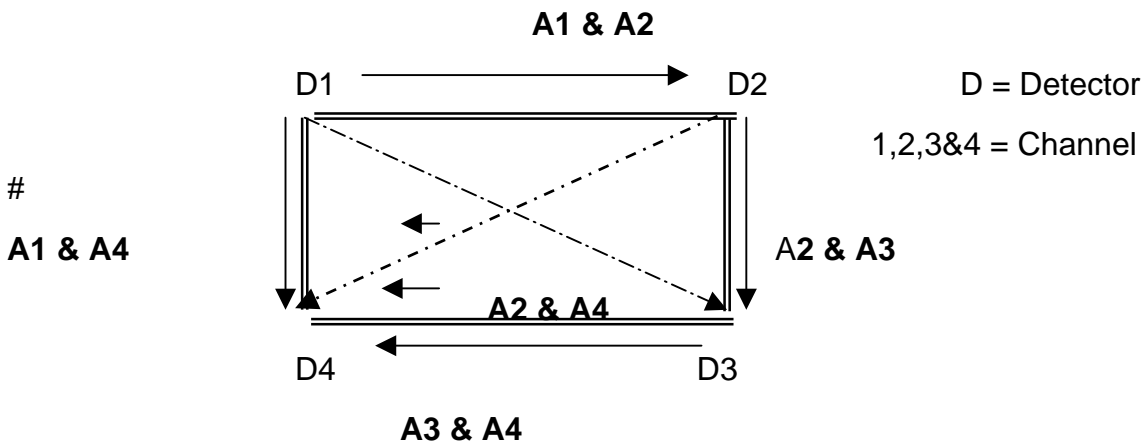

The programming formula derived is as follows:

$$(A1 \ \& \ A2) \ | \ (A2 \ \& \ A3) \ | \ (A2 \ \& \ A4) \ | \ (A3 \ \& \ A4) \ | \ (A1 \ \& \ A3) \ | \ (A1 \ \& \ A4)$$

The starting point to program the system for **Zoning** is as follows:

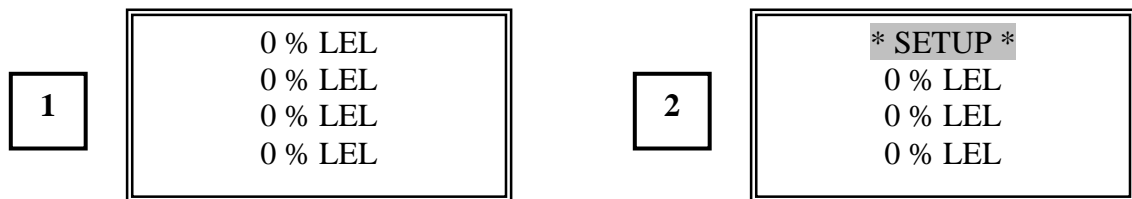

Press the **SETUP** button.

Press the **ENTER** button.

3

SECURITY MENU
0 % LEL
0 % LEL
0 % LEL

Press the **UP** button.

4

SYSTEM MENU
0 % LEL
0 % LEL
0 % LEL

Press the **ENTER** button.

5

VERSION *
0 % LEL
0 % LEL
0 % LEL

Press the **DOWN** button and scroll to **SET REMOTE RELAY**.

6

SET REMOTE RELAY
0 % LEL
0 % LEL
0 % LEL

Press the **ENTER** button.

7

RELAY: REM RLY 1
0 % LEL
0 % LEL
0 % LEL

Press the **ENTER** button.

8

FAILSAFE: NO
0 % LEL
0 % LEL
0 % LEL

Press the **ENTER** button.

9

W1
0 % LEL
0 % LEL
0 % LEL

Press the **UP** button and scroll to (.

Press the **SETUP** button.

10

(1
0 % LEL
0 % LEL
0 % LEL

Press the **DOWN** button and scroll to **A**.

11

(A
0 % LEL
0 % LEL
0 % LEL

Press the **SETUP** button. Press the **UP** button and scroll to 1.

12

(A1
0 % LEL
0 % LEL
0 % LEL

Press the **SETUP** button. Press the **UP** button and scroll to &.

13

(A1&
0 % LEL
0 % LEL
0 % LEL

***Current Software Version will be displayed.**

Press the **SETUP** button. Press the **UP** button and scroll to **A**.

14

(A1&A
0 % LEL
0 % LEL
0 % LEL

Press the **SETUP** button. Press the **UP** button and scroll to 2.

15

(A1&A2
0 % LEL
0 % LEL
0 % LEL

Press the **SETUP** button. Press the **UP** button and scroll to).

16

(A1&A2)
0 % LEL
0 % LEL
0 % LEL

Press the **SETUP** button. Press the **UP** button and scroll to |.

17

(A1&A2)
0 % LEL
0 % LEL
0 % LEL

Press the **SETUP** button. Press the **UP** button and scroll to (.

18 (A1&A2)|(

0 % LEL

0 % LEL

0 % LEL

Press the **SETUP** button. Press the **UP** button and scroll to A.

19 (A1&A2)|(A

0 % LEL

0 % LEL

0 % LEL

Press the **SETUP** button. Press the **UP** button and scroll to 2.

20 (A1&A2)|(A2

0 % LEL

0 % LEL

0 % LEL

Press the **SETUP** button then press the **UP** button and scroll to &.

21 (A1&A2)|(A2&

0 % LEL

0 % LEL

0 % LEL

Press the **SETUP** button then press the **UP** button and scroll to A.

22 (A1&A2)|(A2&A

0 % LEL

0 % LEL

0 % LEL

Press the **SETUP** button. Press the **UP** button and scroll to 3.

23 (A1&A2)|(A2&A3

0 % LEL

0 % LEL

0 % LEL

Press the **SETUP** button. Press the **UP** button and scroll to).

24 (A1&A2)|(A2&A3)

0 % LEL

0 % LEL

0 % LEL

Press the **SETUP** button. Press the **UP** button and scroll to |.

25 (A1&A2)|(A2&A3)|

0 % LEL

0 % LEL

0 % LEL

Press the **SETUP** button. Press the **UP** button and scroll to (.

26

A1&A2)|(A2&A3)|(

0 % LEL

0 % LEL

0 % LEL

Press the **SETUP** button. Press the **UP** button and scroll to **A**. **Note:** The display will now scroll to the right as only 16 positions are shown on the **LCD**.

27

1&A2)|(A2&A3)|(A

0 % LEL

0 % LEL

0 % LEL

Press the **SETUP** button. Press the **UP** button and scroll to **2**.

28

&A2)|(A2&A3)|(A2

0 % LEL

0 % LEL

0 % LEL

Press the **SETUP** button. Press the **UP** button and scroll to **&**.

29

A2)|(A2&A3)|(A2&

0 % LEL

0 % LEL

0 % LEL

Press the **SETUP** button

Press the **SETUP** button. Press the **UP** button and scroll to **A**.

30

2) |(A2&A3)|(A2&A

0 % LEL

0 % LEL

0 % LEL

Press the **SETUP** button. Press the **UP** button and scroll to **4**.

31

) |(A2&A3) |(A2&A4

0 % LEL

0 % LEL

0 % LEL

Press the **SETUP** button. Press the **UP** button and scroll to **)**.

32

| (A2&A3) |(A2&A4)

0 % LEL

0 % LEL

0 % LEL

Press the **SETUP** button. Press the **UP** button and scroll to **|**.

33

(A2&A3) |(A2&A4)|

0 % LEL

0 % LEL

0 % LEL

Press the **SETUP** button. Press the **UP** button and scroll to (.

34 A2&A3)|(A2&A4)|(
0 % LEL
0 % LEL
0 % LEL

Press the **SETUP** button then press the **UP** button and scroll to A.

35 2&A3) |(A2&A4)|(A
0 % LEL
0 % LEL
0 % LEL

Press the **SETUP** button. Press the **UP** button and scroll to 3.

36 &A3) |(A2&A4)|(A3
0 % LEL
0 % LEL
0 % LEL

Press the **SETUP** button. Press the **UP** button and scroll to &.

37 A3) |(A2&A4)|(A3&
0 % LEL
0 % LEL
0 % LEL

Press the **SETUP** button. Press the **UP** button and scroll to A.

38 3) |(A2&A4)|(A3&A
0 % LEL
0 % LEL
0 % LEL

Press the **SETUP** button. Press the **UP** button and scroll to 4.

39) |(A2&A4)|(A3&A4
0 % LEL
0 % LEL
0 % LEL

Press the **SETUP** button. Press the **UP** button and scroll to).

40 |(A2&A4)|(A3&A4)
0 % LEL
0 % LEL
0 % LEL

Press the **SETUP** button. Press the **UP** button and scroll to |.

41 (A2&A4)|(A3&A4)|
0 % LEL
0 % LEL
0 % LEL

Press the **SETUP** button. Press the **UP** button and scroll to (.

42

```
A2&A4)|(A3&A4)|(
0 % LEL
0 % LEL
0 % LEL
```

Press the **SETUP** button then press the **UP** button and scroll to A (.

43

```
2&A4)|(A3&A4)|(A
0 % LEL
0 % LEL
0 % LEL
```

Press the **SETUP** button. Press the **UP** button and scroll to 1.

44

```
&A4)|(A3&A4)|(A1
0 % LEL
0 % LEL
0 % LEL
```

Press the **SETUP** button then press the **UP** button and scroll to &.

45

```
A4)|(A3&A4)|(A1&
0 % LEL
0 % LEL
0 % LEL
```

Press the **SETUP** button. Press the **UP** button and scroll to A.

46

```
4)|(A3&A4)|(A1&A
0 % LEL
0 % LEL
0 % LEL
```

Press the **SETUP** button. Press the **UP** button and scroll to 3.

47

```
)|(A3&A4)|(A1&A3
0 % LEL
0 % LEL
0 % LEL
```

Press the **SETUP** button. Press the **UP** button and scroll to).

48

```
|(A3&A4)|(A1&A3)
0 % LEL
0 % LEL
0 % LEL
```

Press the **SETUP** button. Press the **UP** button and scroll to |.

49

```
(A3&A4)|(A1&A3)|
0 % LEL
0 % LEL
0 % LEL
```

Press the **SETUP** button. Press the **UP** button and scroll to (.

50

A3&A4) (A1&A3) (
0 % LEL
0 % LEL
0 % LEL

Press the **SETUP** button. Press the **UP** button and scroll to A.

54

) A1&A3) (A1&A
0 % LEL
0 % LEL
0 % LEL

Press the **SETUP** button. Press the **UP** button and scroll to A.

51

3&A4) (A1&A3) (A
0 % LEL
0 % LEL
0 % LEL

Press the **SETUP** button. Press the **UP** button and scroll to 4.

55

) (A1&A3) (A1&A4
0 % LEL
0 % LEL
0 % LEL

Press the **SETUP** button. Press the **UP** button and scroll to 1.

52

&A4) (A1&A3) (A1
0 % LEL
0 % LEL
0 % LEL

Press the **SETUP** button. Press the **UP** button and scroll to).

56

) (A1&A3) (A1&A4)
0 % LEL
0 % LEL
0 % LEL

Press the **SETUP** button. Press the **UP** button and scroll to &.

53

A4) (A1&A3) (A1&
0 % LEL
0 % LEL
0 % LEL

This concludes the programming for **Remote Relay 1**. All remote relays are programmed in the same manner.

Press the **ESCAPE** button.

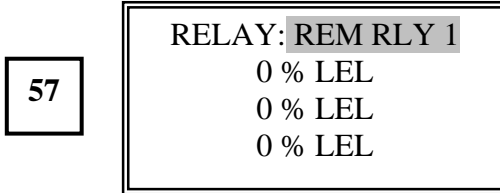

If you wish to program another remote relay press the **UP** button.

To return to the **Active Display**, press the **ESCAPE** button.

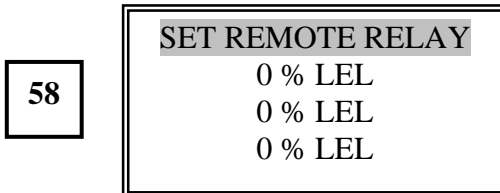

Press the **ESCAPE** button.

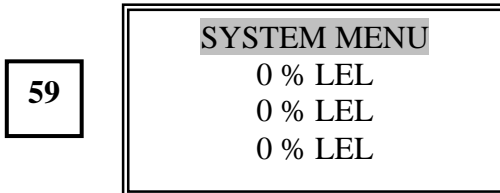

Press the **ESCAPE** button.

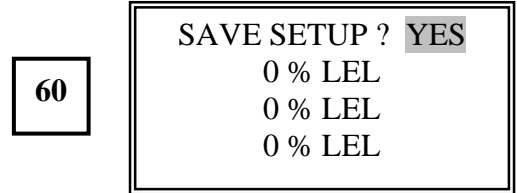

Press the **ENTER** button. This display is shown for 2 seconds.

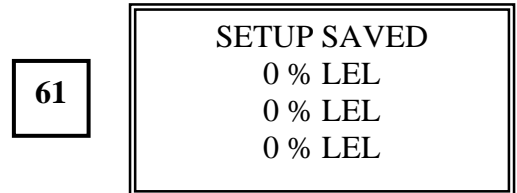

After the 2 second time out, the **Active Display** is shown.

