

ZANUSSI

REFRIGERATOR

ZI 9155 A

ZI 9225 A

INSTRUCTION BOOKLET



Important Safety Instructions

These warnings are provided in the interests of your safety. Ensure that you understand them all before installing or using this appliance. Your safety is of paramount importance. If you are unsure about any of the meanings of these warnings contact the Customer Care Department.

Prior to Installation

- Check the appliance for transport damage. Under no circumstance should a damaged appliance be installed. In the event of damage please contact your retailer.

Installation

- This appliance is heavy. Care should be taken when moving it.
- It is dangerous to alter the specifications or attempt to modify this product in any way.
- Ensure that the appliance does not stand on the electrical supply cable.
Important: if the supply cable is damaged, it must be replaced by a cable available from the manufacturer or your local Service Force Centre.
- Any electrical work required to install this appliance should be carried out by a qualified electrician or competent person.
- Parts which heat up should not be exposed. Whenever possible, the back of the appliance should be close to a wall, but leaving the required distance for ventilation, as stated in the installation instructions.
- The appliance should be left for 2 hours after installation before it is turned on, in order to allow the refrigerant to settle.

Refrigerant

- The refrigerant isobutane (R600a) is contained within the refrigerant circuit of the appliance, a natural gas with a high level of environmental compatibility, which is nevertheless flammable.
- During transportation and installation of the appliance, be certain that none of the components of the refrigerant circuit become damaged.
- If the refrigerant circuit should become damaged:
 - avoid open flames and sources of ignition.
 - thoroughly ventilate the room in which the appliance is situated.

Child Safety

- Do not allow children to tamper with the controls or play with the product.
- There is a risk of suffocation! Keep packaging material away from children!

General Safety

- **This appliance contains hydrocarbons in its cooling unit; maintenance and recharging must therefore only be carried out by authorised technicians.**
- **Take utmost care when handling your appliance so as not to cause any damages to the cooling unit with consequent possible fluid leakages.**
- **The appliance must not be located close to radiators or boilers.**
- **Avoid prolonged exposure of the appliance to direct sunlight.**
- **Do not use other electrical appliances (such as ice cream makers) inside of refrigerating appliances.**

During Use

- This appliance is designed for domestic use only, specifically for the storage of edible foodstuffs. It is not intended for commercial or industrial use.
- Containers with flammable gases or liquids can leak at low temperatures. Do not store any containers with flammable materials, such as spray cans, fire extinguisher refill cartridges etc. in the refrigerator.

Maintenance and Cleaning

- Before cleaning, always switch off the appliance and disconnect from the electrical supply.
- When unplugging always pull the plug from the mains socket, do not pull on the cable.

Servicing

- This product should be serviced by an authorised engineer and only genuine spare parts should be used.
- Under no circumstances should you attempt to repair the appliance yourself. Repairs carried out by inexperienced persons may cause injury or serious malfunctioning. Contact your local Service Force Centre.

At the end of the Appliance Life

- When disposing of your appliance use an authorised disposal site.



The symbol  on the product or on its packaging indicates that this product may not be treated as household waste. Instead it shall be handed over to the applicable collection point for the recycling of electrical and electronic equipment. By ensuring this product is disposed of correctly, you will help prevent potential negative consequences for the environment and human health, which could otherwise be caused by inappropriate waste handling of this product. For more detailed information about recycling of this product, please contact your local city office, your household waste disposal service or the shop where you purchased the product.

- Remove the plug and ensure that any locks or catches are removed, to prevent young children being trapped inside.

Contents

Instructions for the User

Important Safety Instructions	2
Operation	4
Before use / Setting the temperature	4
Fresh food refrigeration	4
The door shelves	4
Normal operating sounds	5
Health and safety guidelines	5
Defrosting	6
Maintenance and Cleaning	6
Internal cleaning / Changing the light bulb	6
Something not Working?	7
Service and Spare Parts	8
Customer Care Department	8
Guarantee Conditions	9

Instructions for the Installer

Technical specifications	10
Installation	10
Positioning	10
Door reversal	11
Electrical Connection	12
Building in	13

Operation

Before use

Remove all securing tapes. Wash inside the appliance with lukewarm water and bicarbonate of soda (5 ml to 0.5 litre of water). Do not use soap or detergent as the smell may linger. Dry thoroughly.

Setting the temperature

The temperature inside the refrigerator is regulated by a thermostat control knob with 6 temperature positions and one «OFF» (O) position.

Position 1 = minimum coldness

Position 6 = maximum coldness

Turn the thermostat control knob to the required position.

An intermediate position is usually the most suitable, although the temperature will be affected by:

- Room temperature
- How often the door is opened
- How much food is stored
- Position of the appliance

In determining the correct temperature control setting all these factors have to be considered and some experimentation may be necessary.

When altering the temperature setting, allow 24 hours for the temperature to stabilise before making further changes.



Important

During prolonged periods of abnormally hot weather, if the thermostat is set on too high a number, the cooling system may operate continuously and the fridge cooling plate may not defrost. Turning the knob to a lower number will cause the automatic defrosting to resume.

If you wish to return to a lower temperature, turn the thermostat knob to a higher number, however you should turn the setting lower occasionally to allow automatic defrosting.

Fresh food refrigeration

To obtain the best performance, do not store warm food or evaporating liquids in the refrigerator; do cover or wrap the food, particularly if it has a strong flavour.

Do not cover the shelves with any protective material, such as paper, cardboard or plastic, which could obstruct the air circulation.

To help you use your refrigerator correctly, here are some more useful hints:

Raw meat (beef, pork, lamb & chicken or poultry): wrap in polythene bags and place on top of the salad bin.

Meat can only be stored safely in this way for one or two days at the most.

Fruit & vegetables: these should be thoroughly cleaned and placed in the bottom salad bin.

Butter & cheese: these should be placed in special airtight containers or wrapped in aluminium foil or polythene bags to exclude as much air as possible.

Milk bottles: these should have a cap and should be stored in the bottle rack on the door.

The walls of the refrigerator are equipped with runners so that shelves can be positioned as desired.

For better use of space, the front half-shelves can lie over the rear ones (see fig.).

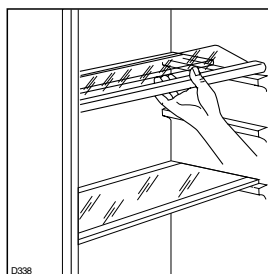

The door shelves

To permit storage of food packages of various sizes the central door shelf can be adjusted in height.

To do this proceed as figure.

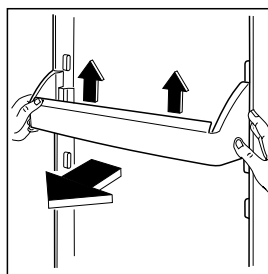

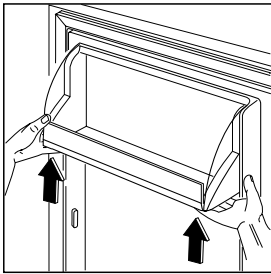

For more thorough cleaning, the top door shelf and the bottle shelf can be removed by pulling them in the direction of the arrows, then refitting them in position.

Normal operating sounds

You may hear faint gurgling or bubbling sounds when the refrigerant is pumped through the coils or tubing at the rear, to the cooling plate.

When the compressor is on, the refrigerant is being pumped round, and you will hear a whirring sound or pulsating noise from the compressor.

A thermostat controls the compressor, and you will hear a faint 'click' when the thermostat cuts in and out.

i Health and Safety Guidelines

Because of consumer demand, preservatives have been removed from many pre-prepared foods.

This together with the changes in shopping habits to a once-a-week shop, mean that safe handling and storage of food is even more important than ever.

The following tips should help you to ensure that the food in your home is in as perfect condition as possible.

- Keep the time between buying chilled food and placing it in your fridge as short as possible. Tests showed that the temperature of 1 litre of orange juice rose to 22°C in an hour between the supermarket and home. It then took 11 hours to get down to 7°C in the refrigerator.
- Keep the refrigerator door closed as much as possible.
- Do not push food together too much, try to allow air to circulate around each item.
- Cool cooked food as quickly as possible but do NOT place in the refrigerator until cool. (Leave food in a cool place in order that it can then be placed in the refrigerator as soon as possible).
- Do NOT mix raw and cooked meat, they must be in separate containers. Take care not to let the meat juices drip onto other food. If the meat does drip, remove everything and clean thoroughly.
- Do not store food uncovered.
- Remove suspect food from your refrigerator and clean the interior (see "Maintenance and Cleaning").
- Never allow spillages to dry and harden.
- Store eggs in the egg rack provided in the refrigerator door. Discard any broken or chipped eggs.
- Regularly check the refrigerator door seal to ensure that it is clean and free from debris.
- Always wash your hands with soapy water and dry them with a clean towel before handling food.
- Keep work surfaces clean and avoid cross contamination by not using the same work surface or knife, without washing them thoroughly in between.

Defrosting

The refrigerator automatically defrosts every time the compressor stops. The water is discharged, via the pipe, into a tray located at the back of the appliance above the compressor, where it evaporates.



Important

To avoid defrost water overflowing into the fridge, periodically clean the water discharge hole in the centre of the V shaped drip collector at the back of the refrigerator compartment behind the salad bin. Use the special cleaner provided which you will find already inserted into the discharge hole.

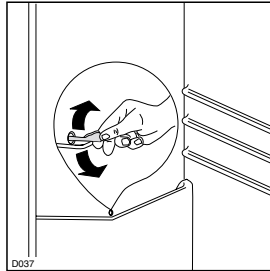

Maintenance and Cleaning



Warning

Before any maintenance or cleaning work is carried out, **DISCONNECT** the appliance from the **ELECTRICITY** supply.



Important

This appliance contains hydrocarbons in its cooling unit maintenance and recharging must therefore only be carried out by authorised technicians.

Internal cleaning

Clean the inside and accessories with warm water and bicarbonate of soda (5ml to 0.5 litre of water). Rinse and dry thoroughly.

NEVER USE DETERGENTS, ABRASIVE POWDERS, HIGHLY PERFUMED CLEANING PRODUCTS OR WAX POLISHES, TO CLEAN THE INTERIOR AS THESE WILL DAMAGE THE SURFACE AND LEAVE A STRONG SMELL.



Important

Do not use abrasive products.

Clean the drain hole of the water trough at regular intervals and make sure that the drain hole is never obstructed, so that the defrost water may flow freely.

Once or twice a year remove the ventilation grill and dust the air channels at the base of the appliance with a brush or vacuum cleaner.

You **MUST** ensure that the appliance is switched OFF. An accumulation of dust will affect the performance of the appliance and cause excessive electricity consumption.

Changing the light bulb

Should the interior light fail to work, first switch off the appliance and disconnect from the electricity supply, then replace the bulb as follows:

1. Unscrew the light cover and then pull it outward by pressing as shown in the figure.

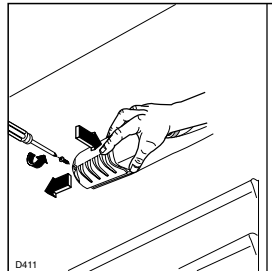

2. Unscrew the bulb and replace it with a new 15 watt bulb (available from your nearest Service Force Centre).
3. Replace the light cover by sliding it into its original position and replacing the screw.

When the appliance is not in use

When the appliance is not in use for long periods, disconnect from the electricity supply, empty all foods and clean the appliance, leaving the door ajar to prevent unpleasant smells.

Something not Working?

Before contacting your local Service Force Centre check the following points.

IMPORTANT: If you call out an engineer to a fault listed below, or to repair a fault caused by incorrect use or installation, a charge will be made even if the appliance is under guarantee.

Symptom	Solution
No power to appliance	<ul style="list-style-type: none"> - Check there is power at the socket. - Check there is not a power cut by checking the household lights. - Check the fuse has not blown.
The light does not come on	<ul style="list-style-type: none"> - Ensure that the bulb is correctly fitted. - Replace the bulb if it has blown. - Check the door light switch is not jammed.
The temperature in the fridge or freezer section is too high	<ul style="list-style-type: none"> - Check the ambient temperature is within the appliances operating limits of 10PC to 38PC. - Check the thermostat control knob is turned to the correct setting relative to ambient conditions.
The compressor runs continuously	<ul style="list-style-type: none"> - Adjust the thermostat control knob to give correct temperature control. See page 4. - Check that the door is closed. - Large quantities of food have recently been placed in the cabinet and/or door is frequently opened. - Check that air ventilation is not obstructed.
Excessive frost and ice has built up	<ul style="list-style-type: none"> - Ensure the door is not left open. - Check that nothing is preventing the door from closing. - Is the door gasket intact and clean.
Noise	<ul style="list-style-type: none"> - Refer to normal operating sounds.
Water under the salad bins	<ul style="list-style-type: none"> - Check the drain hole is not blocked. (see Maintenance and Cleaning).

If after the above checks, there is still a fault, call your local Service Force Centre.

In-guarantee customers should ensure that the above checks have been made as the engineer will make a charge if the fault is not a mechanical or electrical breakdown.

Please note that proof of purchase is required for any in-guarantee service calls.

Service and Spare Parts

SERVICEFORCE

In the event of your appliance requiring service, or if you wish to purchase spare parts, please contact your local Service Force Centre by telephoning:-

08705 929929

Your telephone call will be automatically routed to the Service Force Centre covering your post code area.

For the address of your local Service Force Centre and further information about Service Force, please visit the website at www.serviceforce.co.uk

Before calling out an engineer, please ensure you have read the details under the heading "Something Not Working."

When you contact the Service Force Centre you will need to give the following details:

1. Your name, address and post code
2. Your telephone number
3. Clear and concise details of the fault
4. The model and serial number of the appliance (found on the rating plate)
5. The purchase date

Please note that a valid purchase receipt or guarantee documentation is required for in-guarantee service calls.

For Customer Service in Ireland please contact us at the address below:

Zanussi
Electrolux Group (Irl) Ltd
Long Mile Road
Dublin 12
Republic of Ireland

Tel: + 353 1 4090751

Email: service.eid@electrolux.ie

Customer Care Department

For general enquiries concerning your Zanussi appliance or for further information on Zanussi products, please contact our Customer Care Department by letter or telephone at the address below or visit our website at www.zanussi.co.uk

Customer Care Department
Major Appliances
Zanussi
Addington Way
Luton
Bedfordshire
LU4 9QQ
Tel: 08705 727 727 (*)

* calls to this number may be recorded for training purposes.

Guarantee Conditions

Standard guarantee conditions

We, Zanussi, undertake that if within 24 months of the date of purchase this Zanussi appliance or any part thereof is proved to be defective by reason only of faulty workmanship or materials, we will, at our option repair or replace the same FREE OF CHARGE for labour, materials or carriage on condition that:

- The appliance has been correctly installed and used only on the electricity supply stated on the rating plate.
- The appliance has been used for normal domestic purposes only, and in accordance with the manufacturer's instructions.
- The appliance has not been serviced, maintained repaired, taken apart or tampered with by any person not authorised by us.
- All service work under this guarantee must be undertaken by a Service Force Centre.
- Any appliance or defective part replaced shall become the Company's property.
- This guarantee is in addition to your statutory and other legal rights.

Home visits are made between **8.30am** and **5.30pm** Monday to Friday. Visits may be available outside these hours in which case a **premium** will be charged.

Exclusions

This guarantee does not cover:

- Damage or calls resulting from transportation, improper use or neglect, the replacement of any light bulbs or removable parts of glass or plastic.
- Costs incurred for calls to put right an appliance which is improperly installed or calls to appliances outside the United Kingdom.
- Appliances found to be in use within a commercial environment, plus those which are subject to rental agreements.
- Products of Zanussi manufacture which are not marketed by Zanussi.

European Guarantee

If you should move to another country within Europe then your guarantee moves with you to your new home subject to the following qualifications:

- The guarantee starts from the date you first purchased your product.
- The guarantee is for the same period and to the same extent for labour and parts as exists in the new country of use for this brand or range of products.
- This guarantee relates to you and cannot be transferred to another user.
- Your new home is within European Community (EC) or European Free Trade Area.
- The product is installed and used in accordance with our instructions and is only used domestically, i.e. a normal household.
- The product is installed taking into account regulations in your new country.

Before you move please contact your nearest Customer Care centre, listed below, to give them details of your new home. They will then ensure that the local Service Organisation is aware of your move and able to look after you and your appliance.

France	Senlis	+33 (0) 3 44 62 29 29
Germany	Nürnberg	+49 (0) 800 234 7378
Italy	Pordenone	+39 (0) 0434 39 4700
Sweden	Stockholm	+46 (0) 8 672 53 90
UK	Luton	+44 (0) 8705 727727
Ireland	Dublin	+353 (0) 1 4090751

Technical specifications

	ZI 9155 A	ZI 9225 A
POWER SUPPLY VOLTAGE AND FREQUENCY	220-240 V / 50 Hz	220-240 V / 50 Hz
TOTAL POWER ABSORBED	110 W	140 W
AVERAGE DAILY UNITS ELECTRICITY (*)	0,41 kWh	0,44 kWh
GROSS CAPACITY	158 l	230 l
NET CAPACITY	154 l	228 l

(*) This figure is based on standard test results in accordance with European Standard EN153. Actual consumption will depend on how the appliance is used and where it is located.

Installation



Warning

IF YOU ARE DISCARDING AN OLD APPLIANCE THAT HAS A LOCK OR CATCH ON THE DOOR, YOU MUST ENSURE THAT IT IS MADE UNUSABLE TO PREVENT YOUNG CHILDREN BEING TRAPPED INSIDE.

Depending upon the position which you choose for your appliance, you may wish to reverse the way in which the door opens. To do this, refer to instructions under "Door reversal".

Positioning

The appliance should only be installed at a location where the ambient temperature corresponds to the climate classification indicated on the rating plate, which is located on the inside left of the appliance.

The following table shows which ambient temperature is correct for each climate classification.

SN	+10°C to +32°C
ST	+18°C to +38°C

The appliance should be located in a dry atmosphere, out of direct sunlight and away from continuous heat and extreme temperature, e.g. not next to a boiler or radiator or in a very cold room e.g. an outhouse. If these temperatures are exceeded i.e. warmer or colder, then the appliance may not operate correctly.

For building-in and door reversal instructions please refer to the relevant instructions on the following pages.



Important

It must be possible to disconnect the appliance from the mains power supply; the plug must therefore be easily accessible after installation.

Door reversal

The appliance's door has been locked in position for transport by means of pins on both sides. According to the door opening direction, remove the relevant pins at the top and at the bottom.



Attention

After completion of the door reversing operation, check that the door gasket adheres to the cabinet. If the ambient temperature is cold (i.e. in Winter), the gasket may not fit perfectly to the cabinet. In that case, wait for the natural fitting of the gasket or accelerate this process by heating up the part involved with a normal hairdryer on a low setting.

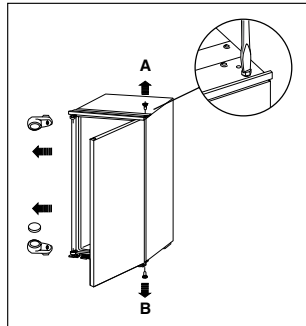

Electrical Connection

WARNING
THIS APPLIANCE MUST BE EARTHED.
The manufacturer declines any liability should this safety measure not be observed.

If the plug that is fitted to your appliance is not suitable for your socket outlet, it must be cut off and the appropriate plug fitted.

Remove the fuse from the cut off plug.

The cut off plug should then be disposed of to prevent the hazard of shocks in case it should be plugged into a 13amp socket in another part of your home.

Important
The wires in the mains lead are coloured in accordance with the following code:

Green and Yellow - Earth

Blue - Neutral

Brown - Live

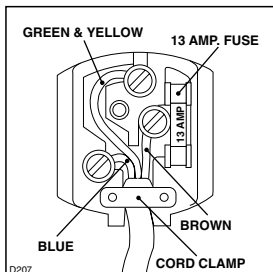

If you fit your own plug, the colours of the wires in the mains lead of your appliance, may not correspond with the markings identifying the terminals in your plug, proceed as follows:

Connect the Green and the Yellow (earth) wire to the terminal in the plug which is marked with the letter «E» or the earth symbol \oplus , or coloured green and yellow.

Connect the blue (neutral) wire to the terminal in the plug which is marked with the letter «N» or coloured black.

Connect the brown (live) wire to the terminal in the plug which is marked with the letter «L» or coloured red.

The plug moulded onto the lead incorporates a fuse. For replacement, use a 13amp BS1362 fuse. Only ASTA or BSI approved fuses should be used.

The plug must not be used if the fuse cover/carrier is lost. The cover/carrier is indicated by the coloured insert at the base of the plug.

This appliance complies with the following E.E.C. Directive:

- CE** -73/23 EEC of 19.2.73 (Low Voltage Directive) and subsequent amendments.
- 87/308 of 2.6.87 (Radio Interference Suppression) and subsequent amendments.
- 89/336 EEC of 3.5.89 (Electromagnetic Compatibility Directive) and subsequent amendments.

Please ensure that when the appliance is installed it is easily accessible for the engineer in the event of breakdown.

Building in

Dimensions of the recess

	ZI 9155 A	ZI 9225 A
Height of housing (1)	mm 880	1225
Depth of housing (2)	mm 550	550
Width of housing (3)	mm 560	560

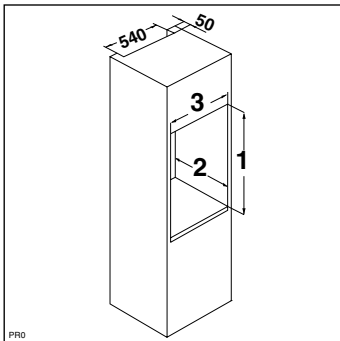

It is necessary that the cabinet has a ventilation recess with the following dimensions:

Depth 50 mm Width 540 mm

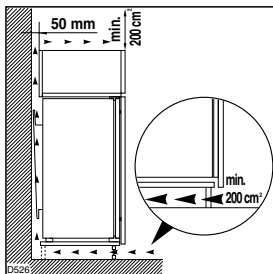

For appropriate venting, follow indications in the figure.

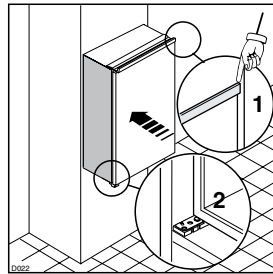

1. Fit the appliance in the niche by making sure that it stands against the interior surface of the unit on the side where the door hinges of the appliances are fitted. Insert the appliance until the upper strip butts up against the unit (1) and make sure that the lower hinge is in line with the surface of the unit (2).

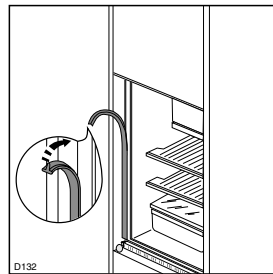

2. Press in the joint covers between the appliance and the kitchen furniture.

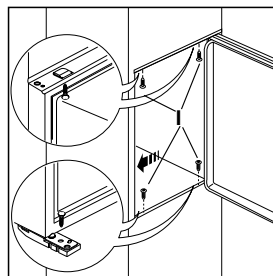

3. Open the door and push the appliance against the side of kitchen furniture opposite to that of the appliance hinges. Fasten the appliance with 4 screws (I) provided in the kit included with the appliance.

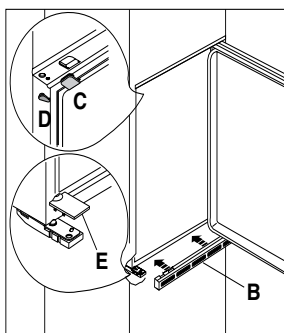

4. Snap vent grill (B) and hinge cover (E) into position.
Apply blanking covers (C-D) as indicated.

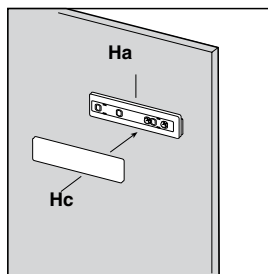

7. Fix cover (Hc) on guide (Ha) until it clips into place.

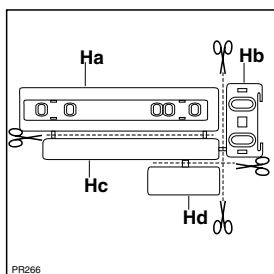

5. Separate parts Ha, Hb, Hc, Hd as shown in the figure.

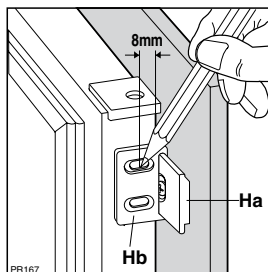

8. Open the appliance door and the furniture door at 90°. Insert the small square (Hb) into guide (Ha). Put together the appliance door and the furniture door and mark the holes as indicated in the figure.

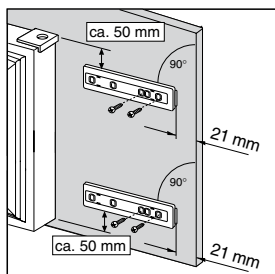

6. Place guide (Ha) on the inside part of the furniture door, up and down as shown in the figure and mark the position of external holes. After having drilled holes, fix the guide with the screws supplied.

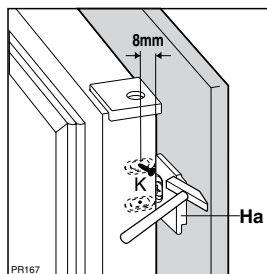

9. Remove the squares and mark a distance of 8 mm from the outer edge of the door where the nail must be fitted (K).

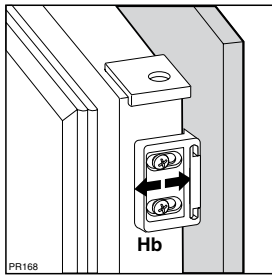

10. Place the small square on the guide again and fix it with the screws supplied.
Should the [alignment](#) of the furniture door be necessary, use the clearance of slots.
At the end of [this procedure](#), it is necessary to check if the door of the furniture closes properly.

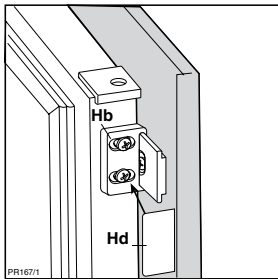

11. Fix cover ([Hd](#)) on [the small square \(Hb\)](#) until it clips into place.

 **From the Electrolux Group.** *The world's No.1 choice.*

The Electrolux Group is the world's largest producer of powered appliances for kitchen, cleaning and outdoor use. More than 55 million Electrolux Group products (such as refrigerators, cookers, washing machines, vacuum cleaners, chain saws and lawn mowers) are sold each year to a value of approx. USD 14 billion in more than 150 countries around the world.