

# **USER'S MANUAL**

## **OMNUC SMARTSTEP SERIES/ W SERIES**

WMON Win Ver2.0

MONITORING SOFTWARE for SERVO DRIVER and MOTOR

## **ABOUT THIS MANUAL:**

This manual describes the specifications and operation of WMON Win Ver.2.0, the monitoring software for servo driver and motor. Please read this manual carefully and understand it thoroughly for correct use. Refer to the user's manual of the applicable servo driver and motor as needed.

### **1. Intended Audience**

This manual is intended for the following personnel, who must also have knowledge of electrical systems (an electrical engineer or the equivalent).

- Personnel in charge of installing FA systems.
- Personnel in charge of designing FA systems.
- Personnel in charge of managing FA systems and facilities

### **2. General Precautions**

The user must operate the product according to the performance specifications described in the operation manuals.

Before using the product under conditions which are not described in the manual or applying the product to nuclear control systems, railroad systems, aviation systems, vehicles, combustion systems, medical equipment, amusement machines, safety equipment, and other systems, machines, and equipment that may have a serious influence on lives and property if used improperly, consult your OMRON representative.

This manual provides information that is required for the use of WMON Win Ver. 2.0, the monitoring software for OMNUC SMARTSTEP SERIES/W SERIES. Please read this manual carefully and understand it thoroughly. Also, always keep this manual close at hand for reference.

## ***Read and Understand this Manual***

Please read and understand this manual before using the product. Please consult your OMRON representative if you have any questions or comments.

## ***Warranty and Limitations of Liability***

### ***WARRANTY***

OMRON's exclusive warranty is that the products are free from defects in materials and workmanship for a period of one year (or other period if specified) from date of sale by OMRON.

OMRON MAKES NO WARRANTY OR REPRESENTATION, EXPRESS OR IMPLIED, REGARDING NON-INFRINGEMENT, MERCHANTABILITY, OR FITNESS FOR PARTICULAR PURPOSE OF THE PRODUCTS. ANY BUYER OR USER ACKNOWLEDGES THAT THE BUYER OR USER ALONE HAS DETERMINED THAT THE PRODUCTS WILL SUITABLY MEET THE REQUIREMENTS OF THEIR INTENDED USE. OMRON DISCLAIMS ALL OTHER WARRANTIES, EXPRESS OR IMPLIED.

### ***LIMITATIONS OF LIABILITY***

OMRON SHALL NOT BE RESPONSIBLE FOR SPECIAL, INDIRECT, OR CONSEQUENTIAL DAMAGES, LOSS OF PROFITS OR COMMERCIAL LOSS IN ANY WAY CONNECTED WITH THE PRODUCTS, WHETHER SUCH CLAIM IS BASED ON CONTRACT, WARRANTY, NEGLIGENCE, OR STRICT LIABILITY.

In no event shall the responsibility of OMRON for any act exceed the individual price of the product on which liability is asserted.

IN NO EVENT SHALL OMRON BE RESPONSIBLE FOR WARRANTY, REPAIR, OR OTHER CLAIMS REGARDING THE PRODUCTS UNLESS OMRON'S ANALYSIS CONFIRMS THAT THE PRODUCTS WERE PROPERLY HANDLED, STORED, INSTALLED, AND MAINTAINED AND NOT SUBJECT TO CONTAMINATION, ABUSE, MISUSE, OR INAPPROPRIATE MODIFICATION OR REPAIR.

## ***Application Considerations***

### ***SUITABILITY FOR USE***

OMRON shall not be responsible for conformity with any standards, codes, or regulations that apply to the combination of products in the customer's application or use of the products.

At the customer's request, OMRON will provide applicable third party certification documents identifying ratings and limitations of use that apply to the products. This information by itself is not sufficient for a complete determination of the suitability of the products in combination with the end product, machine, system, or other application or use.

The following are some examples of applications for which particular attention must be given. This is not intended to be an exhaustive list of all possible uses of the products, nor is it intended to imply that the uses listed may be suitable for the products:

- Outdoor use, uses involving potential chemical contamination or electrical interference, or conditions or uses not described in this manual.
- Nuclear energy control systems, combustion systems, railroad systems, aviation systems, medical equipment, amusement machines, vehicles, safety equipment, and installations subject to separate industry or government regulations.
- Systems, machines, and equipment that could present a risk to life or property.

Please know and observe all prohibitions of use applicable to the products.

**NEVER USE THE PRODUCTS FOR AN APPLICATION INVOLVING SERIOUS RISK TO LIFE OR PROPERTY WITHOUT ENSURING THAT THE SYSTEM AS A WHOLE HAS BEEN DESIGNED TO ADDRESS THE RISKS, AND THAT THE OMRON PRODUCTS ARE PROPERLY RATED AND INSTALLED FOR THE INTENDED USE WITHIN THE OVERALL EQUIPMENT OR SYSTEM.**

### ***PROGRAMMABLE PRODUCTS***

OMRON shall not be responsible for the user's programming of a programmable product, or any consequence thereof.

## ***Disclaimers***

### ***CHANGE IN SPECIFICATIONS***

Product specifications and accessories may be changed at any time based on improvements and other reasons.

It is our practice to change model numbers when published ratings or features are changed, or when significant construction changes are made. However, some specifications of the products may be changed without any notice. When in doubt, special model numbers may be assigned to fix or establish key specifications for your application on your request. Please consult with your OMRON representative at any time to confirm actual specifications of purchased products.

### ***DIMENSIONS AND WEIGHTS***

Dimensions and weights are nominal and are not to be used for manufacturing purposes, even when tolerances are shown.

### ***PERFORMANCE DATA***

Performance data given in this manual is provided as a guide for the user in determining suitability and does not constitute a warranty. It may represent the result of OMRON's test conditions, and the users must correlate it to actual application requirements. Actual performance is subject to the OMRON Warranty and Limitations of Liability.

### ***ERRORS AND OMISSIONS***

The information in this manual has been carefully checked and is believed to be accurate; however, no responsibility is assumed for clerical, typographical, or proofreading errors, or omissions.



**OMRON**

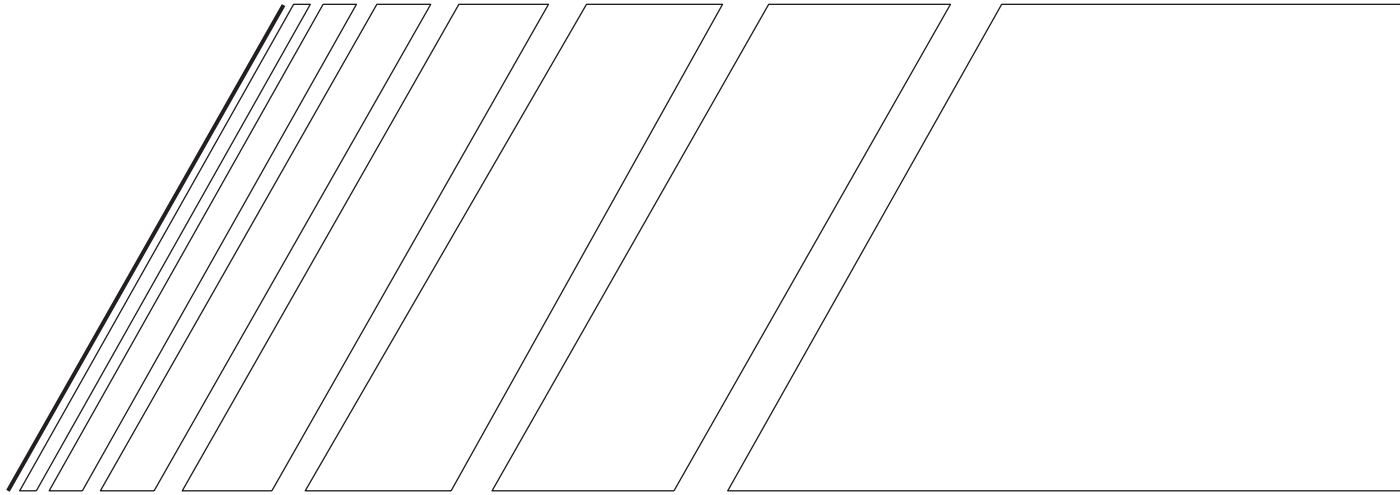

**USER'S MANUAL**

**OMNUC SMARTSTEP SERIES/  
W SERIES**

WMON Win Ver2.0

MONITORING SOFTWARE for SERVO DRIVER and MOTOR

## **Notice:**

OMRON products are manufactured for use according to proper procedures by a qualified operator and only for the purposes described in this manual.

The following conventions are used to indicate and classify precautions in this manual. Always heed the information provided with them. Failure to heed precautions can result in injury to people or damage to property.

 **WARNING** Indicates a potentially hazardous situation which, if not avoided, could result in death or serious injury.

 **Caution** Indicates a potentially hazardous situation which, if not avoided, may result in minor or moderate injury, or property damage.

## **OMRON Product References**

All OMRON products are capitalized in this manual. The word "Unit" is also capitalized when it refers to an OMRON product, regardless of whether or not it appears in the proper name of the product.

The abbreviation "Ch," which appears in some displays and on some OMRON products, often means "word" and is abbreviated "Wd" in documentation in this sense.

The abbreviation "PLC" means Programmable Controller. The abbreviation "PC," however, is used in some Programming Device displays to mean Programmable Controller.

## **Visual Aids**

The following headings appear in the left column of the manual to help you locate different types of information.

**Note** Indicates information of particular interest for efficient and convenient operation of the product.

### **© OMRON, 2003**

All rights reserved. No part of this publication may be reproduced, stored in a retrieval system, or transmitted, in any form, or by any means, mechanical, electronic, photocopying, recording, or otherwise, without the prior written permission of OMRON.

No patent liability is assumed with respect to the use of the information contained herein. Moreover, because OMRON is constantly striving to improve its high-quality products, the information contained in this manual is subject to change without notice. Every precaution has been taken in the preparation of this manual. Nevertheless, OMRON assumes no responsibility for errors or omissions. Neither is any liability assumed for damages resulting from the use of the information contained in this publication.





## ■ STARTING MULTI-AXIS COMMUNICATIONS

 **Caution** Set a unique unit No. for each Unit. If the same unit No. is set for more than one Unit and communications with a personal computer are started, the driver or personal computer may be damaged.

- \*1 When using multi-axis communications, set the unit No. for each driver before connecting to the personal computer.
- \*2 In multi-axis communications, set the unit No. selecting from 1 to E (14) and F (15). Do not use the unit No. 0.
- \*3 Unit No. setting is not needed for UE. (Multi-axis communications cannot be established.) For SMARTSTEP and UT, set the unit No. using the rotary switch on the front panel.

## ■ TRANSFERRING PARAMETERS TO DRIVER

 **Caution** Double-check that the assigned unit Nos. are correct before transferring parameters to the driver. Transferring parameters to the driver with incorrect unit Nos. may cause unexpected operation or damage to the equipment.

## ■ WIRING

 **Caution** Turn OFF the power to both the Servo Driver and personal computer before connecting or disconnecting cables. Not doing so may cause damage to the equipment.

 **Caution** Do not change cable connections while the monitoring software is operating. Otherwise, the equipment may be damaged or malfunction.

## ■ OPERATION

 **Caution** Always exit the personal computer's monitoring software before turning ON/OFF the power supply to the Servo Driver. Not doing so may cause damage to the equipment.

 **Caution** Check that people or obstructions are not in the vicinity of the motor or machinery when using the Jogging operation. Also, do not connect or disconnect cables, interrupt the personal computer's monitoring software operation, or turn OFF the personal computer during operation. Otherwise, the equipment may be damaged.

## ■ REFERENCE MANUALS

Related user's manuals are as follows. When using Monitoring software, refer to the user's manuals of applicable products as needed. For information on the manuals, please consult our sales representative.

Name	Cat. No.
OMNUC SMARTSTEP A SERIES Servomotors/Servo Drivers USER'S MANUAL	I533-E1-01
OMNUC SMARTSTEP A SERIES Servomotors/Servo Drivers OPERATION MANUAL	I534-E1-01
OMNUC W SERIES AC SERVOMOTORS/SERVO DRIVERS USER'S MANUAL	I531-E1-03

## ■ NOTATION

In this manual, the following conventions are used to describe screen messages and mouse/keyboard operations.

Names of menus and menu items are indicated in bold italic, e.g., the ***File*** Menu.

Names of keys and buttons are indicated in bold (usually followed by "Key" or "Button"), e.g., **Tab** Key and **OK** Button.

Dialog boxes and window names are indicated with capitalization, e.g., the Search Dialog Box.

The levels of items in menu hierarchies are distinguished with slashes. For example, "Select ***File/New***" tells the reader to select ***New*** from the ***File*** Menu.

The "+" sign is used to indicate that keys are pressed simultaneously. For example, "Press the **Ctrl+S** Keys" tells the reader to press the S Key while holding down the **Ctrl** Key.

"Click/Double-Click" indicates left click/left double-click. "Right Click" is particularly mentioned.

# Table of Contents

---

<b>Chapter 1. OVERVIEW</b> .....	<b>1-1</b>
1-1 WHAT IS "WMON Win Ver. 2.0"? .....	1-2
1-2 FEATURES .....	1-3
1-3 DATA CREATED WITH WMON Win Ver. 2.0 .....	1-5
<b>Chapter 2. SETUP</b> .....	<b>2-1</b>
2-1 INSTALLING/UNINSTALLING WMON .....	2-2
2-2 CONNECTING WITH PERSONAL COMPUTER .....	2-5
<b>Chapter 3. BASIC OPERATION</b> .....	<b>3-1</b>
3-1 START/QUIT .....	3-2
<b>Chapter 4. OPERATION METHOD</b> .....	<b>4-1</b>
4-1 COMMUNICATIONS SETTINGS .....	4-2
4-2 DRIVER CONNECTION AND DISCONNECTION .....	4-3
4-3 PARAMETER EDIT/SAVE/TRANSFER .....	4-4
4-4 MONITOR .....	4-9
4-5 ALARM .....	4-10
4-6 JOGGING/MOTOR ORIGIN SEARCH .....	4-11
<b>Revision History</b> .....	<b>R-1</b>

# Table of Contents

---

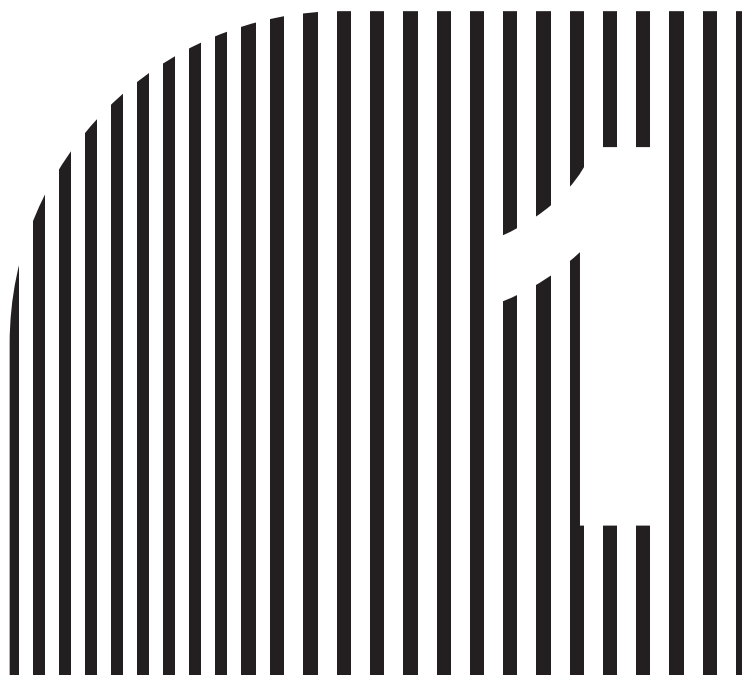

# Chapter 1

## OVERVIEW

- 1-1 WHAT IS "WMON Win Ver. 2.0"?
- 1-2 FEATURES
- 1-3 DATA CREATED WITH WMON Win Ver. 2.0

**1-1 WHAT IS "WMON Win Ver. 2.0"?**

WMON Win Ver. 2.0, the monitoring software for OMNUC SMARTSTEP SERIES/W SERIES, is the computer program that enables the personal computer to:

- Edit parameters
- Execute system check mode
- Perform jogging
- Check servo driver status
- Display waveforms of speed, torque, and I/O signals

Operations mentioned above can be performed with ease.

**■ APPLICABLE SERVO DRIVER**

WMON Win Ver. 2.0 can be used with the following servo drivers:

- 1.R7D-AP\*\*H/-AP\*\*L
- 2.R88D-WT\*\*H/-WT\*\*HL

**■ APPLICABLE PERSONAL COMPUTER**

WMON Win Ver. 2.0 can be used on computers that satisfy the following conditions:

Item	Requirement
Computer	IBM PC/AT or equivalent
OS	Windows 95 OSR2 or later Windows 98/Me Windows NT 4.0 SP3 or later Windows 2000
CPU	Pentium 133 MHz or higher
Memory	32 Mbytes min. (64 Mbytes or larger recommended)
Hard disk drive	50 Mbytes min. (100 Mbytes or larger available memory recommended when installing)
Screen resolution	SVGA (800 × 600 pixels) min.
Screen colors	256 colors min. (65536 or more recommended)
CD-ROM drive	1 min.
Communications port	RS232 or RS422 1 port min.

---

## 1-2 FEATURES

---

### ■ EDIT PARAMETER

- Parameters edited with the personal computer can be transferred to the servo driver.
- Parameters set on the servo driver can be saved to disks (FD, HD, etc.)
- Parameters saved in the disc can be read.
- Parameters can be changed real-time. Operationality in gain adjustment, etc. has been improved.

### ■ EXECUTE SYSTEM CHECK MODE

- Settings and results of online auto-tuning can be saved.
- Analog monitor output and motor current detection offset can be adjusted.
- Motor origin search can be performed.
- Password can be set.
- Speed and torque command offset can be adjusted. (Only with W SERIES)
- Absolute encoder can be set up (initialized). (Only with W SERIES)

### ■ JOGGING

- Jogging of the servomotor can be performed. (Jog speed and rotation direction can be specified using the personal computer.)

### ■ CHECK SERVO DRIVER STATUS

- Status (ON/OFF) of the servo driver's I/O signals can be checked.
- Internal status of the servo driver can be checked.
- Speed feedback, torque command, etc. can be monitored.
- Alarms being detected by the servo driver can be checked.

### ■ DISPLAY SPEED/TORQUE WAVEFORM

- Longitudinal data, such as torque command, speed command, speed feedback, position deviation, etc., can be imported and displayed.
- Status (ON/OFF) of the I/O signals can be imported as longitudinal data and displayed.
- Sampling time can be set as desired in the unit of 250  $\mu$ s.
- Imported data can be saved on the disk.
- Waveforms can be output to the printer.

### ■ MULTI-AXIS COMMUNICATIONS

- 1 computer can communicate with up to 15 servo drivers.



**■ INITIALIZE PARAMETER**

- Parameters can be set back to their default settings.

**■ INSTALL JAPANESE/ENGLISH**

- Program software of either Japanese or English version can be installed.

---

### 1-3 DATA CREATED WITH WMON Win Ver. 2.0

---

Files created and managed with WMON Win Ver. 2.0 are as follows:

Name	Extension	Content
Parameter file	.usr	Parameter files saved with WMON Win Ver. 2.0
Waveform trace file	.ysm	Trace files of waveform monitoring saved with WMON Win Ver. 2.0

The following files saved with UMON (monitoring software for MS-DOS) and WMON Win Ver. 1.0 cannot be read, edited, or saved with WMON Win Ver. 2.0.

Name	Extension	Content
Parameter file	.ysp	Parameter files saved with WMON Win Ver. 1.0
Waveform trace file	.ysm	Trace files of waveform monitoring saved with WMON Win Ver. 1.0
Parameter file	.ual	Parameter files for: R88D-UA**HA/-UA**LA/-UA**V/-UA**W R88D-UP**HA/-UP**LA/-UP**V/-UP**W
Parameter file	.uep	Parameter files for: R88D-UEP**H/-UEP**L/-UEP**V/-UEP**W
Parameter file	.uth	Parameter files for: R88D-UT**H/-UT**V (1 to 5 kW)

To use the parameters for W SERIES saved with WMON Win Ver. 1.0, transfer them to the driver with WMON Win Ver. 1.0 first, and read, edit, and save them with WMON Win Ver. 2.0. Files for U SERIES cannot be used with WMON Win Ver. 2.0. Use them with WMON Win Ver. 1.0





## Chapter 2

### SETUP

- 2-1 INSTALLING/UNINSTALLING WMON
- 2-2 CONNECTING WITH PERSONAL COMPUTER

## 2-1 INSTALLING/UNINSTALLING WMON

### ■ INSTALLING WMON

Start WMON Win Install Program to install WMON Win Ver. 2.0. The Install Program has WMON Win Program and Related files.

Start installation after quitting all the other running programs.

Installation of the program will proceed in the following order.

1. Switch ON the personal computer and start Windows.
2. Insert the CD-ROM into the CD-ROM drive.
  - Start "Setup.exe" in "WMON Win" Folder on the CD-ROM.
  - Start Explorer, select and start "Setup.exe" in "WMON Win" on the CD-ROM.

The following dialog box will be displayed.



3. Click the **English** Button for English version. And click the **Install** Button. (To install Japanese version, click the **Japanese** Button.)

The following dialog box will be displayed.

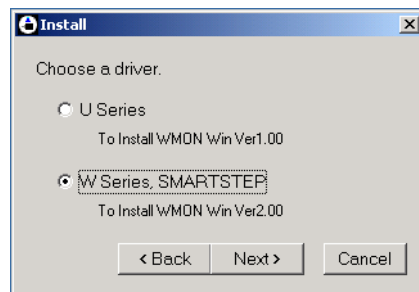

4. Select "W SERIES".

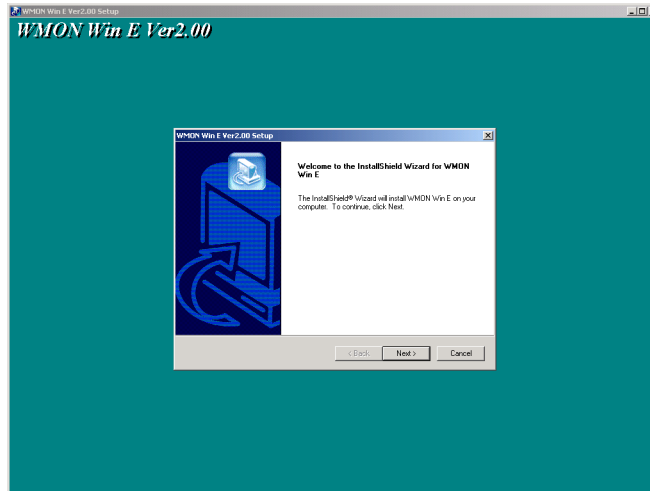

Read the content and click the **Next** Button. The following dialog box will be displayed.

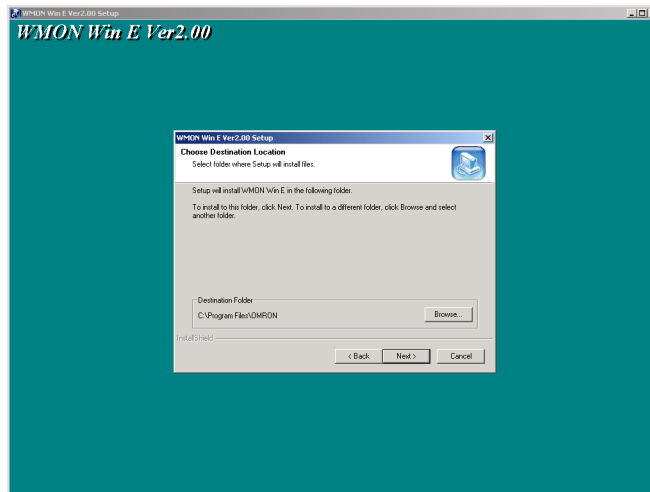

5. Select a folder in which WMON Win will be installed and click the **Next** Button. The following dialog box will be displayed.

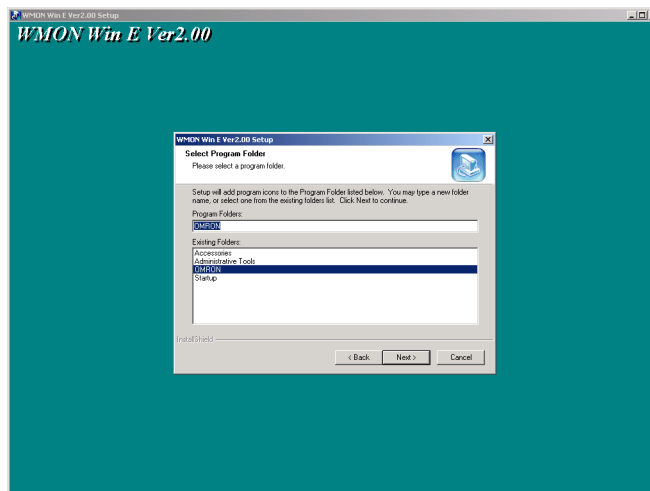

6. Select a program group that will create icons for WMON Win. The default setting is "WMON Win E". After selecting the group, click the **Next** Button. Install program will start. The file will be copied from the CD-ROM to the personal computer. Install status will be displayed.

Once the installation is completed, the following dialog box will be displayed.

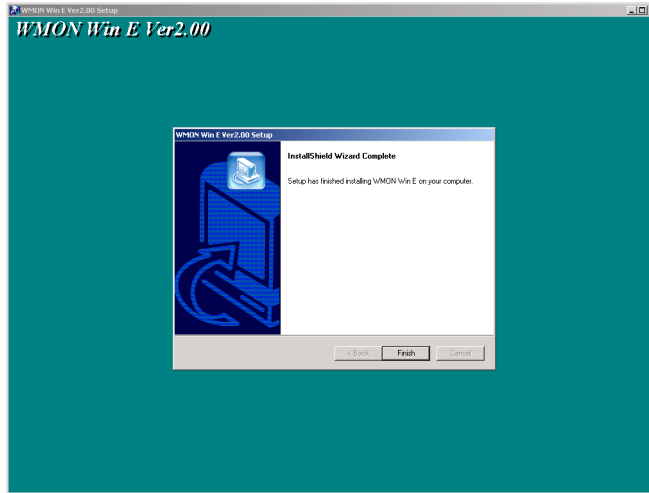

7. Click the **Finish** Button.

**■ UNINSTALLING WMON**

To remove WMON Win Ver. 2.0 from the personal computer, follow the procedures below:

1. Click **Start** in the taskbar, and point **Setting** with the cursor.
2. Click **Control Panel**.
3. Double-click on "Add/Remove Programs" Icon.
4. Add/Remove Programs Dialog Box will be displayed. Select "**WMON Win E**" from the list of "Change or Remove Programs" and click the **Change/Remove** Button.
5. Click the **OK** Button in the confirmation dialog box. WMON Win Ver. 2.0 will be removed from the personal computer.

## 2-2 CONNECTING WITH PERSONAL COMPUTER

To transfer parameters created with WMON Win Ver. 2.0 to a servo driver, a personal computer has to be connected to the servo driver with the cables mentioned below, and online communications have to be established.

### ■ CONNECTION FORMAT

#### ● With SMARTSTEP SERIES

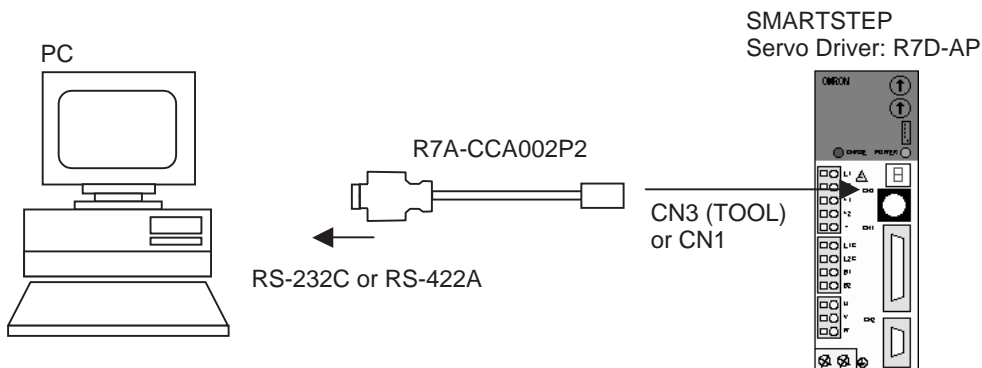

#### ● With W SERIES

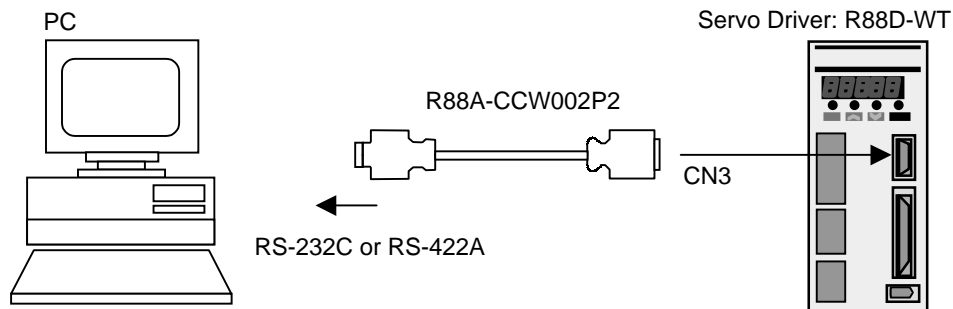



■ CONNECTION METHOD

● With SMARTSTEP SERIES

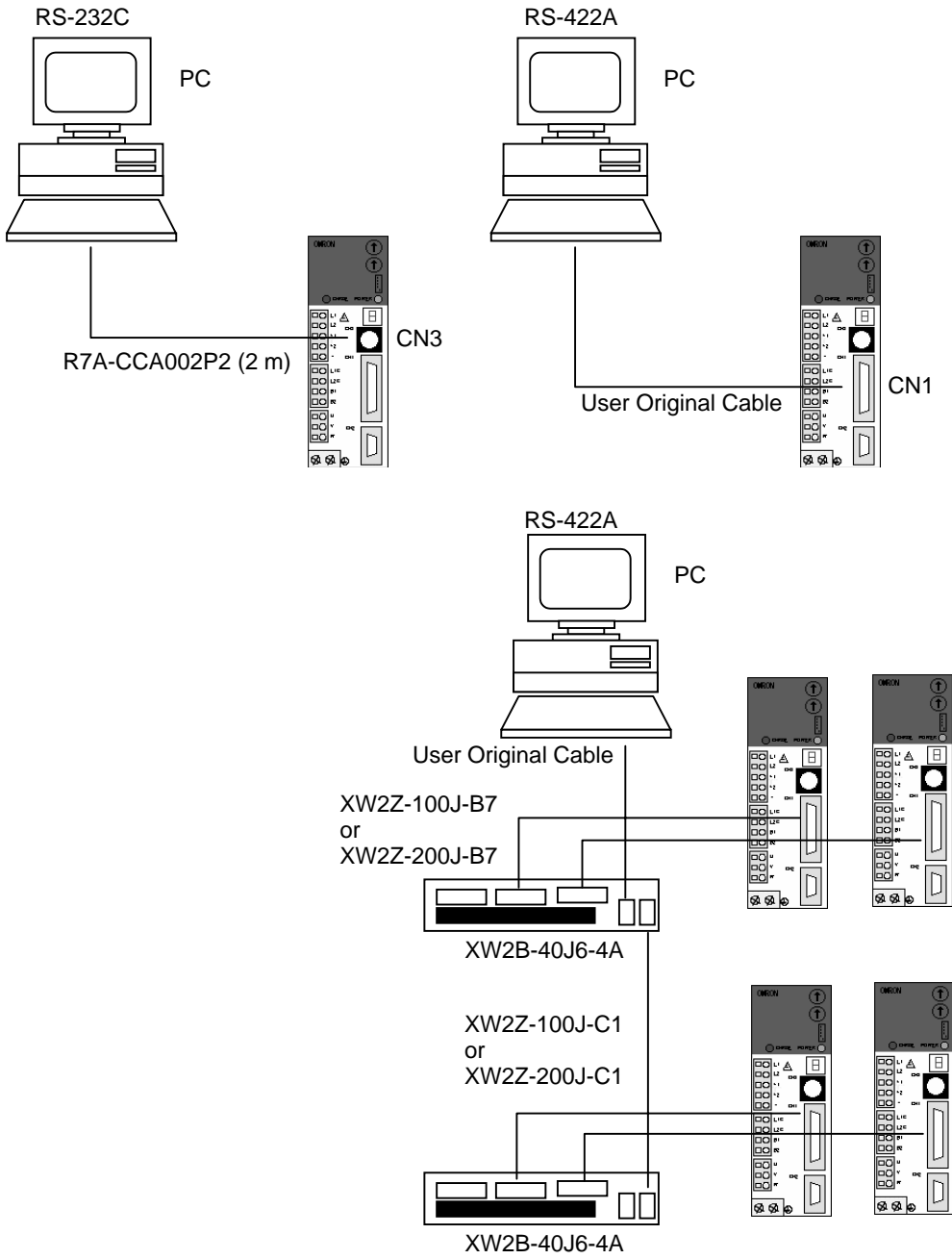

● Connection diagram for SMARTSTEP Servo Driver

RS-232C (Max.: 2 m)

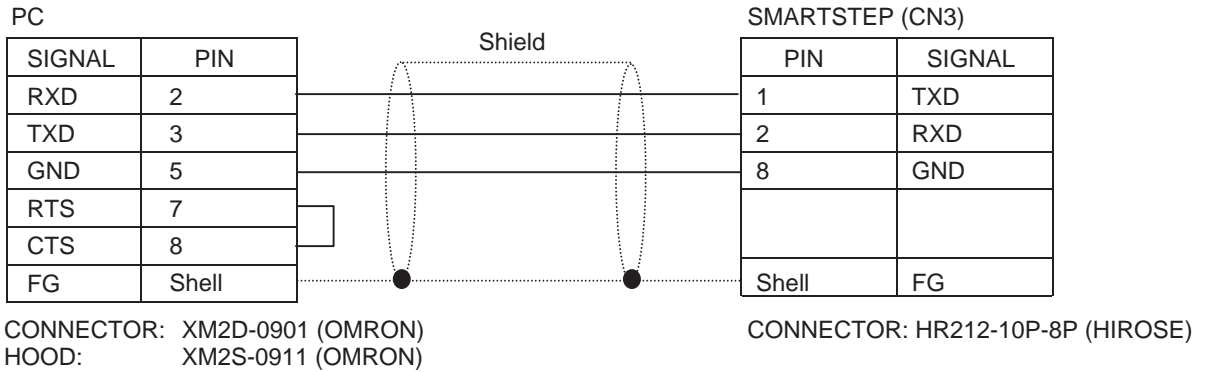

RS-422A (Max.: 30 m): Single

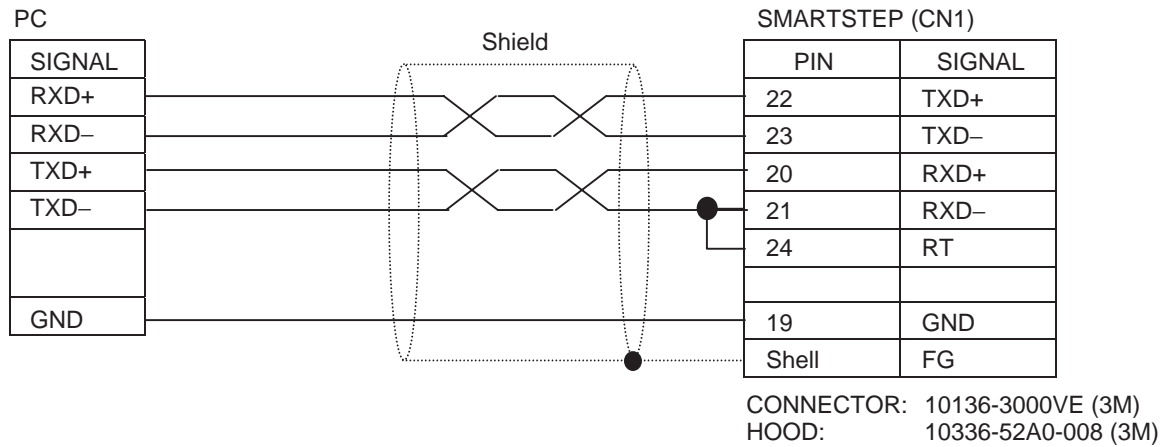

RS-422A (Max.: 30 m): Single/Multiple with Terminal Block

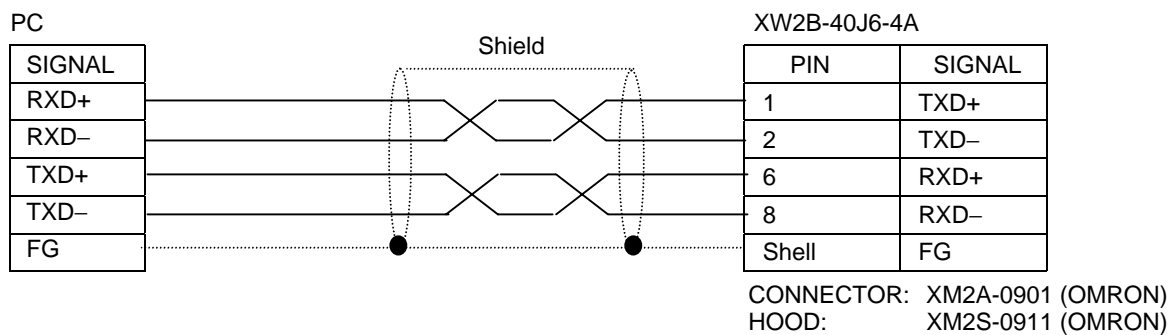

RS-422A (Max.: 30 m): Multiple without Terminal Block

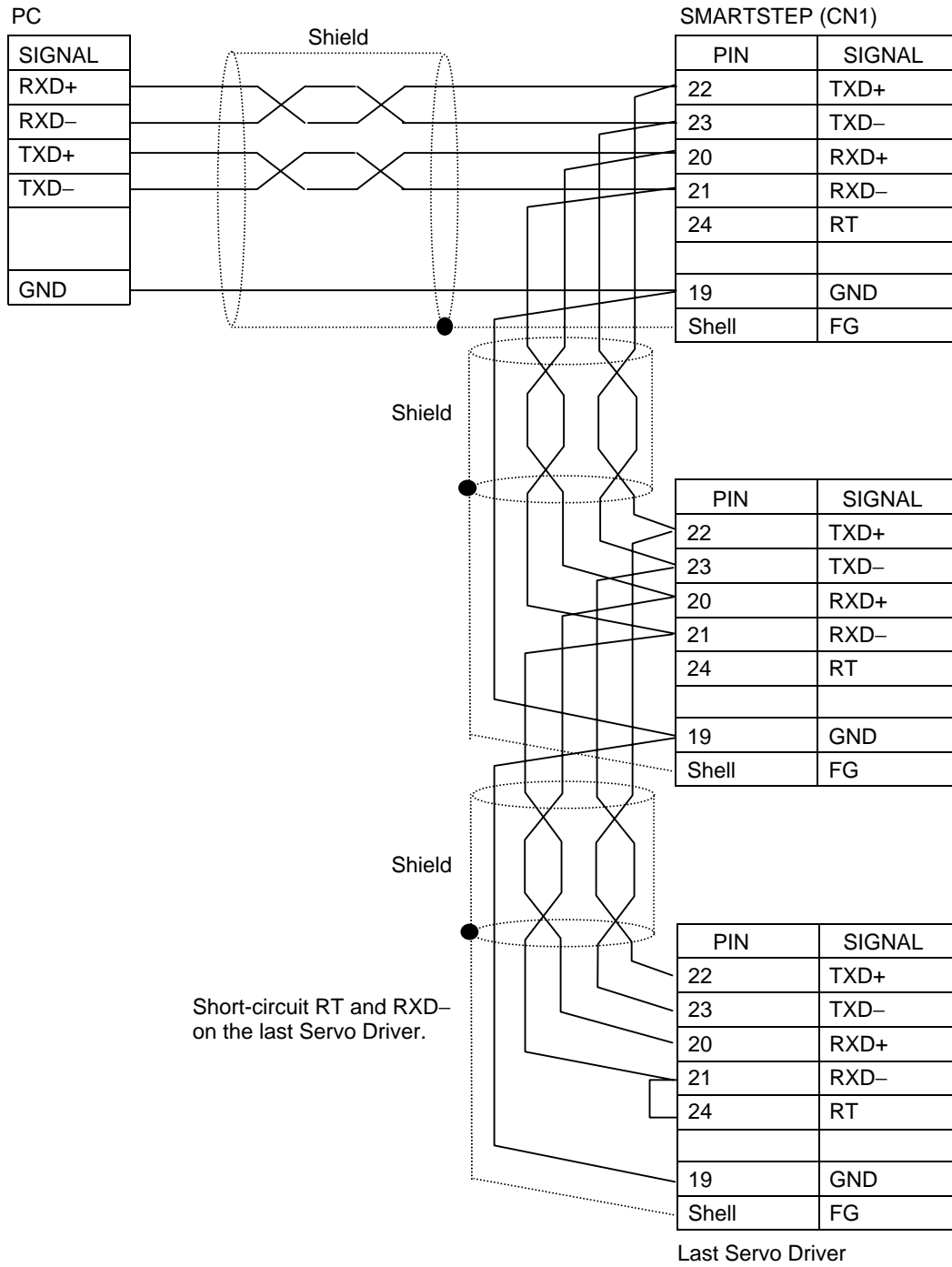

● With W SERIES

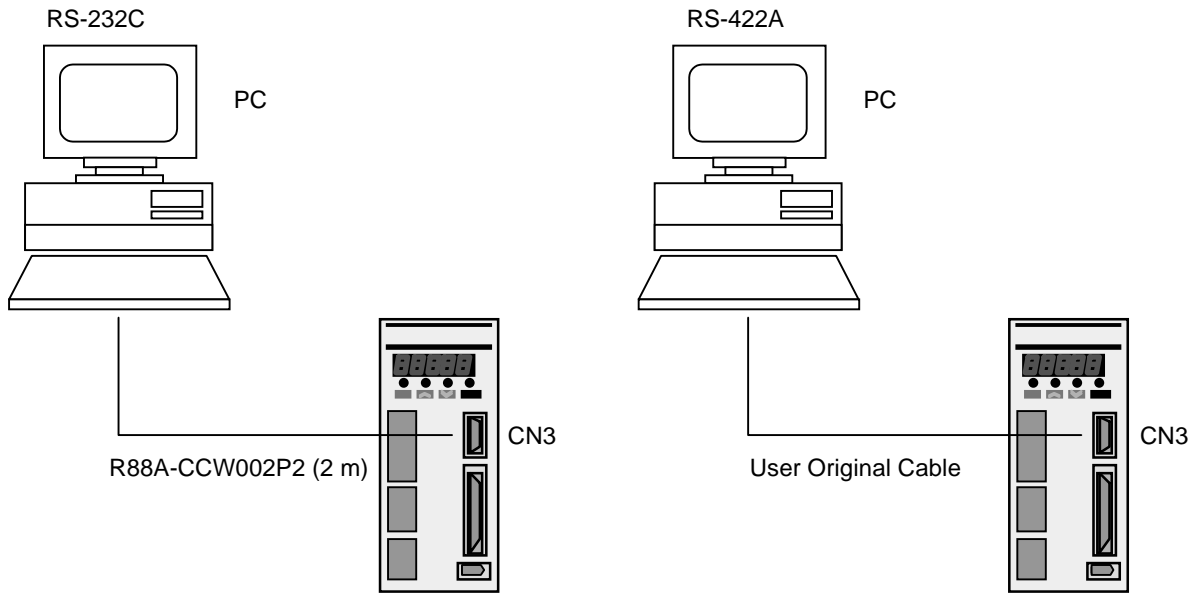

● Connection diagram for W SERIES Servo Driver

RS-232C (Max.: 2 m)

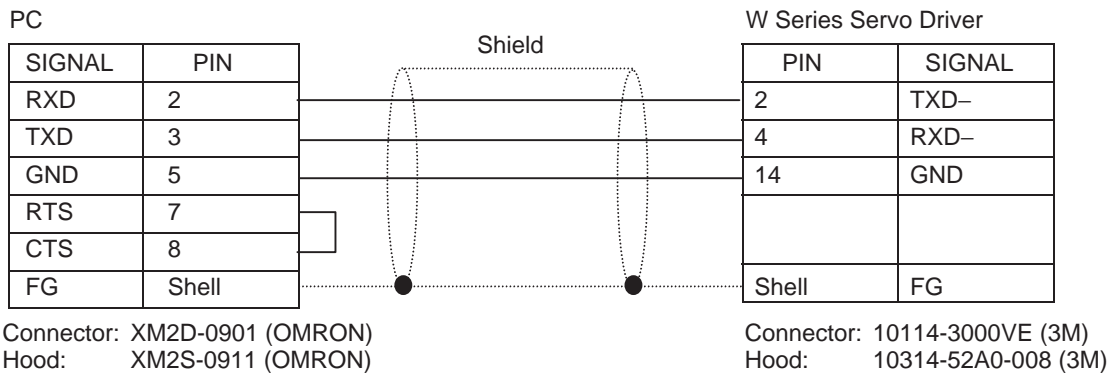

RS-422A (Max.: 30 m): Single

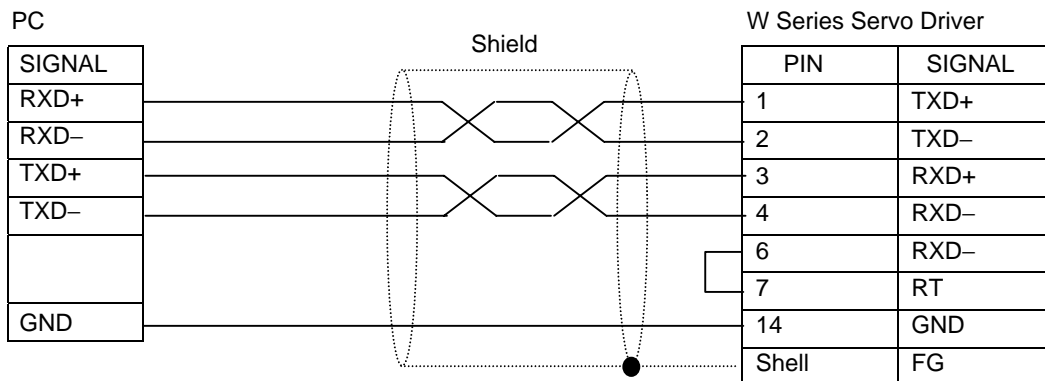

RS-422A (Max.: 30 m): Multiple

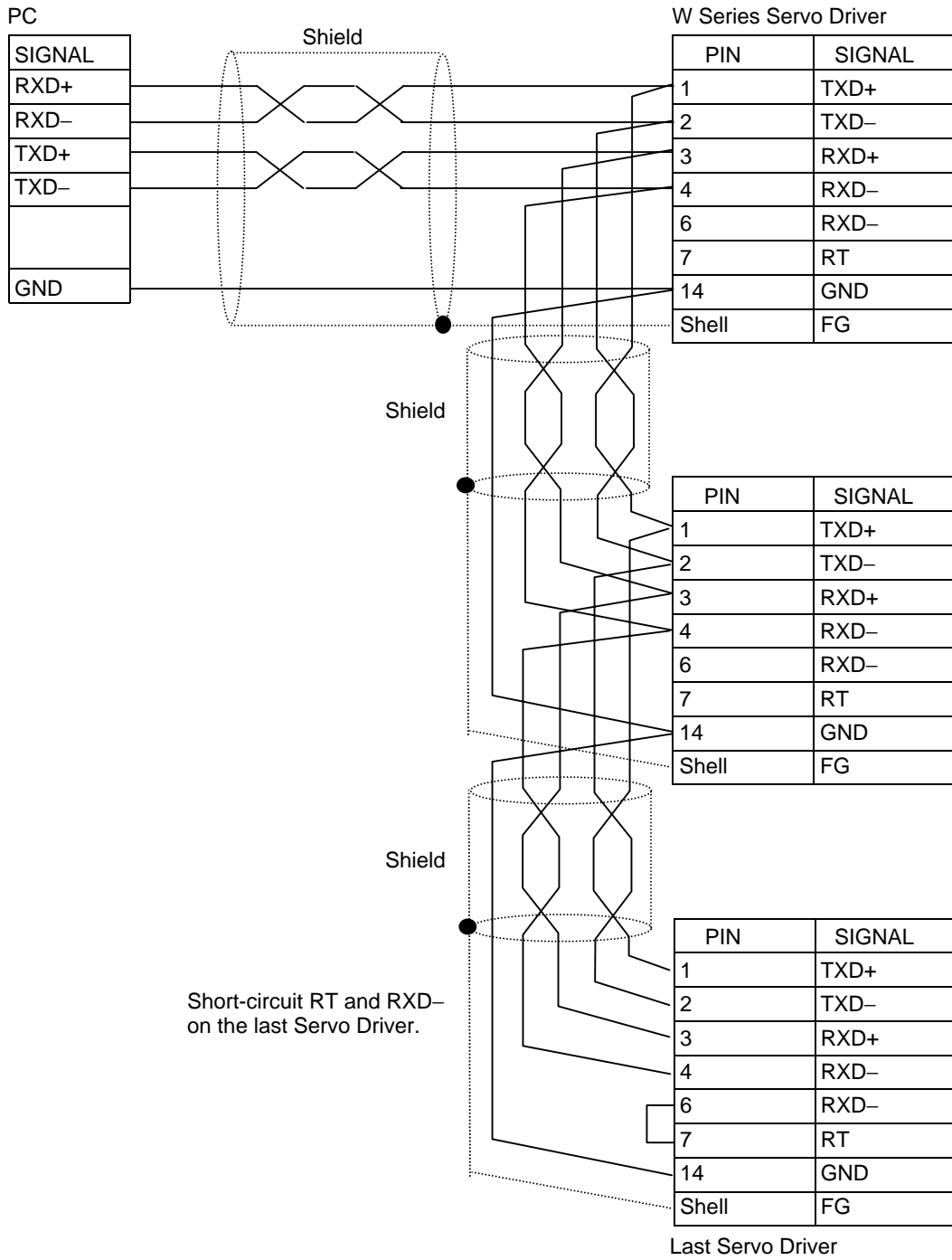



## **Chapter 3**

# **BASIC OPERATION**

3-1 START/QUIT

---

## 3-1 START/QUIT

---

### ■ STARTING

Either of the following operations starts WMON Win.

- Double-click WMON Win E Ver. 2.00 Icon in OMRON Folder on the desktop.
- Click **Start** in the taskbar and move the cursor **Program/OMRON/WMON Win Ver. 2.00**. Click **WMON Win Ver. 2.00** to start.

### ■ QUITTING

One of the following operations closes WMON Win Ver. 2.0.

- Click **Close** in the **Control Menu** on the title bar.

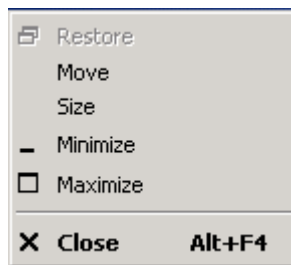

- Click **Exit** in the **File Menu**.
- Click the **Close** Button  in the title bar.

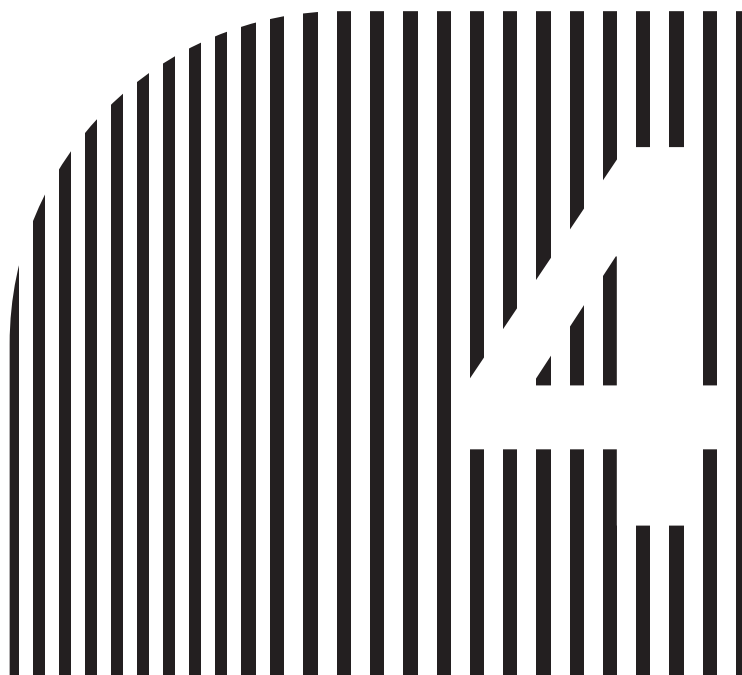

## Chapter 4

# OPERATION METHOD

- 4-1 COMMUNICATIONS SETTINGS
- 4-2 DRIVER CONNECTION AND DISCONNECTION
- 4-3 PARAMETER EDIT/SAVE/TRANSFER
- 4-4 MONITOR
- 4-5 ALARM
- 4-6 JOGGING/MOTOR ORIGIN SEARCH



## 4-1 COMMUNICATIONS SETTINGS

### ■ COMMUNICATIONS SETTINGS

Communications settings will proceed as follows:

1. Click **Connect** in the **File Menu**. The Connect Dialog Box will be displayed as shown below.

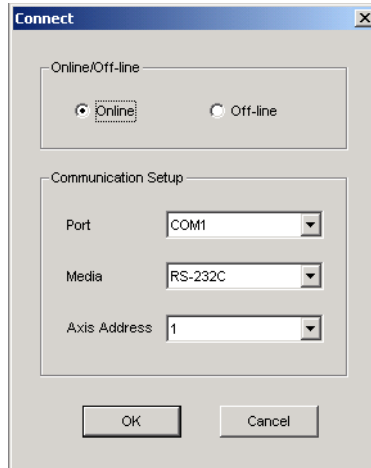

2. Select Online.

Select a port for communication with the Servo Driver in the Port Box.

Select a medium to be used for communications in the Media Box.

Set the same unit No. set on the connected Servo Driver in the Axis Address Box.

### ■ COMMUNICATIONS WITH MULTIPLE SERVO DRIVERS

When RS422A cable is used, WMON Win can establish communications with multiple Servo Drivers. To establish communications among multiple Servo Drivers, follow the procedures below.

1. Connect the personal computer to the Servo Driver with RS422A cable.
2. Click **Connect** in the **File Menu** to display Connect Dialog Box.
3. Select RS422 in the Media Box.
4. Set the last unit No. of the connected Servo Drivers.
5. Follow the procedures in 4-2 *DRIVER CONNECTION AND DISCONNECTION* to connect to the Servo Driver.

Connection to another Servo Driver cannot be made during the setting for a Servo driver. Once the operation of the connected Servo Driver is completed, click **Connect** in the **File Menu** to make connection to another Servo Driver, following the procedures in 4-2 *DRIVER CONNECTION AND DISCONNECTION*.

---

## 4-2 DRIVER CONNECTION AND DISCONNECTION

---

### ■ DRIVER CONNECTION

To connect to a Servo Driver, follow the procedures below.

1. After the procedures in 4-1 *COMMUNICATIONS SETTINGS*, the following dialog box will be displayed.

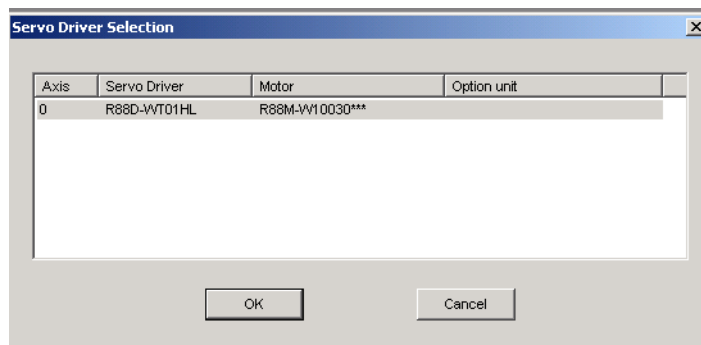

2. Select a Servo Driver and click the **OK** Button. The basic window will be displayed.

### ■ DRIVER DISCONNECTION

The following operation disconnects a Servo Driver.

1. Click **Disconnect** in the **File Menu**. The communications with the Servo Driver will be disconnected.

4-3 PARAMETER EDIT/SAVE/TRANSFER

■ EDIT PARAMETERS

Follow the procedures below to edit parameters.

1. Click **Parameters/Edit Parameters**. The following window will be displayed.

● Parameter edit window

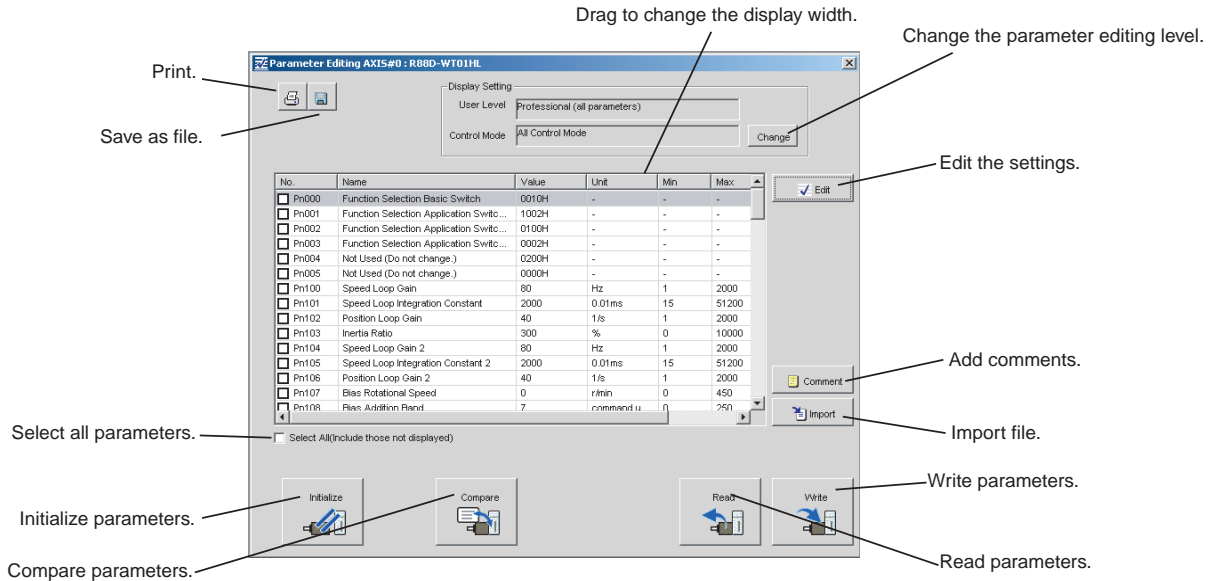

The contents of the window above are as follows:

Item	Content
No.	Indicates parameter Nos. By marking the box on the left, the marked parameters will be initialized, compared, read, or written. Additionally, parameters for which the setting values are changed will be marked.
Name	Indicates the names of parameters.
Value	Indicates the current setting values of parameters. Change the values in this column when editing the parameters. The color of the column will change when the parameter setting value read from a Servo Driver or a parameter file is changed.
Unit	Indicates the setting units for parameters.
Min	Indicates the minimum value that can be set for each parameter. Setting a smaller value than the minimum value will cause a setting error.
Max	Indicates the maximum value that can be set for each parameter. Setting a larger value than the maximum value will cause a setting error.
Default	Indicates the factory default value for each parameter. Clicking the <b>Initialize</b> Button will change the current setting values of the marked parameters to the default values.

Edit parameters through the following operations.

### ● Parameter setting method

Change setting values through either of the following operations.

- Click on the parameter to be edited and click the **Edit** Button.
- Double-click on the parameter to be edited.

The Edit Window will be displayed. Change the settings as needed and click the **OK** Button.

### ■ SAVE PARAMETERS

Save parameters through the following operations.

1. Click the **File Save** Icon at the upper left corner. The Save As Window will be displayed.
2. Enter a file name and click the **Save** Button.

### ■ TRANSFER PARAMETERS

#### ● Sending all parameters being edited to a Servo Driver

1. Click the **Select All** Check Box.
2. Click the **Write** Button and all the parameters will be sent to a Servo Driver.

#### ● Sending selected parameters to a Servo Driver

1. Click the check boxes in the No. column for the parameters to be sent.
2. Click the **Write** Button and the selected parameters will be sent to a Servo Driver.

#### ● Receiving all parameters from a Servo Driver

1. Click the **Select All** Check Box.
2. Click the **Read** Button and all the parameters will be received from a Servo Driver.

#### ● Receiving selected parameters from a Servo Driver

1. Click the check boxes in the No. column for the parameters to be received.
2. Click the **Read** Button and the selected parameters will be received from a Servo Driver.

### ■ COMPARE PARAMETERS

Parameters being edited are compared with the ones in a Servo Driver.

1. Click the **Compare** Button. The Compare Confirmation Dialog Box will be displayed.
2. Click the **OK** Button. The comparison will be executed and the result will be displayed.
3. The parameters with differences will be listed up. At this point, the comparison result can be saved. To save the result, click the **Save** Icon in the Comparison Results Window. After entering a file name, click the **Save** Button.

■ INITIALIZE PARAMETERS

Parameters in a Servo Driver are initialized.

1. Click the **Initialize** Button. The Verification Dialog Box will be displayed.
2. Click the **OK** Button and the initialization will be executed.

■ READ PARAMETERS

Saved parameter file is read.

1. Click the **Import** Button. The Open Dialog Box will be displayed.
2. Enter a file name to be read and click the **OK** Button. The file will be imported.

■ ENTER COMMENTS

Comments can be entered to record setting history, etc.

By saving parameters, comments are also saved.

1. Click the **Comment** Button. The Comment Window will be displayed.
2. Enter comments and click the **OK** Button.

■ EDIT PARAMETERS ONLINE

Parameters can be edited online. For gain adjustment, etc., this function comes handy when parameters are to be changed real-time.

1. Click **Parameters/Edit Online Parameters**.

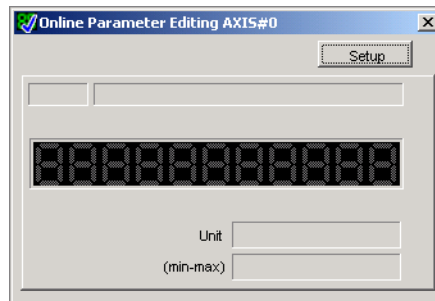

2. Click the **Setup** Button. The Set Parameters Dialog Box will be displayed. Click the **Set** Button to display the parameter list. Select a parameter and click the **OK** Button.

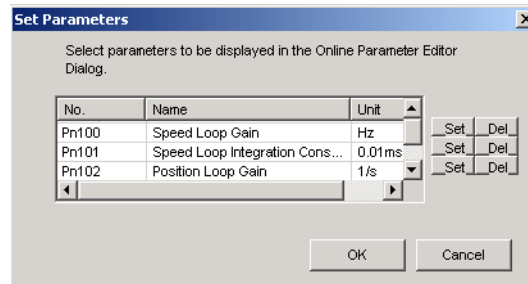

3. Click the **OK** Button to bring back the Set Parameters Dialog Box with the selected parameter on it. Click the **OK** Button and the following window will be displayed.

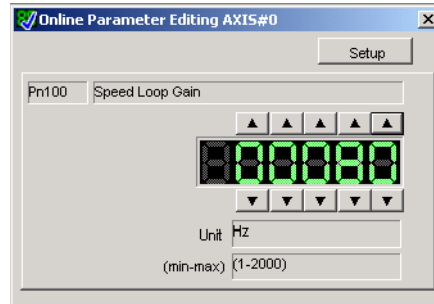

4. Change the parameter using the digital switches in the window.

● **Creating a new parameter file offline**

1. Click **Parameters/Edit Parameters**. The following dialog box will be displayed.

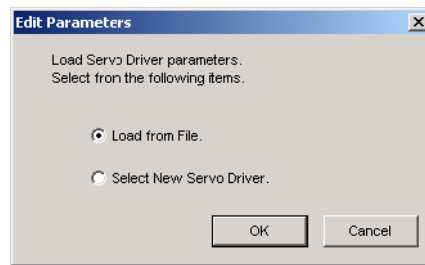

2. Select "Load from File" to edit a saved file. Select "Select New Servo Driver" to create a new file. After the selection is made, click the **OK** Button.

3. When "Load from File" is selected, the Open Dialog Box will be displayed. Select a file name and click the **OK** Button to display the Parameter Edit Window.

4. When "Select New Servo Driver" is selected, the Servo Driver Selection Dialog Box will be displayed.

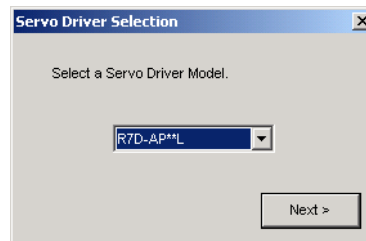

Select a Servo Driver whose parameters are to be edited and click the **Next** Button. The following dialog box will be displayed.

Ver/Capacity/Special Spec.

Servo Driver Model

R7D-AP\*\*L

Ver

Input the 5 digit version number on front of Servo Driver.

00000  Unknown

Capacity

Select Servo Driver Capacity.

A3 (30W)

Special Spec.

Select Special Spec. number.

Standard

< Back Done

5. Enter the software version of the Servo Driver, select a Servo Driver Capacity, and click the **Done** Button. The Parameter Editing Window will be displayed. Follow the procedures described in *EDIT PARAMETERS* of 4-3 *PARAMETER EDIT/SAVE/TRANSFER*.

## 4-4 MONITOR

Operation and I/O status of the Servo Driver and Servomotor can be monitored. Follow the procedures below.

1. Connect to a Servo Driver following the procedures described in 4-2 DRIVER CONNECTION AND DISCONNECTION.
2. Click **Monitor/Monitor** and select an item to be monitored.

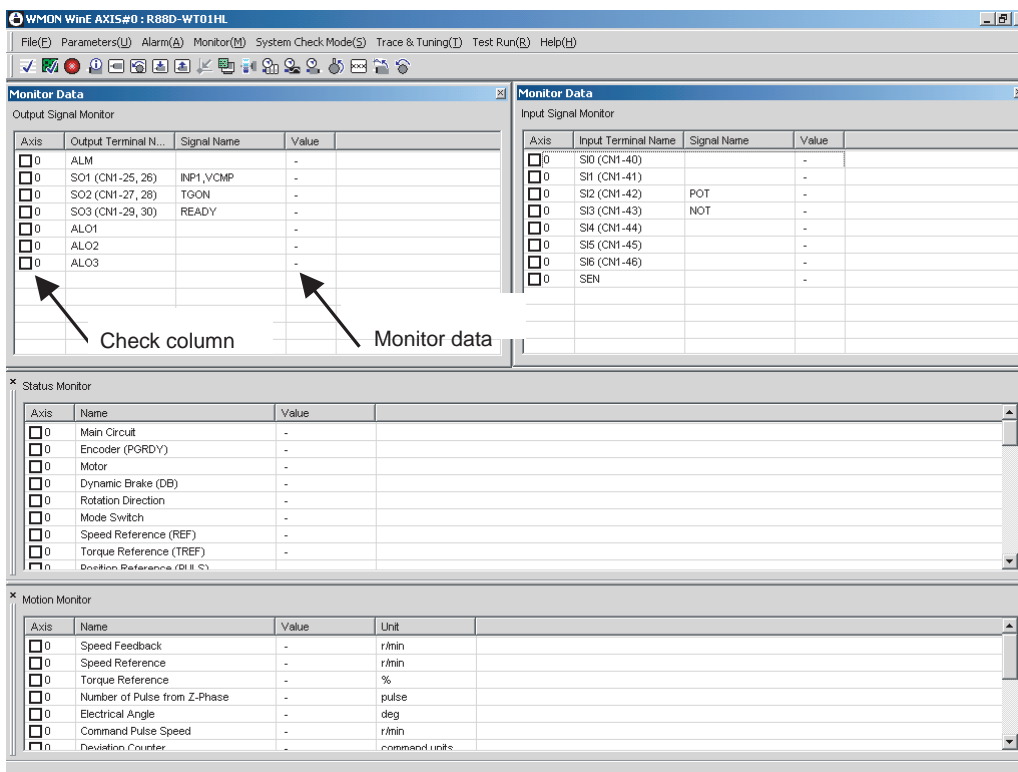

3. Click on the check box for each monitored item. The monitor data will be displayed in the Value Column.



4-5 ALARM

Alarm status of the Servo Driver and Servomotor can be monitored. Additionally, alarms can be reset, alarm history can be monitored, and alarm history can be cleared. See the Alarm Display Window below.

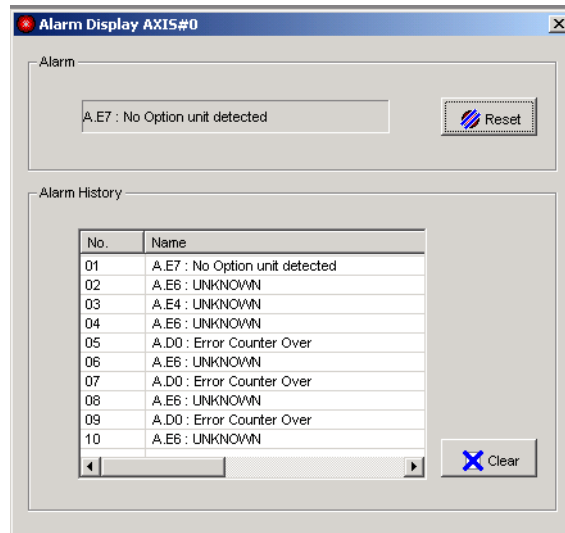

## 4-6 JOGGING/MOTOR ORIGIN SEARCH

Through WMON Win operation, Jogging and Motor Origin Search can be executed.

During Jogging or Motor Origin Search, input of the control input signal (CN1) is disabled. Perform either without any load on the motor.

**Caution** Check that people or obstructions are not in the vicinity of the motor or machinery when using the Jogging operation. Also, do not connect or disconnect cables, interrupt the personal computer's monitoring software operation, or turn OFF the personal computer during operation. Otherwise, the equipment may be damaged.

Follow the procedures below to perform Jogging.

1. Turn OFF the RUN Command Input (RUN) of the Control Inputs (CN1) on the Servo Driver.
2. Connect to the Servo Driver following the procedures described in *4-2 DRIVER CONNECTION AND DISCONNECTION*.
3. Click **Test Run/Jog**. Jog Operation Warning Dialog Box will be displayed. Read and understand the content and click the **OK** Button. The following window will be displayed.

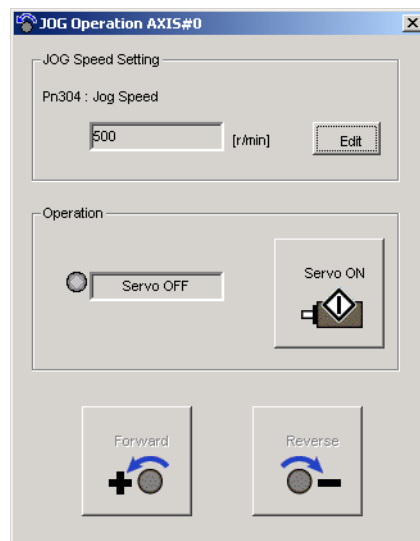

4. Click the **Edit** Button and set the Jog Speed. (The value set here will be reflected in the parameter (Jog Speed) on the Servo Driver.)
5. Clicking the **Servo ON** Button will start power distribution to the Servomotor.
6. Rotate the Servomotor using the **Forward** and **Reverse** Buttons.
7. Click **Servo OFF** to finish Jog Operation.

To perform Motor Origin Search, click **System Check Mode/Search Motor Origin**. Follow the procedure through 5 to 7 for Jog Operation.



# Revision History

A manual revision code appears as a suffix to the catalog number on the front cover of the manual.

Cat. No. I541-E1-01

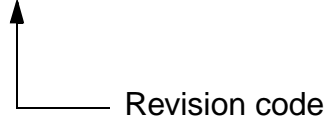

The following table outlines the changes made to the manual during each revision. Page numbers refer to the previous version.

Revision code	Date	Revised content
01	December 2003	Original production

---

*Revision History*

---

# OMRON

**OMRON Corporation**

FA Systems Division H.Q.

66 Matsumoto

Mishima-city, Shizuoka 411-8511

Japan

Tel: (81)55-977-9181/Fax: (81)55-977-9045

***Regional Headquarters***

**OMRON EUROPE B.V.**

Wegalaan 67-69, NL-2132 JD Hoofddorp

The Netherlands

Tel:(31)2356-81-300/Fax:(31)2356-81-388

**OMRON ELECTRONICS LLC**

1 East Commerce Drive, Schaumburg, IL 60173 U.S.A.

Tel:(1)847-843-7900/Fax:(1)847-843-8568

**OMRON ASIA PACIFIC PTE. LTD.**

83 Clemenceau Avenue, #11-01, UE Square,

Singapore 239920

Tel:(65)6835-3011/Fax:(65)6835-2711

**Authorized Distributor:**