

USER'S MANUAL

ZEN High



Manufactured by:

**Planika Sp. z o.o.
ul. Bydgoska 38
86-061 Brzoza
Poland**

IT IS OBLIGATORY TO READ AND KEEP THIS INSTRUCTION MANUAL.

TABLE OF CONTENTS

I. General information.....	3
II. Fuel.....	3
III. Safety.....	3
IV. Operation	
Operating elements.....	4
Initial start-up of the device.....	5
Flame size regulation.....	6
Device extinguishing.....	6
Subsequent start up.....	6
Information and warning alert.....	6
V. Cleaning and maintenance.....	8
VI. Disposal and recycling.....	8

I. General information

The ZEN HIGH is a decorative appliance with real flames. Due to the innovative technology applied, the ZEN is simple and safe to use.

II. Fuel

In order for the Zen High to function correctly use the recommended FANOLA® liquid or other available on the market and fulfilling the criteria of being a 86-96% denatured ethanol in accordance with the European Union guidelines (Directive No. 162/2013).

Using other liquids is prohibited as it may lead to incorrect functioning of the device, damage of the device and/or may cause fire or and/or health risk. The manufacturer takes no responsibility for damage caused by using prohibited liquids such as absolute ethanol.

III. Safety



The Zen High produces a real open fire, so, in order to use the device properly and safely and in order to keep the warranty, the following safety rules should be observed.

- Do not expose the device to weather conditions. The product is for internal use only.
- Please read the device installation manual to avoid placing the device in rooms with a capacity of less than required.
- While working, the device emits heat, water vapour and carbon dioxide, therefore it is necessary to provide proper ventilation of the interior, so that the total air exchange is 1/h.
- During the device's starting sequence the characteristic smell of the liquid used in the device or the recommended FANOLA® liquid.
- Do not install the device in areas of large drafts of air, near fans, vents, etc.
- Do not place in areas where there might be a potentially explosive atmosphere of paint vapours, industrial dusts, etc.
- Do not use the device at the ambient temperature below 10°C (50° Fahrenheit) or higher than 30°C (86° Fahrenheit).
- Install the device only on a flat, horizontal surface. Setting on an inclined surface can cause incorrect operation, permanent damage to the device or cause fire.
- No flammable items should be placed in direct contact and within a radius of 1 m / 3.28 ft around the device. Do not place near curtains, net curtains, etc.
- It is obligatory to have a carbon-dioxide or dry chemical extinguisher placed nearby the device.
- The enabled device must not be moved. Wait for complete fuel burn-out, disconnect the power supply and cool down the elements before moving the device.
- The device should not be left without adult supervision.
- Prevent handling of the device by persons not trained.
- Do not attempt to make changes or repairs to the construction of the device on your own. Repairs can be made only by a person trained to service the device.
- Do not pour FANOLA liquid to a furnace, as it may cause damage of the device and cause fire. Pouring FANOLA liquid to a burning furnace may cause a sudden ignition and can cause fire, burns and a risk to life.
- Do not heat the FANOLA liquid before starting-up the device.
- Do not start up the device if the FANOLA liquid spilled out from the container.
- Do not cover the working device as it may cause fire.
- Keep the device and fuel away from children, pets and unauthorized persons.
- FANOLA liquid is not suitable for consumption. Avoid contact with skin and eyes.
- Do not operate by the filler when the device is running.
- Do not tamper with the elements inside the furnace body at the risk of burns, damage to the device or fire.
- Some elements of the device heat up to high temperatures. Do not touch the area of the furnace of the device as it may cause burns.

- Do not place any decorative elements on the burner's surface.
- Warning! The glowing coil temperature heats up to 1300 °C. Touching the device while it is turned on may cause burns.
- Warning! The furnace heats up to high temperatures during operation!
- **WARNING! The first run can be made only after proper installation of the device and reading the manual instructions!**
- **WARNING! Prior to moving the appliance burn the fuel out and move the appliance slowly, in the horizontal position, avoiding shaking. There is always some fuel left inside the device and if spilled the sensors might get wet. If that happens the appliance will not work until the liquid evaporates.**

IV. Operation

This manual contains all the information necessary for the proper operation of the Zen High. **It is obligatory to read and keep this instruction manual.** Operation of the device is permitted only after the device is properly installed according to the instructions and the manual.

A. Operating elements

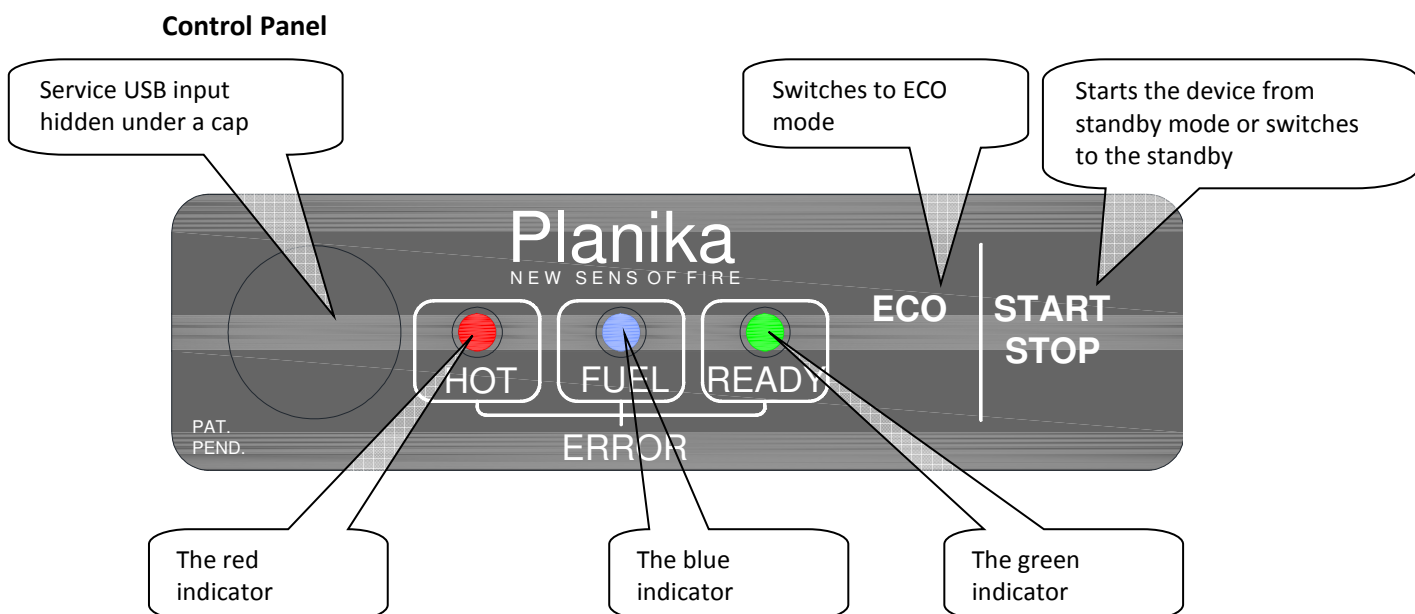
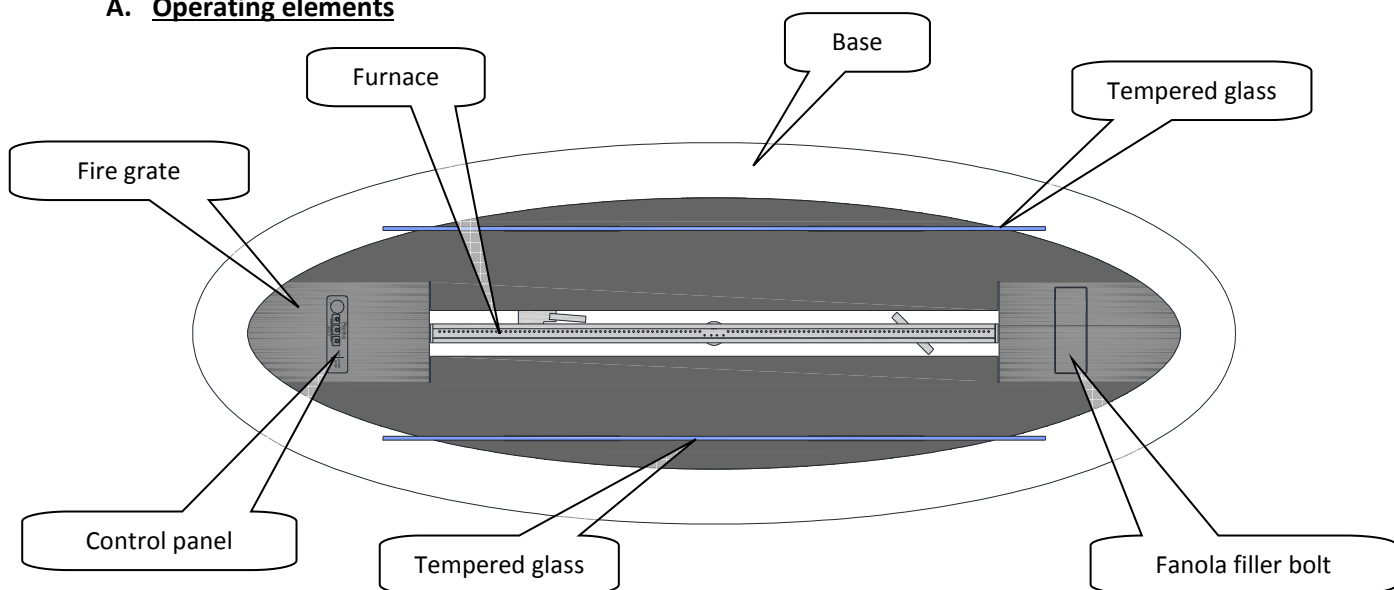

B. Initial start-up of the device

1. On the control panel the blue light flashes  it indicates the lack of fuel in the tank. Please refuel.
2. Refueling.

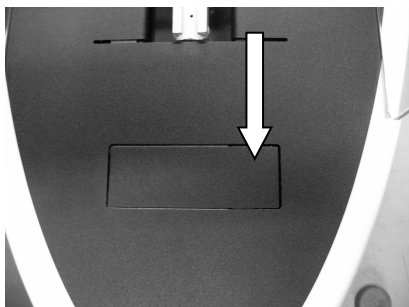

2.1. Open the Fanola filler bolt.



2.2. Insert the funnel.





2.3 Pour the fuel into the funnel **following these precautions:**

- During pouring be careful not to spill fuel out of the filler. If the fuel is spilled error message is displayed    go to step F, and follow the guidance provided in the table. **If the spillage is excessive the source of power needs to be disconnected.**
- If 5L containers are used to fill up, twist on the cap with the tap onto the container and pour using the funnel. To fill up use only accessories provided by the manufacturer.



2.4 Pour the fuel to the point where the blue indicator blinks  and the intermittent beep will sound. Stop pouring! Remove the funnel.

2.5. Close the Fanola filler bolt. The green indicator  will flash on the control panel.

3. Device extinguishing. The green indicator flashes on the control panel .

3.1. Press the **START / STOP** button on the control panel and hold for 2 seconds - You will hear a single beep.

3.2. The green indicator will blink



to indicate start-up of the device, it takes a few moments for the appliance to ignite the flame.

3.3. While the appliance is in work mode, the green indicator goes off and the flame starts to appear. The device works automatically until they run out of fuel or disable the device by the user.

C. Flame size regulation

The Zen High can operate in two modes: Normal and ECO. The device always starts with a standard flame size. The device has the adjustable flame size during operation.

In order to reduce the height of the flame, press the ECO button. You will hear two beeps and the ECO button will be highlighted. The unit is now operating in ECO mode.

To return to the normal height of the flame, press the ECO button, you will hear one beep and the ECO button backlight turns off. The device is now in normal mode.

ATTENTION! It might take a few moments for the flame to adjust.

ATTENTION! The device switches to ECO mode by itself when there is a danger of over-temperature of the device.

D. Device extinguishing

Press the **START/STOP** button on the control panel. You will hear two beeps and the red indicator will start to blink



The flashing red indicator means that the device is too hot to be restarted. When the device cools the message will disappear, and depending on the amount of the fuel in the tank, either the green indicator will flash and indicate the readiness for operation or the blue indicator will indicate the lack of the fuel.

E. Subsequent start up

If the blue indicator is flashing on the control panel, start from the point B.2.

If the green READY indicator is flashing on the control panel, you can:

- start from the point B.3.
- open the fuel filler bolt - the green READY indicator will go off. If:
 - the blue indicator blinks and a beep sounds intermittently - the tank is full and it is not allowed to pour any more fuel! Close the fuel filler bolt and proceed in accordance with section B.3.
 - the blue indicators flashes - you can refuel (see section B.2) and turn on the device (see section B.3) or close the fuel filler bolt and activate the device by following the point B.3.

F. Information and warning alert

In order to increase safety, the Zen High is equipped with an electronic system to keep the operation safe. In the case of a dangerous situation, the device immediately triggers alarms.

CAPTION:



The indicator is off













The indicator flashes



The indicator is blinking

Information and warning alerts

Lp.	Control Panel Indicators	SOUND SIGNALS		event	procedure
		constant	intermittent		
1				If the fire is not visible - NO POWER.	Make sure the device is properly connected to the power supply.
				If you see a fire - the device is in operation.	Do not leave the device unattended by an adult.
2				The device is ready for operation.	You can run the device in accordance with section B.3
3				No fuel in the tank	Fill the fuel in accordance with B.2 paragraph
4				Initial start-up of the device	Wait for the appearance of fire, the light goes off.
5				The device is protected against too rapid restart when the fireplace is cooling down or the allowable temperature has been exceeded – the fireplace will turn off	Allow the device to cool down. After cooling the device, the red indicator will turn off and the green indicator will start to flash.
6				The device automatically turns off due to lack of fuel in the tank.	Allow the device to cool down. After cooling the device, the red indicator will turn off
7			×	The fuel tank is full.	It is not allowed to pour any more fuel! Close the Fanola filler bolt. The blue indicator will turn off, the green one will start to flash.
8		×		There was a fuel spill or	Immediately stop pouring the fuel. Remove the funnel, dry a visible moisture. Press the START / STOP button to turn off the sound. If the spillage is excessive the source of power needs to be disconnected. With the use of the manual pump, supplied by the manufacturer, pump out at least 1 liter of fuel from the fuel filler. Wait at least 1 hour to evaporate the remaining moisture and then close the fuel filler bolt. Hold the ECO button for about 5 seconds. If the alarm message reappears, wait a little bit longer until the rest of the moisture evaporates. If the message reappears, contact your service provider.
				the acceptable device operation temperature has been exceeded.	If the alarm message appears during the start of the device, press the START / STOP button to turn off the sound and hold the ECO button for about 5 seconds. If the message reappears, contact your service provider.
9		×		Operation error	Press the START / STOP button to turn off the sound and hold the ECO button for about 5 seconds. If the message reappears, contact your service provider.
10		×		The device temperature below 10°C or critical operation error	Press the START / STOP button to turn off the sound. Provide higher ambient temperature. Wait until the device obtains the indoor temperature. Hold down the ECO button for about 5 seconds. If the message reappears, contact your service provider.

11		×		Filler bolt protection error.	Shut the filler bolt. Press the START / STOP button to turn off the sound and hold the ECO button for about 5 seconds. If the message reappears, contact your service provider.
----	---	---	--	-------------------------------	---

V. Cleaning and maintenance

Switch off the device before cleaning. Wait until the temperature of the device gets close to the ambient temperature. To maintain appropriate technical condition of the device, please observe the following rules:



- Clean the furnace with a soft cloth and water to avoid causing cracks and scratches

When purchasing and dozing cleaners, be sure to protect the environment and comply with the recommendations of manufacturers.

It is forbidden to clean the inside of the device by unauthorized persons.

The manufacturer does not foresee a situation where it will be necessary to clean elements not normally available.

The manufacturer is not liable for damage resulting from:

- improper operation (non-manual)
- self-dismantling
- attempts to modify
- using other liquids than those recommended in point II. Fuel.

VI. Disposal and recycling

The product is equipped with parts made of aluminium, steel, plastics and electronics. If you need to dispose of the device, follow the terms of disposal and recycling in force in your country.

Moreover, dispose of the empty Fanola containers should be dumped to plastic waste baskets.

Most of the materials used in Planika appliances can be recycled.

FANOLA® fuel recommended for this product has received following certification:



If you have any technical problems or other questions that need clarification, contact your dealer.