

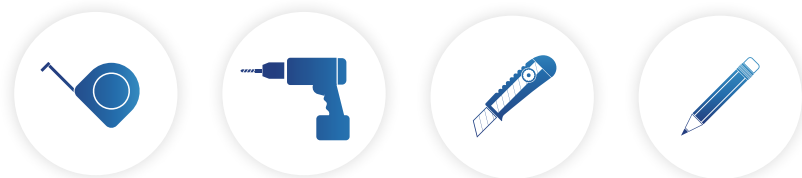

What you'll need

Necessary tools:

(screws included by the manufacturer)



You'll need these accessories to assemble your waterbed



Silvano Split



Scan the QR-code to watch the assembly video.



<https://www.youtube.com/user/silvanowaterbeds>

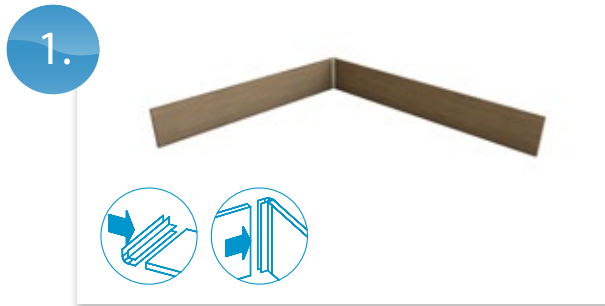

The shorter skirting boards run along the width, while the longer boards run along the length.

Skirting board sizes: more info on p. 8

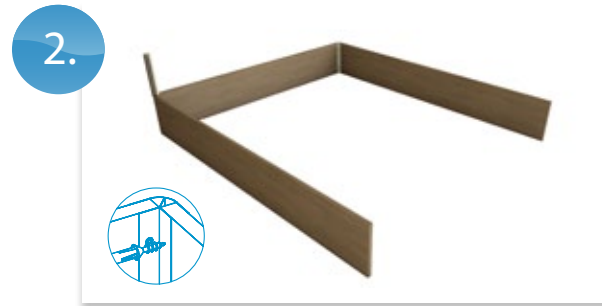

Connect the four skirting boards using the four supplied PVC corner connectors.

(Insert four short screws into every PVC corner connector.)

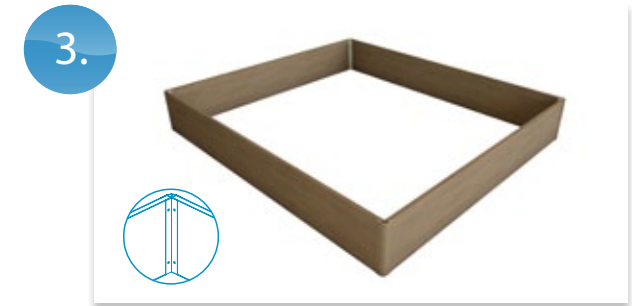

Choose precisely where you would like your waterbed. Once it is filled with water, it cannot be moved.



If you have a base with storage drawers, check the supplied assembly instructions..

<https://www.youtube.com/user/silvanowaterbeds>

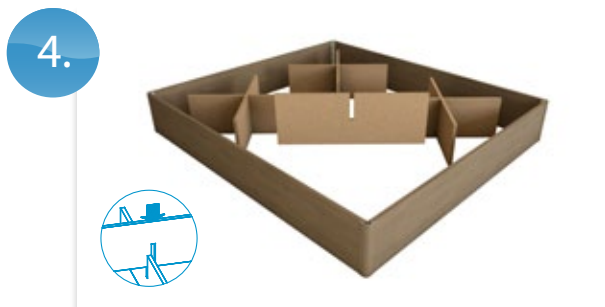

Sliding the notches in the wooden panels into one another forms a cross.

The 4 crosses serve as weight distributors and are placed inside the skirting frame.

See p. 7 for placement of weight distributors according to bed size.



Make sure that the weight distributors are evenly spaced inside the skirting frame.



Place the 2 split sections onto the base and make sure that they are parallel with the base.

Use 2 long screws to secure each split section to the skirting boards (at head and foot)



7. Place the base cover onto both split sections. Make sure that the zip is at the head of the bed.

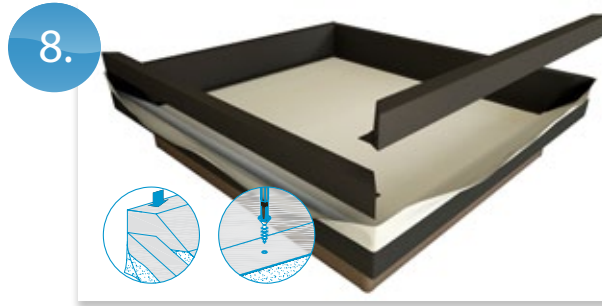

8. The shorter foam borders run along the width, while the longer foam borders run along the length.

Place the 4 foam borders inside the base cover on the foam border underlays, making sure that the corners match precisely. Then use screws to secure each foam border to the baseplates with the strips attached to the foam borders.

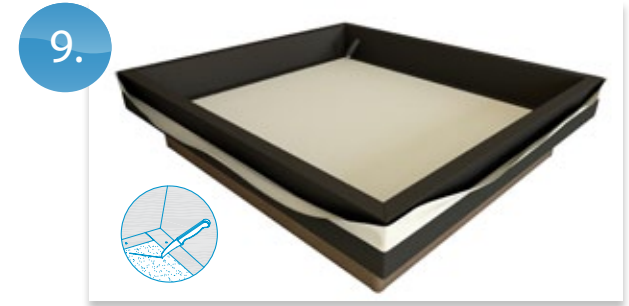

9. Use a sharp knife to make a small 0'4" (10 cm) incision in the base cover in the left corner of the head side. If you have a Duo-system, do the same in the right corner.



10. Now position the heating element. Make sure that the heating element is placed at least 0'6" (15 cm) from the border. It must rest fully on a single split section and never overlap the two split sections. Run the lead out of the waterbed through the incision in the corner. The thermostat should now be outside the waterbed. If preferred, it can be mounted on one of the skirting boards afterwards.

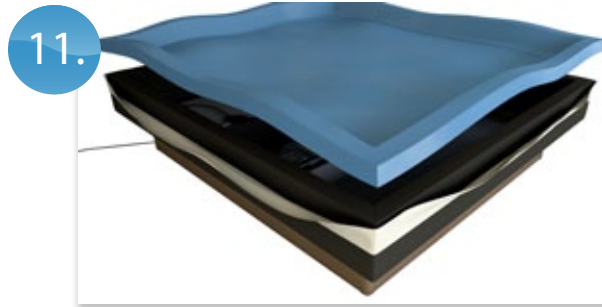

11. Now place the safety lining inside the four softside foam borders and pull its edges over the foam borders.



12. Make sure that the corners of the lining snugly fit the corners of the foam borders and that the lining sits smoothly on the heating element.

Silvano Split



13. The thermo divider (if ordered extra) can only be used with a Duo-system. Place the divider underneath and between the mattresses with the wider side towards the bottom.

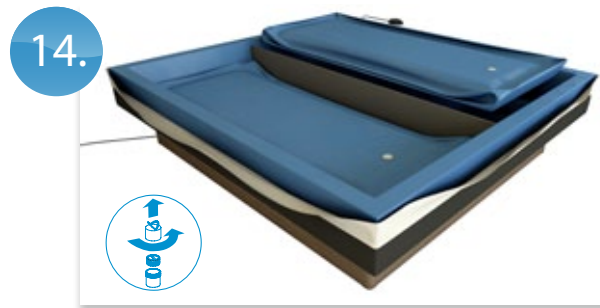

14. Now place the water mattress inside the safety lining (with its fill nozzle at the foot).
Open the nozzle(s) so that air enters the water mattress. Do this by pulling up the nozzle(s) with a twisting motion, unscrewing the cap(s) and removing the stopper(s).



15. Smoothen the water mattress thoroughly, removing all folds. Make sure that the 4 corners snugly fit the corners of the foam borders.



16. Fill the water mattress with lukewarm water at a temperature of app. 27 °C.

Before using the hose, rinse it with hot water to eliminate bacteria that may be present.



17. Close the tap after 10 minutes and check once again that the 4 corners of the water mattress snugly fit the corners of the foam borders. Turn the tap back on.

The water mattress is full once the water level is 0'0" (0,5 cm) below the edge of the bed.



18. Attach the Air Extractor to the nozzle using a twisting motion.

Now bleed the air from the waterbed by pushing the air from the head of the bed towards the nozzle. Move the handle of the Air Extractor up and down to pump out the air. Repeat until all the air is removed from your water mattress.

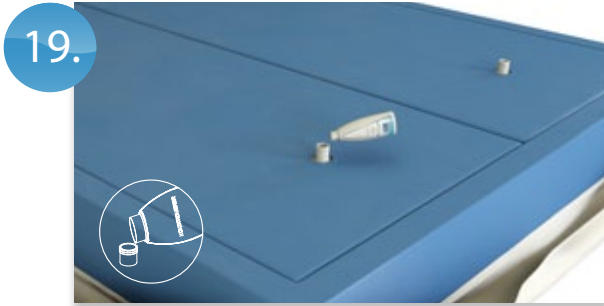

Now add 1x 150 ml bottle of Silvano conditioner to the water.

If you have a Duo-system, divide 1x 150 ml bottle of Silvano conditioner between both water mattresses.

Place the stopper back inside the nozzle, replace the cap and push the nozzle back into the mattress.



Set the thermostat to the desired temperature. We recommend a temperature of 28 °C. Now zip the top mattress cover to the undercover.

Your waterbed is ready for use. Silvano Waterbedden wishes you pleasant dreams!



Stretch the topline over the foam borders. Make sure that the 4 corners snugly fit the corners of the foam borders.

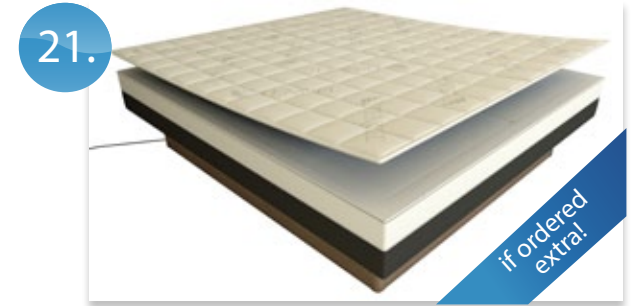

Make sure that the elastic trim goes underneath the foam borders (just like a fitted sheet).

Diagrams

Placement of weight distributors

Bed sizes

- 2'11" x 6'7" (90 x 200 cm)
- 2'11" x 6'11" (90 x 210 cm)
- 2'11" x 7'3" (90 x 220 cm)
- Single 3' x 6'6" (91 x 198 cm)
- 3'3" x 6'7" (100 x 200 cm)
- 3'3" x 6'11" (100 x 210 cm)
- 3'3" x 7'3" (100 x 220 cm)



Bed sizes

- 3'11" x 6'7" (120 x 200 cm)
- Super Single 4' x 6'6" (122 x 198 cm)
- Double 4'6" x 6'6" (137 x 198 cm)
- 4'7" x 6'7" (140 x 200 cm)
- U.K. King 5' x 6'6" (152 x 198 cm)
- 5'3" x 6'7" (160 x 200 cm)
- 5'11" x 6'7" (180 x 200 cm)
- U.K. king Super King 6' x 6'6" x 8.5" (183 x 198 cm)
- 6'7" x 6'7" (200 x 200 cm)

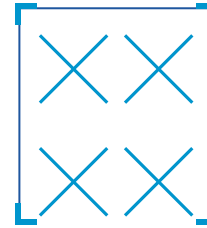

Bed sizes

- 3'11" x 6'11" (120 x 210 cm)
- 3'11" x 7'3" (120 x 220 cm)
- 4'7" x 6'11" (140 x 210 cm)
- 4'7" x 7'3" (140 x 220 cm)
- American Queen 5' x 7' x 8.5" (152 x 213 cm)
- 5'3" x 6'11" (160 x 210 cm)
- 5'3" x 7'3" (160 x 220 cm)
- 5'11" x 6'11" (180 x 210 cm)
- 5'11" x 7'3" (180 x 220 cm)
- American King 6' x 7' x 8.5" (183 x 213 cm)
- 6'7" x 6'11" (200 x 210 cm)
- 6'7" x 7'3" (200 x 220 cm)

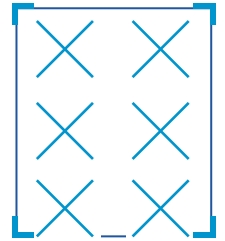

Placement of baseplates

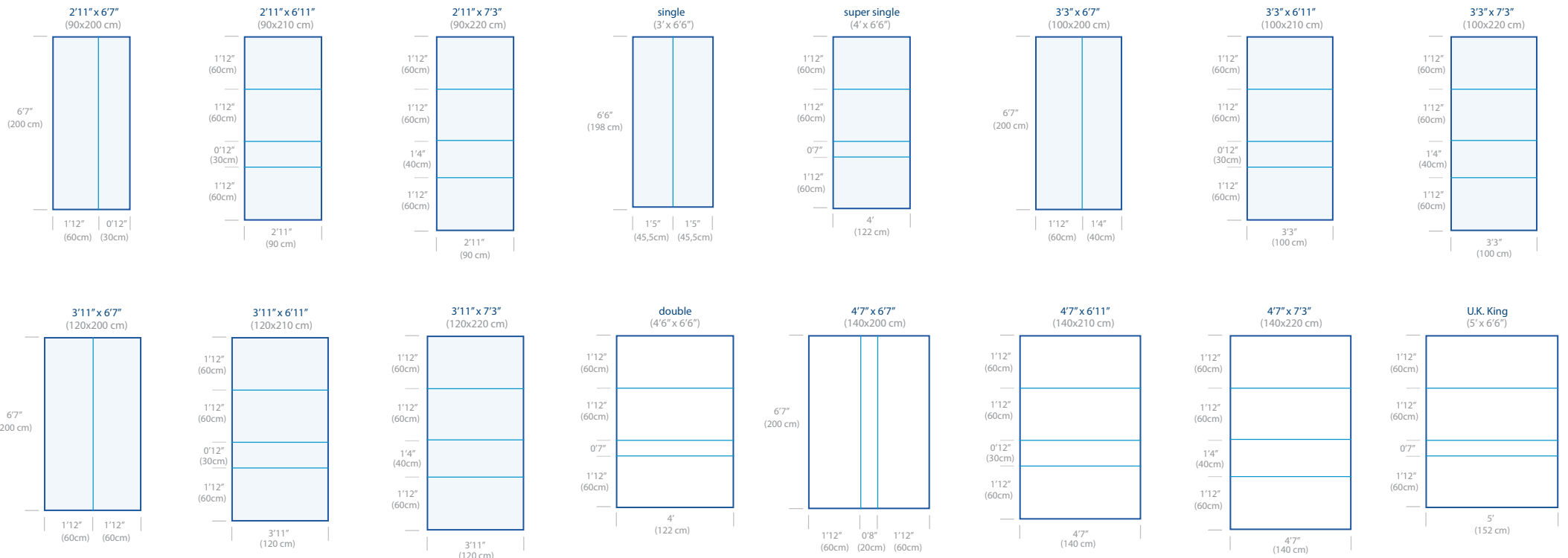



Skirting sizes

2'11" (90 cm)	1'12" (60cm) skirting size
3' (91 cm)	2'0" (61cm) skirting size
3'3" (100 cm)	2'4" (70cm) skirting size
3'11" (120 cm)	2'11" (90cm) skirting size
4' (122 cm)	3'0" (92cm) skirting size
4'6" (137 cm)	3'7" (107cm) skirting size
4'7" (140 cm)	3'7" (110cm) skirting size
5' (152 cm)	4'0" (122cm) skirting size
5'3" (160 cm)	4'3" (130cm) skirting size
5'11" (180 cm)	4'11" (150cm) skirting size
6' (183 cm)	5'0" (153cm) skirting size
6'6" (198 cm)	5'6" (168cm) skirting size
6'7" (200 cm)	5'7" (170cm) skirting size
6'11" (210 cm)	6'3" (190cm) skirting size
7' (213 cm)	6'0" (183cm) skirting size
7'3" (220 cm)	6'3" (190 cm) skirting size

The baseplates protrude approximately 15 cm from the skirting boards.

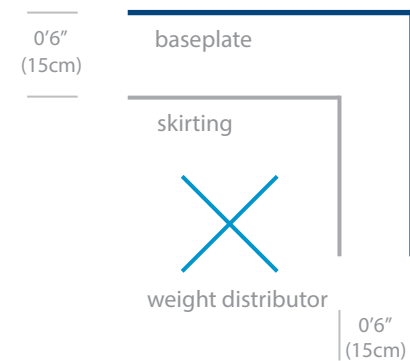

Please note! Only on the 6'11" (210 cm) bed size do the baseplates protrude 0'4" (10 cm) at the head of the bed and 0'4" (10 cm) at the foot.

Silvano waterbed warranty

When you buy a Silvano waterbed and (one or more) below items/accessories, you are guaranteed an excellent asset covered by a warranty of many years:

	warranty		
	2 years	5 years	10 years
EN71water mattress seams and vinyl messamoll2			✓
Heating elements		✓	
Safety lining, cover, foam border	✓		
Base and optional bedroom furnishings	✓		
Duvets, pillows	✓		
Linen: duvet covers, fitted sheets	✓		

Scope of warranty

Seams:

We are so convinced of the quality of our products that we offer a 10-year warranty on the durability of the seams on the Silvano water mattress. In the event of leaks resulting from material or manufacture faults, you are covered by a 100% warranty for the first five years. From the 6th to the 10th years, the warranty amounts to 50%, 40%, 30%, 20% and 10% respectively.

Safety lining, cover, foam border, base and optional bedroom furnishings:

100% warranty covering material and manufacture faults for 2 years.

Heating elements:

There is a straightforward 5-year manufacturer warranty that covers heating systems. The warranty conditions of the relevant manufacturers apply.

Other products:

Linen is covered by a two-year warranty. This obviously excludes wear-and-tear resulting from regular use.



Warranty period

The warranty period commences as of the date on the purchase invoice. To claim on the basis of this warranty, the buyer must be able to produce proof of purchase that clearly displays the purchase date. The warranty cannot be transferred to a different party.

This warranty is exclusively offered on condition that the installation instructions are followed and the product receives regular care. Replaced and repaired goods are likewise covered by the ongoing warranty. In case of repairs or the replacement of components, the warranty period will not be extended or renewed. If damage cannot be repaired, Silvano will replace the item with an identical or equivalent product within the warranty period.

Warranty stipulations

Silvano is committed to correcting material and manufacture faults in accordance to what has been stipulated in the section 'Scope of warranty'. If a product is no longer available, Silvano reserves the right to supply an equivalent product as a replacement.

Warranty limitations

Damage, resulting directly or indirectly from improper use, incorrect operation, excessive load, incompetent installation or relocation, repairs or modifications carried out by the buyer, and defects resulting from regular wear-and-tear or from inadequate care, are not covered by the warranty. Care implies the biannual addition of Silvano conditioner to the water in the water mattress and cleaning of the mattress every two months using special Silvano cleaner. You are, in any event, advised to safeguard your purchase invoices for these products. If you take advantage of the automatic Silvano care products delivery service, your orders are registered in our system and it is not necessary for you to keep your purchase documents.

The above warranty stipulations in no way affect the legal guarantee period to which you as a consumer are entitled to in accordance with European directives.

The Silvano logo is written in a blue, cursive script font.

Contact

Silvano Online GmbH

Wehrstr. 28
4689 Suderwick

Jurisdiction: Coesfeld
Chamber of Commerce : HRB14497 (DE)
VAT number: DE289507183
Tax number: 307/5707/1116

Availability

Weekdays from 8 am to 9 pm
Saturdays from 8 am to 8 pm
Email: info@silvanowaterbeds.co.uk

Care and hints

To extend the lifespan of your waterbed, we recommend that you urgently follow the below care instructions.

Air extraction

Once your waterbed has been installed and the mattresses are filled with (oxygenated) water, it is important that you frequently extract the air from the water mattresses over the period of a few weeks. Air bubbles are revealed by a sloshing sound made by the water! This means that it is time to take action.

Method

To remove the air from your water mattress, you use a special pump called an Air Extractor. This pump fits the fill nozzle. You can extract the air from the waterbed by pushing the air from the head of the mattress towards the fill nozzle. By pumping it out with the Air Extractor, you remove any air that might be present. Do this once a week over 3 to 4 weeks after installation of your waterbed. This will ensure that the water mattress is completely free of air, which will restrict bacterial growth or leaks to a minimum.

Vinyl cleaner

Our waterbeds are made of a vinyl film that requires simple care once every month using our vinyl cleaner. You can do this by spraying the cleaner onto the water mattress and rubbing it in until absorbed. Doing this will keep the water mattress supple and clean and will prevent the vinyl from perishing.

Attention: Do not use general cleaning substances for the care of your water mattress!

Conditioner

To keep the quality of the water in your mattress at ideal levels, conditioner must be added to the water every six months. As a rule, the water should never need replacement.

Method

Before adding the conditioner, pull the fill nozzle out of the mattress and remove the cap. At the same time, carefully push down the mattress around the fill nozzle to keep the water level high in the nozzle and prevent air from entering the mattress. Then add the contents of a bottle of conditioner, close the fill nozzle and push it back into the mattress. If you have a Duo-waterbed system, divide the contents of a bottle of conditioner between both mattresses.

Unpleasant odours

Odours can occur when the biological balance of the water is disturbed or if conditioner is not added according to instructions. The use of care substances other than the recommended vinyl cleaner can also cause odours.

Method

If you notice that your water mattress has an unpleasant odour, we recommend that you drain the mattress, refill it and then drain and refill it again. Then you must, of course, extract the air from your waterbed over a period of 3 to 4 weeks as described above.



Draining the water mattress

It may become necessary to drain your water mattress. We recommend that two persons take on this task and that you consult the user manual supplied with your water mattress. You can use our special waterbed pump to safely and efficiently drain your waterbed. It is also possible to use a drill pump (not battery-powered). Different fill hoses are available for both systems. Below, we briefly explain how to drain your waterbed.

Method

Remove the plug from the socket to disable the heating system, remove the mattress cover, extract the air from the water mattress and then connect the pump and hose. Make sure that the hose is long enough to reach as suitable drain outlet. Turn on the pump.

Your water mattress will be empty once the suction has created an airtight vacuum. This has been achieved when the upper and lower vinyl layers have been sucked tightly together. Then, you can disconnect the hose and quickly replace the cap on the fill nozzle. Make sure that the mattress does not fill itself with air again!

Mattress cover

The mattress cover must regularly be washed and aired. It is not intended to directly be slept on and must always be covered with a fitted sheet. We recommend that duvets are pulled back every morning to release possible condensation.

Leaks

Silvano waterbeds are made in such a way that there is no reason to fear serious leaks. If a small leak does occur, the water is contained within the safety lining. You can simply repair minor leaks yourself with the help of our special repair kit, and without the need to drain the waterbed.

Method

Remove the plug from the socket to disable the heating system. Then try to trace the leak by systematically checking the entire water mattress. Do this by pressing every section down by 0'4" (10 cm) to 0'6" (15 cm) to make the edge bulge slightly. Once you have located the leak, you can mark it and repair it with a drop of adhesive in case of a small hole, or a glued patch in case of a larger hole. Allow the adhesive to dry properly.

