

Users' Manual

Wellness Steam Shower Cabins (S8)

Please read the user's manual carefully before using the product.

INDEX

- ▶ Operating Environment
- ▶ Safety Notes
- ▶ Parameter for Steam Cabin
- ▶ Parts Information
- ▶ User's Manual
- ▶ Steam Generator Cleaning
- ▶ Trouble Shooting
- ▶ Self-diagnosis
- ▶ Circuit Diagram

OPERATING ENVIRONMENT



Water supply:

- Water heater with tank of 300L hot water capacity is suggested.
- Instant water heater is not suggested since it will affect system stability.
- Water volume: > 15L/MIN
- Water pressure: 200KPa (2Bar; 0.2MPa) ----600KPa (6Bar; 0.6MPa)
- Hot water temperature: 40°C (104F) ----80°C (176F)
- Environment temperature: 1°C (34F) ----40°C (104F)

Power supply:

- Power supply must be in accordance with local requirement.
- Power supply must meet power load requirement for product.

SAFETY NOTES



1. The power supply must be installed according to the local standard and with GFCI (Ground Fault Current Interrupter). Test the GFCI before using to confirm its security and validity.
2. The earthing for electrical appliances should be connected to fixed earth wire forever.
3. To avoid electric shock, replacing of power supply wire should be done by professional electrician or distributor. User should not change it by himself.
4. To avoid electric shock, no extending power supply should be used. The socket should be in right position. Broken electric wire should be changed in time.
5. It's forbidden to make any change, adding or cutting to the product.
6. It's forbidden to use the product after drinking or taking hypnotic medicine.
7. Children should use the product under custody from adults.
8. Adjust the low water temperature to high water temperature slowly to avoid scald.
9. Stop using the product in case user feels uncomfortable.

Parameter for Steam Cabin

Rated Power: 3.0KW 4.5KW

Rated Voltage: Single Phase AC220V Double Phase AC240V
 Single Phase AC110V

Rated Electric Current: 16A 20A

Frequency: 60Hz 50Hz

Power Supply Location: on wall on floor

Rated Water Pressure: 0.2--0.6 MPa

Water Supply: DN15 tie-in, hot/cold water

Water Supply Location: on wall on floor

Diameter of Drainage Pipe: ϕ 50 (drainage pipe supplied with product)

Length of Drainage Pipe: 1000mm (the maximum length after stretched)

Water temperature adjusting range: cold water temperature ~ 54°C (129F)

Water temperature adjusting precision: $\pm 0.5^\circ\text{C}$ (1F)

Best water temperature adjusting range: 30°C (86F) ----49°C (120F)

Parts Information

● LCD DISPLAY

1. Fahrenheit degree
2. Celsius degree
3. Temperature
4. Temperature indicator
5. Time setting
6. FM radio frequency
7. FM radio volume
8. FM radio channel
9. Chromotherapy on/off
10. Ventilator on/off
11. Steam on/off
12. Water flow indication
13. FM radio frequency
14. Mp3 on/off

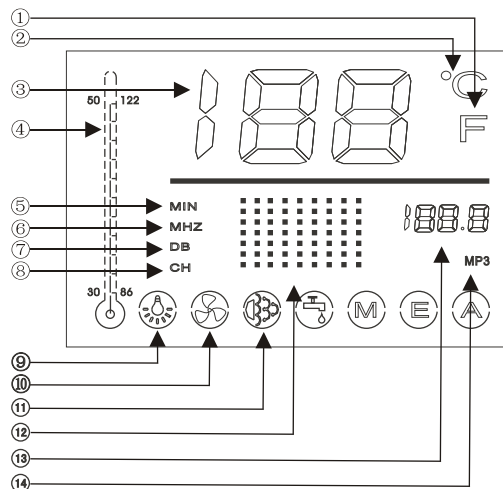

Parts Information

● Control Panel for Steam Cabin

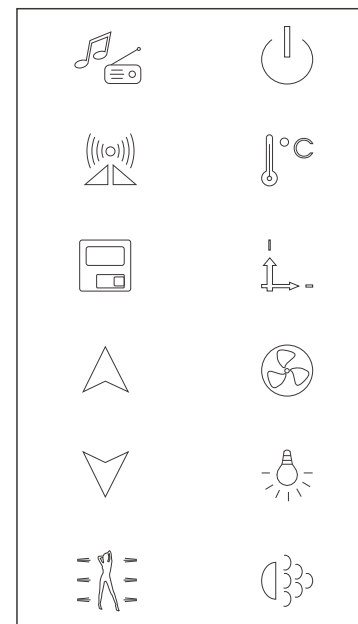

- Power on/off
- Steam temperature setting
- Steam time setting
- Ventilator
- Chromotherapy
- Steam on/off
- MP3/Radio on/off
- Volume/Frequency
- Radio memory
- + adjustment
- adjustment
- Shower mode

● Control Parts Information for Steam Cabin

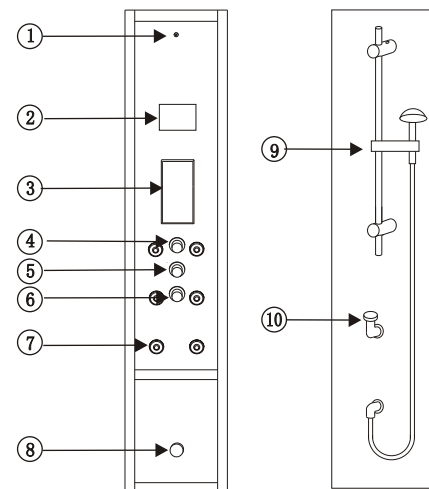

- ① Steam Temperature Sensor
- ② LCD Display
- ③ Control Panel
- ④ Water Diverter
- ⑤ Vitamin Dispenser
- ⑥ Faucet On/Off & Water Volume Control
- ⑦ Back Massage Jet
- ⑧ Steam Outlet
- ⑨ Hand Shower Set
- ⑩ Steam Generator Cleaning Liquid Inlet

POWER ON/OFF

Power on: The system is awaiting on when this button is pushed and the LCD screen shows like picture (1). Push this button again to start the system and the LCD screen shows like picture (2). The LCD screen shows the preset temperature. The user could make any operation to the system now. The system will be shut off automatically when it reaches the set time. (The default time setting is 60 minutes if the user has not set time otherwise). Turn volume control knob on and the system will be started automatically. However, it is not suggested to turn on water volume control knob before turning on control panel, because the system need 5 seconds for initializing after water volume control knob is turned on. While initializing some functions can not be used. So it is suggested to turn on control panel first before turning on water volume control knob unless there is no need to change any setting while initializing.

Power off: Turn volume control knob off and push power on/off button. Then the system will be shut off. Please note that the system can not be shut down if volume control knob is on. The drain valve keeps on for 1 minute after the system is turned off to drain the water in steam generator and plumbing.

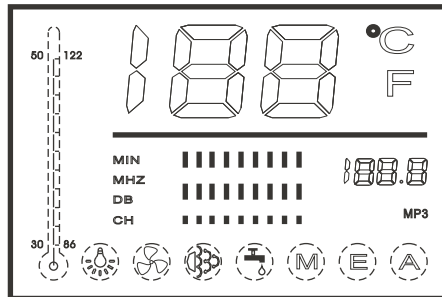

Picture 1

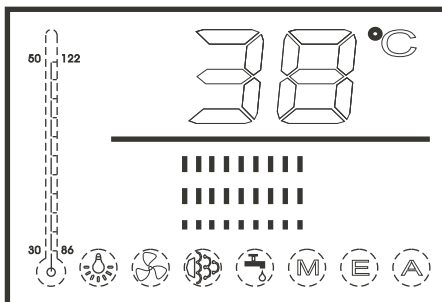

Picture 2

When the control panel is turned on, the display indicates the preset water temperature. Touch this button directly to increase/decrease preset water temperature.

When preset water temperature increases to 38°C, preset temperature can not be increased unless steam temperature setting button is touched. Touch  button again to increase preset water temperature higher than 38°C.

When the water volume control knob is on, the system starts to adjust water temperature to preset water temperature. The display now shows the instant water temperature through faucet. Water flow indication on display moves and indicates that water is flowing. Water will not come out into the cabin at this time because the system drains out water with incorrect temperature from the piping system first. After all cold water in the piping system drains out, the system needs 5~20 seconds to adjust water temperature to the preset water temperature. Water comes out into the cabin until the water temperature reaches the range of $\pm 2.5^\circ\text{C}$ plus preset water temperature. When water comes out, the display shows the instant water temperature through faucet.

While water is out, push this button directly to increase/decrease preset water temperature.

It may happen that water will not come out into cabin a few minutes after water volume control knob is turned on. In this case there is not enough hot or cold water supply (That can be judged by the instant water temperature indicated on the display). Please check hot/cold water supply or change the preset water temperature.

In case the temperature of water through faucet is out of range of $\pm 4^\circ\text{C}$ plus preset water temperature, the system will cut off water supply immediately and water will be drained out until the system gets the right temperature. Please note that water is still flowing as long as water flow indication is moving on the display, even though there is no water coming out into the cabin. Please make sure water volume control knob is off when nobody is using the shower. The control panel can not be shut down unless the volume control knob is turned off.

When FM Radio is on and button TUN/VOL is pushed, user can push this button to increase/decrease radio volume or frequency.

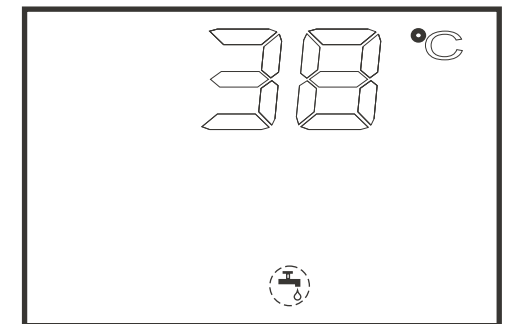

Steam temperature setting

Keep on pushing this button and picture 3 shows on display. The figure of temperature is changing from 20 to 59 circularly. Loosen the button when the figure reaches the desired temperature and the figure is set as steam setting temperature. The steam generator stops working when the temperature inside steam cabin is 2°C/4F higher than setting temperature. The steam generator starts working automatically when the temperature is 2°C/4F lower than setting temperature. The default steam setting temperature is 45°C/113F if the user does not make any steam temperature setting.

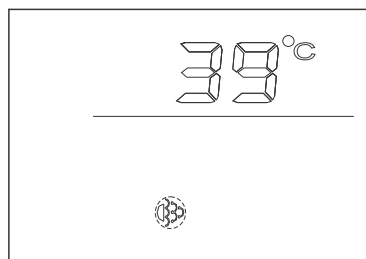

Picture 3

Steam time setting

Keep on pushing this button and picture 4 shows on display. The figure is changing from 20-59 circularly. Loosen the button when the figure reaches the desired one and the figure is set as working time for system.

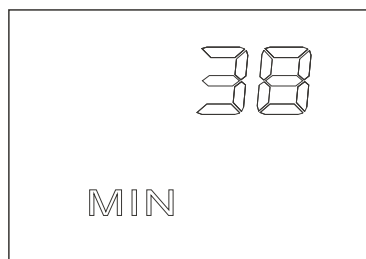

Picture 4

The system is automatically shut off when the working time reaches the setting time. The default working time is 45 minutes if the user does not make setting for working time of steam sauna.

Chromatherapy

This button controls the color of chromatherapy lamps (picture 5). When chromatherapy function starts, the lamp symbol on LCD display twinkles (picture 5).

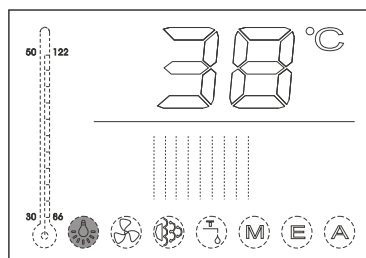

Picture 5

Ventilator

- This button turns ventilation on/off. When ventilation is on, the ventilation symbol on LCD display twinkles.

- Celsius/Fahrenheit Conversion
Keep on pushing this button for at least 10 seconds to make conversion between Celsius degree and Fahrenheit degree. And the picture is changing between picture 7 and picture 8.

Steam on/off

This button turns steam on/off. Push this button, the steam symbol is twinkling on LCD display. The steam function is automatically turned off when the temperature inside steam cabin is 2°C higher than the set temperature. And the steam function will be turned on automatically when the temperature inside steam cabin is 2°C lower than the set temperature.

FM/MP3 radio on/off

MP3 Setting:

- Set frequency for Mp3 emitter: Select a frequency without FM radio signal as frequency for Mp3 emitter.
- Start MP3 function.
- Adjust frequency of FM radio to get the same frequency as that of MP3 emitter.
- Adjust volume of FM radio. It will be set as the default volume of MP3.
- Push  button for over 3 seconds to finish setting.

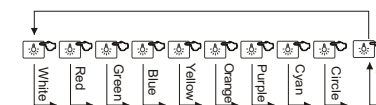

Picture 6

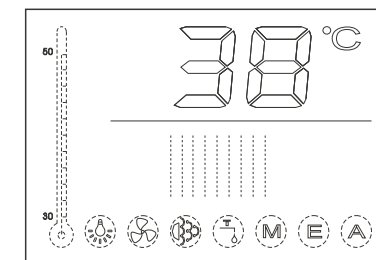

Celsius degree Picture 7

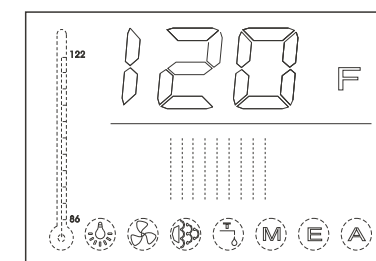

Fahrenheit degree Picture 8

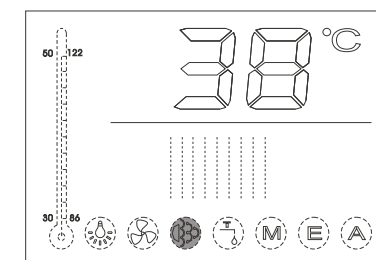

Picture 9

Radi/MP3 on/off

● Push this button and picture 11 shows on the display. And FM radio is on. The radio frequency by default is the same as the radio frequency selected last time. Push this button again to start Mp3 receiving function and the receiving frequency is automatically set as setting frequency for Mp3. Push this button again to turn off FM radio and Mp3.

Volume/Frequency adjustment

● Volume adjusting:

Push this button when FM radio is on and picture 12 shows on the display. Push  button again to adjust volume.



● Frequency adjusting:

Push this button twice when FM radio is on and picture 13 shows on the display. Push  button again to adjust frequency.

Channel Memory

Channel Memory Setting:

● Start FM radio

● Set serial number: push  button shortly and picture 14 shows on display; push  button shortly again, figure from 1 to 8 shows circularly; stop pushing this button when the wanted figure shows.

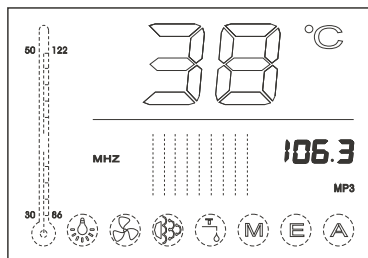

Picture 10

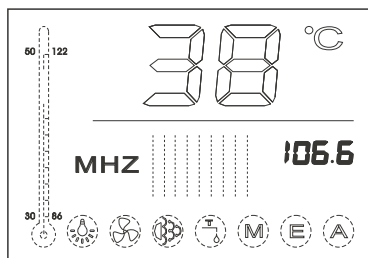

Picture 11

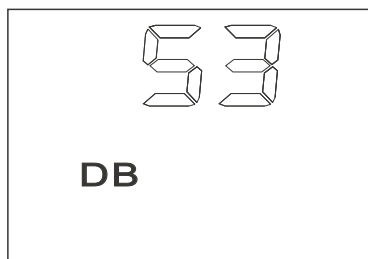

Picture 12

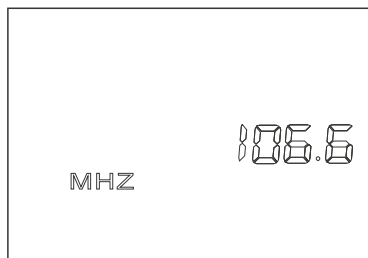

Picture 13

● Adjust FM radio to your favorite channel; push  button to adjust frequency and volume.

● Channel Memory: Push  button for more than 3 seconds; the figure shows +1 and turns to original setting serial number. Stop pushing this button to finish setting for one channel. If the serial number is used for another channel, this channel will be replaced by the new channel in memory.

● Repeat the above steps to get the favorite channels in memory. At most 8 channels can be in memory.

● Locate channel:

Start FM radio. Push  button shortly to find right channel in memory.



+ adjustment

- adjustment

● Adjust frequency/volume:

after pushing  button, push the above 2 buttons to adjust frequency and volume.

● Push the 2 buttons to set water temperature for shower:

push  button first and then push  button if the set water temperature is more than 38°C (100F).

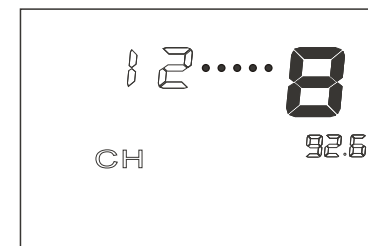

Picture 14

☰ : SHOWER MODE

Touch this button to select different shower mode. The first touch indicates the present mode. Touch mode button again to change mode setting to M1, M2, M3, M4, M0 in turn.

The default mode setting is M0. M0 is for use of hand shower and ceiling shower. Turn water diverter to the position of hand shower or ceiling shower to use hand shower or ceiling shower. Please turn water diverter to the position of jets to enjoy different shower mode from jets. If water diverter is at the position of jets and mode status is M0, there is no water coming out from jets.

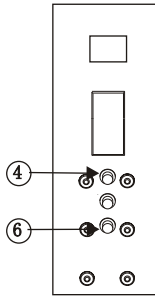

● SHOWER MODE FOR TYPE S8A

● Hand Shower: select M0 as shower mode (it is default mode) and turn water diverter to HAND SHOWER.

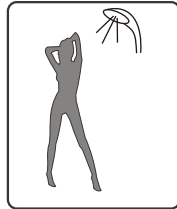
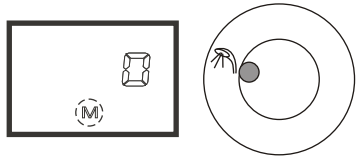

● Ceiling Shower: select M0 as shower mode (it is default mode) and turn water diverter to CEILING SHOWER.

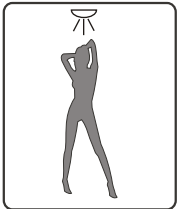
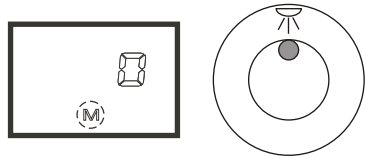

● All Back Hydro-Massage Jets On Mode: select M1 as shower mode to enjoy hydro-massage from all back jets.

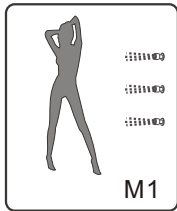
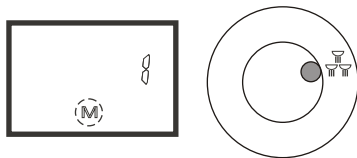

● Circular Hydro-Massage Mode: select M2 as shower mode to enjoy circular hydro-massage from back jets.

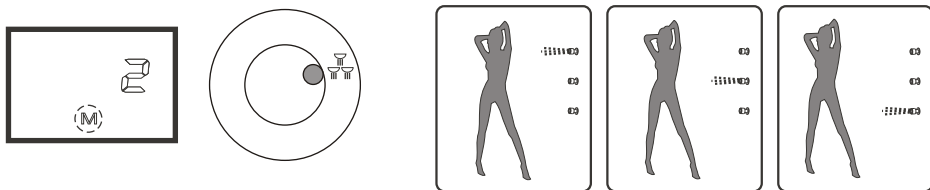

● Pulsating Hydro-Massage Mode: select M3 as shower mode to enjoy pulsating hydro-massage from back jets.

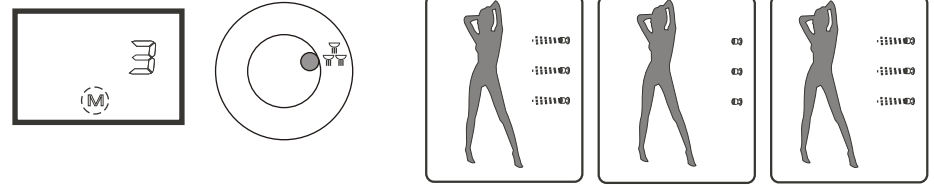

● Scottish Shower Mode: select M4 as shower mode to enjoy Scottish shower. Scottish shower consists of the alternation of warm and cold water streams. Hot water stream lasts for 30 seconds and cold water lasts for 10 seconds. The system uses the preset water temperature as the temperature of hot water stream. The temperature of hot water can be adjusted through up and down button. Scottish shower stimulates the opening and closing of skin pores and increases skin elasticity. Hot water relieves muscle tension and activates blood circulation, while cold water induces contraction of the tissues. In this way, the capillaries get a good exercise. The skin circulation improves and it becomes more supple and toned.



● SHOWER MODE FOR TYPE S8B

● Hand Shower: select M0 as shower mode (it is default mode) and turn water diverter to HAND SHOWER.



● Ceiling Shower: select M0 as shower mode (it is default mode) and turn water diverter to CEILING SHOWER.



● All Back Hydro-Massage Jets On Mode: select M1 as shower mode to enjoy hydro-massage from all back jets from one column.

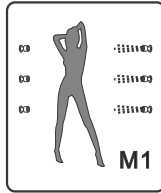
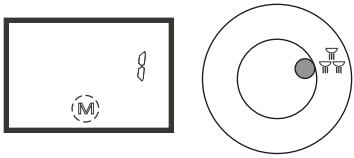

● Circular Hydro-Massage Mode(1): select M2 as shower mode to enjoy circular parallel hydro-massage from back jets.

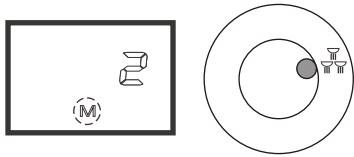

● Circular Hydro-Massage Mode(2): select M3 as shower mode to enjoy circular opposite hydro-massage from back jets.

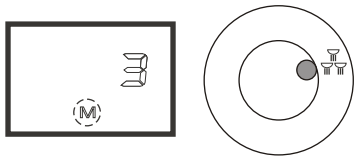

● Pulsating Hydro-Massage Mode: select M4 as shower mode to enjoy pulsating hydro-massage from back jets.

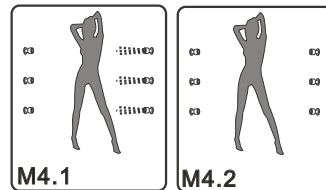
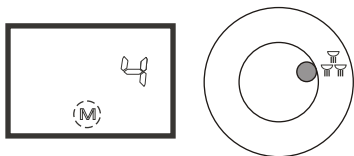

● Scottish Shower Mode: select M4 as shower mode to enjoy Scottish shower. Scottish shower consists of the alternation of warm and cold water streams. Hot water stream lasts for 30 seconds and cold water lasts for 10 seconds. The system uses the preset water temperature as the temperature of hot water stream. The temperature of hot water can be adjusted through up and down button. Scottish shower stimulates the opening and closing of skin pores and increases skin elasticity. Hot water relieves muscle tension and activates blood circulation, while cold water induces contraction of the tissues. In this way, the capillaries get a good exercise. The skin circulation improves and it becomes more supple and toned.

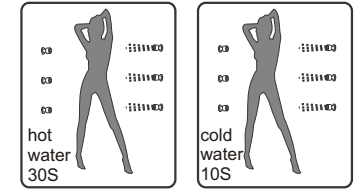
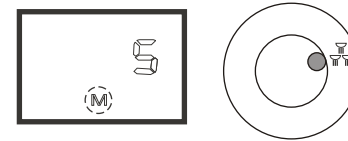

● SHOWER MODE FOR TYPE S8C

● Hand Shower: select M0 as shower mode (it is default mode) and turn water diverter to HAND SHOWER.

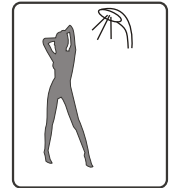
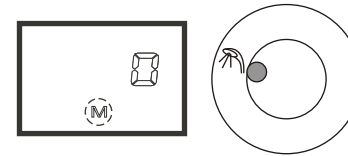

● Ceiling Shower: select M0 as shower mode (it is default mode) and turn water diverter to CEILING SHOWER.

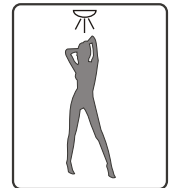
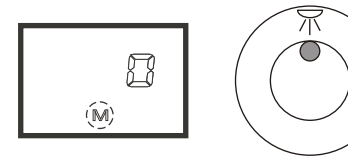

● All Back Hydro-Massage Jets On Mode: select M1 as shower mode to enjoy hydro-massage from all back jets from one column.

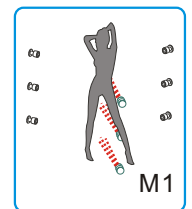
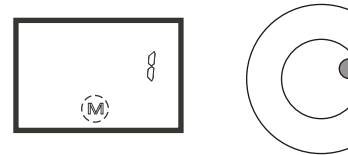

●Circular Parallel Hydro-Massage Mode: select M2 as shower mode to enjoy circular parallel hydro-massage from back jets.

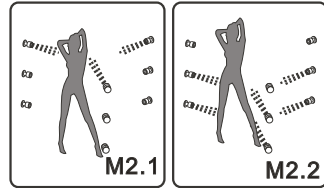
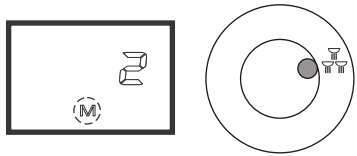

●Circular Opposite Hydro-Massage Mode: select M3 as shower mode to enjoy circular opposite hydro-massage from back jets.

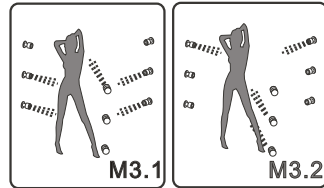
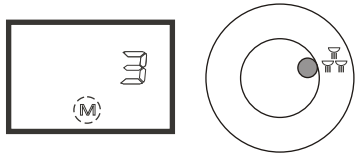

●Pulsating Hydro-Massage Mode: select M4 as shower mode to enjoy pulsating hydro-massage from back jets.

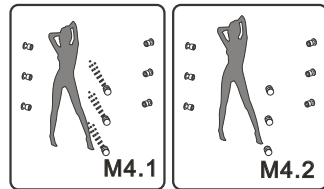
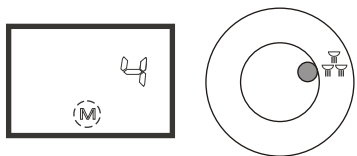

● Scottish Shower Mode: select M4 as shower mode to enjoy Scottish shower. Scottish shower consists of the alternation of warm and cold water streams. Hot water stream lasts for 30 seconds and cold water lasts for 10 seconds.

The system uses the preset water temperature as the temperature of hot water stream. The temperature of hot water can be adjusted through up and down button. Scottish shower stimulates the opening and closing of skin pores and increases skin elasticity. Hot water relieves muscle tension and activates blood circulation, while cold water induces contraction of the tissues. In this way, the capillaries get a good exercise. The skin circulation improves and it becomes more supple and toned.

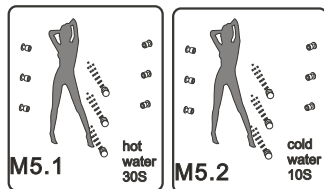
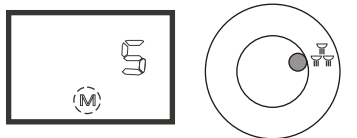

● on/off control & water volume control

To turn on: Turn the control knob anticlockwise to turn on the faucet and the digital thermostatic control system is turned on automatically. The default water temperature is the preset temperature for last use. Water volume becomes bigger if the diverter is turned more anticlockwise.

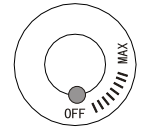

On/off control water volume control

To turn off: Turn the control knob to the end clockwise to turn off the faucet. The control system could not be turned off unless the faucet is turned off. The shower mode is automatically changed to M0 when the faucet is turned on again. Water will come out from jets only when shower mode is on and the diverter is turned to JET location.



Vitamin dispenser

Note: The sensor must be in vertical downward location when the diverter is turned clockwise to the end. Otherwise, the system could not be turned on/off.

●How to use Vitamin shower:

How to put in Vitamin

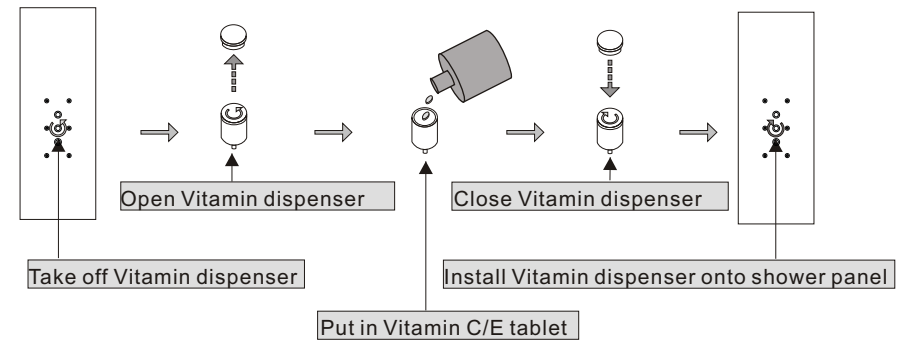

●How to use Vitamin shower

Vitamin C tablet could be put into Vitamin dispenser directly; Vitamin E tablets usually has gel coat which should be punctured before it's put into Vitamin dispenser; Please take out Vitamin C/E tablet if the shower is not used for a long time; Other skin care materials such as olive oil could be put into the dispenser as well.

●How to use diverter

When the diverter is turned to HAND SHOWER/CEILING SHOWER location, the shower mode should be set as M0; When the diverter is turned to JET location, the shower mode could be set as M1~M5.

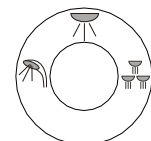

Diverter

Steam Generator Cleaning

Remove the cover of cleaning liquid inlet and input around 1L of citric acid or acetic acid. Then start steam function to fill steam generator with water. Stop steam function before steam coming out (acid steam has causticity to plated parts. If a lot of acid steam come out, the plated parts become cloudiness after some time.) Do not shut off the control system and keep it on. The scale in the steam generator dissolves in acid liquid and the system drains the dirty water out automatically after 60 minutes. Clean the steam generator every 3 months.

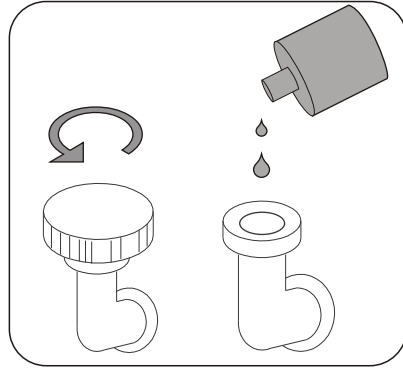

Trouble Shooting for Steam Cabin



| TROUBLE | CAUSE | SOLUTION |
|--|---|--|
| Water temperature abnormal; water keeps coming out from drainage pipe. | 1.Hot/cold water inlet pipe is wrongly connected. | Connect hot/cold water inlet pipe according to mark. |
| | 2.Motor/digital thermostatic mixer damaged | Replace motor or mixer |
| | 3.Water pressure difference between hot/cold water is too big. | Install reductor at water supply which has too big pressure. |
| | 4.Preset water temperature is too high or too low compared to the temperature of hot/cold water supply. | Reset the preset water temperature. |
| Steam generator keeps adding water. | 1.The water inlet electro-magnetic valve is wrong. | Replace water inlet valve |
| | 2.Water level sensor could not detect signal. | Clean scale on water level sensor or replace it. |
| Power supply is off when on/off button is pushed. | 1.There is creepage from heater. | Replace heater. |
| | 2.There is creepage from thermal switch inside heater. | Replace thermal switch. |
| Water leaks from valve. | 1.The seal is damaged. | Change the seal. |
| Water flow volume is low. | 2.Water supply has impurities and jammed the filter net. | Get filter net cleaned. |
| Touch panel does not work. | 1.Communication line is short circuit or open circuit. | Check connection between control panel and power box. |
| | 2.The control system is wrong. | Change control panel or power box. |

Trouble Shooting for Steam Cabin

| TROUBLE | CAUSE | SOLUTION |
|---|---|--|
| No Steam | 1.The water supply is shut off. | Turn on the water supply valve. |
| | 2.No water supply in this area. | Use the product when water supply is normal. |
| | 3.The water inlet valve cannot be turned on. | Check water inlet valve and output signal from it. |
| | 4.The water level sensor is wrong. | Clean scale on water level sensor or replace it. |
| | 5.Thermal switch in the heater is wrong. | Change thermal switch installed inside the heater. |
| | 6.The heater is wrong. | Change the heater. |
| | 7.The set temperature is lower than room temperature. | Reset temperature. |
| No water comes from hand shower or ceiling shower | 1.The diverter is not in right location. | Turn diverter to right location. |
| | 2.Electro-magnetic valve is loosen or damaged. | Get it connected or replaced |
| No water comes from jets. | 1.The diverter is not in right location. | Turn diverter to JET location and start shower mode. |
| | 2.Shower mode is not on. | Select shower mode M1-M5 |
| | 3.Electro-magnetic valve is damaged. | Change the valve. |

Self-diagnosis function for S8 control system

S8 control system has self-diagnosis function to help to find problem during maintenance.

Start self-diagnosis: push  button for 10 seconds to start inspection, push  or  button to scan all function parts inside control system one by one.

There are 14 steps as follows:

00----To check whether water fills into steambox properly. In normal condition, water filling should be stopped when the water level reaches the sensor and the display should indicate as picture 00 below. Otherwise there must be something wrong with that.

01---- To check whether water drains from steam generator properly. In normal condition, the electro-magnetic valve should be turned on and water should drain out from steam generator. The display should indicate as picture 01 below. Otherwise there must be something wrong with that.

02----To detect water level inside steam generator. This is only used by manufacturer.

03---- To check whether water heater inside steam generator works. In normal condition steam should come out from steam outlet after a few minutes.

04---- To check whether cold water plumbing is correct. In normal condition cold water should come out from hand shower or ceiling shower. If not, there must be something wrong. First please check whether cold water supply and hot water supply are connected properly. Second please check whether electromagnetic valve for right temperature is properly connected. Last please check whether electronic mixer works properly.

05----To check whether hot water plumbing is correct. In normal condition hot water should come out from the drain hose which is used to drain water with wrong temperature. If not, there must be something wrong. First please check whether cold water supply and hot water supply are connected properly. Second please check whether electromagnetic valve for wrong temperature is properly connected. Last please check whether electronic mixer works properly.

06----This is only used by manufacturer.

07----To check whether water comes out from electro-magnetic valve A. Water should come out from jets in normal condition.

08----To check whether water comes out from electro-magnetic valve B. Water should come out from jets in normal condition.

09----To check whether water comes out from electro-magnetic valve C. Water should come out from jets in normal condition.

10----To check whether water comes out from electro-magnetic valve D. Water should come out from jets in normal condition (S8A has no such function).

11----To check whether water comes out from electro-magnetic valve E. Water should come out from jets in normal condition (S8A has no such function).

12----To check whether water comes out from electro-magnetic valve F. Water should come out from jets in normal condition (S8A has no such function).

13---- To check whether electronic mixer works. In normal condition the display indicates from "OFF", "COL " and "HOT" to "HOT", "COL " and "OFF" in turn.

14----This is only used by manufacturer.

Pictures in accordance with above steps of diagnosis are as follows:

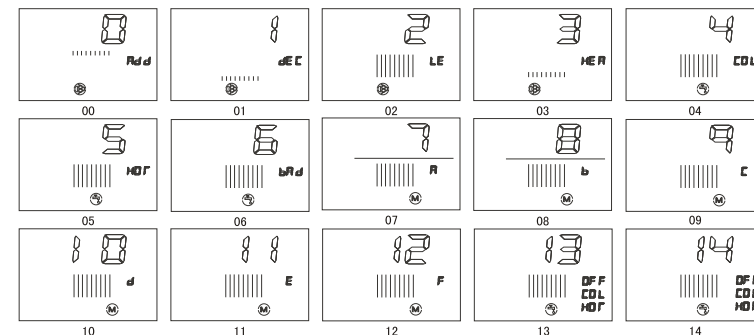

Circuit diagram for S8B/C

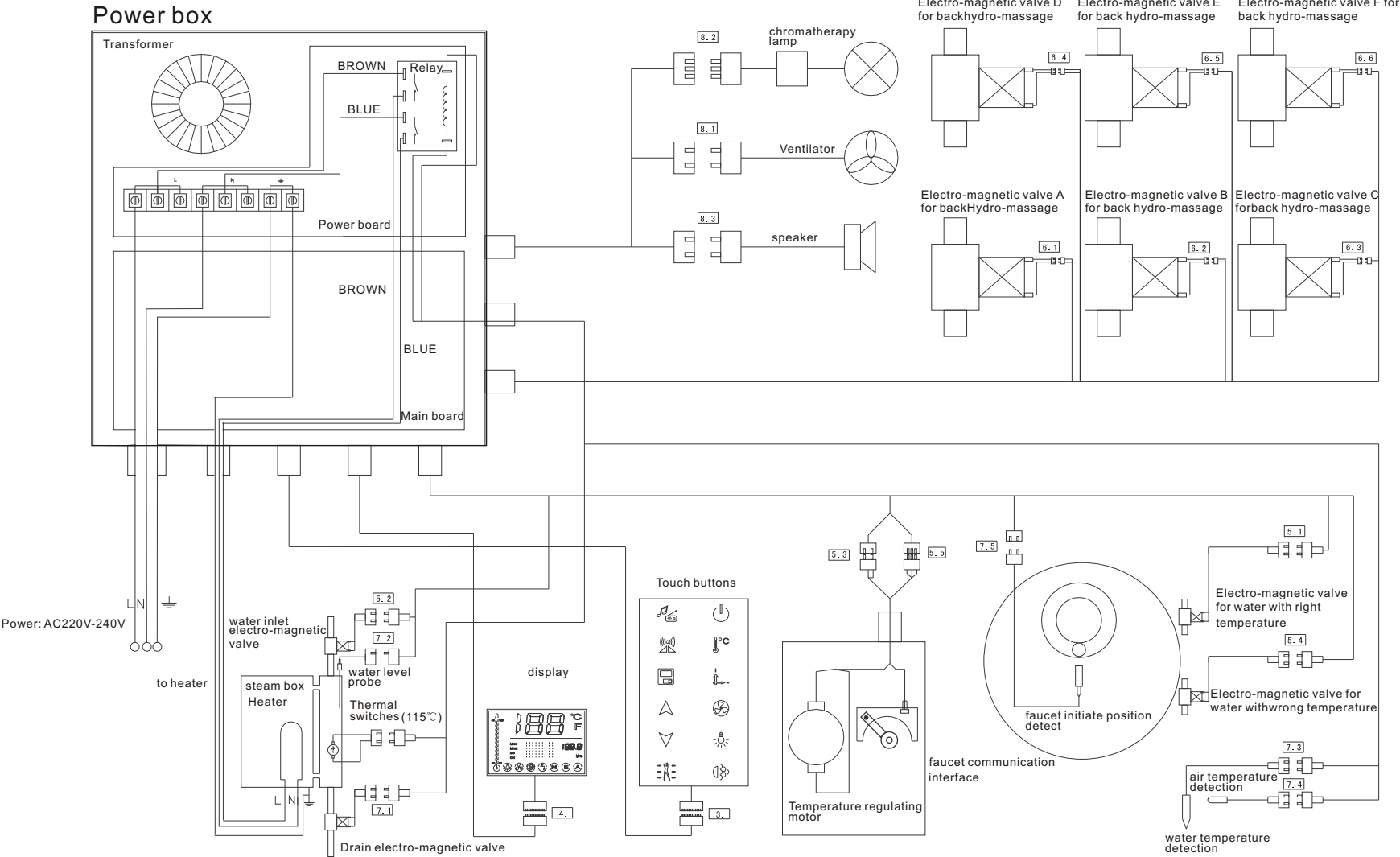

Circuit diagram for S8A

