

User Guide

Optima XE Series

Preparative Ultracentrifuges
For *In Vitro* Diagnostic Use

Rx Only



CE

PN B04155AC
January 2015



Beckman Coulter, Inc.
250 S. Kraemer Blvd.
Brea, CA 92821 U.S.A.

 **BECKMAN
COULTER**

**Optima XE
Ultra Centrifuge
User Guide**

PN B04155AC (January 2015)

© 2015 Beckman Coulter, Inc.
All rights reserved

Trademarks

Beckman Coulter, the stylized logo, and Optima are trademarks of Beckman Coulter, Inc. and are registered with the USPTO.

All other trademarks, service marks, products, or services are trademarks or registered trademarks of their respective holders.

Find us on the World Wide Web at:

www.beckmancoulter.com



Beckman Coulter Ireland, Inc.
Mervue Business Park, Mervue Galway, Ireland 353 91 774068

Printed in U.S.A.

Revision History

B04155AA, Initial Issue, 05/2011

Issue Version AB, 01/2014

Manual updated per Canadian Standards Association (CSA) guidelines.

Issue Version AC, 01/2015

Changes or additions were made to: [Getting Access to the Sample](#); [Restoring the Instrument to Operating Condition](#).

Note: Changes that are part of the most recent revision are indicated in text by a bar in the margin of the amended page.

This document applies to the latest software listed and higher versions. When a subsequent software version affects the information in this document, a new issue will be released to the Beckman Coulter website. For labeling updates, go to www.beckmancoulter.com and download the latest version of the manual or system help for your instrument.

Safety and Notices

This chapter presents the important notices that apply to the instrument and describes the conventions used in the document.

Alerts for Danger, Warning, Caution, Important, and Note

DANGER

DANGER indicates an imminently hazardous situation which, if not avoided, will result in death or serious injury. This signal word is to be limited to the most extreme situations.

WARNING

WARNING indicates a potentially hazardous situation which, if not avoided, could result in death or serious injury. May be used to indicate the possibility of erroneous data that could result in an incorrect diagnosis (does not apply to all products).

CAUTION

CAUTION indicates a potentially hazardous situation, which, if not avoided, may result in minor or moderate injury. It may also be used to alert against unsafe practices. May be used to indicate the possibility of erroneous data that could result in an incorrect diagnosis (does not apply to all products).

IMPORTANT **IMPORTANT** is used for comments that add value to the step or procedure being performed. Following the advice in the Important adds benefit to the performance of a piece of equipment or to a process.

NOTE **NOTE** is used to call attention to notable information that should be followed during installation, use, or servicing of this equipment.

Safety Notices

Before installing, using, or maintaining the instrument, be certain that you know all the following precautions.

Information

CAUTION

Read all product manuals and consult with Beckman Coulter-trained personnel before attempting to operate instrument. Do not attempt to perform any procedure before carefully reading all instructions. Always follow product labeling and manufacturer's recommendations. If in doubt as to how to proceed in any situation, contact your Beckman Coulter Representative.

Installation

CAUTION

This instrument is designed to be installed by a Beckman Coulter Field Service representative. Installation by anyone other than authorized Beckman Coulter personnel invalidates any warranty covering the instrument. Also, should the instrument need to be moved, a Beckman Coulter Field Service representative must reinstall and re-level the instrument in its new location.

WARNING

Do not place the ultracentrifuge near areas containing flammable or combustible fluids, or any other source of vapors that could enter the ultracentrifuge air system and be ignited by the motor.

WARNING

Ultracentrifuge operations generate high energy levels that require precautions against sudden movements that could result from the rare event of a rotor failure. Maintain a 30-cm. (1-ft.) clearance envelope around and above the ultracentrifuge. Do not install any equipment or furniture in this envelope. While the ultracentrifuge is running, keep the envelope clear of any persons or objects and do not reach into the envelope except when required to change operating controls.

Replacement Parts

 **WARNING**

Do not replace any centrifuge components with parts not specified for use on this instrument.

Service

 **WARNING**

Any servicing of this equipment that requires removal of any covers can expose parts which involve the risk of electric shock or personal injury. Make sure that the power switch is turned off, and the instrument is disconnected from the main power source, by removing its power plug from the receptacle. Refer such servicing to qualified personnel.

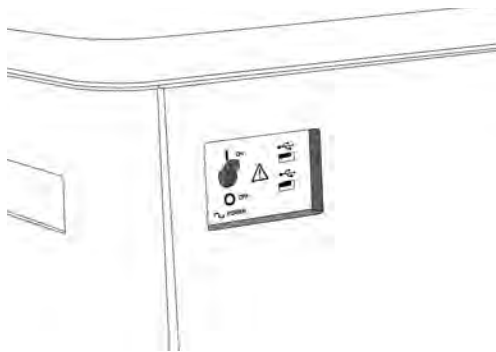

NOTE It is your responsibility to decontaminate the instrument and accessories before requesting service by Beckman Coulter Field Service.

Power Supply

 **DANGER**

To reduce the risk of electrical shock, this instrument uses a three-wire electrical cord and plug to connect this equipment to earth-ground. Make sure that the matching wall outlet receptacle is properly wired and earth-grounded.

Fuse Replacement

 **WARNING**

Fuses protect certain electrical circuits within this instrument against overcurrent conditions. The fuse is not customer replaceable. For continued protections, please contact Beckman Coulter Field Service.

Mechanical Safety



For safe operation of the equipment, observe the following:

- Use only the Beckman Coulter rotors and accessories designed for use in this instrument.
- Do not exceed the maximum rated speed of the rotor in use.
- NEVER attempt to slow or stop a rotor by hand.
- Do not move the centrifuge while the drive motor is spinning.
- In the event of a power failure, do not attempt to retrieve the sample from the instrument for at least one hour. Then follow the instructions for recovery of the sample in the [Maintenance and Troubleshooting](#) chapter.

Chemical and Biological Safety



Normal operation may involve the use of solutions and test samples that are pathogenic, toxic, or radioactive. Such materials require that you take all necessary safety precautions.

- Handle body fluids with care because they can transmit disease. No known test offers complete assurance that they are free of micro-organisms.
- Handle all infectious samples according to good laboratory procedures and methods to prevent spread of disease.
- Because spills may generate aerosols, observe proper safety precautions for aerosol containment.
- Some of the most virulent infectious agents—Hepatitis (B and C) and HIV (I-V) viruses, atypical mycobacteria, and certain systemic fungi—require additional emphasis on aerosol protection.
- Do not run toxic, pathogenic, or radioactive materials in a rotor without taking appropriate safety precautions.
- Risk Group II materials (as identified in the World Health Organization *Laboratory Biosafety Manual*) require biosafe containment. Materials of a higher group require more than one level of protection.
- Dispose of all waste solutions according to appropriate environmental health and safety guidelines.
- Do not centrifuge flammable or explosive vapors, or materials capable of hazardous chemical reactions.

Precautions with Liquids



Do not place containers holding liquid on or near the chamber door. Liquid, if spilled, may get into the instrument and damage electrical or mechanical components.

Volatile Liquids



This instrument is not designed for use with materials capable of developing flammable or explosive vapors, or hazardous chemical reactions. Do not centrifuge such materials (for example, chloroform or ethyl alcohol) in this instrument nor handle or store them near the centrifuge.

Certification

To ensure full system quality, Beckman Coulter Optima XEs have been manufactured in a registered ISO 9001 or 13485 facility. They have been designed and tested to conform to (when used with Beckman Coulter rotors) the laboratory equipment requirements of applicable regulatory agencies. Declarations of conformity and certificates of compliance are available at www.beckmancoulter.com.

Scope of Manual

This manual is designed to familiarize you with the Optima XE, its functions, specifications, operation, and routine operator care and maintenance. Read this entire manual, especially the safety notices and all safety-related information, before operating the instrument or performing maintenance.

NOTE If the instrument is used in a manner other than specified in this manual, the safety and performance of this equipment could be impaired. Further, the use of any equipment other than that recommended by Beckman Coulter has not been evaluated for safety. Use of any equipment not specifically recommended in this manual and/or the appropriate rotor manual is the sole responsibility of the user.

CFC-Free Centrifugation



To ensure minimal environmental impact, no CFCs are used in the manufacture or operation of the Optima XE ultracentrifuge.

Software Copyright

The software and other information incorporated into the Optima XE is protected by international copyright laws. Unauthorized copying, use, distribution, transfer, or sale is a violation of those laws that may result in civil or criminal penalties. This computer program is also subject to additional restrictions contained in the following Microsoft OEM Customer License Agreement for Embedded Systems:

“If you use the Device to access or utilize the services or functionality of Microsoft Windows XP Server (all editions), or use the Device to permit workstation or computing devices to access or utilize the services or functionality of Microsoft Windows XP Server, you may be required to obtain a Client Access License for the Device and/or each such workstation or computing device. Refer to the End-User License Agreement for Microsoft Windows XP Server for additional information.” The End-User License Agreement is available on the Microsoft Embedded Systems website.

Biohazard



If a hazardous substance such as blood is spilled onto the instrument, clean up the spill by using a 10% bleach solution, or use your laboratory decontamination solution. Then follow your laboratory procedure for disposal of hazardous materials. If the instrument needs to be decontaminated, contact your Beckman Coulter Representative.



Risk of chemical injury from bleach. To avoid contact with the bleach, use barrier protection, including protective eyewear, gloves, and suitable laboratory attire. Refer to the Safety Data Sheet for details about chemical exposure before using the chemical.

NOTE For Safety Data Sheets (SDS/MSDS) information, go to the Beckman Coulter website at www.beckmancoulter.com.

RoHS Notice

These labels and materials declaration table (the Table of Hazardous Substance's Name and Concentration) are to meet People's Republic of China Electronic Industry Standard SJ/T11364-2006 "Marking for Control of Pollution Caused by Electronic Information Products" requirements.

China RoHS Caution Label



This label indicates that the electronic information product contains certain toxic or hazardous substances. The center number is the Environmentally Friendly Use Period (EFUP) date, and indicates the number of calendar years the product can be in operation. Upon the expiration of the EFUP, the product must be immediately recycled. The circling arrows indicate the product is recyclable. The date code on the label or product indicates the date of manufacture.

China RoHS Environmental Label



This label indicates that the electronic information product does not contain any toxic or hazardous substances. The center "e" indicates the product is environmentally safe and does not have an Environmentally Friendly Use Period (EFUP) date. Therefore, it can safely be used indefinitely. The circling arrows indicate the product is recyclable. The date code on the label or product indicates the date of manufacture.

Summary of Instrument Labels

This section provides information for some labels and symbols appearing on the Optima XE instrument housing. These labels and symbols may be associated with user-serviceable procedures. Individual hazards associated with a specific procedure in this manual may use these labels and symbols, and are included in **Warnings** or **Cautions** within the procedures for that task.

Caution Symbol



This symbol indicates a caution message and appears adjacent to an explanation or other symbols that define the caution.

Universal Serial Bus (USB)

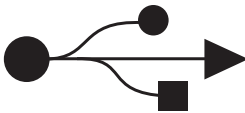

This symbol indicates the location of a universal serial bus (USB) connector.

Ethernet

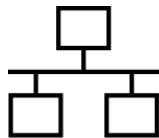

This symbol indicates the location of an ethernet connector.

Biohazard



This symbol indicates a biohazard.

Recycling Label



This symbol is required in accordance with the Waste Electrical and Electronic Equipment (WEEE) Directive of the European Union. The presence of this marking on the product indicates:

- the device was put on the European Market after August 13, 2005 and
- the device is not to be disposed of via the municipal waste collection system of any member state of the European Union.

It is very important that customers understand and follow all laws regarding the proper decontamination and safe disposal of electrical equipment. For Beckman Coulter products bearing this label, please contact your dealer or local Beckman Coulter office for details on the take-back program that will facilitate the proper collection, treatment, recovery, recycling and safe disposal of the device.

Multiple Compliance



This symbol indicates compliance with:

- IVD – For in vitro diagnostic use
- N395 – The C-Tick mark is intended for use on products that comply with Australian Communication Authority (ACA) EMC Requirements.
- 169502 – This label indicates recognition by a Nationally Recognized Testing Laboratory (NRTL) that the instrument has met the relevant product safety standards.
- CE – This label indicates conformance to various Directives set forth under European Union law.
- Recycling – Refer to the Recycling Label section in this document.

CAUTION Static Sensitive Area



Indicates an area of the instrument which is sensitive to static electrostatic discharge (ESD). To prevent damage due to electrostatic discharge, always wear a properly earth-grounded wrist strap while operating this instrument. For details on proper grounding, see IEEE standard P1100.

DANGER High Voltage



Operation, replacement or servicing of any components where contact with bare, live hazardous parts could occur, possibly resulting in electric shock, should only be performed by your Beckman Coulter representative.

Protective Ground



This symbol is used to indicate a protective ground. This instrument must be properly grounded. Do not under any circumstances operate the instrument unless it is properly grounded.

Alternating Current



This symbol is used to indicate an alternating current (also known as “AC”).

Output Plate Label

Utility Interactive
Output: 200-240 VAC, 50/60 Hz, 8.5A, 0.99pf
Max Output Power: 1.7kW
Max Output Fault Current: 20A
Max Ambient: 35C
This unit or system is provided with fixed trip limits
and shall not be aggregated above 30kW on a single Point of Common Connection.

This is the label that indicates what the output rating are on the instrument.

Rotor Rotation

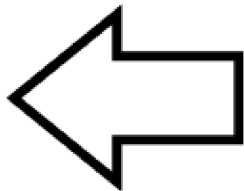

This indicates the direction of instrument rotor rotation.

Symbols

Symbol Symbol Symbole Símbolo	Simbolo 記号 符号	Title / Titel / Titre / Titolo / Titolo / 名称 / 名称
		Dangerous voltage Gefährliche elektrische Spannung Courant haute tension Voltaje peligroso Pericolo: alta tensione 危険電圧 危険电压
		Attention, consult accompanying documents Achtung! Begleitpapiere beachten! Attention, consulter les documents joints Atención, consulte los documentos adjuntos Attenzione: consultare le informazioni allegate 注意、添付資料を参照のこと 注意，请参阅附带的文件
		On (power) Ein (Netzverbindung) Marche (mise sous tension) Encendido Acceso (sotto tensione) 入（電源） 开（电源）
		Off (power) Aus (Netzverbindung) Arrêt (mise hors tension) Apagado Spento (fuori tensione) 切（電源） 关（电源）
		Protective earth (ground) Schutzleiteranschluß Liaison à la terre Puesta a tierra de protección Collegamento di protezione a terra 保護アース（接地） 保护接地
		Earth (ground) Erde Terre Tierra Scarica a terra アース（接地） 接地
		Alternating Current Wechselstrom Courant alternatif Corriente Alterna Corrente Alternata 交流 交流电

Contents



Revision History, iii

Safety and Notices, v

Alerts for Danger, Warning, Caution, Important, and Note, v

Safety Notices, vi

Information, vi

Installation, vi

Replacement Parts, vii

Service, vii

Power Supply, vii

Fuse Replacement, vii

Mechanical Safety, viii

Chemical and Biological Safety, viii

Precautions with Liquids, ix

Volatile Liquids, ix

Certification, ix

Scope of Manual, ix

CFC-Free Centrifugation, x

Software Copyright, x

Biohazard, x

RoHS Notice, xi

China RoHS Caution Label, xi

China RoHS Environmental Label, xi

Summary of Instrument Labels, xii

Caution Symbol, xii

Universal Serial Bus (USB), xii

Ethernet, xii

Biohazard, xii

Recycling Label, xiii

Multiple Compliance, xiii

CAUTION Static Sensitive Area, xiv

DANGER High Voltage, xiv

Protective Ground, xiv

Alternating Current, xiv

Output Plate Label, xv

Rotor Rotation, xv

Symbols, xvi

CHAPTER 1: Description, 1-1

For In Vitro Diagnostic Use, 1-1

Touch Screen, 1-1

Name Rating Plate, 1-1

Rotor Chamber, 1-2

Vacuum System, 1-2

Temperature Sensing and Control, 1-2

Drive, 1-2

Safety Features, 1-3

Door, 1-3

Barrier Ring, 1-3

Imbalance Detector, 1-3

Overspeed System, 1-3

Dynamic Rotor Inertia Check (DRIC), 1-3

Specifications, 1-4

Control Features, 1-4

Physical Data, 1-5

Audible Sounds, 1-8

Available Rotors, 1-8

CHAPTER 2: The Touch Screen Interface, 2-1

Areas on the Screen, 2-1

Header Bar, 2-2

Home Page Button, 2-2

Menu Button, 2-2

Status Display, 2-3

Help Button, 2-4

Footer Bar, 2-4

Start Button, 2-4

Stop Button, 2-4

Footer Bar on the Home Page, 2-5

Footer Bar on Other Pages, 2-5

Vacuum Display/Button, 2-5

System Name, 2-5

Accel and Decel Display/Buttons, 2-6

Page Display Area, 2-6

Help Messages, 2-6

Item Help, 2-6

Global Help, 2-7

CHAPTER 3: Operations, 3-1

Manual Operation, 3-1

Step 1: Start on the Home Page, 3-2

Step 2: Set the Speed and Rotor, 3-3

Step 3: Set the Time, 3-5

Step 4: Set the Temperature, 3-6

Step 5: Start the Run, 3-7

Zonal and Continuous Flow Operation, 3-7

Preparing for the Run, 3-8

Starting the Run, 3-9

Loading the Sample, 3-9

Running the Sample, 3-10

Unloading the Sample, 3-10

Stopping the Run, 3-10

Finishing the Run, 3-10

CHAPTER 4: Functional Pages, 4-1

Home Page, 4-2

w²t Display, 4-2

Set Speed Display/Button, 4-3

Set Time Display/Button, 4-3

Set Temp Display/Button, 4-3

Menu Page, 4-4

Set Speed Page, 4-5

Set Time Page, 4-6

Set Speed Time Page (w²t Mode), 4-7

Set Temperature Page, 4-8

Set Acceleration/Deceleration Profiles Page, 4-9

Example Acceleration and Deceleration Profiles, 4-10

Select Rotor and Labware, 4-11

References Page, 4-12

System Options Page, 4-13

Zonal Authorization Page, 4-14

Continuous Flow Authorization Page, 4-15

Service Login Page, 4-16

About Page, 4-17

Rotor Catalog Page, 4-18

Labware Catalog Page, 4-19

Export User Manual Page, 4-20

Set System Name Page, 4-21

Set Date and Time Page, 4-22
Set Sound Page, 4-23
Select Language Page, 4-24
Diagnostic History Page, 4-25
Compatible Tubes for Rotor Page, 4-26
Zonal Operation Page, 4-27
Continuous Flow Operation Page, 4-28
Running Home Page, 4-29

CHAPTER 5: Maintenance and Troubleshooting, 5-1

Field Service, 5-1
Rotors and Labware, 5-1
Cleaning, 5-1

- Instrument Surfaces, 5-2
- Rotor Chamber, 5-2
- Chamber Door O-ring, 5-2

Decontamination, 5-2
Sterilization and Disinfection, 5-3
Diagnostics/User Messages, 5-3
Retrieving Your Sample in Case of Power Failure, 5-3

- During a Run, 5-3
 - Rotor Spinning at Restoration, 5-3
 - Rotor Stopped at Restoration, 5-4
- Getting Access to the Sample, 5-4
- Restoring the Instrument to Operating Condition, 5-9

Storage and Transportation, 5-10
Supply List, 5-10

- Replacement Parts, 5-10
- Supplies, 5-10

APPENDIX A: Preinstallation Requirements, A-1

Overview, A-1
Space Requirements, A-1

- Safety, A-1
- Ventilation, A-2
- Temperature, A-2

Electrical Requirements, A-3

APPENDIX B: Special Warranty for the Optima XE, B-1

Special Warranty, B-1

APPENDIX C: Diagnostics, C-1

Overview, C-1

Diagnostics/User Messages Chart, C-1

APPENDIX D: Third Party Contributions and Legal Notices, D-1

Illustrations

- 2.1 Home Page, 2-1
- 2.2 Header Bar, 2-2
- 2.3 Home Page Button, 2-2
- 2.4 Menu Button, 2-2
- 2.5 Ready Status, 2-3
- 2.6 Header Bar - Ready Status, 2-3
- 2.7 Header Bar - Running Status, 2-3
- 2.8 Header Bar - Stopping Status, 2-3
- 2.9 Header Bar - Warning Message, 2-3
- 2.10 Header Bar - Fatal Error Message, 2-3
- 2.11 Help Button, 2-4
- 2.12 Start Button, 2-4
- 2.13 Stop Button, 2-4
- 2.14 Footer Bar - Home Page, 2-5
- 2.15 Footer Bar on Other Pages, 2-5
- 2.16 Item Help Button, 2-6
- 2.17 Global Help Button attached to Help Button, 2-7
- 2.18 Home Page Help with ghost image, 2-7
- 2.19 Transparency Button, 2-7
- 2.20 Home Page Help with opaque screen, 2-8
- 2.21 Help Navigation Buttons, 2-8
- 2.22 Zonal/Continuous Flow Operation Help with scroll bar, 2-9
- 3.1 Home Page, 3-2
- 3.2 Zonal Operation Page with Cancel Button, 3-3
- 3.3 Set Speed Page, 3-3
- 3.4 Select Rotor and Labware Page, 3-4
- 3.5 Set Time Page, 3-5
- 3.6 Set Temperature Page, 3-6
- 3.7 Start Button, 3-7
- 3.8 Zonal Page, 3-8
- 3.9 Continuous Flow Page, 3-9
- 4.1 Home Page, 4-2
- 4.2 w²t Display, 4-2

- 4.3 Set Speed Display/Button, 4-3
- 4.4 Set Time Display/Button, 4-3
- 4.5 Set Temp Display/Button, 4-3
- 4.6 Menu Page, 4-4
- 4.7 Set Speed Page (No Rotor Selected), 4-5
- 4.8 Set Speed Page (Rotor Selected), 4-5
- 4.9 Set Time Page, 4-6
- 4.10 Set Speed Time Page (w²t Mode), 4-7
- 4.11 Set Temperature Page, 4-8
- 4.12 Set Acceleration/Deceleration Profiles Page, 4-9
- 4.13 Select Rotor and Labware Page, 4-11
- 4.14 References Page, 4-12
- 4.15 System Options Page, 4-13
- 4.16 Zonal Authorization Page, 4-14
- 4.17 Continuous Flow Authorization Page, 4-15
- 4.18 Service Login Page, 4-16
- 4.19 About Page, 4-17
- 4.20 Rotor Catalog Page, 4-18
- 4.21 Labware Catalog Page, 4-19
- 4.22 Export User Manual Page, 4-20
- 4.23 Set System Name Page, 4-21
- 4.24 Set Date and Time Page, 4-22
- 4.25 Set Sound Page, 4-23
- 4.26 Select Language Page, 4-24
- 4.27 Diagnostic History Page, 4-25
- 4.28 Compatible Tubes for Rotor Page, 4-26
- 4.29 Zonal Operation Page, 4-27
- 4.30 Continuous Flow Operation Page, 4-28
- 4.31 Running Home Page, 4-29
- 5.1 Panel screws and Tabs, 5-5
- 5.2 Internal Parts — Configuration “A” vents through the port cap, 5-6
- 5.3 Internal Parts — Configuration “B” vents through the vacuum solenoid release screw, 5-7
- A.1 Safety and ventilation space, A-2
- A.2 Electrical Connection, A-3

Tables

- A.1 [Required Wire Connections](#), A-4
- C.1 [Diagnostics/User Messages Chart](#), C-1

Description

The Optima XE generates centrifugal forces for the separation of particles. Classified S, it can be used with all currently manufactured Beckman Coulter preparative rotors.

This chapter describes the major components of the instrument.

For *In Vitro* Diagnostic Use

This Optima XE centrifuge is intended for the separation of components through the use of relative centrifugal force.

It is designed to separate human samples, including blood and other body fluids, for processing, analysis, and in vitro diagnostic testing, as well as nonhuman body samples and chemicals, including industrial and environmental samples.

This centrifuge should be operated by qualified personnel only.

Touch Screen

The touch screen is both the information display and the control input for the instrument. As they are needed, control buttons appear on the screen. When you select a button, you activate that control.

The touch screen position is adjustable (both swivel and tilt) to be made viewable from nearly anywhere in the lab. This is especially useful in environments where a single operator may oversee a number of instruments.

Each component of the touch screen interface is explained in the following chapters.

Name Rating Plate

A name rating plate is affixed to the rear of the instrument. Always mention the serial number and model number (available on the [About Page](#)) when contacting Beckman Coulter regarding your instrument.

Rotor Chamber

The rotor chamber is made of aluminum and coated with a chemical-resistant epoxy finish. The central feature is the rotor drive spindle, but several sensors and control systems are also contained in the rotor chamber.

Vacuum System

The Optima XE uses a diffusion pump in series with a mechanical vacuum pump to reduce chamber pressure to a very low level. The system starts automatically when you start a run, or manually when the chamber door is closed and you use the **Vacuum Display/Button** on the Footer Bar of the Home Page. When the vacuum system is on, the chamber pressure is displayed in microns in the **Vacuum Display/Button**.

At the end of a run, press the **Vacuum Display/Button** to vent the chamber vacuum before attempting to open the door. When the chamber vacuum is reduced to the point that you can open the door, the system sounds an audible tone. After you open the door, there is a five minute period where the chamber temperature remains as set (to allow back-to-back runs). Then the chamber returns to approximate room temperature to minimize condensation collecting in the chamber. To help keep the chamber dry and clean, keep the door closed whenever possible. If you wish to vent the chamber before the rotor has come to a complete stop, you can do so as soon as it slows below 3000 rpm.

In zonal or continuous flow operation, the door may remain open while the rotor is spinning up to the loading speed. The vacuum system is activated when the door is closed and the rotor speed is above 3000 rpm (after loading the rotor). Normally, you vent the chamber at the end of the run when the rotor has decelerated to the unloading speed, but you can vent the chamber when the rotor has decelerated below 3000 rpm if the unloading speed is slower than that.

Temperature Sensing and Control

A solid state thermopile in the bottom of the rotor chamber monitors rotor temperature.

The Optima XE uses a solid state thermoelectric refrigeration and heating system without coolant or water. Cooling is provided by forced air from the fans.

When the power is on, the temperature control system starts when the door is closed and the vacuum system is running.

Drive

The frequency-controlled, air-cooled, direct-drive induction motor requires no gears or brushes. In addition, the drive does not require an oil vacuum seal, external oil reservoir, or continuously operating damper. Externally cooled by forced air and internally cooled by oil, the drive delivers ultra-smooth, quiet performance, with high rotor-imbalance tolerance.

Safety Features

The Optima XE ultracentrifuge has been designed and tested to operate safely indoors at altitudes up to 2000 m (6562 ft.).

Door

The high-strength structural steel chamber door has a solenoid interlock to prevent operator contact with a spinning rotor. When the door is closed and a run begins, it locks automatically. It can be opened only when the power is on and the rotor is at rest with the chamber at atmospheric pressure. If there is a power failure, you can manually unlock the door as described in the **Maintenance and Troubleshooting** chapter.

Barrier Ring

A 41-mm (1.63-in.) steel alloy armor ring acts as the primary barrier, surrounded by a 13-mm (0.5-in.) vacuum chamber to provide full protection for the operator.

Imbalance Detector

An imbalance detector monitors the rotor during the run, causing automatic shutdown if rotor loads are severely out of balance. Even at low speeds, an incorrectly loaded rotor can cause an imbalance.

Overspeed System

The overspeed system is a safety feature designed to ensure that the rotor does not exceed its maximum allowable speed. This system includes a photoelectric device in the rotor chamber next to the drive spindle and an overspeed disk on the bottom of the rotor. Individual rotor manuals provide information on the correct overspeed disks to be used with each rotor.

The overspeed disk has alternating light and dark sectors. As the rotor spins, the passage of reflecting and non-reflecting sectors over the photoelectric device generates a series of pulses detected by the electronic circuitry and software.

After the rotor reaches 600 rpm, the set speed is checked against the overspeed disk. If the set speed is greater than the maximum speed permitted by the disk, the speed setting is automatically lowered to the maximum speed of the disk, but the run continues without interruption. An error message appears to alert you to the change.

Dynamic Rotor Inertia Check (DRIC)

As the rotor accelerates between 15000 and 20000 rpm, the instrument checks the rotor inertia and calculates the rotor energy for the speed set by the user. If the calculated rotor energy is excessive, the instrument stops the run with braking to avoid possible damage and sends a diagnostic message to alert you to this condition.

Specifications

Only values with tolerances or limits are guaranteed data. Values without tolerances are informative data, without guarantee.

Control Features

Specifications	Description
Speed	<ul style="list-style-type: none"> • Set speed: <ul style="list-style-type: none"> — 1,000 to rated speed in 100-rpm increments • Maximum speed: <ul style="list-style-type: none"> — XE-90: 90,000 rpm — XE-100: 100,000 rpm • Speed display: <ul style="list-style-type: none"> — Actual measured rotor speed in 10-rpm increments below 1000 rpm and 100-rpm increments ≥ 1000 rpm • Speed control: <ul style="list-style-type: none"> — Actual measured rotor speed, ± 2 rpm at steady state (1,000 rpm to rated speed) • Acceleration: <ul style="list-style-type: none"> — 10 profiles • Deceleration: <ul style="list-style-type: none"> — 11 profiles, including coast • Braking: <ul style="list-style-type: none"> — Regenerative, power reclamation
Time	<ul style="list-style-type: none"> • Set time: <ul style="list-style-type: none"> — Up to 999 hours 59 minutes, including Hold runs — Up to 3.94780×10^{14} radians squared per second in ω^2t mode • Time display: <ul style="list-style-type: none"> — Indicates time remaining in timed runs, time elapsed in Hold runs, or estimated time remaining in ω^2t runs • Time accuracy: <ul style="list-style-type: none"> — ± 70 ppm (6 seconds/day) • Run modes: <ul style="list-style-type: none"> — Time, ω^2t, and RCF

Specifications	Description
Temperature	<ul style="list-style-type: none"> • Set temperature: <ul style="list-style-type: none"> — 0 to 40°C in 1°C increments • Rotor Temperature (after equilibration): <ul style="list-style-type: none"> — $\pm 0.5^{\circ}\text{C}$ over entire set temperature range for all rotors except SW-32 — $\pm 0.8^{\circ}\text{C}$ over entire set temperature range for SW-32 • Temperature display: <ul style="list-style-type: none"> — Actual rotor temperature in 0.1°C increments • Ambient temperature range: <ul style="list-style-type: none"> — 10 to 35°C • Humidity restrictions: <ul style="list-style-type: none"> — <80% at <35°C (non-condensing) • Condensation removal: <ul style="list-style-type: none"> — Automatic (begins five minutes after vacuum vent) • Vacuum: <ul style="list-style-type: none"> — Below 5 microns (0.7 Pa)
Ease of Use	<ul style="list-style-type: none"> • Languages: <ul style="list-style-type: none"> — Multi-language support • Help: <ul style="list-style-type: none"> — On-screen, context sensitive • Diagnostic messages: <ul style="list-style-type: none"> — 10,000 messages saved

Physical Data

Specification	Description
Dimensions	<ul style="list-style-type: none"> • Width : <ul style="list-style-type: none"> — 94.0 cm (37 in.) • Depth: <ul style="list-style-type: none"> — 68.1 cm (26.8 in.) • Height: <ul style="list-style-type: none"> — 125.7 cm (49.5 in.) • Weight <ul style="list-style-type: none"> — 485 kg (1068 lb)
Ventilation Clearances	<ul style="list-style-type: none"> • Sides <ul style="list-style-type: none"> — 5.1 cm (2.0 in.) • Rear <ul style="list-style-type: none"> — 15.2 cm (6.0 in.)

Specification	Description
Finishes	<ul style="list-style-type: none"> • Rotor pad: <ul style="list-style-type: none"> — Coated polycarbonate • Top and Front surfaces: <ul style="list-style-type: none"> — Polyurethane • Other surfaces: <ul style="list-style-type: none"> — Acrylic baking enamel
Electrical	<ul style="list-style-type: none"> • Power requirement: <ul style="list-style-type: none"> — 200–240 VAC, 30A branch circuit, 50/60 Hz — Automatic tap selection on every run • Electrical supply: <ul style="list-style-type: none"> — Class I • Power Consumption: <ul style="list-style-type: none"> — 60W in idle — 1.0 kW average running in steady state at 90K rpm • Installation (overvoltage) category: <ul style="list-style-type: none"> — II • LCD Monitor: <ul style="list-style-type: none"> — Wide tilt range, horizontal and vertical
Outputs	<ul style="list-style-type: none"> • Power Factor: <ul style="list-style-type: none"> — 0.99 • Nominal Output Voltage: <ul style="list-style-type: none"> — 200/240 • Output Frequency: <ul style="list-style-type: none"> — 50/60 Hz • Max Output Current: <ul style="list-style-type: none"> — 8.5A • Max Fault Current: <ul style="list-style-type: none"> — 20A

Specification	Description
Environmental	<ul style="list-style-type: none">• RoHS compliant material:<ul style="list-style-type: none">— 100% of content• Cooling system:<ul style="list-style-type: none">— Thermoelectric (no CFC gases used)• Noise output (1m in front of instrument):<ul style="list-style-type: none">— <51 dBA (Sound pressure level)— 7.0 sones (Zwicker Loudness)• Maximum heat dissipation into room under steady-state conditions:<ul style="list-style-type: none">— 3400 Btu/hr (1.0 kW)• Pollution degree:<ul style="list-style-type: none">— 2^a• HEPA filter:<ul style="list-style-type: none">— Available

- a. Normally, only non-conductive pollution occurs; occasionally, however, a temporary conductivity caused by condensation must be expected.

Audible Sounds

The Optima XE instrument will make an audible sound while displaying a corresponding visual prompt with the following events:

- Boot up
- Start of Run
- End of Run
- Diagnostics/Alert
- Vacuum low enough to open door
- Door open during Zonal or Continuous Flow mode

Available Rotors

All currently manufactured Beckman Coulter floor model ultracentrifuge rotors can be used in the Optima XE ultracentrifuge. The rotors are described in individual manuals that accompany each rotor. Information on rotors and accessories is available in the Rotor Catalog accessible from the touch screen. Additional information is available in *Rotors and Tubes for Preparative Ultracentrifuges* (LR-IM) and in the Beckman Coulter *Ultracentrifuge Rotors, Tubes & Accessories* catalog (publication BR-8101). The Beckman Coulter website, <http://www.beckmancoulter.com>, contains additional information about centrifugation processes and products.

Refer to specific rotor manuals for proper installation and removal of rotors from the instrument.

The Touch Screen Interface

This chapter describes the touch screen interface for the Optima XE. Except for the power switch, all the controls for the instrument are programmed controls that appear on the touch screen.

Figure 2.1 Home Page



Areas on the Screen

The items on the screen may change, depending on the state of the instrument. There are three areas where items appear on the screen:

- The Header Bar
- The Footer Bar
- The Page Display Area

Header Bar

Figure 2.2 Header Bar



The area across the top of the screen is called the Header Bar, containing four important items:

- **Home** Page Button
- **Menu** Button
- **Status** Display
- **Help** Button

The following sections explain these items.

Home Page Button

Figure 2.3 Home Page Button



The **Home Page** Button takes you to the [Home Page](#) from any other page. When you use Zonal Mode or Continuous Flow Mode, the **Zonal/Continuous Flow Operation** Page replaces the **Home** Page.

Menu Button

Figure 2.4 Menu Button



The **Menu** Button presents a list of menu items, allowing you to choose a particular function:

- Options
- References
- About
- Zonal Operation
- Continuous Flow Operation
- Service Mode

The menu options are explained in the following chapter.

Status Display

Figure 2.5 Ready Status



The Status Display is in the middle of the Header Bar and shows you the current instrument status. The background color of the header bar changes with the type of status:

- Blue background: system ready (no run in progress).

Figure 2.6 Header Bar - Ready Status



- Green background: in operation (run in progress).

Figure 2.7 Header Bar - Running Status



- Green background: in operation (stop in progress).

Figure 2.8 Header Bar - Stopping Status



- Yellow background: warning message.

Figure 2.9 Header Bar - Warning Message



- Red background: fatal error message.

Figure 2.10 Header Bar - Fatal Error Message



Help Button

Figure 2.11 Help Button



The **Help** button gives you access to the built-in online help messages. Help messages are described at the end of this chapter.

Footer Bar

The bottom of the touch screen always shows the footer bar. The footer bar appears in two different ways, but it always has the **Start** Button at the left and the **Stop** Button at the right.

Start Button

Figure 2.12 Start Button



The **Start** Button begins a run with the current settings. Use it only after you have set the parameters for the run.

Stop Button

Figure 2.13 Stop Button



The **Stop** button stops the current run immediately. This is ordinarily only used for emergencies or if you mistakenly set too long a run time.

Footer Bar on the Home Page

On the **Home** Page, the middle of the Footer Bar shows three Items:

- The **Vacuum** Display/Button
- The System Name
- The **Accel** Display/**Decel** Display/Button

Figure 2.14 Footer Bar - Home Page

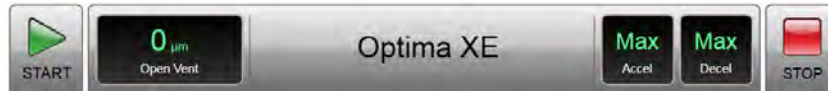

Each of these is explained below.

Footer Bar on Other Pages

When not on the Home Page, the three buttons for Speed, Time and Temperature appear in the Footer Bar for easy access. To set Acceleration or Deceleration profiles, or to use the **Vacuum** button, simply press **Home** button to return to the **Home** Page. The following items are described in detail within the **Home** Page section of the next chapter:

- The **Set Speed** Display/Button
- The **Set Time** Display/Button
- The **Set Temp** Display/Button

Figure 2.15 Footer Bar on Other Pages



Vacuum Display/Button

As a display, the Vacuum Display/Button shows the current chamber vacuum and the action that will be performed when the button is pressed. As a control, it serves two functions:

- Before a run, after mounting the rotor and closing the chamber door, press this control to evacuate the chamber and precondition the chamber to the set temperature.
- After a run, press this control to release the vacuum before opening the chamber door.

System Name

The system name is simply a display. You can set the system name as one of the options on the [System Options Page](#).

Accel and Decel Display/Buttons

These are two displays that, together, act as a single button.

As a display, each shows the selected acceleration or deceleration profile currently selected. If you select either one of them, it takes you to the [Set Acceleration/Deceleration Profiles Page](#), described in the next chapter.

Page Display Area

The Page Display Area is the main display area between the Header Bar and the Footer Bar. The pages and help messages all appear in this area. The pages are all described in [CHAPTER 4](#).

Help Messages

When you first select the **Help** Button, a number of new buttons appear on the screen, giving you three sets of options:

- Item Help
- Global Help
- Exit from Help.

Item Help

Item Help Buttons appear on-screen items where you can get an item help message. These are brief pop-up messages describing what the item does. Only one help message remains on the screen at a time.

Figure 2.16 Item Help Button



Global Help

The **Global Help** Button appears next to the **Help** Button. If you select the **Global Help** Button, the Page Display Area shows you a description of the current page and all the elements it contains.

Figure 2.17 Global Help Button attached to Help Button

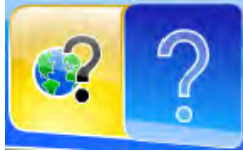

While using Global Help, you also have some additional options:

- The **Global Help** page appears over a ghost image of the screen you were on when you selected global help.

Figure 2.18 Home Page Help with ghost image



If the ghost image makes it difficult for you to read the **Help** Page, select the **Transparency** Button in the upper right corner.

Figure 2.19 Transparency Button



The resulting opaque help page eliminates the image of the screen behind it.

Figure 2.20 Home Page Help with opaque screen

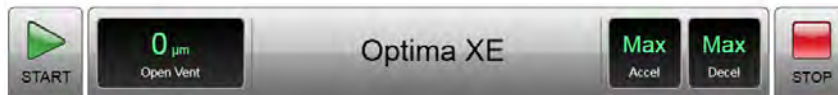
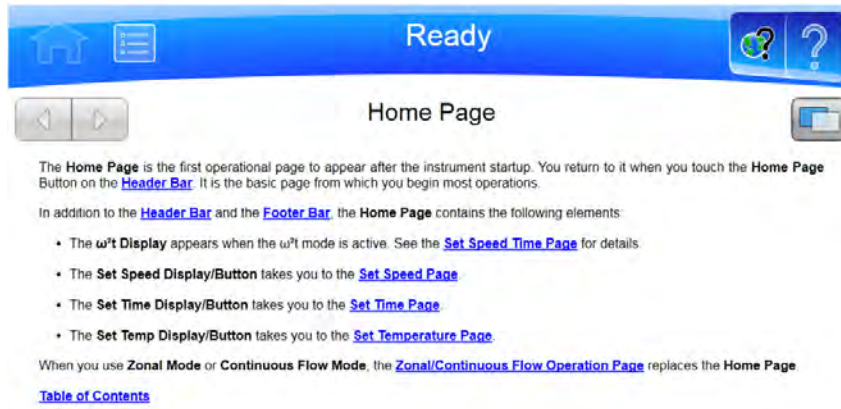

Select the **Transparency** Button again to return to the ghost screen image.

- If you need information about some other aspect of the instrument, you can select the Table of Contents link at the bottom of the page to see the outline of all the available help pages. You have access to all of the help pages from the Table of Contents.

Figure 2.21 Help Navigation Buttons



- To navigate through your selected help pages, use the **Forward** and **Back** buttons in the upper left corner.

- If the global help page is too large to fit in the page display area, a Scroll Bar appears on the right side, allowing you to scroll up and down through the page.

Figure 2.22 Zonal/Continuous Flow Operation Help with scroll bar

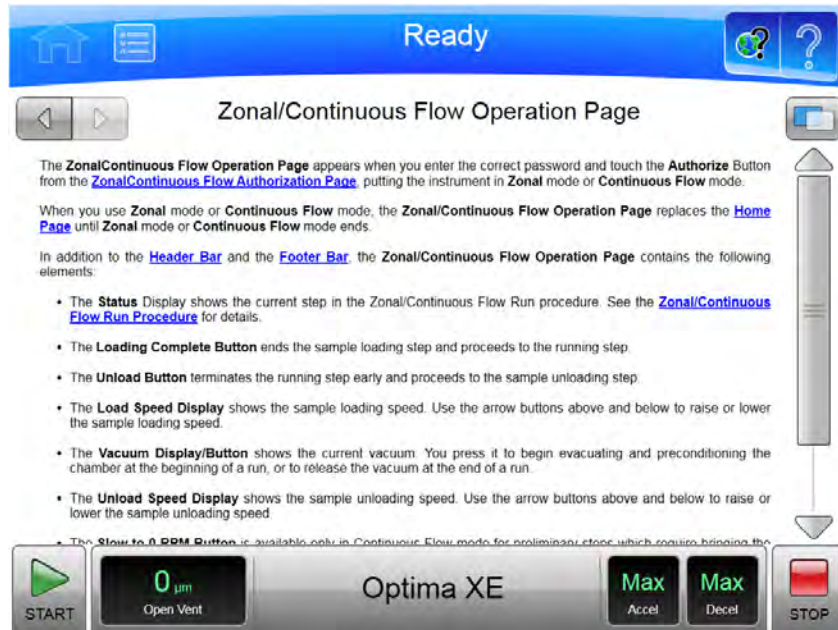

Operations

The touch screen interface for the Optima XE makes operations about as simple as possible. Although there are many additional things you can do, this chapter outlines basic operations:

- Manual Operation
- Operations with Preconditioning
- Continuous Flow Operation
- Zonal Operation

Manual Operation

Manual operation is a simple procedure you can do from the **Home** Page.

Before you begin, there are four things you must know:

- What kind of rotor you are using for the run.
- What speed you want for the run.
- How long the run should be.
- What temperature you want for the run.

When you have this information, the procedure for the run is as follows:

1 Start on the **Home** Page.

2 Set the speed and rotor.

3 Set the time.

4 Set the temperature.

5 Start the run.

Step 1: Start on the Home Page

Start at the **Home** Page. If your screen shows any other page, press the **Home Page** Button in the upper left corner of the screen.

Figure 3.1 Home Page



NOTE If your system is in Zonal Mode or Continuous Flow Mode, you have to press the **Cancel** Button to go to the Home Page.

Figure 3.2 Zonal Operation Page with Cancel Button

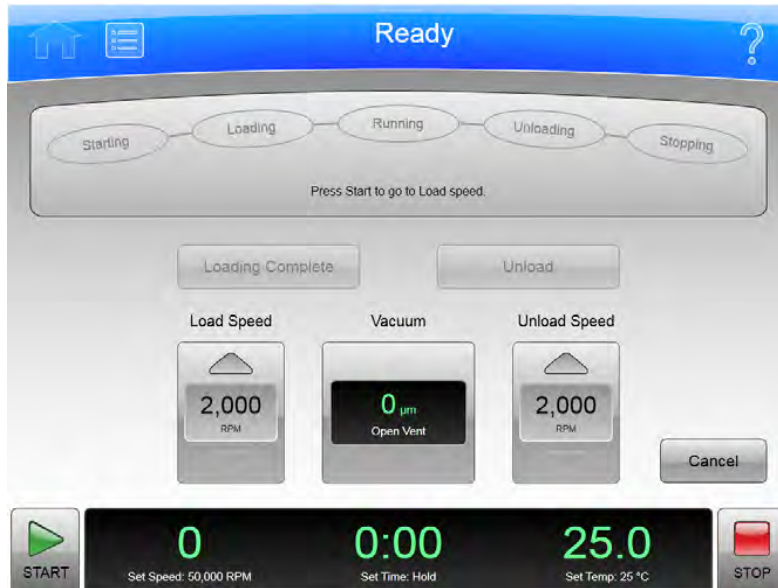

Step 2: Set the Speed and Rotor

Press the **Set Speed Display/Button** on the **Home Page** to go to the **Set Speed Page**.

Figure 3.3 Set Speed Page

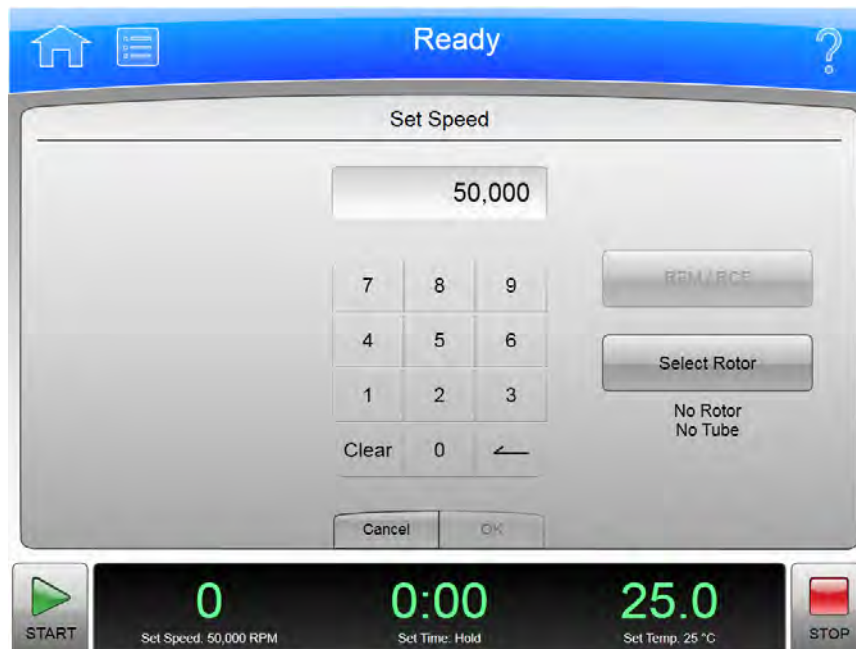

When the **Set Speed** Page appears, follow these steps:

- 1 Press the **Select Rotor** Button to go to the **Select Rotor and Labware** Page.

Figure 3.4 Select Rotor and Labware Page

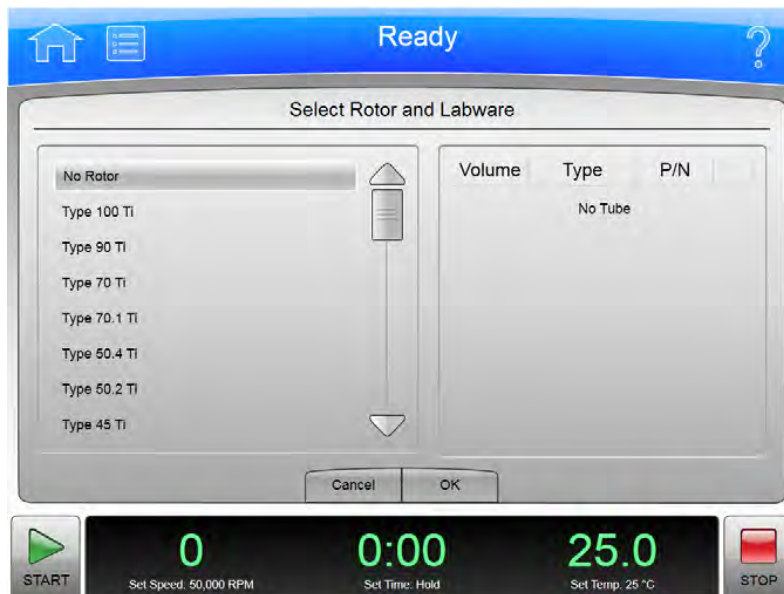

- 2 Select the rotor and labware for the run from the list.
- 3 Select the **OK** Button to return to the **Set Speed** Page.
- 4 If you plan to set the speed in units of relative centrifugal field (RCF), select the **RPM/RCF** Button. Note that the RPM/RCF button is only enabled when you have selected a rotor.
- 5 Use the keypad to set the desired speed. Note that you actually enter hundreds, with two ending zeroes added to your number. You can also use the **Backspace** and **Clear** keys to make corrections.
- 6 Select the **OK** key to accept your entry and dismiss the page.

Step 3: Set the Time

Press the **Set Time** Display/Button to go to the **Set Time** Page.

Figure 3.5 Set Time Page



On the **Set Time** Page, follow two steps:

- 1 Use the keypad to set the desired time in hours and minutes. Use the **Backspace** and **Clear** keys to make corrections. You can also use the **Hold** key to set the time to a hold state with no countdown to an automatic end. When you use a **Hold** value, the run does not end until you select the **Stop** key (or until the maximum time of 999 hours and 59 minutes has been reached).
- 2 Select the **OK** key to accept your entry and dismiss the page.

Step 4: Set the Temperature

Press the **Set Temp Display/Button** to go to the **Set Temperature Page**.

Figure 3.6 Set Temperature Page



On the **Set Temperature Page**, follow two steps:

- 1 Use the keypad to set the desired temperature in degrees Celsius. Use the **Backspace** and **Clear** keys to make corrections.
- 2 Select the **OK** key to accept your entry and dismiss the page.

Step 5: Start the Run

Once the run values are set, start the run:

- 1 Prepare your samples and place them in the rotor following all proper procedures, including balanced weight distribution.
- 2 Preheat or precool the rotor and samples, if necessary.
- 3 Mount the rotor in the instrument following all the procedures in the rotor manual and observing all safety procedures and cautions.
- 4 Close and lock the chamber door. For preconditioning, press the Vacuum Display/Button and wait until the chamber reaches the set temperature.
- 5 Press the **Start** button.

Figure 3.7 Start Button



When the run begins, wait for the countdown timer to reach zero and the rotor to come to a stop. You can then remove your rotor and samples.

Zonal and Continuous Flow Operation

WARNING

In zonal and continuous flow operation, the operator is unavoidably exposed to rotating machinery. For safety, the operator must be properly instructed and qualified. Guard against accidentally dropping objects, such as pens, pencils, or hemostats into the chamber. Loose lab coats, neckties, scarves, and long necklaces should not be worn while operating in the zonal or continuous flow mode.

Use only zonal rotors in the zonal mode.

Use only continuous flow rotors in the continuous flow mode.

Zonal and continuous flow operations require special rotors and have some additional hazards in that samples are loaded and unloaded while the rotor is spinning. To prevent unauthorized users from attempting these operations, the instrument requires a password (which is 1793). When zonal

or continuous flow operations have been authorized, the **Zonal Operation** Page or the **Continuous Flow Operation** Page replaces the **Home** Page. The mode does not end until the run is complete or the user selects the **Cancel** Button to end the mode.

Zonal and Continuous Flow operations are very similar. The specific details vary according to the rotor you are using, but the summary below shows an outline of the procedure.

Figure 3.8 Zonal Page

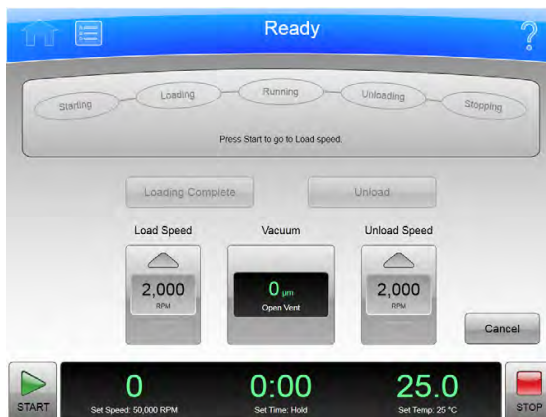

There are seven phases to a Zonal or Continuous Flow run:

- Preparing
- Starting
- Loading
- Running
- Unloading
- Stopping
- Finishing

Each phase is outlined in a section below.

Preparing for the Run

The rotor manual details the preparations for a run, which may include cleaning, assembling, and lubricating the rotor, setting up pumps and tubing, and usually includes overnight cooling to precondition the rotor, sample and solutions used in the run. When you are ready to install the rotor, set the parameters for the run:

- Run Speed
- Run Time
- Temperature
- Load Speed
- Unload Speed

For Continuous Flow operation, you may have two different load speed settings. The initial setting is for alignment and adjustment checks, which you set in this phase.

When everything else is ready, mount the rotor and select the **Vacuum** Display/Button to begin preconditioning the chamber. When the chamber reaches the set temperature, you are ready to start the run.

Starting the Run

To start the run, press the **Start** Button and wait for the rotor to reach loading speed. The status display at the top of the screen highlights Starting.

For a Continuous Flow run, you need to perform alignment and adjustment checks as detailed in the rotor manual. You may need to use the **Slow to Zero RPM** button to make adjustments and restart with the **Start** Button. Refer to Figure 4-9. When the rotor passes the alignment and adjustment checks, set the new loading speed (if it is different from the adjustment speed) and press the **Start** Button again.

Figure 3.9 Continuous Flow Page

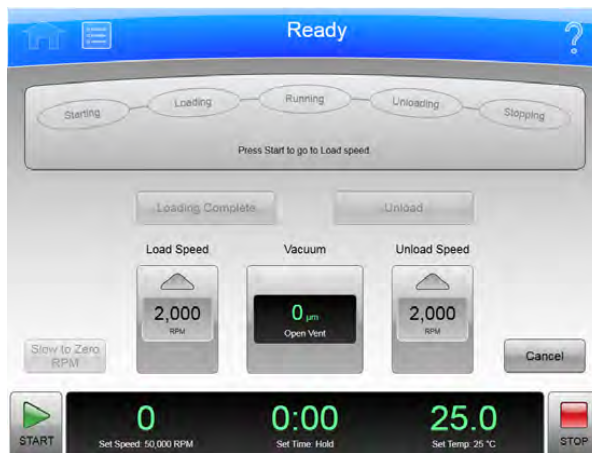

When the rotor reaches the Loading speed, the status display highlights Loading, to show that you have moved into the next phase.

Loading the Sample

In the Loading phase, you inject the sample into the medium in the rotor. Again, the details depend on the rotor and the type of operation as detailed in the rotor manual. When you have finished all the specified loading steps, close the door, and select the **Loading Complete** button to go to the next phase.

Running the Sample

The instrument highlights Running on the Status Display, accelerates to the set run speed, and begins counting down the set run time. The run phase ends in one of three ways:

- When the timer countdown reaches zero, the instrument decelerates to the unloading speed and goes to the Unloading phase.
- If you select the **Unload** Button to terminate the run early, the instrument decelerates to the unloading speed and goes to the Unloading phase.
- If you select the **Stop** Button to abort the run, the instrument brings the rotor to a halt, skips the unloading phase, and exits Zonal or Continuous Flow mode entirely.

Unloading the Sample

While the rotor is running at unload speed, follow the instructions in the rotor manual to inject the displacement solution into the rotor and collect the resulting centrifugate sample.

Stopping the Run

When you have completed all the defined unloading steps, press the **Stop** Button to bring the rotor to a halt.

Finishing the Run

When the rotor comes to a halt, unmount it and perform all the cleanup and follow-up steps given in the rotor manual. The instrument exits Zonal or Continuous Flow mode when the rotor comes to a stop.

Functional Pages

This chapter describes the functional pages that you use to control the Optima XE Ultracentrifuge. They include all of the following:

- [Home Page](#)
- [Menu Page](#)
- [Set Speed Page](#)
- [Set Time Page](#)
- [Set Speed Time Page \(w²t Mode\)](#)
- [Set Temperature Page](#)
- [Set Acceleration/Deceleration Profiles Page](#)
- [Select Rotor and Labware](#)
- [References Page](#)
- [System Options Page](#)
- [Zonal Authorization Page](#)
- [Continuous Flow Authorization Page](#)
- [Service Login Page](#)
- [About Page](#)
- [Rotor Catalog Page](#)
- [Labware Catalog Page](#)
- [Export User Manual Page](#)
- [Set System Name Page](#)
- [Set Date and Time Page](#)
- [Set Sound Page](#)
- [Select Language Page](#)
- [Diagnostic History Page](#)
- [Compatible Tubes for Rotor Page](#)
- [Zonal Operation Page/Continuous Flow Operation Page](#)
- [Running Home Page](#)

Home Page

The **Home** Page is the first operational page to appear after the instrument startup. You return to it when you select the **Home** Page Button on the Header Bar. It is the basic page from which you begin most operations.

In addition to the Header Bar and the Footer Bar, the **Home** Page contains the following elements:

- The ω^2t Display.
- The **Set Speed** Display/Button.
- The **Set Time** Display/Button.
- The **Set Temp** Display/Button.

When you use Zonal Mode or Continuous Flow Mode, the **Zonal/Continuous Flow Operation** Page replaces the **Home** Page.

Figure 4.1 Home Page



ω^2t Display

Figure 4.2 ω^2t Display

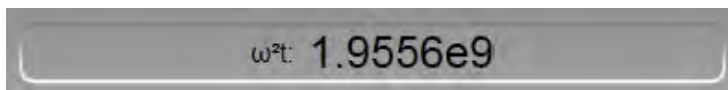

The ω^2t Display appears only when you have set the ω^2t mode on the [System Options Page](#). It shows the accumulated ω^2t value for the run in progress. See the **Set Speed Time** Page for details.

Set Speed Display/Button

Figure 4.3 Set Speed Display/Button



The **Set Speed** Display/Button shows the current rotor speed as a large number and also shows the current run speed setting in small characters across the bottom.

The **Set Speed** Display/Button takes you to the [Set Speed Page](#) (or to the [Set Speed Time Page \(w²t Mode\)](#) if the ω^2t mode is active)

When you are not on the **Home** page, the **Set Speed** Display/Button appears in the Footer Bar.

Set Time Display/Button

Figure 4.4 Set Time Display/Button



The **Set Time** Display/Button shows the current remaining run time as a large number and also shows the current run duration setting in small characters across the bottom. Before you begin a run, the numbers are the same. During a run, the large number counts down to zero.

When you select the **Set Time** Display/Button, it takes you to the [Set Time Page \(Set Speed Time Page \(w²t Mode\)](#) if the ω^2t mode is active).

When you are not on the **Home** page, the **Set Time** Display/Button appears in the Footer Bar.

Set Temp Display/Button

Figure 4.5 Set Temp Display/Button



The **Set Temp** Display/Button shows the current rotor temperature as a large number, and also shows the current temperature setting in small characters across the bottom.

When you select the **Set Temp** Display/Button, it takes you to the [Set Temperature Page](#).

When you are not on the **Home** page, the **Set Temp** Display/Button appears in the Footer Bar.

Menu Page

Figure 4.6 Menu Page



The **Menu** Page appears when you select the **Menu** Button in the Header Bar, allowing you access to the menu choices. Choosing an option dismisses the **Menu** page and goes to the selected page.

- The **Options** Button takes you to the [System Options Page](#).
- The **References** Button takes you to the [References Page](#).
- The **About** Button takes you to the [About Page](#).
- The **Zonal Operation** Button takes you to the [Zonal Operation Page](#).
- The **Continuous Flow Operation** Button takes you to the [Continuous Flow Authorization Page](#).
- The **Service Mode** Button is used by service personnel only. If you accidentally select this button and go to the **Service Login** Page, select the **Cancel** button to dismiss the page.

Each of these pages is described in a following section.

There is also a **Done** button at the bottom of the page that dismisses the page.

Set Speed Page

Figure 4.7 Set Speed Page (No Rotor Selected)

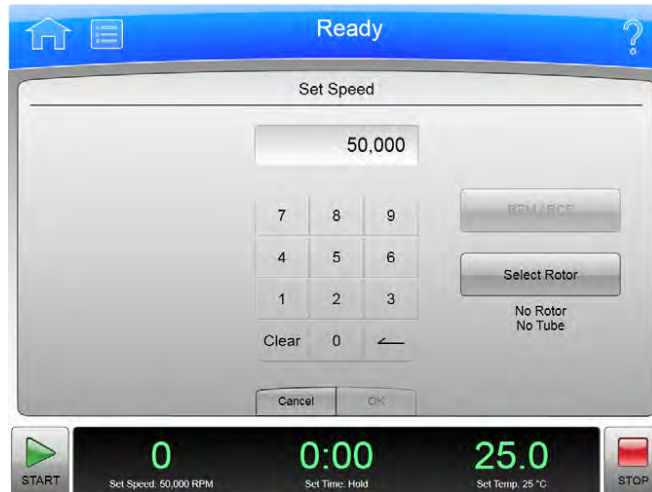

Figure 4.8 Set Speed Page (Rotor Selected)



The **Set Speed** Page appears when you select the **Set Speed** Display/Button on the **Home** Page or the Footer Bar, allowing you to set the speed for the next run. As an alternate, if you have already selected a rotor, you can set the units in RCF (Relative Centrifugal Field) instead of RPM.

If the instrument is in ω^2t mode, the **Set Speed Time** Page appears instead.

In addition to the Header Bar and the Footer Bar, the **Set Speed** Page contains the following elements:

- The Set Speed Display at the top of the page shows the current Set Speed in RPM or RCF. The last two digits are always zeroes when the speed is above 1000 RPM.
- The Keypad changes the speed setting. You can use the Clear and Backspace keys to make corrections.

- The **RPM/RCF** Button selects the type of speed units. This button is disabled until a rotor is selected.
- The **Select Rotor** Button takes you to the [Select Rotor and Labware](#) Page.
- The **Cancel** Button discards your changes and dismisses the page.
- The **OK** Button accepts your changes and dismisses the page.

Set Time Page

Figure 4.9 Set Time Page

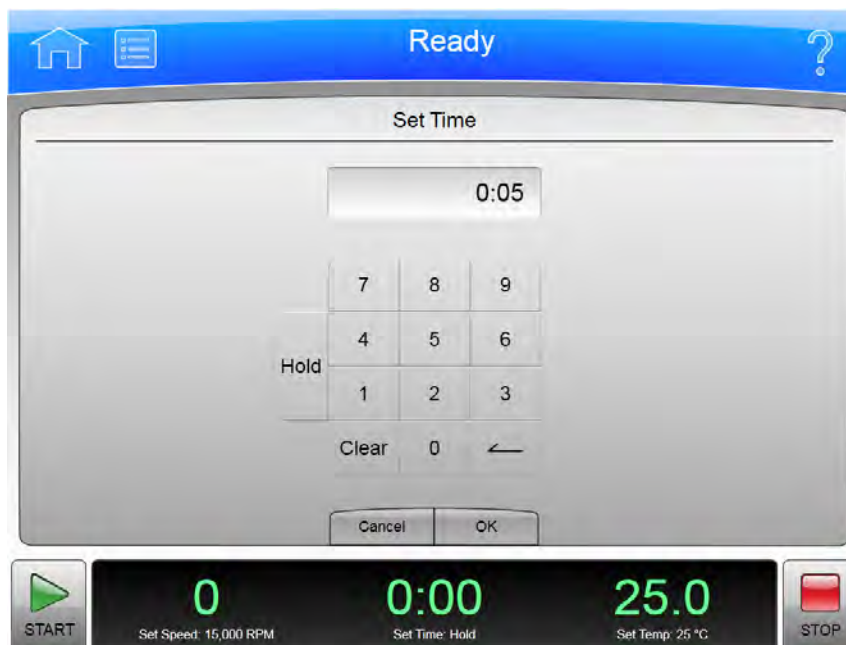

The **Set Time** Page appears when you select the **Set Time** Display/Button on the **Home** Page or the Footer Bar, allowing you to set the duration for the next run.

If the instrument is in ω^2t mode, the **Set Speed Time** Page appears instead.

In addition to the Header Bar and the Footer Bar, the **Set Time** Page contains the following elements:

- The Set Time Display shows the current **Set Time** setting in hours and minutes.
- The Keypad changes the time setting. You can use the Clear and Backspace keys to make corrections.
- The **Cancel** Button discards your changes and dismisses the page without changing the current values.
- The **OK** Button accepts your changes and dismisses the page.

Set Speed Time Page (ω^2t Mode)

Figure 4.10 Set Speed Time Page (ω^2t Mode)



The **Set Speed Time** Page appears when the ω^2t mode is active and you select either the **Set Speed** Button or the **Set Time** Button on the **Home** Page or the Footer Bar. The ω^2t value is computed from the time and RPM (or RCF) values you enter. Having these all on the same page allows you to set the values for the next run that produce the desired ω^2t value.

Turn the ω^2t mode on and off with the ω^2t **Mode** Button on the [System Options Page](#).

In addition to the Header Bar and the Footer Bar, the **Set Speed Time** Page contains the following elements:

- The **Set Speed** Button/Display shows the current Speed in RPM or RCF. When you touch it, the keyboard becomes active to set a new speed value. The ω^2t value changes to reflect the new speed value.
- The ω^2t Button/Display shows the current ω^2t value. When you touch it, the keyboard becomes active to set a new ω^2t value. The time value changes to reflect the new ω^2t value.
- The **Set Time** Button/Display shows the current time setting in hours and minutes. When you touch it, the keyboard becomes active to set a new time value. The ω^2t value changes to reflect the new time value.
- The **RPM/RCF** Button selects the type of speed units. You must have a rotor selected to use RCF.
- The **Select Rotor** Button takes you to the [Select Rotor and Labware](#) Page.
- The Keypad changes slightly depending on the value you are entering. For setting time, use the Hold key to set a hold value. For setting ω^2t , use the decimal and e keys to enter values in exponential notation.
- The **Cancel** Button discards your changes and dismisses the page.
- The **OK** Button accepts your changes and dismisses the page.

Set Temperature Page

Figure 4.11 Set Temperature Page



The **Set Temperature** Page appears when you select the **Set Temperature** Button on the **Home** Page or the Footer Bar, allowing you to set the temperature for the next run.

In addition to the Header Bar and the Footer Bar, the **Set Temperature** Page contains the following elements:

- The Set Temperature Display shows the current **Set Temperature** setting in degrees Celsius.
- The Keypad changes the temperature setting.
- The **Cancel** Button discards your changes and dismisses the page.
- The **OK** Button accepts your changes and dismisses the page.

To precondition the chamber to the selected temperature, use the **Vacuum** Button/Display on the Footer Bar of the **Home** Page.

Set Acceleration/Deceleration Profiles Page

Figure 4.12 Set Acceleration/Deceleration Profiles Page



The **Set Acceleration/Deceleration Profiles** Page appears when you select the **Accel/Decel** Button/Display in the Footer Bar, allowing you to choose profiles for acceleration and deceleration.

In addition to the Header Bar and the Footer Bar, the **Set Acceleration/Deceleration Profiles** Page contains the following elements:

- Acceleration lets you to choose an acceleration value by selecting a number.
- Deceleration lets you choose a deceleration value by selecting a number.
- The **Cancel** Button discards your changes and dismisses the page.
- The **OK** Button accepts your changes and dismisses the page.

The acceleration values are the degree of reduction from the maximum value. The acceleration value of zero is the maximum (no reduction). The acceleration value of 9 is the slowest (maximum reduction). The same applies to the deceleration values. The value 10 is an absolute reduction, eliminating all braking and allowing the rotor to coast to a stop.

Slower (numerically higher) acceleration and deceleration values minimize sample-to-gradient interface disturbance. Each acceleration profile has a designated time that it takes to reach a specified speed. After that, it uses maximum acceleration to reach run speed. For a deceleration profile, the instrument uses maximum deceleration until it reaches the specified speed, then takes the designated time to slow to a stop.

Example Acceleration and Deceleration Profiles

The values associated with each acceleration and deceleration profile are given in the tables below.

NOTE The values shown should be considered as approximations for time and rpm.

Acceleration			Deceleration		
Profile #	Time	RPM	Profile #	Time	RPM
0 (Max)	0:00	0	0 (Max)	0:00	0
1	2:00	170	1	2:00	170
2	2:40	350	2	2:40	350
3	3:00	500	3	3:00	500
4	3:00	170	4	3:00	170
5	4:00	350	5	4:00	350
6	4:30	500	6	4:30	500
7	4:00	170	7	4:00	170
8	5:20	350	8	5:20	350
9	6:00	500	9	6:00	500
			10	Coast	

For example, at an acceleration profile value of 5, the instrument takes four minutes to accelerate to 350 rpm, then proceeds to the run speed at maximum acceleration. For a deceleration profile of 3, the instrument uses maximum deceleration until it reaches 500 rpm, then takes three minutes to slow to a stop.

The exception is a deceleration profile of 10, for which no braking is applied at all. This is generally not used for high-speed runs because of the extremely long length of time it would take for the rotor to come to a stop.

Select Rotor and Labware

Figure 4.13 Select Rotor and Labware Page

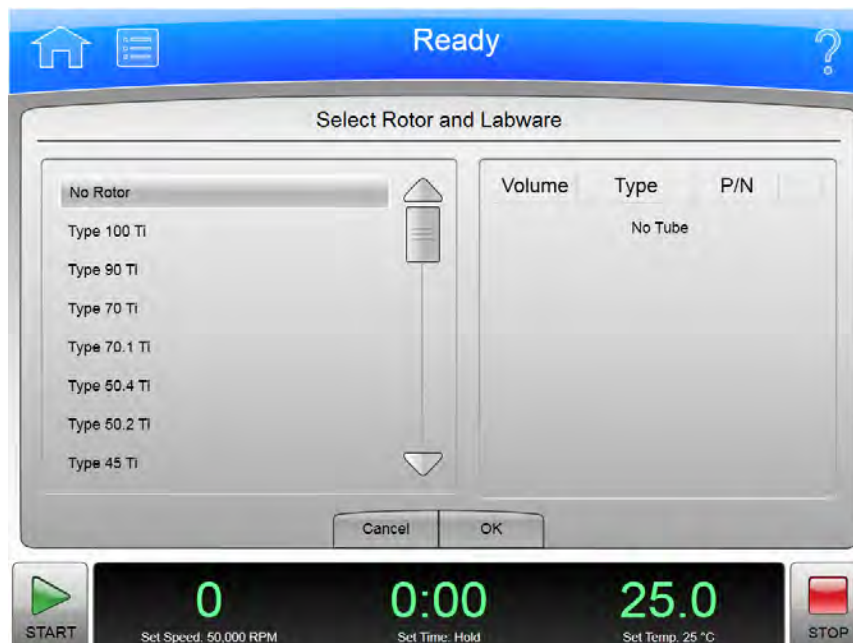

The **Select Rotor and Labware** Page appears when you select the Button on either the **Set Speed** Page or the **Set Speed Time** Page, allowing you to select a rotor for the next run.

This is different from the **Rotor Catalog** Page, which shows rotor specifications, but does not select one for your next run.

In addition to the Header Bar and the Footer Bar, the **Select Rotor and Labware** Page contains the following elements:

- The Rotor Catalog List shows the available rotors for the instrument. You can select a rotor from this list. If the No Rotor value is selected, you cannot use RCF units on the **Set Speed** Page.
- The **Cancel** Button dismisses the page and any changes.
- The **OK** Button accepts the selection and dismisses the page.

For details about each rotor or labware, use the **Rotor Catalog** Page. This page only lists names for selection.

References Page

Figure 4.14 References Page

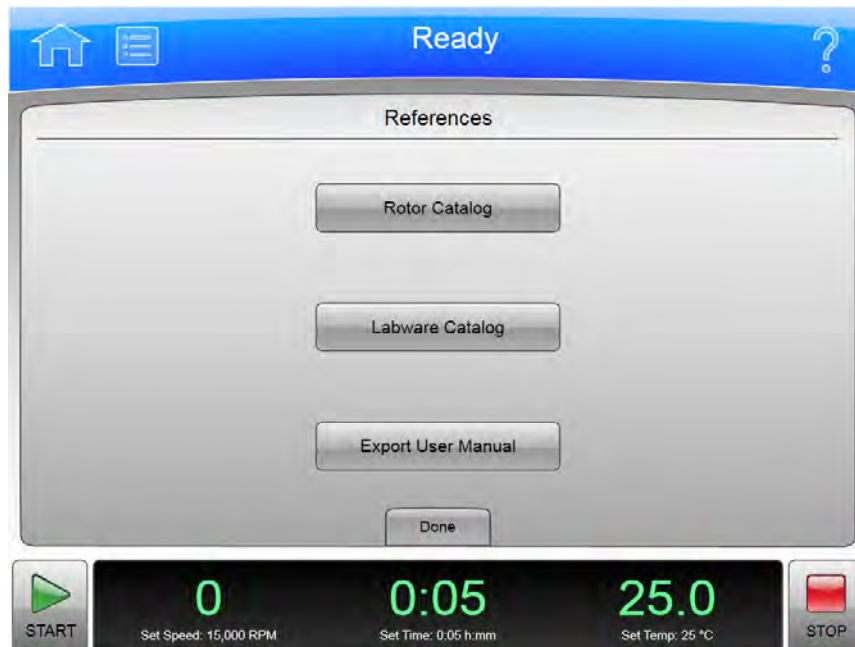

The **References** Page appears when you select the **References** Button in the **Menu** Page, allowing you to choose from the available reference materials to view.

In addition to the Header Bar and the Footer Bar, the **References** Page contains the following elements:

- The **Rotor Catalog** button takes you to the [Rotor Catalog Page](#).
- The **Labware Catalog** button takes you to the [Labware Catalog Page](#).
- The **Export User Manual** button takes you to the [Export User Manual Page](#).
- The **Done** Button dismisses the page.

System Options Page

Figure 4.15 System Options Page

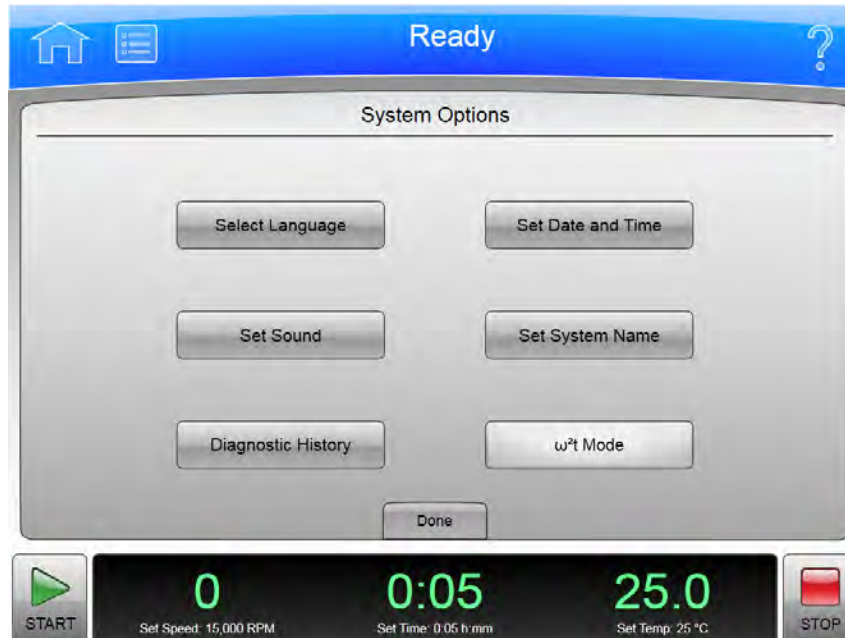

The **System Options** Page appears when you select the **Options** Button in the **Menu** Page, allowing you to choose any of the available system option setting pages.

In addition to the Header Bar and the Footer Bar, the **System Options** Page contains the following elements:

- The **Select Language** Button takes you to the [Select Language Page](#).
- The **Set Sound** Button takes you to the [Set Sound Page](#).
- The **Diagnostic History** Button takes you to the [Diagnostic History Page](#).
- The **Set Date and Time** button takes you to the [Set Date and Time Page](#).
- The **Set System Name** Button takes you to the [Set System Name Page](#).
- The **ω²t Mode** Button toggles the ω²t mode off and on. The mode is on when the button is highlighted. See the **Set Speed Time** Page for details.
- The **Done** Button dismisses the page.

Zonal Authorization Page

Figure 4.16 Zonal Authorization Page

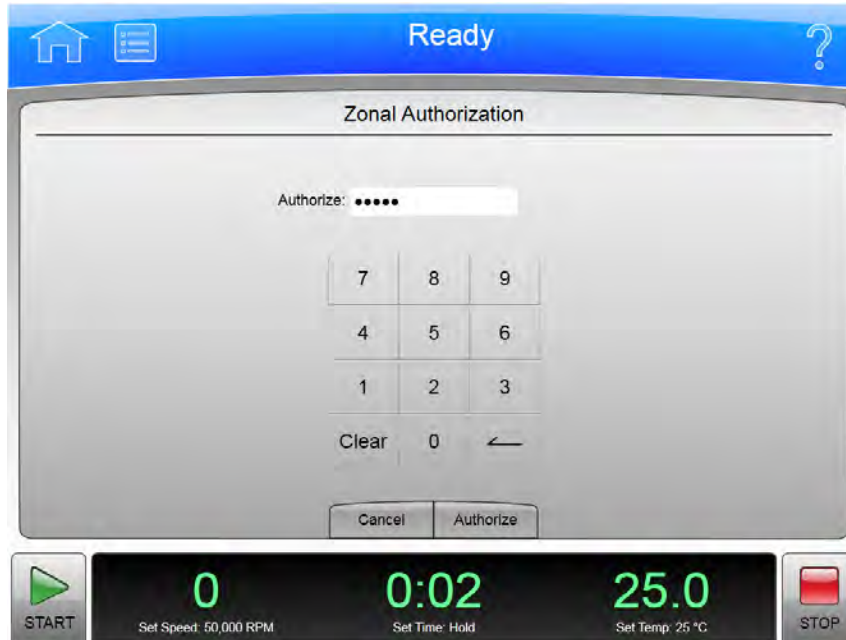

The **Zonal Authorization** Page appears when you select the **Zonal Operation** Button on the **Menu** Page, allowing you to use Zonal mode for the next run.

In addition to the Header Bar and the Footer Bar, the **Zonal Authorization** Page contains the following elements:

- The **Authorize** Display allows you to enter the authorization password (which is **1793**). For security reasons, the display shows bullets in place of the numbers you enter.
- The Keypad for entering the password.
- The **Cancel** Button dismisses the page without entering Zonal mode.
- The **Authorize** Button accepts the password you have entered and (if the password is the correct one) takes you to the [Zonal Operation Page](#), which replaces the **Home** Page while you are using Zonal mode.

Continuous Flow Authorization Page

Figure 4.17 Continuous Flow Authorization Page

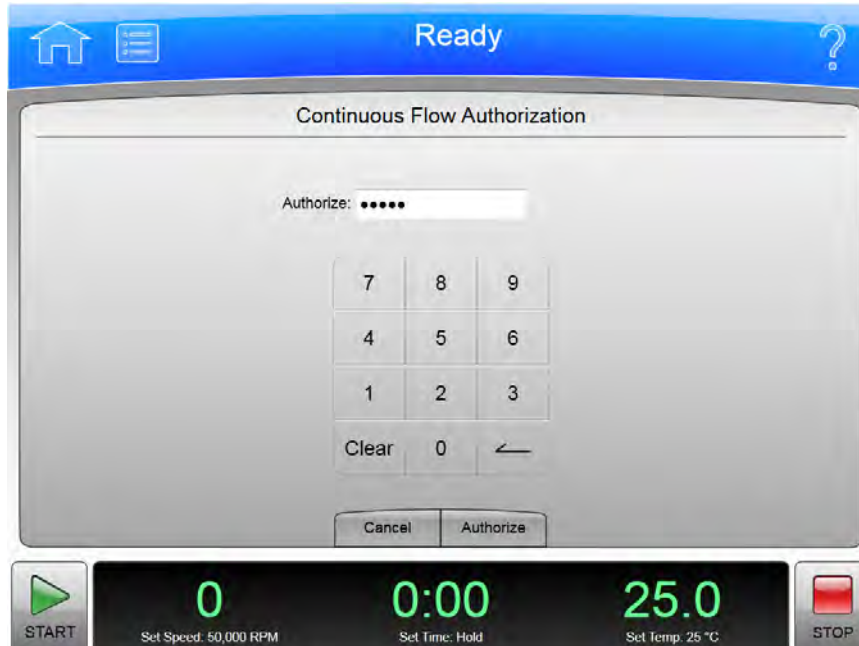

The **Continuous Flow Authorization** Page appears when you select the **Continuous Flow Operation** Button on the **Menu** Page, allowing you to use Continuous Flow mode for the next run.

In addition to the Header Bar and the Footer Bar, the **Continuous Flow Authorization** Page contains the following elements:

- The **Authorize** Display allows you to enter the authorization password (which is **1793**). For security reasons, the display shows bullets in place of the numbers you enter.
- The Keypad for entering the password.
- The **Cancel** Button dismisses the page without entering Continuous Flow mode.
- The **Authorize** Button accepts the password you have entered and (if the password is the correct one) takes you to the [Continuous Flow Operation Page](#), which replaces the **Home** Page while you are using Continuous Flow mode.

Service Login Page

Figure 4.18 Service Login Page

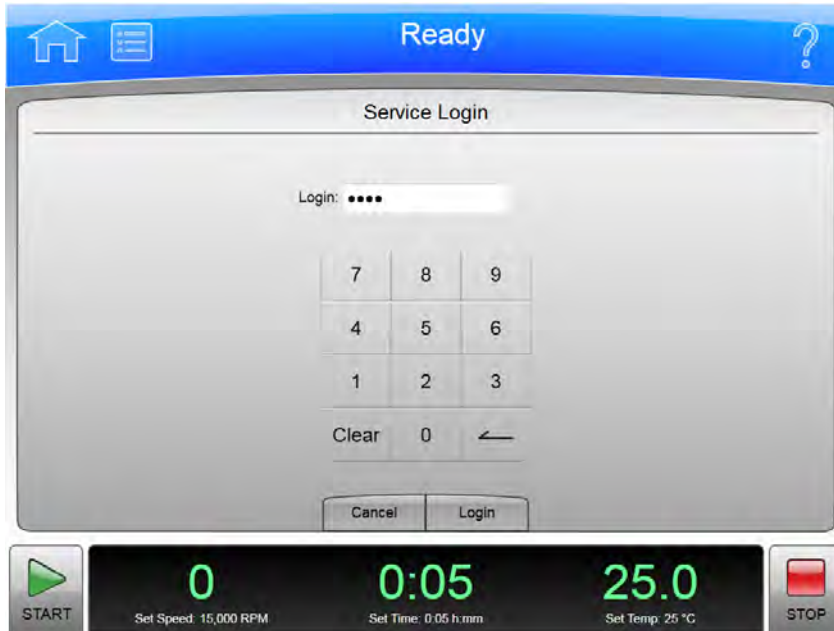

The **Service Login** Page appears when you select the **Service Mode** Button on the **Menu** Page.

This page is for service personnel only. If you accidentally find yourself on the **Service Login** Page, select the **Cancel** button to dismiss the page.

About Page

Figure 4.19 About Page

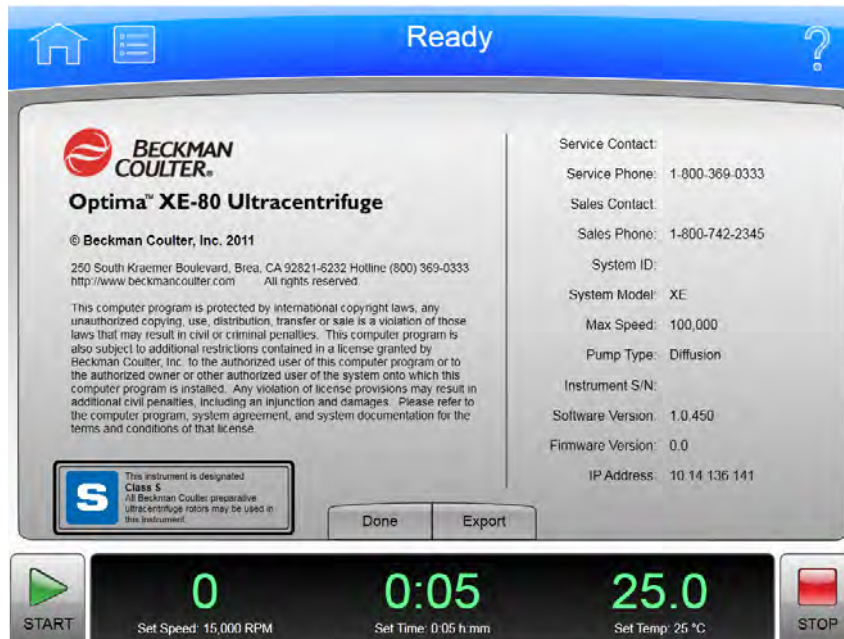

The **About** Page appears when you select the **About** Button on the **Menu** Page. This page presents system information about your instrument.

In addition to the Header Bar and the Footer Bar, the **About** Page contains the following operating elements:

- The **Done** button dismisses the page.
- The **Export** button takes you to the export **About** Page.

NOTE Do not remove the USB drive while a data transfer is in progress.

- The Available Drives list shows all the available USB drives. If the list is empty, the prompt “Insert USB Drive” appears below the list area. Select an available USB drive to receive the information.
- The **Export** Button transfers the information to the selected USB drive.

Rotor Catalog Page

Figure 4.20 Rotor Catalog Page



The **Rotor Catalog** Page appears when you select the **Rotor Catalog** Button on the **References** Page, allowing you to examine the detailed specifications for all the rotors available for your instrument.

This is different from the **Select Rotor and Labware** Page where you choose a rotor from the **Set Speed Page**.

In addition to the Header Bar and the Footer Bar, the **Rotor Catalog** Page contains the following elements:

- The List of Rotors on the left side of the screen shows all the available rotors for the instrument. You can scroll through this list and select a rotor to view the detailed information about it.
- The Rotor Details on the right side of the screen shows all the details for the selected rotor on the List of Rotors.
- The **Back** Button returns you to the **References** Page.
- The **Labware** Button takes you to the [Compatible Tubes for Rotor Page](#) to show you the labware for the selected rotor. Note that this is a small subset of all the labware shown on the **Labware Catalog** Page.

Labware Catalog Page

Figure 4.21 Labware Catalog Page



The **Labware Catalog** Page appears when you select the **Labware Catalog** Button on the **References** Page, allowing you to examine the detailed specifications for the labware available for the rotors your instrument can use.

This is different from the **Compatible Tubes for Rotor** Page, which shows only the labware available for a particular rotor when you are on the **Rotor Catalog** Page.

In addition to the Header Bar and the Footer Bar, the **Labware Catalog** Page contains the following elements:

- The List of Labware on the left side of the screen shows the labware by volume, type, and part number. Scroll through this list and select a particular labware to view the detailed information about it.
- The Labware Details on the right side of the screen shows all the details for the selected labware on the List of Labware.
- The **Back** Button returns you to the **References** Page.

Export User Manual Page

Figure 4.22 Export User Manual Page

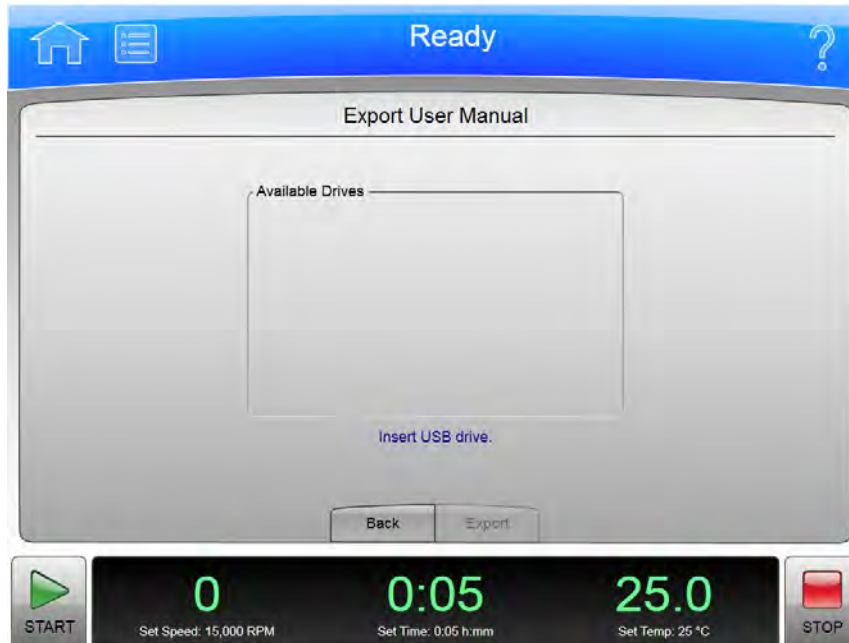

Selection of the **Export User Manual** Button allows you to copy the User Manual to a USB drive.

NOTE Do not remove the USB drive while a data transfer is in progress.

In addition to the Header Bar and the Footer Bar, the **Export User Manual** Page contains the following elements:

- The Available Drives list shows all the available USB drives. If the list is empty, the prompt “Insert USB Drive” appears below the list area. Select an available USB drive to receive the information.
- The **Back** Button returns you to the previous page.
- The **Export** Button transfers the information to the selected USB drive.

Set System Name Page

Figure 4.23 Set System Name Page

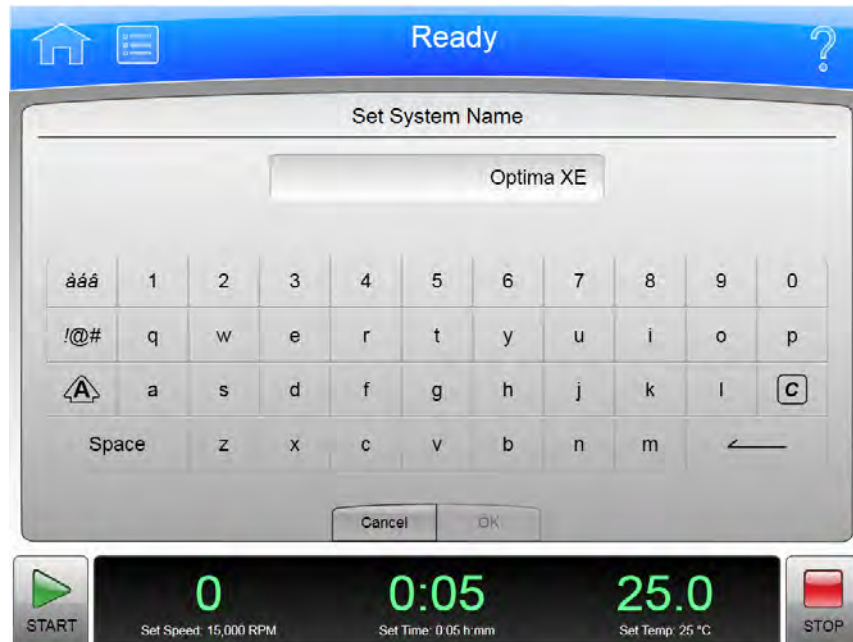

The **Set System Name** Page appears when you select the **Set System Name** Button on the [System Options Page](#), allowing you to set the System Name that appears in the Footer Bar on the **Home** Page.

In addition to the Header Bar and the Footer Bar, the **Set System Name** Page contains the following elements:

- The Set System Name Display shows the current System Name.
- The Keyboard for entering the name. It includes special keys for different character modes and corrections.
- The **Cancel** Button ignores any changes you have made and returns to the [System Options Page](#).
- The **OK** Button accepts your changes and returns to the [System Options Page](#).

The other keys work much like standard keyboard keys, except that the Shift and Special Character Set keys work as toggle (like a standard Caps Lock key). There are also Clear and Backspace keys with symbolic markings.

Set Date and Time Page

Figure 4.24 Set Date and Time Page



The **Set Date and Time** Page appears when you select the **Set Date and Time** Button on the [System Options Page](#), allowing you to set the instrument's internal time and date.

In addition to the Header Bar and the Footer Bar, the **Set Date and Time** Page contains the following elements:

- The Month-Day-Year controls let you set the date. Simply select the arrow button above one of the numbers to make it larger or select the button below to make it smaller.
- The Hour-Minute-AM/PM controls let you set the time. They work the same as the date controls except that the AM/PM value has only one arrow button to change the setting.
- The **Select Time Format** Buttons set the way time appears on the instrument. The 12 Hour format button selects a 12 hour display with AM and PM. The 24 Hour format button selects a 24 hour display without AM and PM notation. With some language selections, the 12 hour option may be unavailable.
- The **Cancel** Button discards any changes you made on this screen and returns to the [System Options Page](#).
- The **OK** Button accepts your changes and returns to the [System Options Page](#).

Set Sound Page

Figure 4.25 Set Sound Page

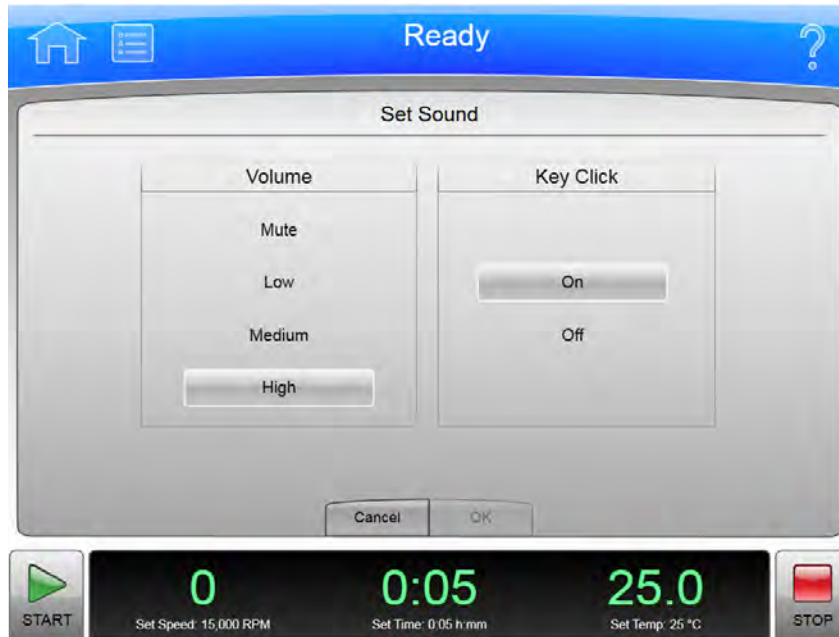

The **Set Sound** Page appears when you select the **Set Sound** Button on the [System Options Page](#), allowing you to set the sound volume and enable or disable the key click option.

In addition to the Header Bar and the Footer Bar, the **Set Sound** Page contains the following elements:

- The **Volume** buttons let you to choose one of the four system volumes: Mute (silent), Low, Medium, or High.
- The **Key Click** buttons let you choose if the key click is On or Off.
- The **Cancel** Button discards your changes and returns you to the [System Options Page](#) without changing the current volume and key click settings.
- The **OK** button accepts your changes and returns you to the [System Options Page](#).

Select Language Page

Figure 4.26 Select Language Page

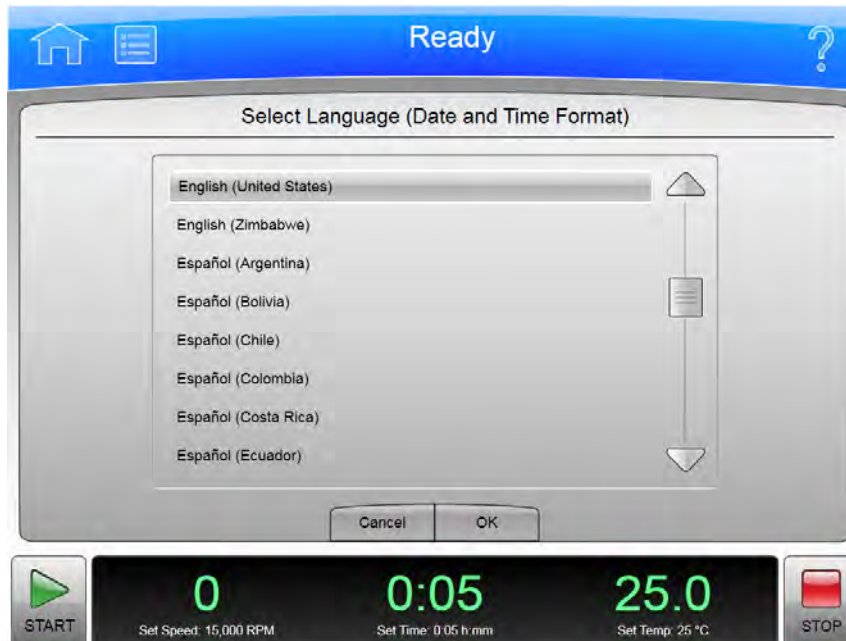

The **Select Language** Page appears when you select the **Select Language** Button on the [System Options Page](#), allowing you to choose the language the instrument uses in operations.

In addition to the Header Bar and the Footer Bar, the **Select Language** Page contains the following elements:

- The List of Languages shows all the languages and countries available for the instrument. Scroll through this list and select a language and country.
- The **Cancel** Button ignores your selection and returns you to the [System Options Page](#).
- The **OK** Button accepts your selection and returns you to the [System Options Page](#) with the newly-selected language active on all pages.

NOTE Be careful that you do not select a language that you do not understand. You will find it difficult to return to this page and restore the language setting (unless you can remember Menu, upper left button for Options, and then upper left button for Select Language).

Diagnostic History Page

Figure 4.27 Diagnostic History Page



The **Diagnostic History** Page appears when you select the **Diagnostic History** Button on the [System Options Page](#), allowing you to examine and export the details of incidents that caused a diagnostic message on the instrument (warnings and error messages).

In addition to the Header Bar and the Footer Bar, the **Diagnostic History** Page contains the following elements:

- The List of Events on the left side of the screen shows all the diagnostic events for the instrument. Scroll through this list and select an event to view the detailed information about it.
- The Event Details on the right side of the screen shows all the details for the selected event on the List of Events.
- The **Back** Button returns you to the [System Options Page](#).
- The **Export** Button takes you to the Export Diagnostic Page to let you copy the diagnostic history to a USB drive.

NOTE Do not remove the USB drive while a data transfer is in progress.

- The Available Drives list shows all the available USB drives. If the list is empty, the prompt "Insert USB Drive" appears below the list area. Select an available USB drive to receive the information.
- The **Export** Button transfers the information to the selected USB drive.

Compatible Tubes for Rotor Page

Figure 4.28 Compatible Tubes for Rotor Page

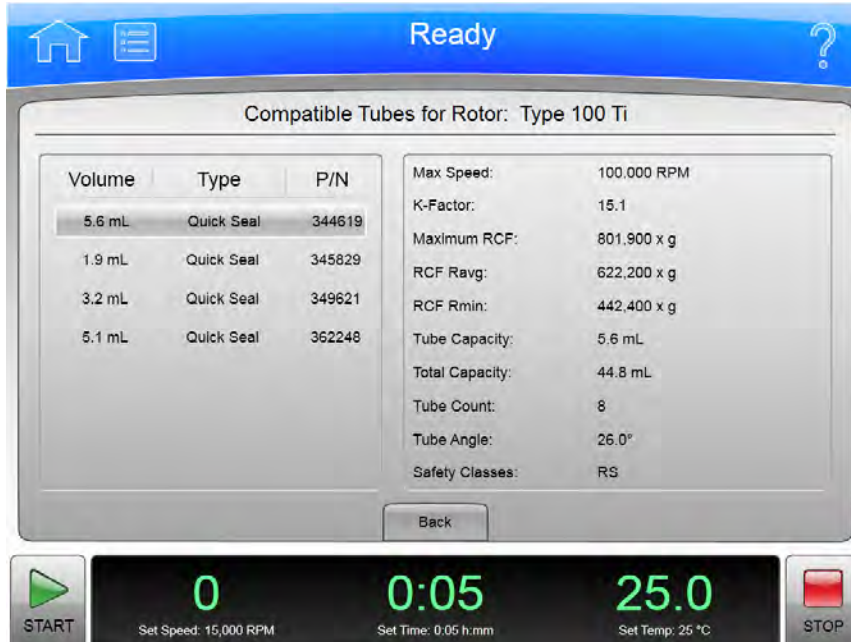

The **Compatible Tubes for Rotor** Page appears when you select the **Labware** Button on the **Rotor Catalog** Page, allowing you to examine the detailed specifications for the labware for the selected rotor.

This is different from the **Labware Catalog** Page, which shows the labware for all rotors.

In addition to the Header Bar and the Footer Bar, the **Compatible Tubes for Rotor** Page contains the following elements:

- The List of Labware on the left side of the screen shows the labware for the selected rotor by volume, type, and part number. Scroll through this list and select a particular labware to view the detailed information about it.
- The Labware Details on the right side of the screen show all the details for the selected labware on the List of Labware.
- The **Back** Button returns you to the **Rotor Catalog** Page.

Zonal Operation Page

Figure 4.29 Zonal Operation Page

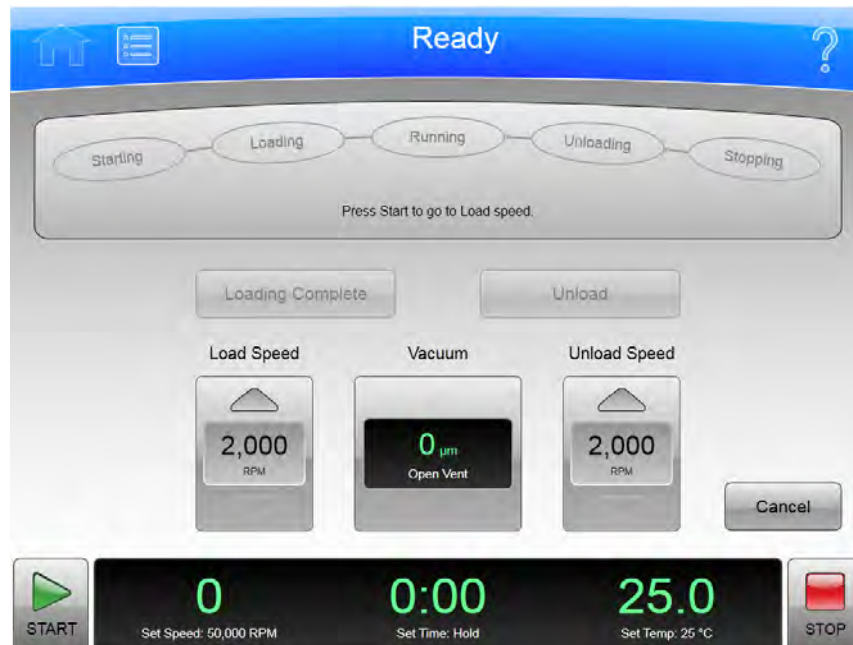

The **Zonal Operation** Page appears when you enter the correct password and select the **Authorize** Button from the **Zonal Authorization** Page, putting the instrument in Zonal mode.

When you use Zonal mode, the **Zonal Operation** Page replaces the **Home** Page until Zonal mode ends.

In addition to the Header Bar and the Footer Bar, the **Zonal Operation** Page contains the following elements:

- The Status Display shows the current step in the Zonal run procedure. See [Zonal and Continuous Flow Operation](#) in the [Operations](#) chapter for details.
- The **Loading Complete** Button ends the sample loading step and proceeds to the running step.
- The **Unload** Button terminates the running step early and proceeds to the sample unloading step.
- The Load Speed Display shows the sample loading speed. Use the **arrow** buttons above and below to increase or decrease the sample loading speed.
- The **Vacuum** Display/Button shows the current vacuum. You press it to begin evacuating and preconditioning the chamber at the beginning of a run, or to release the vacuum at the end of a run.
- The Unload Speed Display shows the sample unloading speed. Use the arrow buttons above and below to increase or decrease the sample unloading speed.
- The **Cancel** Button ends Zonal Mode before loading is complete and returns you to the **Home** Page.

Use the Footer Bar for setting the run speed, time, and temperature.

Continuous Flow Operation Page

Figure 4.30 Continuous Flow Operation Page

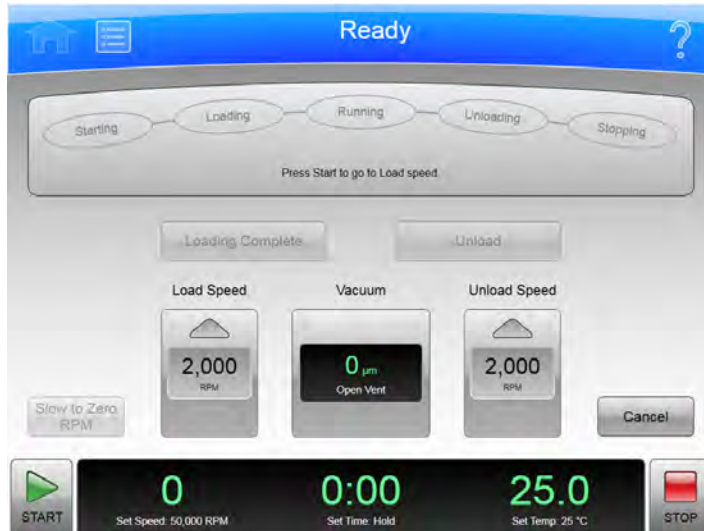

The **Continuous Flow Operation** Page appears when you enter the correct password and select the **Authorize** Button from the **Continuous Flow Authorization** Page, putting the instrument in Continuous Flow mode.

When you use Continuous Flow mode, the **Continuous Flow Operation** Page replaces the **Home** Page until Continuous Flow mode ends.

In addition to the Header Bar and the Footer Bar, the **Continuous Flow Operation** Page contains the following elements:

- The Status Display shows the current step in the Continuous Flow Run procedure. See [Zonal and Continuous Flow Operation](#) in the [Operations](#) chapter for details.
- The **Loading Complete** Button ends the sample loading step and proceeds to the running step.
- The **Unload** Button terminates the running step early and proceeds to the sample unloading step.
- The Load Speed Display shows the sample loading speed. Use the arrow buttons above and below to increase or decrease the sample loading speed.
- The **Vacuum** Display/Button shows the current vacuum. Press it to begin evacuating and preconditioning the chamber at the beginning of a run, or to release the vacuum at the end of a run.
- The Unload Speed Display shows the sample unloading speed. Use the arrow buttons above and below to increase or decrease the sample unloading speed.
- The **Slow to Zero rpm** Button is for preliminary steps which require bringing the rotor to a stop temporarily during the initial loading adjustments.
- The **Cancel** Button ends Continuous Flow Mode before loading is complete and returns you to the **Home** Page.

Use the Footer Bar for setting the run speed, time, and temperature.

Running Home Page

Figure 4.31 Running Home Page



The **Running Home** Page appears when there is an actual run in progress.

In addition to the Header Bar and the Footer Bar, the **Running Home** Page contains the following elements:

- The **Set Speed** Display shows the current Set Speed progress of the run in RPM or RCF. The last two digits are always zeroes when the speed is above 1000 RPM.
- The Set Time Display shows the current **Set Time** progress of the run in hours and minutes.
- The Set Temperature Display shows the current **Set Temperature** of the run in degrees Celsius.

The **Vacuum** Display/Button on the Footer Bar shows the current vacuum of the run that is in progress. The button toggles between evacuating and venting. Press it before starting a run (after the door is closed) to begin evacuating and pre-conditioning the chamber. Press it at the end of a run (assuming speed is less than 3000 rpm and decelerating) to release the vacuum (i.e., vent the chamber).

Press the **Accel** (acceleration) button on the Footer Bar to select a new profile for the acceleration of a run.

Press the **Decel** (deceleration) button on the Footer Bar to select a new profile for the deceleration of a run.

Maintenance and Troubleshooting

This chapter contains care and maintenance procedures to be performed regularly.

Field Service

For any maintenance not covered in this manual, contact Beckman Coulter Field Service for assistance. USA customers can call 1-800-742-2345. For international contacts, see the website at www.beckmancoulter.com or use the contact numbers on the inside front cover of this book.

NOTE It is your responsibility to decontaminate the instrument, as well as any rotors and accessories, before requesting service by Beckman Coulter Field Service.

Rotors and Labware

You also need to maintain rotors and labware. You can find the approved rotors and labware on the **Reference** Page as described in the previous chapter. Refer to the applicable rotor and labware documents for detailed instructions on their care.

Cleaning

The methods and materials used in the following procedures have been tested by Beckman Coulter and will not damage the instrument if used as instructed.

 **CAUTION**

Before using any other materials or methods, check with Beckman Coulter to verify that they will not damage the instrument.

Instrument Surfaces

Clean instrument surfaces using a cloth dampened with a mild detergent solution, such as Beckman Solution 555.



Be careful not to spill liquid on the instrument where electrical or mechanical components could get damaged.

Rotor Chamber

The rotor chamber is coated with epoxy resin paint. To clean the chamber, wipe it with a cloth dampened with a mild detergent, such as Beckman Solution 555.

Chamber Door O-ring

The chamber door O-ring is Buna N rubber. Clean it with a tissue or soft cloth every 3 or 4 months.

If the O-ring becomes worn or damaged, replace it. Lightly coat the new O-ring with silicone vacuum grease (335148) to ensure an optimum vacuum seal.

NOTE Instrument O-rings have **not** been designed as bioseals for aerosol containment.

Decontamination

If the instrument and/or accessories are contaminated with radioactive or pathogenic solutions, follow appropriate decontamination procedures as determined by your laboratory safety officer. Refer to Chemical Resistances (publication IN-175), or contact Beckman Coulter Field Service to ensure that the decontamination method does not damage any part of the instrument (or accessories).

Sterilization and Disinfection

 WARNING

While Beckman Coulter has tested these methods and found that they do not damage the instrument, no guarantee of sterility or disinfection is expressed or implied. When sterilization or disinfection is a concern, consult your laboratory safety officer regarding proper methods.

The top working surface is finished with urethane paint. The sides are finished with general purpose paint. You can use Ethanol (70%) on both these surfaces.

 WARNING

Ethanol is a volatile liquid that cannot be used on or near an operating instrument due to fire hazard.

Diagnostics/User Messages

When a condition arises that requires operator attention, the windshield turns yellow or red. A dialog will automatically open showing the diagnostic message. User messages communicate information about the ultracentrifuge or alert you to an abnormal condition. For a list of the possible malfunctions and their corrective actions, see [APPENDIX C, Diagnostics](#).

Retrieving Your Sample in Case of Power Failure

The instrument responds to a power failure during operations in two different ways:

- Power failed during a run and the rotor is still spinning when power is restored.
- Power failed during a run and the rotor has stopped when power is restored.

During a Run

If a power failure occurs during a run, the rotor begins to decelerate with the brake off. The corrected run time is determined when power is restored and, if the set run time has not elapsed, the run will resume as described. Note that a rotor decelerating without the brake may take hours to come to a complete stop.

Rotor Spinning at Restoration

If the rotor is still spinning when power is restored, the instrument takes the following steps:

- Return to the set speed.
- Resume incrementing the run timer.
- Set a diagnostic message to alert you that a power failure occurred during the run.

Rotor Stopped at Restoration

If the rotor has stopped spinning when power is restored, the instrument cancels the run and sends a diagnostic message to alert you to that the run was cancelled due to a power failure,

Getting Access to the Sample

If a power failure lasts for several hours, you may have to remove the sample from the rotor while there is no power to the instrument. The procedure requires removing the front panel, which should be done only by qualified service personnel.

WARNING

Any maintenance procedure requiring removal of a panel exposes the operator to the possibility of electrical shock and/or physical injury. If any such procedure becomes necessary, turn the power switch OFF, and then disconnect the instrument from the main power source by removing its power plug from the receptacle. Refer the maintenance to qualified service personnel.

To get access to the rotor, follow these steps:

- Disconnect the power by removing its power plug from the receptacle.
- Remove the front panel.
- Vent the chamber to release the vacuum.
- Release the door lock.
- Open the door.

WARNING

The following procedure should be performed only when absolutely necessary and only by qualified service personnel.

Check Power

Check that the power switch is in the OFF position and the instrument is disconnected from the power (i.e., the power plug is removed from its receptacle).

Remove the Front Panel

To remove the front panel:

-
- 1 Locate the three front panel latch screws and use a small flat-head screwdriver to turn each latch screw counter-clockwise until each one is loose. Refer to [Figure 5.1](#).

Figure 5.1 Panel screws and Tabs

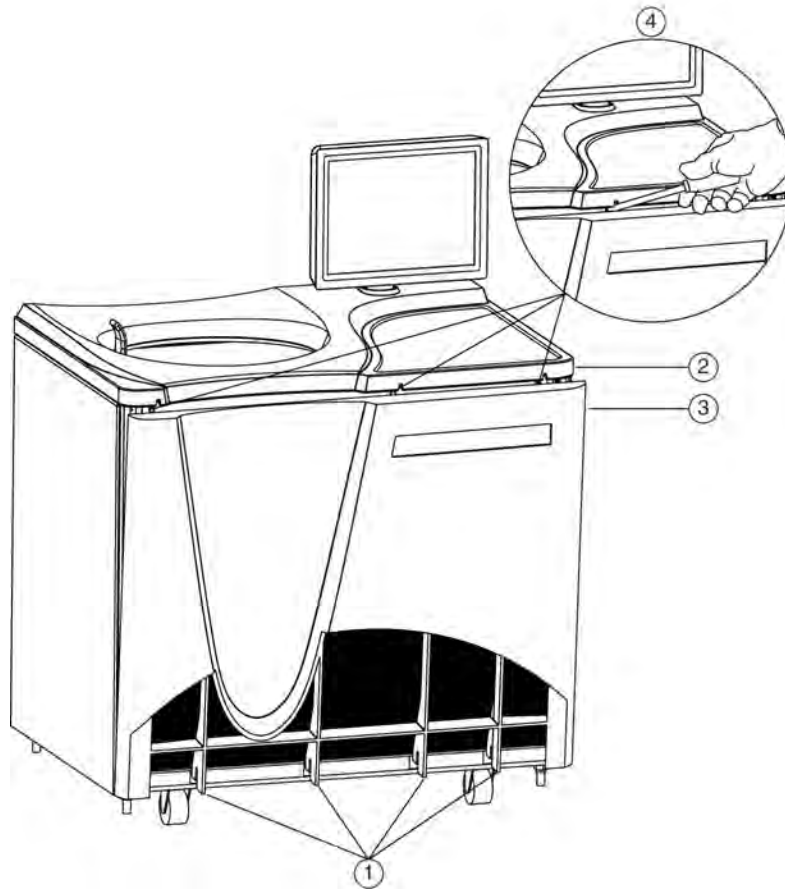

- | | |
|---------------|-----------------|
| 1. Panel Tabs | 3. Front Panel |
| 2. Top Panel | 4. Latch Screws |

2 When all three latch screws are loose, use your hand to lift the top panel until it pops loose.

3 Lift the front panel until it is free and tilt the top edge towards you.

4 Lift the front panel off the tabs that secure it at the bottom and put it in a safe place.

WARNING

When working on the inside of the instrument, be careful not to touch any wires or circuitry.

- 5 Determine the instrument's vacuum configuration. There are two possible configurations:
- **Configuration "A"** will vent the vacuum through a vent port cap (refer to [Figure 5.2](#)).
 - **Configuration "B"** will vent the vacuum through a solenoid release screw (refer to [Figure 5.3](#)).

Figure 5.2 Internal Parts — Configuration "A" vents through the port cap

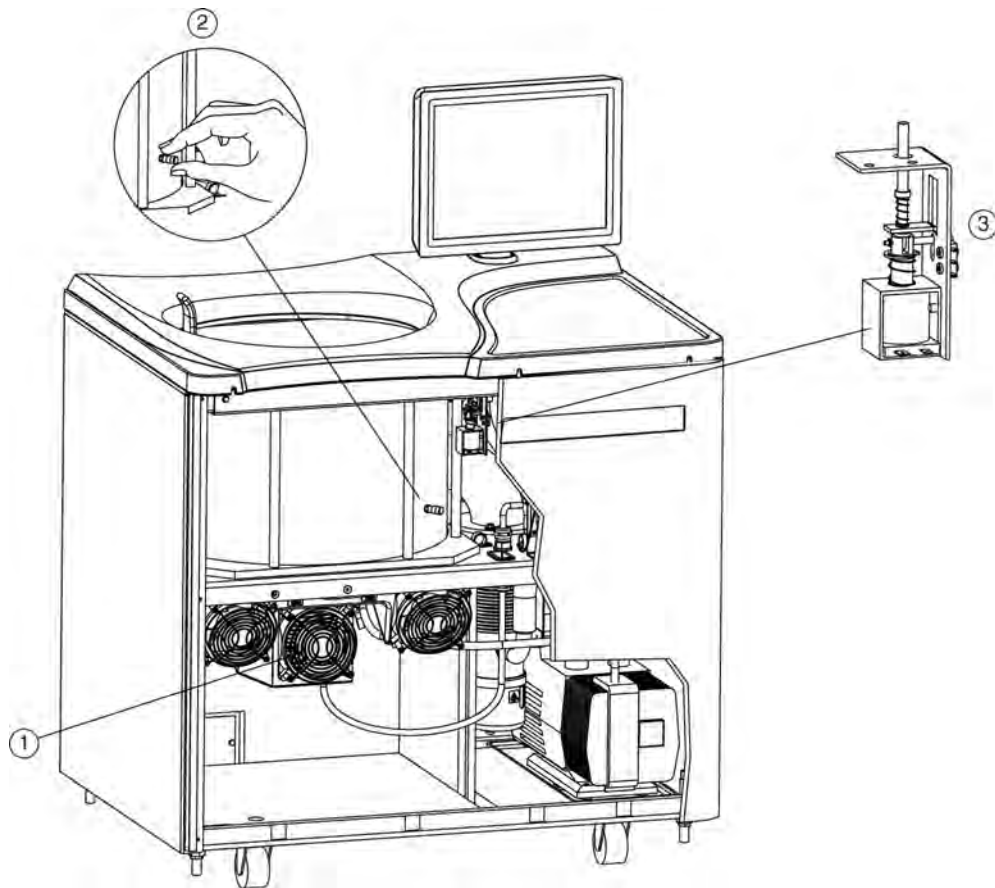

1. Fan Housing
2. Vacuum Vent Port Cap
3. Door Interlock Assembly

Figure 5.3 Internal Parts — Configuration “B” vents through the vacuum solenoid release screw

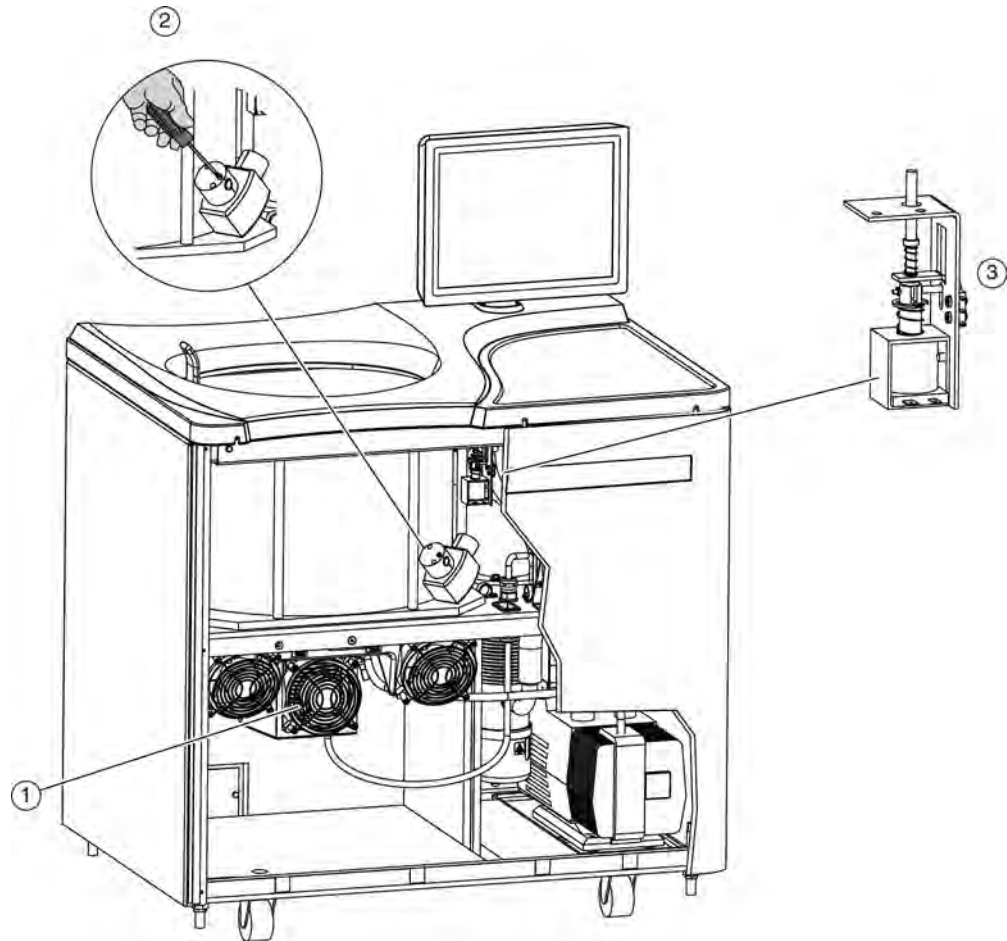

1. Fan Housing
2. Vacuum solenoid release screw
3. Door Interlock Assembly

Also refer to *To Vent the Chamber- Configuration “A” with vent port cap*., and *To Vent the Chamber- Configuration “B” with solenoid release screw*..

- 6 Listen carefully for any sounds coming from the drive and touch the fan housing to feel for vibrations. If you detect any sounds or vibrations, do not go further. The rotor is still spinning and you must wait for it to come to a stop.

Vent the Chamber

Although you checked for noise and vibration, there is still a possibility that the rotor is still spinning. If it is still spinning, you can hear a whining noise when you begin to vent the chamber. If you hear the whining noise when you begin to vent the chamber, you must close the port immediately and wait for the rotor to come to a stop. The following steps describe the procedure you must follow for each configuration:

To Vent the Chamber- Configuration “A” with vent port cap:

- 1** Locate the vacuum vent port cap on the side of the rotor chamber.

- 2** Turn the cap very slowly counter-clockwise until you can hear the hiss of air entering the chamber.

- 3** If you hear a whining noise, immediately turn the cap clockwise to close it and wait until the rotor has had time to come to a stop (at least an hour) before attempting to vent the chamber again.

- 4** When air flows into the chamber without a whining noise, remove the cap completely.

To Vent the Chamber- Configuration “B” with solenoid release screw:

- 1** Locate the vacuum solenoid release screw on the side of the rotor chamber.

- 2** Using a screwdriver, turn the screw very slowly clockwise until you can hear the hiss of air entering the chamber.

- 3** If you hear a whining noise, immediately turn the screw counter-clockwise to close it and wait until the rotor has had time to come to a stop (at least an hour) before attempting to vent the chamber again.

- 4** When air flows into the chamber without a whining noise, continue to turn the screw clockwise.

Release the Door Lock

Locate the door interlock assembly. Pull down on the interlock pin until it locks in the downward position.

Open the Door

Open the chamber door carefully. If the rotor is still spinning, even at a slow speed, close the door and wait.

WARNING

NEVER attempt to slow or stop the rotor by hand.

With the door open and the rotor stopped, you can retrieve your sample.

WARNING

Do not attempt to run the instrument before restoring it to a safe operating condition as described in the following section.

Restoring the Instrument to Operating Condition

After retrieving your sample, restore the instrument to operating condition as follows:

- 1 Close the chamber door.
- 2 Close the vent:
 - **For Configuration “A” with vent port cap:** Replace and tighten the vacuum vent port cap. It should be snug, but do not overtighten it.
 - **For Configuration “B” with solenoid release screw:** Turn the screw counter-clockwise, but do not overtighten it.
- 3 Place the front panel in the tilted position with the top edge toward you, the sides aligned with the sides of the instrument, and the tabs at the bottom edge inserted into the lip at the base of the instrument.
- 4 Lift the front edge of the top panel a few inches and insert the upper edge of the front panel under it. Push back gently to engage the tabs, then push down.
- 5 For each of the three latch screws, use the small flat-head screwdriver to turn it clockwise until snug.
- 6 After the panels are all secure, reconnect the instrument to the power supply.

The instrument is again ready for use when power is restored.

Storage and Transportation

To ensure that the instrument does not get damaged, contact Beckman Coulter Field Service for specific instructions and/or assistance in preparing the equipment for transport or long-term storage.

Supply List

Contact Beckman Coulter Sales for assistance ordering parts and supplies. Customers in the United States call 1-800-742-2345. For international contacts, see the website at www.beckmancoulter.com or use the contact numbers on the inside front cover of this book. A partial list of supplies is given below for your convenience. See the Beckman Coulter *Ultracentrifuge Rotors, Tubes & Accessories* catalog (BR-8101, available at www.beckmancoulter.com) for detailed information on ordering rotors, tubes, and accessories.

Replacement Parts

Description	Part Number
Chamber O-ring	801778
Rotor Pad	B42711

Supplies

Description	Part Number
Silicone vacuum grease (2 oz)	335148
Beckman Solution 555 (1 qt)	339555
Logbook for preparative ultracentrifuges	330049
Master rotor logbook	339587

NOTE For MSDS information, go to the Beckman Coulter website at www.beckmancoulter.com

Preinstallation Requirements

Overview

NOTE Do not attempt to install or turn on the power to the Optima XE. Its purchase price includes installation by Beckman Coulter personnel. Installation by anyone other than authorized Beckman Coulter personnel invalidates the instrument warranty.

Preinstallation requirements have been sent prior to shipment of the instrument. Copies are also attached to the outside of the shipping container. The following information is provided in case the instrument must be relocated. Contact Beckman Coulter Field Service to adjust and level the instrument if it must be moved. The pads on each leveling leg are designed to prevent possible rotation of the instrument in the case of a rotor mishap.

Space Requirements

Space requirements include specifications for safety, ventilation, and temperature.

Safety

IMPORTANT This unit or system is provided with fixed trip limits and shall not be aggregated above 30kW on a single point of common connection.

IMPORTANT To reduce the risk of fire, connect only to a circuit provided with 30 amperes maximum branch circuit overcurrent protection in accordance with the National Electrical Code, ANSI/ NFPA 70.

IMPORTANT Additionally:

- Equipment shall be installed on a dedicated branch circuit.
- The branch circuit protection shall be one that is suitable to be back-fed.
- Circuit breakers that are marked with a “line” and “load” have not been evaluated to be back-fed.

Locate the ultracentrifuge in a clean, safe, uncluttered environment free of volatile vapors that could be ignited by the operation of the centrifuge.

WARNING

Do not place the ultracentrifuge near areas containing flammable reagents or combustible fluids. Vapors from these materials could enter the ultracentrifuge air system and be ignited by the motor.

Although the possibility of a rotor failure is remote, your planning should include a safety space around the instrument of 12 inches (30.5 cm.) to allow for the movement of the instrument in the event that a rotor failure occurs at high rotational speed. If you decide to install the instrument in an area where furniture, equipment, or a wall is within this safety space, you run the risk of damage to anything within this space in the event of a rotor failure.

WARNING

Maintain a 30-cm (1-ft.) clearance envelope around the ultracentrifuge while it is running. No persons or any hazardous materials should be within this clearance boundary while the ultracentrifuge is operating except to change operating controls, if required.

Figure A.1 Safety and ventilation space

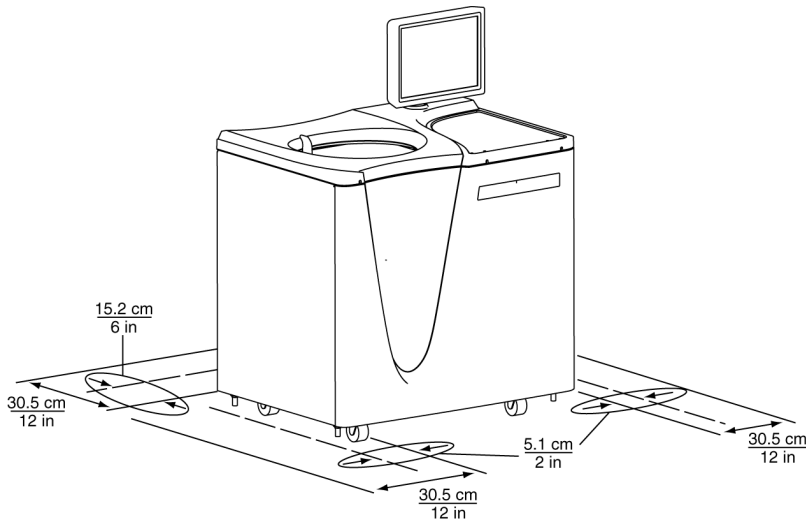

Ventilation

If you choose to install the instrument with less than the 12 in./30.5 cm. safety clearance, you must at least provide a required ventilation and service access clearance of 6 in. (15.2 cm.) behind the instrument and 2 in. (5.1 cm.) on each side. In addition, the ultracentrifuge must have adequate air ventilation to ensure compliance to local requirements for vapors produced during operation.

Temperature

The instrument operates within specifications in a laboratory with ambient temperatures ranging from 10 to 35°C.

Electrical Requirements

Instrument Rating:	200 to 240 VAC, 50/60 Hz, 20 A
Power Line Range: (Input Ratings)	180 to 264 VAC, 60 or 50 Hz (single-phase), 30 A
Power Line Range: (Output Ratings)	200 to 240 VAC, 50/60Hz, 8.5A

IMPORTANT AC output is not bonded to earth ground.

To reduce risk of electrical shock, this equipment uses a three-wire electrical cord (3.05 m; 10 ft.) and plug (see [Figure A.2](#)) to connect the equipment to earth ground. In regions where the instrument is supplied with an unterminated cord, a plug that meets local electrical and safety requirements must be supplied. (Contact your local Beckman Coulter office for specific information regarding these requirements.) See [Table A.1](#) for the required wire connections. Make sure that the matching wall outlet is located near the centrifuge and is easily accessible, properly wired and earth-grounded.

NOTE The power plug serves as the Disconnecting Device and must remain easily accessible.

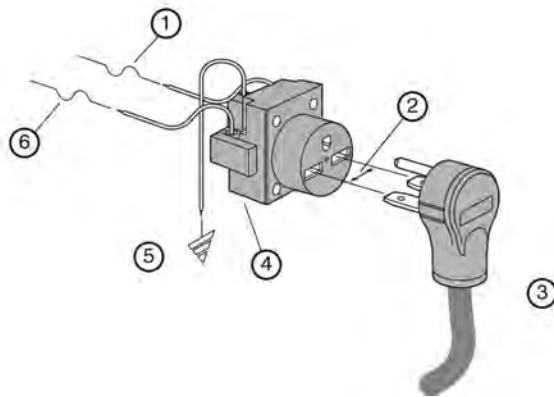

Figure A.2 Electrical Connection



- | | |
|--------------------------------|--------------------------------|
| 1. 30-ampere Circuit Protector | 4. Wall Outlet: NEMA 6-30 R |
| 2. Measured Line Voltage | 5. Earth Ground |
| 3. North American Plug | 6. 30-ampere Circuit Protector |

To ensure safety, the instrument should be wired to a remote emergency switch (preferably outside the room where the ultracentrifuge is housed, or adjacent to the exit from that room). Refer to Table A.1.

Table A.1 Required Wire Connections

Wire Insulation Color	Terminal	Symbol	
		Harmonized	North American
Green/Yellow	Earth ground		
Light Blue	Neutral	N	L
Brown	Live or Line	L	L

Special Warranty for the Optima XE

Special Warranty

Subject to the exceptions and upon the conditions specified below, Beckman Coulter, Inc., agrees to correct, either by repair, or, at its election, by replacement, any defects of material or workmanship which develop within one (1) year after delivery of the Optima Ultracentrifuge (the product), to the original Buyer by Beckman Coulter, or by an authorized representative, provided that investigation and factory inspection by Beckman Coulter discloses that such defect developed under normal and proper use.

Some components and accessories by their nature are not intended to and will not function for as long as one (1) year. If any such component or accessory fails to give reasonable service for a reasonable period of time, Beckman Coulter will repair or, at its election, replace such component or accessory. What constitutes either reasonable service and a reasonable period of time shall be determined solely by Beckman Coulter.

Replacement

Any product claimed to be defective must, if requested by Beckman Coulter be returned to the factory, transportation charges prepaid, and will be returned to Buyer with the transportation charges collect unless the product is found to be defective, in which case Beckman Coulter will pay all transportation charges.

Beckman Coulter makes no warranty concerning products or accessories not manufactured by it. In the event of failure of any such product or accessory, Beckman Coulter will give reasonable assistance to the Buyer in obtaining from the respective manufacturer whatever adjustment is reasonable in light of the manufacturer's own warranty.

Damage to the instrument while operating a rotor not of Beckman Coulter manufacture is not covered by warranty or service contract terms. Further, Beckman Coulter shall be released from all obligations under all warranties either expressed or implied, if the product covered hereby is repaired or modified by persons other than its own authorized service personnel, unless such repair is made by others who meet qualifications similar to those required of Beckman Coulter's service personnel, or unless such repair in the sole opinion of Beckman Coulter is minor, or unless such modification is merely the installation of a new Beckman Coulter plug-in component for such product.

Special Drive Warranty

During the instrument warranty period (one year), there will be no charge for drive replacement if the drive unit is installed, serviced, and operated in accordance with the conditions listed below. During the drive's second through tenth year of use there is a prorated drive replacement price based on years of use if the drive unit is installed, serviced, and operated in accordance with the conditions listed below.

Drive replacement price for units not under service contract = current drive exchange price
 $\times \left(\frac{\text{years of use}}{10} \right) + \text{labor and travel.}$

NOTE For details of drive coverage with a service contract, contact your local Beckman Coulter service representative

Conditions

1. The drive has been operated only within its rated speed and temperature ranges.
2. The drive unit has not been subjected to unequal loading, improper rotor installation, corrosion from material spilled onto the hub or accumulated in the chamber of the instrument.
3. The drive unit has not been disassembled, modified, or repaired, except by Beckman Coulter personnel.
4. The drive unit was installed by a Beckman Coulter Field Service representative.
5. The instrument in which the drive unit has been used and operated, and its associated rotors, were manufactured by Beckman Coulter and serviced only by Beckman Coulter Field Service representatives.

If the above conditions are not met, the full appropriate exchange price for the drive will be charged.

Disclaimer

IT IS EXPRESSLY AGREED THAT THE ABOVE WARRANTY SHALL BE IN LIEU OF ALL WARRANTIES OF FITNESS AND OF THE WARRANTY OF MERCHANTABILITY AND THAT BECKMAN COULTER, INC. SHALL HAVE NO LIABILITY FOR SPECIAL OR CONSEQUENTIAL DAMAGES OF ANY KIND WHATSOEVER ARISING OUT OF THE MANUFACTURE, USE, SALE, HANDLING, REPAIR, MAINTENANCE, OR REPLACEMENT OF THE PRODUCT.

Diagnostics

Overview

This section lists possible malfunctions and corrective actions. Maintenance procedures are described in Chapter 5, [Maintenance and Troubleshooting](#).

For any maintenance not covered in this manual, contact Beckman Coulter Field Service for assistance. USA customers can call 1-800-742-2345. For international contacts, see the website at www.beckmancoulter.com or use the contact numbers on the inside front cover of this book.

NOTE It is your responsibility to decontaminate the ultracentrifuge, as well as any rotors and/or accessories, before requesting service by Beckman Coulter Field Service.

Diagnostics/User Messages Chart

Refer to the chart below for a list of possible malfunctions and their corrective actions.

Table C.1 Diagnostics/User Messages Chart

Message	Definition/Result	Recommended Action
D100 - Turn off power immediately	Instrument cannot trip breaker	Call Beckman Coulter Field Service.
D101 - SBC Communications	Single board computer boot error	Call Beckman Coulter Field Service.
D102 - SCB Communications	Communications error	Call Beckman Coulter Field Service.
D103 - Inverter Communications	Inverter I ² C error	Call Beckman Coulter Field Service.
D104 - Inverter Communications	Inverter ADC I ² C error - U21	Call Beckman Coulter Field Service.
D105 - Inverter Communications	Inverter I ² C I/O Expander error	Call Beckman Coulter Field Service.

Table C.1 Diagnostics/User Messages Chart (Continued)

Message	Definition/Result	Recommended Action
D107 - Inverter Communications	TEM ADC I ² C error - U24	Call Beckman Coulter Field Service.
D108 - Network Communications	D108 - Network Communications	Be sure external devices are turned on.
D109 - Network Communications	Network error - ethernet disconnected	Be sure network cable is plugged in.
D110 - Network Communications	Network error - cannot renew IP address	Check to see if network is active.
D111 - System Data Error	Data error	Note: If recovery fails, this condition will result in a 200 minute delay before the diagnostic can be cleared and the door opened. The power must be left on, until the delay period is completed. Call Beckman Coulter Field Service.
D112 - USB Port	USB import/export error	USB device may be full or removed too quickly. Save again with another USB device..
D113 - Touch Screen Not Detected	Touch Screen USB cable not connected	Be sure USB touch screen cable is connected. If problem persists, call Beckman Coulter Field Service.
D114 - Code error	Bad checksum on code flash	Call Beckman Coulter Field Service.
D115 - Code error	Corrupted data flash	Note: This condition will result in a 200 minute delay before the diagnostic can be cleared and the door opened. The power must be left on, until the delay period is completed. Call Beckman Coulter Field Service.
A117 - Alert: Printer error	No printer or printer driver	Be sure printer is turned on and drivers are installed. If problem persists, call Beckman Coulter Field Service.
A118 - Alert: Hard drive error	Enhanced Write Filter disabled	Call Beckman Coulter Field Service.
D119 - SBC Communication	Unable to open serial port	Call Beckman Coulter Field Service.
A120 - Alert: Simulator	Simulator not found	Call Beckman Coulter Field Service.

Table C.1 Diagnostics/User Messages Chart (*Continued*)

Message	Definition/Result	Recommended Action
D121 - Internal software error	Software error	Call Beckman Coulter Field Service.
A122 - Alert: Firmware error	Firmware error caused reset	Call Beckman Coulter Field Service.
D123 - UI Communications	Communications error	Call Beckman Coulter Field Service.
A124 - Alert: Hard drive space low	Hard drive is 90% full	Backup files soon. Call Beckman Coulter Field Service.
D125 - SBC Communications	Communications parameters are not compatible	Call Beckman Coulter Field Service.
A200 - Alert: AC Power Loss - Run continued	AC Power Loss - Run continued	None
A201 - Alert: AC Power Loss - Run stopped	AC Power Loss - Run, Delayed Run, or Program stopped	None
D202 - Bus Current	Bus current measures zero (<0.1A)	Call Beckman Coulter Field Service.
D203 - Bus Voltage	Bus voltage too high (>220VDC) or Bus voltage too low (<180VDC)	Call Beckman Coulter Field Service.
D204 - Power Supply	Inverter +18V supply too high (>19.8VDC)	Call Beckman Coulter Field Service.
D205 - Power Supply	Inverter +18V supply too low (<16.2VDC)	Call Beckman Coulter Field Service.
D206 - Power Supply	Inverter +5V supply too high (>5.5VDC)	Call Beckman Coulter Field Service.
D207 - Power Supply	Inverter +5V supply too low (<4.5VDC)	Call Beckman Coulter Field Service.
D208 - Power Supply	Inverter -5V supply too high (>-4.5VDC)	Call Beckman Coulter Field Service.
D209 - Power Supply	Inverter -5V supply too low (<-5.5VDC)	Call Beckman Coulter Field Service.
D210 - Power Supply	SCB +12V supply too high (>13.2VDC) or SCB +12V supply too low (<10.8VDC)	Call Beckman Coulter Field Service.
D211 - Power Supply	SCB +3.3V supply too high (>3.63VDC)	Call Beckman Coulter Field Service.

Table C.1 Diagnostics/User Messages Chart (Continued)

Message	Definition/Result	Recommended Action
D212 - Power Supply	SCB analog +3.3V supply too high (>3.63VDC) or SCB analog +3.3V supply too low (<2.97VDC)	Call Beckman Coulter Field Service.
D213 - Power Supply	System +24V supply too high (>26.4VDC) or System +24V supply too low (<21.6VDC)	Call Beckman Coulter Field Service.
D214 - Power Supply	System +5V supply too high (>5.5VDC)	Call Beckman Coulter Field Service.
D216 - AC Power Out of Range	AC Power Out of Range	Check electrical power source.
A217 - Alert: AC Power Voltage Sag	AC voltage sagged below 180Vac or AC voltage/frequency is out of range during braking	None
D300 - Rotor Speed	Rotor speed exceeds maximum rated speed	Call Beckman Coulter Field Service.
A301 - Alert: Rotor Speed Adjusted	Rotor set speed adjusted	None
A302 - Alert: Inertia Calibration	Inertia calibration failure	Call Beckman Coulter Field Service.
D303 - Speed Signals	Overspeed timing signal is <9 counts/revolution or >47 counts/revolution, or overspeed timing signal is unstable	<ol style="list-style-type: none"> 1. Check the condition of the rotor overspeed disk. 2. Make sure the rotor is installed properly. 3. Verify the rotor load is within limits specified in the rotor manual.
D304 - Speed Signals	No tachometer signal	<p>NOTE This condition will result in a 200-minute delay before the diagnostic can be cleared and the door opened. The power must be left on, until the delay period is completed.</p> <ol style="list-style-type: none"> 1. Make sure the rotor is installed properly. 2. Check the condition of the rotor overspeed disk. 3. Verify the rotor load is within limits specified in the rotor manual. 4. If the problem persists, call Beckman Coulter Field Service.
D305 - Inertia	Inertia check failure	Be sure rotor is loaded properly.

Table C.1 Diagnostics/User Messages Chart (*Continued*)

Message	Definition/Result	Recommended Action
A400 - Alert: Vacuum Calibration	Vacuum calibration failure	Call Beckman Coulter Field Service.
A401 - Alert: Slow Vacuum	Vacuum exceeds 750 microns after 4 minutes	<ol style="list-style-type: none"> 1. Make sure door o-ring is clean, undamaged, and properly lubricated. 2. Check for sample leakage. Clean and dry the rotor chamber if needed. 3. If the problem persists, call Beckman Coulter Field Service.
D402 - Slow Vacuum	Vacuum not <20 microns after 20 minutes	<ol style="list-style-type: none"> 1. Make sure door o-ring is clean, undamaged, and properly lubricated. 2. Check for sample leakage. Clean and dry the rotor chamber if needed. 3. If the problem persists, call Beckman Coulter Field Service.
D403 - Lost Vacuum	Vacuum >750 microns for 1 minute after being <750 microns	<ol style="list-style-type: none"> 1. Make sure door o-ring is clean, undamaged, and properly lubricated. 2. Check for sample leakage. Clean and dry the rotor chamber if needed. 3. If the problem persists, call Beckman Coulter Field Service.
D404 - Lost Vacuum	Vacuum >50 microns for 10 minutes after being <20 microns	<ol style="list-style-type: none"> 1. Make sure door o-ring is clean, undamaged, and properly lubricated. 2. Check for sample leakage. Clean and dry the rotor chamber if needed. 3. If the problem persists, call Beckman Coulter Field Service.
D407 - Vacuum Vent	Vacuum vent solenoid not connected	Call Beckman Coulter Field Service.
D408 - Vacuum Vent	Vacuum vent can not be opened	Call Beckman Coulter Field Service.
D500 - Temperature Control	Ambient thermistor open	Call Beckman Coulter Field Service.
D501 - Temperature Control	Ambient thermistor shorted	Call Beckman Coulter Field Service.
D502 - Temperature Control	Ambient temperature out of range (<10°C or >35°C)	Adjust room temperature before operating.
D503 - Temperature Control	Can thermistor not connected	Call Beckman Coulter Field Service.

Table C.1 Diagnostics/User Messages Chart (Continued)

Message	Definition/Result	Recommended Action
D504 - Temperature Control	Can thermistor shorted	Call Beckman Coulter Field Service.
D505 - Temperature Control	Can temperature out of limits (<-30°C or >70°C)	Call Beckman Coulter Field Service.
D506 - Temperature Control	TEM voltage too high	Call Beckman Coulter Field Service.
D507 - Temperature Control	TEM voltage too low	Call Beckman Coulter Field Service.
D508 - Temperature Control	TEM impedance too low	Call Beckman Coulter Field Service.
D509 - Temperature Control	TEM impedance too high	Call Beckman Coulter Field Service.
D510 - Temperature Control	Rotor temperature error rate of change is not decreasing and rotor temperature is greater than 10°C from set temperature after running for 15 minutes.	Call Beckman Coulter Field Service.
D512 - Temperature Communications	D512 - Temperature Communications	Call Beckman Coulter Field Service.
D513 - Temperature Communications	No communications - TEM I ² C	Call Beckman Coulter Field Service.
D514 - Temperature Communications	No communications - thermopile	Call Beckman Coulter Field Service.
D600 - DriveDrive fault	Drive fault	Call Beckman Coulter Field Service.
D601 - Drive	Bus current too high (>30A)	Call Beckman Coulter Field Service.
D602 - Drive Temperature	Drive temperature >69°C	Call Beckman Coulter Field Service.
D603 - Damper	Damper coil status error	Call Beckman Coulter Field Service.
D604 - CF-32 Rotor Oil Level	CF-32 oil level error	Make sure the rotor oil level switch is installed on the back panel for CF-32 operation. Add oil to CF-32 rotor.
D605 - Drive Performance	Abnormal rate of change in speed	Call Beckman Coulter Field Service.

Table C.1 Diagnostics/User Messages Chart (Continued)

Message	Definition/Result	Recommended Action
D606 - Drive Performance	Abnormal tachometer frequency	<p>NOTE This condition will result in a 200-minute delay before the diagnostic can be cleared and the door opened. The power must be left on, until the delay period is completed.</p> <ol style="list-style-type: none"> 1. Make sure the rotor is installed properly. 2. Check the condition of the rotor overspeed disk. 3. Verify the rotor load is within limits specified in the rotor manual. 4. If the problem persists, call Beckman Coulter Field Service.
D607 - Drive Performance	Drive frequency error	Call Beckman Coulter Field Service.
D608 - Drive Performance	Tachometer frequency > 103K rpm	Call Beckman Coulter Field Service.
A700 - Alert: Imbalance	Imbalance detector error	<ol style="list-style-type: none"> 1. Make sure the rotor is installed properly. 2. Verify the rotor load is within limits specified in the rotor manual. 3. If the problem persists, call Beckman Coulter Field Service.
A800 - Alert: Door Latch	Door latch will not engage	<ol style="list-style-type: none"> 1. Make sure the door is closed before pressing Start. 2. If the problem persists, call Beckman Coulter Field Service.
A802 - Alert: Door Latch	Door latch changed states	Call Beckman Coulter Field Service.
D803 - Door Latch	Door latch will not disengage	Call Beckman Coulter Field Service.

Diagnostics

Diagnostics/User Messages Chart

Third Party Contributions and Legal Notices

Software accompanying this ultracentrifuge contains Beckman Coulter Inc.'s works ("Beckman Works") and modified or unmodified binary form of third party contributions ("Third Party Works"). Rights to only the Third Party Works are offered or granted to downstream software recipients and developers, under their respective licenses, as provided below. The licenses provided below do not apply to any portion of Beckman Works. All intellectual property rights in and to Beckman Works (including but not limited to copyright in and to Beckman Works, any derivative work based on part or all of Beckman Works, and images, photographs, text, and other information that may be incorporated in Beckman Works), are owned and reserved by Beckman Coulter, Inc.

A. AdornedControl, available at <http://www.codeproject.com/KB/WPF/adornedcontrol.aspx>, by Ashley Davis, the standard version included in its binary form linked with other modules. This work is made available under the Code Project Open License 1.02 ("CPOL"), available at <http://www.codeproject.com/info/cpol10.aspx>. By exercising any rights to **AdornedControl**, the recipient accepts and agrees to be bound by the terms of CPOL.

B. PasswordAssistant, available at <http://blog.functionalfun.net/2008/06/wpf-passwordbox-and-data-binding.html>. and **ListBoxSelectedItemBinding**, available at <http://blog.functionalfun.net/2009/02/how-to-databind-to-selecteditems.html>, both by Samuel Jack. These works are made available under the Creative Commons Attribution 2.0 England and Wales License, available at <http://creativecommons.org/licenses/by/2.0/uk/>.

C. BalancedWrapPanel, Copyright Microsoft Corporation, available at <http://blogs.msdn.com/b/delay/archive/2009/12/13/wrap-music-a-more-flexible-balanced-wrappanel-implementation-for-silverlight-and-wpf.aspx>, by David Anson; **MvvmFoundation.WPF**, available at <http://mvvmfoundation.codeplex.com/SourceControl/list/changesets#>, by Josh Smith; and modified portions of **MvvmFoundation.WPF**, contained in **MvvmFoundatiopn.MH-Changes.zip**, available at <http://mvvmfoundation.codeplex.com/workitem/5453>, by Matt Heffron. These works are made available under the following license:

Microsoft Public License (Ms-PL)

This license governs use of the accompanying software. If you use the software, you accept this license. If you do not accept the license, do not use the software.

1. Definitions

The terms "reproduce," "reproductions," "derivative works," and "distribution" have the same meaning here as under U.S. copyright law.

A "contribution" is the original software, or any additions or changes to the software.

A "contributor" is any person that distributes its contribution under this license.

“Licensed patents” are a contributor’s patent claims that read directly on its contribution.

2. Grant of Rights

- a. Copyright Grant--Subject to the terms of this license, including the license conditions and limitations in section 3, each contributor grants you a non-exclusive, worldwide, royalty-free copyright license to reproduce its contribution, prepare derivative works of its contribution, and distribute its contribution or any derivative works that you create.
- b. Patent Grant--Subject to the terms of this license, including the license conditions and limitations on patents to make, have made, use, sell, offer for sale, import, and/or otherwise dispose of its contribution in the software or derivative works of the contribution in the software.

3. Conditions and Limitations

- a. No Trademark License--This license does not grant you rights to use any contributors’ name, logo, or trademarks.
- b. If you bring a patent claim against any contributor over patents that you claim are infringed by the software, your patent license from such contributor to the software ends automatically.
- c. If you distribute any portion of the software, you must retain all copyright, patent, trademark, and attribution notices that are present in the software.
- d. If you distribute any portion of the software in source code form, you may do so only under this license by including a complete copy of this license with your distribution. If you distribute any portion of the software in compiled or object code form, you may only do so under a license that complies with this license.
- e. The software is licensed “as-is”. You bear the risk of using it. The contributors give no express warranties, guarantees, or conditions. You may have additional consumer rights under your local laws which this license cannot change. To the extent permitted under your local laws, the contributors exclude the implied warranties of merchantability, fitness for a particular purpose and non-infringement.

D. VNC Free Edition 4.1.3, Copyright 2002-2008 RealVNC Limited, is included in its unmodified binary form as aggregate work. A copy of this work in source form may be obtained at no cost by contacting Beckman Coulter Technical Support. This work is made available under the following license:

GNU GENERAL PUBLIC LICENSE

Version 3, 29 June 2007

Copyright 2007 Free Software Foundation, Inc. <<http://fsf.org/>>

Everyone is permitted to copy and distribute verbatim copies of this license document, but changing it is not allowed.

Preamble

The GNU General Public License is a free, copyleft license for software and other kinds of works.

The licenses for most software and other practical works are designed to take away your freedom to share and change the works. By contrast, the GNU General Public License is intended to guarantee your freedom to share and change all versions of a program--to make sure it remains free software for all its users. We, the Free Software Foundation, use the GNU General Public License for most of

our software; it applies also to any other work released this way by its authors. You can apply it to your programs, too.

When we speak of free software, we are referring to freedom, not price. Our General Public Licenses are designed to make sure that you have the freedom to distribute copies of free software (and charge for them if you wish), that you receive source code or can get it if you want it, that you can change the software or use pieces of it in new free programs, and that you know you can do these things.

To protect your rights, we need to prevent others from denying you these rights or asking you to surrender the rights. Therefore, you have certain responsibilities if you distribute copies of the software, or if you modify it: responsibilities to respect the freedom of others.

For example, if you distribute copies of such a program, whether gratis or for a fee, you must pass on to the recipients the same freedoms that you received. You must make sure that they, too, receive or can get the source code. And you must show them these terms so they know their rights.

Developers that use the GNU GPL protect your rights with two steps: (1) assert copyright on the software, and (2) offer you this License giving you legal permission to copy, distribute and/or modify it.

For the developers' and authors' protection, the GPL clearly explains that there is no warranty for this free software. For both users' and authors' sake, the GPL requires that modified versions be marked as changed, so that their problems will not be attributed erroneously to authors of previous versions.

Some devices are designed to deny users access to install or run modified versions of the software inside them, although the manufacturer can do so. This is fundamentally incompatible with the aim of protecting users' freedom to change the software. The systematic pattern of such abuse occurs in the area of products for individuals to use, which is precisely where it is most unacceptable. Therefore, we have designed this version of the GPL to prohibit the practice for those products. If such problems arise substantially in other domains, we stand ready to extend this provision to those domains in future versions of the GPL, as needed to protect the freedom of users.

Finally, every program is threatened constantly by software patents. States should not allow patents to restrict development and use of software on general-purpose computers, but in those that do, we wish to avoid the special danger that patents applied to a free program could make it effectively proprietary. To prevent this, the GPL assures that patents cannot be used to render the program non-free.

The precise terms and conditions for copying, distribution and modification follow.

TERMS AND CONDITIONS

0. Definitions

“This License” refers to version 3 of the GNU General Public License.

“Copyright” also means copyright-like laws that apply to other kinds of works, such as semiconductor masks.

“The Program” refers to any copyrightable work licensed under this License. Each licensee is addressed as “you”. “Licensees” and “recipients” may be individuals or organizations.

To “modify” a work means to copy from or adapt all or part of the work in a fashion requiring copyright permission, other than the making of an exact copy. The resulting work is called a “modified version” of the earlier work or a work “based on” the earlier work.

A “covered work” means either the unmodified Program or a work based on the Program.

To “propagate” a work means to do anything with it that, without permission, would make you directly or secondarily liable for infringement under applicable copyright law, except executing it on a computer or modifying a private copy. Propagation includes copying, distribution (with or without modification), making available to the public, and in some countries other activities as well.

To “convey” a work means any kind of propagation that enables other parties to make or receive copies. Mere interaction with a user through a computer network, with no transfer of a copy, is not conveying.

An interactive user interface displays “Appropriate Legal Notices” to the extent that it includes a convenient and prominently visible feature that (1) displays an appropriate copyright notice, and (2) tells the user that there is no warranty for the work (except to the extent that warranties are provided), that licensees may convey the work under this License, and how to view a copy of this License. If the interface presents a list of user commands or options, such as a menu, a prominent item in the list meets this criteria.

1. Source Code

The “source code” for a work means the preferred form of the work for making modifications to it. “Object code” means any non-source form of a work.

A “Standard Interface” means an interface that either is an official standard defined by a recognized standards body, or, in the case of interfaces specified for a particular programming language, one that is widely used among developers working in that language.

The “System Libraries” of an executable work include anything, other than the work as a whole, that (a) is included in the normal form of packaging a Major Component, but which is not part of the Major Component, and (b) serves only to enable use of the work with that Major Component, or to implement a Standard Interface for which an implementation is available to the public in source code form. A “Major Component”, in this context, means a major essential component (kernel, window system, and so on) of the specific operating system (if any) on which the executable work runs, or a compiler used to produce the work, or an object code interpreter used to run it.

The “Corresponding Source” for a work in object code form means all the source code needed to generate, install, and (for an executable work) run the object code and to modify the work, including scripts to control those activities. However, it does not include the work’s System Libraries, or general-purpose tools or generally available free programs which are used unmodified in performing those activities but which are not part of the work. For example, Corresponding Source includes interface definition files associated with source files for the work, and the source code for shared libraries and dynamically linked subprograms that the work is specifically designed to require, such as by intimate data communication or control flow between those subprograms and other parts of the work.

The Corresponding Source need not include anything that users can regenerate automatically from other parts of the Corresponding Source.

The Corresponding Source for a work in source code form is that same work.

2. Basic Permissions

All rights granted under this License are granted for the term of copyright on the Program, and are irrevocable provided the stated conditions are met. This License explicitly affirms your unlimited permission to run the unmodified Program. The output from running a covered work is covered by this License only if the output, given its content, constitutes a covered work. This license acknowledges your rights of fair use or other equivalent, as provided by copyright law.

You may make, run, and propagate covered works that you do not convey, without conditions so long as your license otherwise remains in force. You may convey covered works to others for the sole purpose of having them make modifications exclusively for you, or provide you with facilities for running those works, provided that you comply with the terms of this License in conveying all material for which you do not control copyright. Those thus making or running the covered works for you must do so exclusively on your behalf, under your direction and control, on terms that prohibit them from making any copies of your copyrighted material outside their relationship with you.

Conveying under any other circumstances is permitted solely under the conditions stated below. Sublicensing is not allowed, section 10 makes it unnecessary.

3. Protecting Users' Legal Rights From Anti-Circumvention Law

No covered work shall be deemed part of an effective technological measure under any applicable law fulfilling obligations under article 11 of the WIPO copyright treaty adopted on 20 December 1996, or similar laws prohibiting or restricting circumvention of such measures.

When you convey a covered work, you waive any legal power to forbid circumvention of technological measures to the extent such circumvention is effected by exercising rights under this License with respect to the covered work, and you disclaim any intention to limit operation or modification of the work as a means of enforcing, against the work's users, your or third parties' legal rights to forbid circumvention of technological measures.

4. Conveying Verbatim Copies

You may convey verbatim copies of the Program's source code as you receive it, in any medium, provided that you conspicuously and appropriately publish on each copy an appropriate copyright notice; keep intact all notices stating that this License and any non-permissive terms added in accord with section 7 apply to the code; keep intact all notices of the absence of any warranty; and give all recipients a copy of this License along with the Program.

You may charge any price or no price for each copy that you convey, and you may offer support or warranty protection for a fee.

5. Conveying Modified Source Versions

You may convey a work based on the Program, or the modifications to produce it from the Program, in the form of source code under the terms of section 4, provided that you also meet all of these conditions:

- a) The work must carry prominent notices stating that you modified it, and giving a relevant date.
- b) The work must carry prominent notices stating that it is released under this License and any conditions added under section 7. This requirement modifies the requirement in section 4 to "keep intact all notices".
- c) You must license the entire work, as a whole, under this License to anyone who comes into possession of a copy. This License will therefore apply, along with any applicable section 7 additional terms, to the whole of the work and all its parts, regardless of how they are packaged.

This License gives no permission to license the work in any other way, but it does not invalidate such permission if you have separately received it.

- d) If the work has interactive user interfaces, each must display Appropriate Legal Notices; however, if the Program has interactive interfaces that do not display Appropriate Legal Notices, your work need not make them do so.

A compilation of a covered work with other separate and independent works, which are not by their nature extensions of the covered work, and which are not combined with it such as to form a larger program, in or on a volume of a storage or distribution medium, is called an “aggregate” if the compilation and its resulting copyright are not used to limit the access or legal rights of the compilation’s users beyond which the individual works permit. Inclusion of a covered work in an aggregate does not cause the License to apply to the other parts of the aggregate.

6. Conveying Non-Source Forms.

You may convey a covered work in object code form under the terms of sections 4 and 5, provided that you also convey the machine-readable Corresponding Source under the terms of this License, in one of these ways:

- a) Convey the object code in, or embodied in, a physical product (including a physical distribution medium), accompanied by the Corresponding Source fixed on a durable physical medium customarily used for software interchange.
- b) Convey the object code in, or embodied in, a physical product (including a physical distribution medium), accompanied by a written offer, valid for at least three years and valid for as long as you offer spare parts or customer support for that product model, to give anyone who possesses the object code either (1) a copy of the Corresponding Source for all the software in the product that is covered by this License, on a durable physical medium customarily used for software interchange, for a price no more than your reasonable cost of physically performing this conveying of source, or (2) access to copy the Corresponding Source from a network server at no charge.
- c) Convey individual copies of the object code with a copy of the written offer to provide the Corresponding Source. This alternative is allowed only occasionally and noncommercially, and only if you received the object code with such an offer in accord with subsection 6b.
- d) Convey the object code by offering access from a designated place (gratis or for a charge), and offer equivalent access to the Corresponding Source in the same way through the same place at no further charge. You need not require recipients to copy the Corresponding Source along with the object code. If the place to copy the object code is a network server, the Corresponding Source may be on a different server (operated by you or a third party) that supports equivalent copying facilities, provided you maintain clear directions next to the object code saying where to find the Corresponding Source. Regardless of what server hosts the Corresponding Source, you remain obligated to ensure that it is available for as long as needed to satisfy these requirements.
- E) Convey the object code using peer-to-peer transmission, provided you inform other peers where the object code and Corresponding Source of the work are being offered to the general public at no charge under subsection 6d.

A separable portion of the object code, whose source code is excluded from the Corresponding Source as a System Library, need not be included in conveying the object code work.

A “User Product” is either (1) a “consumer product”, which means any tangible personal property which is normally used for personal, family, or household purposes, or (2) anything designed or sold for incorporation into a dwelling. In determining whether a product is a consumer product, doubtful cases shall be resolved in favor of coverage. For a particular product received by a particular user, “normally used” refers to a typical or common use of that class of product, regardless of the status of the particular user or of the way in which the particular user actually uses, or expects or is expected to use, the product. A product is a consumer product regardless of whether the product has substantial commercial, industrial or non-consumer uses, unless such uses represent the only significant mode of use of the product.

“Installation Information” for a User Product means any methods, procedures, authorization keys, or other information required to install and execute modified versions of a covered work in that User Product from a modified version of its Corresponding Source. The information must suffice to ensure that the continued functioning of the modified object code is in no case prevented or interfered with solely because modification has been made.

If you convey an object code work under this section in, or with, or specifically for use in, a User Product, and the conveying occurs as part of a transaction in which the right of possession and use of the User Product is transferred to the recipient in perpetuity or for a fixed term (regardless of how the transaction is characterized), the Corresponding Source conveyed under the section must be accompanied by the Installation Information. But this requirement does not apply if neither you nor any third party retains the ability to install modified object code on the User Product (for example, the work has been installed in ROM). The requirement to provide Installation Information does not include a requirement to continue to provide support service, warranty, or updates for a work that has been modified or installed by the recipient, or for the User Product in which it has been modified or installed. Access to a network may be denied when the modification itself materially and adversely affects the operation of the network or violates the rules and protocols for communication across the network.

Corresponding Source conveyed, and Installation Information provided, in accord with this section must be in a format that is publicly documented (and with the implementation available to the public in source code form), and must require no special password or key for unpacking, reading or copying.

7. Additional Terms.

“Additional permissions” are terms that supplement the terms of this license by making exceptions from one or more of its conditions. Additional permissions that are applicable to the entire Program shall be treated as though they were included in this License, to the extent that they are valid under applicable law. If additional permissions apply only to part of the Program, that part may be used separately under those permissions, but the entire Program remains governed by this License without regard to the additional permissions.

When you convey a copy of a covered work, you may at your option remove any additional permissions from that copy, or from any part of it. (Additional permissions may be written to require their own removal in certain cases when you modify the work.) You may place additional permissions on material, added by you to a covered work, for which you have or can give, appropriate copyright permission.

Notwithstanding any other provisions of this License, for material you add to a covered work, you may (if authorized by the copyright holders of that material) supplement the terms of this License with terms:

- a) Disclaiming warranty or limiting liability differently from the terms of sections 15 and 16 of this License; or
- b) Requiring preservation of specified reasonable legal notices or author attribution in that material or in the Appropriate Legal Notices displayed by works containing it; or
- c) Prohibiting misrepresentation of the origin of that material, or requiring that modified versions of such material be marked in reasonable ways as different from the original version; or
- d) Limiting the use for publicity purposes of names of licensors or authors of the material; or
- e) Declining to grant rights under trademark law for use of some trade names, trademarks, or service marks; or
- f) Requiring indemnification of licensors and authors of that material by anyone who conveys the material (or modified versions of it) with contractual assumptions of liability to the recipient, for any liability that these contractual assumptions directly impose on those licensors and authors.

All other non-permissive additional terms are considered “further restrictions” within the meaning of section 10. If the Program as you received it, or any part of it, contains a notice stating that it is governed by the License along with a term that is a further restriction, you may remove that term. If a license document contains a further restriction but permits relicensing or conveying under this License, you may add to a covered work material governed by the terms of that license document, provided that the further restriction does not survive such relicensing or conveying.

If you add terms to a covered work in accord with this section, you must place, in the relevant source files, a statement of the additional terms that apply to those files, or a notice indicating where to find the applicable terms.

Additional terms, permissive or non-permissive, may be stated in the form of a separately written license, or stated as exceptions; the above requirements apply either way.

8. Termination.

You may not propagate or modify a covered work except as expressly provided under this License. any attempt otherwise to propagate or modify it is void, and will automatically terminate your rights under this License (including any patent licenses granted under the third paragraph of section 11).

However, if you cease all violation of this License, then your license from a particular copyright holder is reinstated (a) provisionally, unless and until the copyright holder explicitly and finally terminates your license, and (b) permanently, if the copyright holder fails to notify you of the violation by some reasonable means prior to 60 days after the cessation.

Moreover, your license from a particular copyright holder is reinstated permanently if the copyright holder notifies you of the violation by some reasonable means, this is the first time you have received notice of violation of this License (for any work) from that copyright holder, and you cure the violation prior to 30 days after your receipt of the notice.

Termination of your rights under this section does not terminate the licenses of parties who have received copies or rights from you under this License. If your rights have been terminated and not

permanently reinstated, you do not qualify to receive new licenses for the same material under section 10.

9. Acceptance Not Required for Having Copies.

You are not required to accept this License in order to receive or run a copy of the Program. Ancillary propagation of a covered work occurring solely as a consequence of using peer-to-peer transmission to receive a copy likewise does not require acceptance. However, nothing other than this License grants you permission to propagate or modify any covered work. These actions infringe copyright if you do not accept this License. Therefore, by modifying or propagating a covered work, you indicate your acceptance of this License to do so.

10. Automatic Licensing of Downstream Recipients.

Each time you convey a covered work, the recipient automatically receives a license from the original licensors, to run, modify and propagate that work, subject to this License. You are not responsible for enforcing compliance by third parties with this License.

An “entity transaction” is a transaction transferring control of an organization, or substantially all assets of one, or subdividing an organization, or merging organizations. If propagation of a covered work results from an entity transaction, each party to that transaction who receives a copy of the work also receives whatever licenses to the work the party’s predecessor in interest had or could give under the previous paragraph, plus a right to possession of the Corresponding Source of the work from the predecessor in interest, if the predecessor has it or can get it with reasonable efforts. You may not impose any further restrictions on the exercise of the rights granted or affirmed under this License. For example, you may not impose a license fee, royalty, or other charge for exercise of rights granted under this License, and you may not initiate litigation (including a cross-claim or counterclaim in a lawsuit) alleging that any patent claim is infringed by making, using, selling, offering for sale, or importing the Program or any portion of it.

11. Patents.

A “contributor” is a copyright holder who authorizes use under this License of the Program or a work on which the Program is based. The work thus licensed is called the contributor’s “contributor version”.

A contributor’s “essential patent claims” are all patent claims owned or controlled by the contributor, whether already acquired or hereafter acquired, that would be infringed by some manner, permitted by this License, of making, using, or selling its contributor version, but do not include claims that would be infringed only as a consequence of further modification of the contributor version. For purposes of this definition, “control” includes the right to grant patent sublicenses in a manner consistent with the requirements of the License.

Each contributor grants you a non-exclusive, worldwide, royalty-free patent license under the contributor’s essential patent claims, to make, use, sell, offer for sale, import and otherwise run, modify and propagate the contents of its contributor version.

In the following three paragraphs, a “patent license” is any express agreement or commitment, however denominated, not to enforce a patent (such as an express permission to practice a patent or covenant not to sue for patent infringement). To “grant” such a patent license to a party means to make such an agreement or commitment not to enforce a patent against the party.

If you convey a covered work, knowingly relying on a patent license, and the Corresponding Source of the work is not available for anyone to copy, free of charge and under the terms of this License, through a publicly available network server or other readily accessible means, then you must either (1) cause the Corresponding Source to be so available, or (2) arrange to deprive yourself of the benefit of the patent license for this particular work, or (3) arrange, in a manner consistent with the

requirements of this License, to extend the patent license to downstream recipients. “Knowingly relying” means you have actual knowledge that, but for the patent license, your conveying the covered work in a country, or your recipient’s use of the covered work in a country, would infringe one or more identifiable patents in that country that you have reason to believe are valid.

If, pursuant to or in connection with a single transaction arrangement, you convey, or propagate by procuring conveyance of, a covered work, and grant a patent license to some of the parties receiving the covered work authorizing them to use, propagate, modify or convey a specific copy of the covered work, then the patent license you grant is automatically extended to all recipients of the covered work and works based on it.

A patent license is “discriminatory” if it does not include within the scope of its coverage, prohibits the exercise of, or is conditioned on the non-exercise of one or more of the rights that are specifically granted under this License. You may not convey a covered work if you are a party to an arrangement with a third party that is in the business of distributing software, under which you make payment to the third party based on the extent of your activity of conveying the work, and under which the third party grants, to any of the parties who would receive the covered work from you, a discriminatory patent license (a) in connection with copies of the covered work conveyed by you (or copies made from those copies), or (b) primarily for and in connection with specific products or compilations that contain the covered work, unless you entered into that arrangement, or that patent license was granted, prior to 28 March 2007.

Nothing in this license shall be construed as excluding or limiting any implied license or other defenses to infringement that may otherwise be available to you under applicable patent law.

12. No Surrender of Others’ Freedom.

If conditions are imposed on you (whether by court order, agreement or otherwise) that contradict the conditions of this License, they do not excuse you from the conditions of this License. If you cannot convey a covered work so as to satisfy simultaneously your obligations under this License and any other pertinent obligations, then as a consequence you may not convey it at all. For example, if you agree to terms that obligate you to collect a royalty for further conveying from those to whom you convey the Program, the only way you could satisfy both those terms and this License would be to refrain entirely from conveying the Program.

13. Use with the GNU Affero General Public License.

Notwithstanding any other provision of this License, you have permission to link or combine any covered work with a work license under version 3 of the GNU Affero General Public License into a single combined work, and to convey the resulting work. The terms of this License will continue to apply to the part which is the covered work, but the special requirements of the GNU Affero General Public License, section 13, concerning interaction through a network will apply to the combination as such.

14. Revised Versions of this License.

The Free Software Foundation may publish revised and/or new versions of the GNU General Public License from time to time. Such new versions will be similar in spirit to the present version, but may differ in detail to address new problems or concerns.

Each version is given a distinguishing version number. If the Program specifies that a certain numbered version of the GNU General Public License “or any later version” applies to it, you have the option of following the terms and conditions either of that numbered version or of any later version published by the Free Software Foundation. If the Program does not specify a version number of the GNU General Public License, you may choose any version ever published by the Free Software Foundation.

If the Program specifies that a proxy can decide which future versions of the GNU General Public License can be used, that proxy's public statement of acceptance of a version permanently authorizes you to choose that version for the Program.

Later license versions may give you additional or different permissions. However, no additional obligations are imposed on any author or copyright holder as a result of your choosing to follow a later version.

15. Disclaimer of Warranty.

THERE IS NO WARRANTY FOR THE PROGRAM, TO THE EXTENT PERMITTED BY APPLICABLE LAW. EXCEPT WHEN OTHERWISE STATED IN WRITING THE COPYRIGHT HOLDERS AND/OR OTHER PARTIES PROVIDE THE PROGRAM "AS IS" WITHOUT WARRANTY OF ANY KIND, EITHER EXPRESSED OR IMPLIED, INCLUDING, BUT NOT LIMITED TO, THE IMPLIED WARRANTIES OF MERCHANTABILITY AND FITNESS FOR A PARTICULAR PURPOSE. THE ENTIRE RISK AS TO THE QUALITY AND PERFORMANCE OF THE PROGRAM IS WITH YOU. SHOULD THE PROGRAM PROVE DEFECTIVE, YOU ASSUME THE COST OF ALL NECESSARY SERVICING, REPAIR OR CORRECTION.

16. Limitation of Liability.

IN NO EVENT UNLESS REQUIRED BY APPLICABLE LAW OR AGREED TO IN WRITING WILL ANY COPYRIGHT HOLDER, OR ANY OTHER PARTY WHO MODIFIES AND/OR CONVEYS THE PROGRAM AS PERMITTED ABOVE, BE LIABLE TO YOU FOR DAMAGES, INCLUDING ANY GENERAL, SPECIAL, INCIDENTAL OR CONSEQUENTIAL DAMAGES ARISING OUT OF THE USE OR INABILITY TO USE THE PROGRAM (INCLUDING BUT NOT LIMITED TO LOSS OF DATA OR DATA BEING RENDERED INACCURATE OR LOSSES SUSTAINED BY YOU OR THIRD PARTIES OR A FAILURE OF THE PROGRAM TO OPERATE WITH ANY OTHER PROGRAMS), EVEN IF SUCH HOLDER OR OTHER PARTY HAS BEEN ADVISED OF THE POSSIBILITY OF SUCH DAMAGES.

17. Interpretation of Sections 15 and 16.

If the disclaimer of warranty and limitation of liability provided above cannot be given local legal effect according to their terms, reviewing courts shall apply local law that most closely approximates an absolute waiver of all civil liability in connection with the Program, unless a warranty or assumption of liability accompanies a copy of the Program in return for a fee.

END OF TERMS AND CONDITIONS

www.beckmancoulter.com

