H.264 NETWORK Embedded DVR

USER MANUAL





CAUTION

RISK OF ELECTRIC SHOCK
DO NOT OPEN



CAUTION: TO REDUCE THE RISK OF ELECTRIC SHOCK DO NOT REMOVE COVER. NO USER SERVICABLE PARTS INSIDE.

REFER SERVICING TO QUALIFIED SERVICE PERSONNEL.



The lightning flash with arrowhead symbol, within an equilateral triangle, is intended to alert the user to the presence of uninsulated "dangerous voltage" within the products' enclosure that may be of sufficient magnitude to constitute a risk of electric shock.



The exclamation point within an equilateral triangle is intended to alert the user to the presence of important operating and maintenance (servicing) instructions in the literature accompanying the appliance.

WARNING: TO PREVENT FIRE OR SHOCK HAZARD, DO NOT EXPOSE THIS UNIT TO RAIN OR MOISTURE.

CAUTION: TO PREVENT ELECTRIC SHOCK, MATCH WIDE BLADE OF THE PLUG TO THE WIDE SLOT AND FULLY INSERT.



CONTENT

1.1	PRODUCT INTRODUCTION.....	4
1.2	PRODUCT FEATURE.....	4
1.2.1	SPECIFICATION.....	4
1.2.2	BASIC WORKING PARAMETER.....	6
1.3	ENVIRONMENT ADAPTABILITY.....	6
2	DEVICE OPERATION.....	7
2.1	REMOTE KEY INSTRUCTION.....	7
2.1.1	REMOTE CONTROL.....	7
2.1.2	MOUSE OPERATION.....	8
2.1.3	MENU TREE.....	9
2.2	SYSTEM OPERATION.....	10
2.2.1	USER LOGIN.....	10
2.2.2	USING THE MAIN MENU.....	11
2.2.3	DEVICES MANAGEMENT.....	19
2.2.4	SYSTEM SETUP.....	26
3	IE OPERATION.....	31
3.1	FEATURE.....	31
3.2	USING REMOTE SURVEILLANCE.....	32
3.3	REMOTE SURVEILLANCE MAIN SCREEN.....	33
3.4	LIVE VIEWING.....	34
3.5	RECORDING.....	34
3.5.1	SUB-MENU.....	34
3.5.2	PTZ CONTROL.....	35
3.5.3	SCREEN CAPTURES.....	35
3.5.4	PLAYBACK.....	36
3.6	REMOTE SETUP.....	38
3.6.1	RECORD.....	38
3.6.2	ALARM SETTING.....	39
3.6.3	PTZ.....	40
3.6.4	NETWORK.....	40
3.6.5	SETTING.....	41
3.6.6	HOST INFO.....	42
4	DVR INSTALLATION.....	43
4.1	PRODUCT OVERVIEW.....	43
4.2	HDD INSTALLATION.....	46
5	FAQ.....	48

INTRODUCTION

1.1 PRODUCT INTRODUCTION

This product is a 16 channels CIF resolution Digital Video Recorder which has local recording, playback, support triple code remote network surveillance, data backup, parameter setting, motion detection, I/O alarm setting, PTZ, USB mouse, USB2.0 data backup, IE browser and back up.

1.2 PRODUCT FEATURE

- ◇ H.264 compression
- ◇ Two USB interface, USB2.0 for data backup, USB1.1 for mouse operation.
- ◇ Supports 2 pcs 3.5" SATA HDD
- ◇ Special file system for security
- ◇ 16 bit color translucent user-friendly GUI, with notes for selected menu items.
- ◇ Optimized one or four channel simultaneously playback
- ◇ Double level user management
- ◇ Supports live view, parameter setting and copy playback video via network.

1.2.1 SPECIFICATION

Item	Device	Performance index
System	Language	English /Chinese
	GUI	Graphic menu
	password	user password, administrator password
Video	Video in	16ch composite video input 1.0V p-p, impedance 75Ω, BNC
	Video out	2ch complex video output 1.0V p-p, impedance 75Ω, BNC
	Video display	1/4/9/16 switch
	Video standard	PAL, 25f/s, CCIR625line, 50scene NTSC, 30f/s, CCIR525line, 60scene
Audio	Audio input	16ch audio input, impedance 600Ω, RCA
	Audio output	1ch audio output, impedance 600Ω, RCA
	Basic electricity output	Linearity electricity
	Record style	Audio video recorded simultaneously
	Audio compression	ADPCM
Picture proceeding and store	Picture compression	H.264
	Resolution	CIF
	Streaming style	ISO14496-10

	Audio style	ADPCM
	Video code rate	CIF: 384Kbps ~ 768Kbps
	Audio code rate	32KB/s
	Data storage	Support mainstream SATA HDD
Alarm	Alarm input	16 alarm input
	Alarm output	1 alarm output
Connector	Serial interface	Support 1 RS232
	Serial interface	Support 1 RS485
	Network interface	RJ45,10M/100M
USB	Mouse	USB1.1
	Thumb drive	USB2.0
VGA	VGA	1 VGA (optional)
Software	PC playback	Playback video file
	Software upgrade	Support USB firmware upgrade
Others	Voltage input	AC:110~240V
	Voltage output	DC:19V@3A or 3.42A
	Power	16W without HDD
	Working temperature	-10----50℃

1.2.2 BASIC WORKING PARAMETER

Item	Parameter	Description
Voltage input	19V	DC 19V
Video impedance input	75Ω	75Ω each channel.
Video output	1Vp-p	1Vp-p CVBS signal
I/O	0—2V	Low voltage alarm
	5V-30v	High voltage alarm
RS232		Serial port, for extend use
RS485		Connects to PTZ, (Pelco-D,Pelco-P)
SATA HDD		2 SATA HDD with mainstream capacity

1.3 ENVIRONMENT ADAPTABILITY

For safety while using the DVR and to prolong device life, please pay attention to the following details:

- 1) When installing device, please comply with all the electric product safety criteria.
- 2) Power and ground:
 - ◆ Do not touch the power and DVR with a wet hand
 - ◆ Do not drop liquid on DVR
 - ◆ Do not put any object on DVR
 - ◆ Please use soft dry cloth to clean DVR; do not use chemical impregnant.
 - ◆ The Device will have voltage before startup if the power line is connected to power source.
 - ◆ Please unplug power line from power source if the Device is not intended to be used for a prolonged time.

2 DEVICE OPERATION

In device operation, the enter key on remote control has the same function as left click of the mouse.

2.1 REMOTE KEY INSTRUCTION

2.1.1 REMOTE CONTROL

The remote control is the secondary input device for navigating the system's interface.

To use the remote control:

1. **STANDBY**: Press to turn standby mode ON/OFF.
2. **LOGIN/LOCK**: If "Security" has been enabled in the Setup menu, press to open the user password login screen.

3. **Number/Channel buttons**: While in menus, press button 0~9 to enter values; during live view, press to view channel in full-screen.





4. : Press to switch between quad and split-screen displays.

5. **MENU**: Opens the main menu.

6. **PTZ**: Press to open the PTZ control window.

7. **EXIT**: Close menu windows.

8. **Navigation/OK**:

- /CH+: Move cursor in menus up; Channel Up.
- /FWD: Move cursor in menus right; during playback, increase forward playback speed (5X, 15X, 60X).
- /REW: Move cursor in menus left; during playback, increase reverse playback speed (5X, 15X, 60X)
- /CH-: Move cursor in menus down; Channel down.
- **OK**: In menus, press to confirm selections; during playback and preview, press to view system information.





9. **+/-**: In menus, press to adjust values.

10. **RECORD**: Press to start manual recording.

11. **STOP**: Press to stop manual recording.

12. **EXTRA**: For future use.

13. **Playback controls**:

- : Increase reverse playback speed 1X, 2X, 4X.
- : Press to start playback.
- : Press to increase forward playback speed 1X, 2X, 4X.
- : Press to slow playback speed by 1/2, 1/4, 1/8.
- : Press to freeze playback to one frame, then press again to advance frame-by-frame.

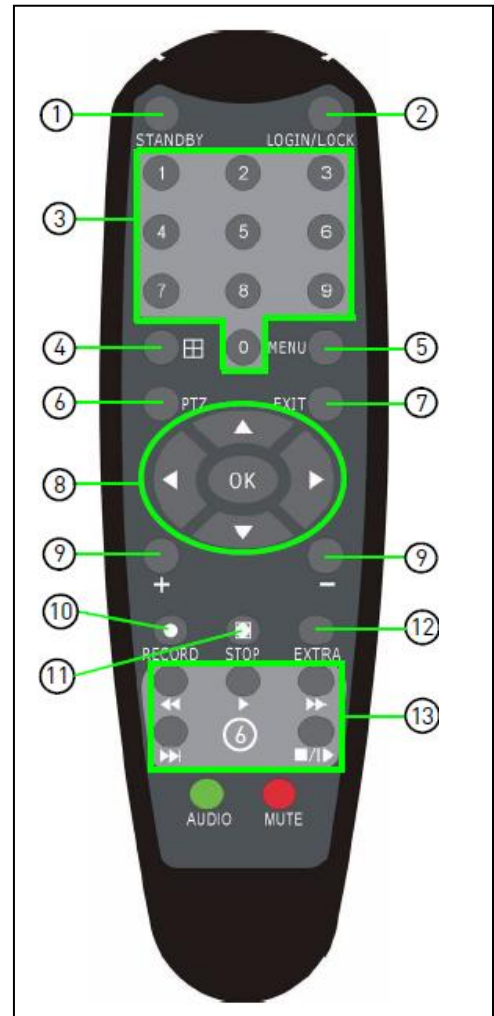

TIP: When using the remote control to enter password and camera titles, select the field using the navigation buttons, press ENTER, and then press the number buttons.

2.1.2 MOUSE OPERATION

The mouse is the primary input device for navigating system menus.

NOTE: Unless otherwise noted, all system functions described in this manual are achieved through mouse input.

To use a mouse with the system:

- 1) Connect a USB mouse to the **USB MOUSE port** on front panel of the system.

NOTE: Only the top USB port on the front panel is designed for data backup to a USB flash drive. Do not connect a USB flash drive to the bottom USB port on the rear panel.

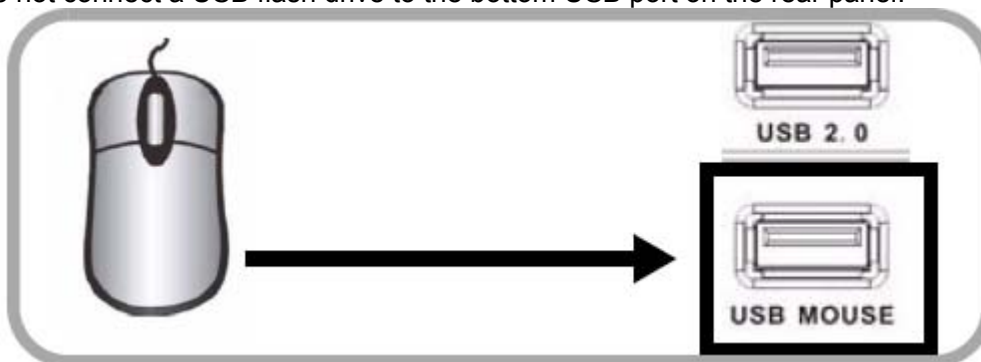

Figure 1.0 Connect a USB mouse to the bottom USB port on the front panel

- 2) Use the mouse buttons to perform the following:
 - **Left-Button:** Click to select a menu option; during live viewing in split-screen, double-click on a channel to view the selected channel in full-screen.; double-click the channel again to return to split-screen view
 - **Right-Button:** Click to open the Sub-Menu
- 3) **Scroll-Wheel:** No function.

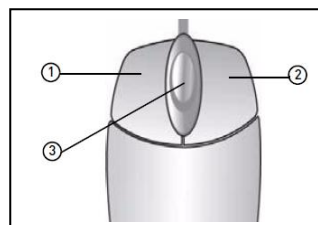
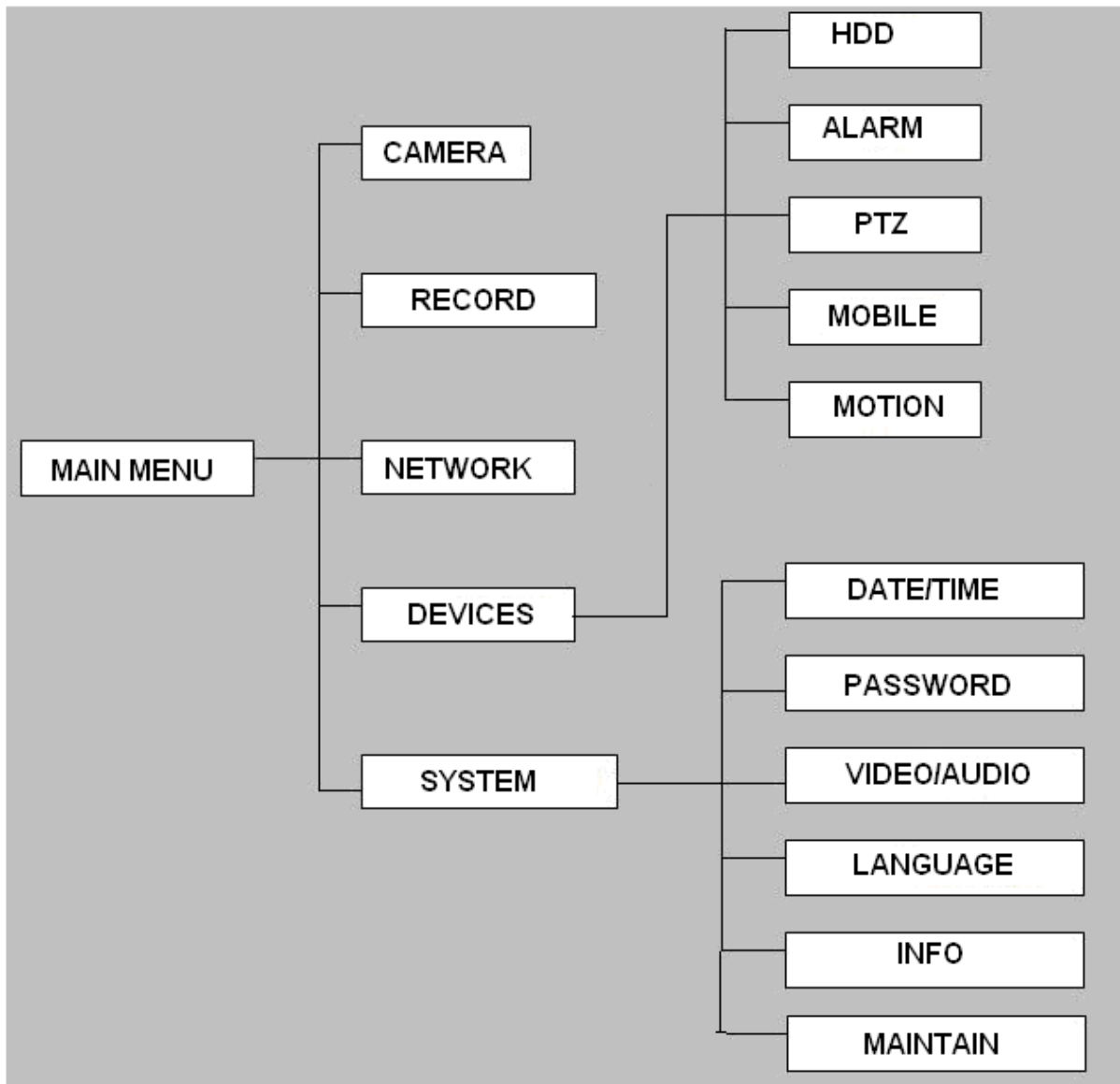

Figure 1.1 Mouse button operation

2.1.3 MENU TREE

You can control the DVR via menu operation. This tree will show you the menu structure and details will be shown in following chapters.



2.2 SYSTEM OPERATION

2.2.1 USER LOGIN

2.2.1.1 STARTING THE SYSTEM

To power the system ON/OFF:

Connect the power cable to the DC 19V port on the rear panel. At startup, the system performs a basic system check and runs an initial loading sequence. After a few moments, the system loads a live display view.

Standby Mode

The system can also be put into Standby Mode. Power will remain to the system but will not be recording.

To start/stop Standby mode:

- 1) Press and hold the **POWER** button on the front panel or remote control until the prompt closes. The system enters standby mode.
- 2) Press and hold the **POWER** button on the front panel or remote control until the system beeps. The system will begin powering up.

Password

ATTENTION: By default, passwords are **disabled** on the system. You do not need to enter a password when accessing any system menus. However, for security purposes, it is highly recommended to enable passwords on the system using the Password Menu.

NOTE:

- 1) If there is no HDD in device, or the device cannot read the HDD, or the HDD is not formatted it will display an **【H】** in the video preview interface.
- 2) You must format the HDD in the DVR before use. The steps are as follows: menu > HDD management > format. After formatting, the system will restart.

2.2.1.2 SYSTEM LOGIN

To open the Main Menu:

Right-click anywhere onscreen to open the Sub-Menu and select **MAIN MENU** (mouse only), or press the **LOGIN/LOCK** button on the remote control.

NOTE: If passwords are enabled on the system, you need to select your Device ID and enter the 6-digit numerical password to open the Main Menu.

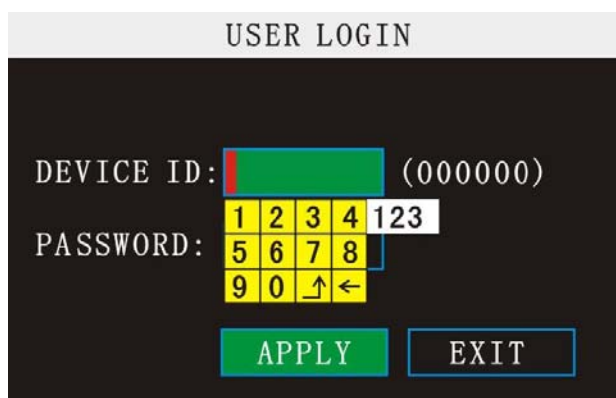

2.2.2 USING THE MAIN MENU



- 1) **CAMERA:** Configure video display settings.
- 2) **RECORD:** Configure recording parameters (quality, resolution), set record modes, and enable/disable audio recording.*
- 3) **NETWORK:** Use the Network Setup menu to configure your network and DDNS settings.
- 4) **SEARCH:** Search and playback recorded video on your system.
- 5) **DEVICES:** Opens the DEVICES Menu, which lets you setup the HDD, alarm, PTZ, mobile and motion detect.
- 6) **SYSTEM:** Opens the DEVICES Menu, which lets you setup the date/time, password, video/audio, language, info and maintain.
- 7) Displays information about the contents of the selected Main Menu icon.

*Audio capable cameras (not included) are required for audio recording on the system.

2.2.2.1 CAMERA

Use the Display Setup menu to customize channel titles, show/hide the date and time in live viewing and playback, and enable/disable preview channels.



To customize Display settings:

- 1) Configure the following options:
 - **TITLE:** Click any of the fields and enter a new title for the selected channel using the Virtual Keyboard (mouse only)
 - **POSITION:** Reposition the channel title; select U-L/D-L/U-R/D-R, or **OFF**. If OFF, the title will not be displayed for the selected channel
 - **COLOR:** Adjust **CHROMATICITY**, **LUMINOSITY**, **CONTRAST**, and **SATURATION** for the selected channel
 - **DISPLAY TIME WHILE IN LIVE VIEW:** Select **ON/OFF** to show/ hide the date and

time during live viewing

- **DISPLAY TIME WHILE RECORDING:** Select **ON/OFF** to show/hide the date and

time during playback.

- 2) Click **NEXT PAGE** to change the settings for the remaining channels.
- 3) Click **APPLY** to save your settings. Click **CLOSE** in the confirmation window.

LIVE

Live channels can be very useful if your display monitor is in public view. Select **OFF** of a preview channel will appear black on the display to give the impression that no cameras are connected and the system is not recording.

To enable/disable preview channels:

- 1) Choose a channel you wish to conceal. For example, channel 3. Under **PREVIEW**, select **OFF**.
- 2) Click **APPLY**. Channel 3 will turn black. Click **CLOSE** in the confirmation window.
- 3) Click **EXIT** in all menus until all windows are closed.

2.2.2.2 RECORD SETUP



Configure record parameters, enable/disable audio.

NOTE: Audio capable cameras (not included) are required for audio recording.

RECORD SETUP				
CH1~CH4	CH1	CH2	CH3	CH4
RECORD	ON	ON	ON	ON
QUALITY	GOOD	GOOD	GOOD	GOOD
AUDIO	ON			
REC. MODE	SCHEDULE	SCHEDULE		
PACK TIME	30MIN			
[DEFAULT] [APPLY] [EXIT]				

To configure recording options:

- 1) Under **RECORD**, use the drop-down menus and select **ON/OFF** to enable/disable recording from the selected channel.
- 3) Under **QUALITY**.
Select **GOOD**, **MID**, or **LOW**, Setup code rate for recording, corresponding to **384Kbps**, **512Kbps** and **768Kbps**.
- 2) Under **AUDIO**, select **ENABLE** or **DISABLE**. If audio recording is enabled, the system will record audio from connected audio capable cameras (not included).
- 3) Under **REC. MODE**, select **ALWAYS** or **SCHEDULE**. If you select **ALWAYS**, the system will record continuously (Normal Recording) when the system is powered on. If you select **SCHEDULE**, you have to set a recording schedule on the system.
- 4) Under **REC. SIZE**, select **15MIN**, **30MIN**, **45MIN**, or **60MIN**.
NOTE: Record Size sets the file size for recorded video files on the system. Instead of recording data as one large file, the system will divide the data into blocks of 15, 30, 45, or 60 minutes. This makes the recorded data easier to search.
- 5) Click **APPLY**. Click **CLOSE** in the confirmation window.

Click **EXIT** in every menu until all windows are closed.

Recording Schedule

By default, the system is set to record continuously. You can program the system to record according to a customized recording schedule.

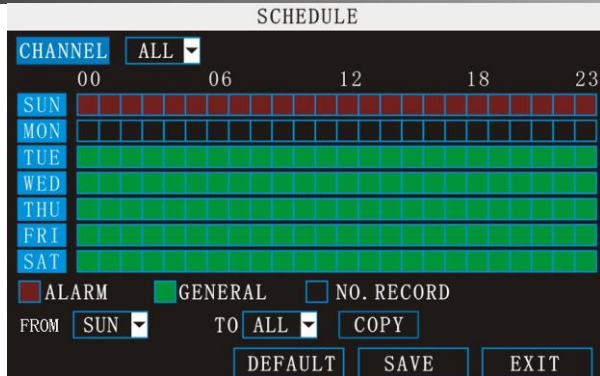

The Schedule Grid shows the days of the week and hours 0~23. You can set Alarm Recording (Red), General (Normal) Recording (Green), or No Recording (Blue) to each time block of each day.

To set a recording schedule:

- 1) Open the Main Menu and click **RECORD**.
- 2) Under REC. MODE, select **TIMER RECORD**.
- 3) Click **SCHEDULE**. The Schedule menu opens.
- 4) Under CHANNEL, select specific channels or select **ALL**.
- 5) Below the grid, click either **ALARM** (red), **GENERAL** (Green), or **NO RECORD** (Blue) and then click a time block on the desired day.
- 6) Use the **FROM/TO** drop-down menus to copy the schedule of one day to another.

For example, if you want your schedule for Monday to be the same on Wednesday: under FROM select **MON**, under TO select **WED**, and then click **COPY**.

- 7) Click **SAVE**.
- 8) Click **EXIT** in each menu until all windows are closed.

Example

You want your system to record continuously on all channels from 9 AM to 5 PM Monday to Friday. You also want Alarm/Motion recording from 5 PM to 9 AM. You do not want the system to record Saturday or Sunday.

NOTE: By default, the system is set to record continuously 24 hours a day, 7 days a week.

To set the recording schedule:

- 1) Open the Schedule menu.
- 2) Under CHANNEL, select **ALL**.
- 3) Click the **blue NO RECORD** block below the grid. A checkmark will appear in the block.
- 4) Under SUN, click blocks **00~23**. The blocks will turn blue.
- 5) Under FROM, select **SUN**. Under TO select **SAT**, and then click **COPY**.
- 6) Click the **red ALARM** block below the grid.
- 7) Under MON, click blocks **00~08** and blocks **18~23**. The blocks will turn red.
- 8) Under FROM, select **MON**. Under TO select **TUE**, and then click **COPY**. Repeat for Wednesday, Thursday, and Friday. Your completed schedule should be the same as the schedule in Figure 2.4.2.3.2.

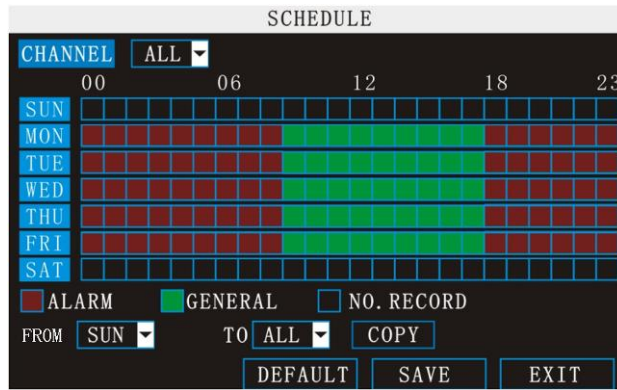

- 9) Click SAVE. Click CLOSE in the confirmation window.
- 10) Click EXIT in all menus until all windows are closed.

2.2.2.3 NETWORK SETUP

Use the Network Setup menu to configure your network and DNS settings.

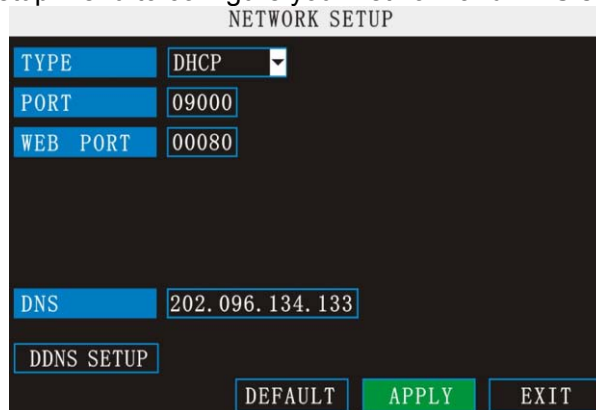

To configure network settings:

- 1) Under TYPE, select **DHCP**, **PPPoE**, or **STATIC**. If DHCP, go to step 5. If PPPoE, go to step 2. If STATIC, go to step 3.

NOTE: DHCP allows you to quickly connect to your network by obtaining an IP address from the router. After the initial setup, we recommend that you disable DHCP and set the IP address between 1~100. For example, if your IP address is 192.168.0.107, change the last digits to 90 (i.e. 192.163.0.90). This ensures that port forwarding will not change in the event of power failure or resetting of your network.

- 2) If you select PPPoE in step 1, enter your **PPPoE user name** and **password** in the respective fields using the Virtual Keyboard.

NETWORK SETUP	
TYPE	PPPOE
PORT	09000
WEB PORT	00080
PPPOE NAME	s*****@***.gd
PASSWORD	*****
DNS	202.096.134.133
DDNS SETUP	
[DEFAULT] [APPLY] [EXIT]	

- 3) If you selected STATIC in step 1, enter your **IP Address**, **Net mask**, and **Gateway** in the respective fields using the Virtual Keyboard.

NOTE: The default IP address of the system is 192.168.3.97

- 4) If necessary, change the Media and Web Ports.

NOTE: For added security, we strongly recommend changing Web port 80 on the system to any desired port not blocked by your Internet service provider (ISP). Please note however, that you will also need to update the Web port in your browser and open this new port in your router.

- 5) Click **APPLY**. Click **CLOSE** in the confirmation window.
6) Click **EXIT** in all menus until all windows are closed. The system restarts automatically.

Manual DNS

Enter the **Primary or Secondary DNS** from your router. This is required for DDNS to function properly.

To obtain your Primary or Secondary DNS:

- 1) In your web browser, log in to your router using its Default Gateway address.

NOTE: Refer to your router's manual or software for login information. You can also get the Default Gateway on your PC by selecting Start>Run. Type **CMD** and press **Enter**. In the Command Prompt window type **ipconfig** and press Enter.

- 2) View its **WAN settings**. Enter the **Primary or Secondary DNS** address in the **MANUAL DNS** field on your system.

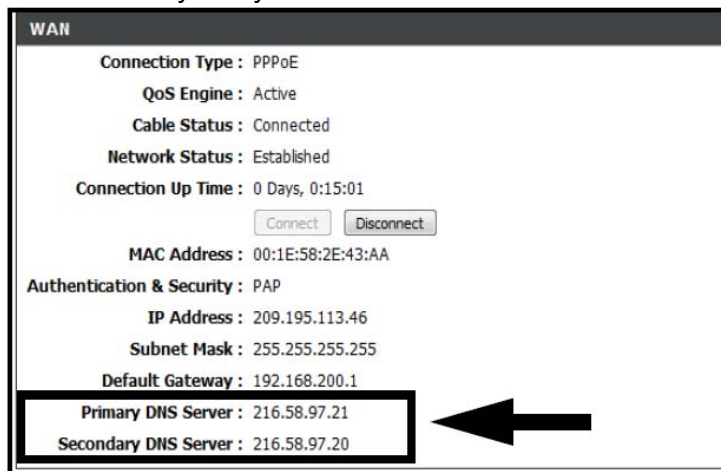

The screenshot shows the WAN settings page of a router. The page is titled "WAN" and contains the following information:

- Connection Type : PPPoE
- QoS Engine : Active
- Cable Status : Connected
- Network Status : Established
- Connection Up Time : 0 Days, 0:15:01
- Buttons: Connect, Disconnect
- MAC Address : 00:1E:58:2E:43:AA
- Authentication & Security : PAP
- IP Address : 209.195.113.46
- Subnet Mask : 255.255.255.255
- Default Gateway : 192.168.200.1
- Primary DNS Server : 216.58.97.21
- Secondary DNS Server : 216.58.97.20

A black arrow points to the Primary and Secondary DNS Server fields.

DDNS:

A DDNS account allows you to set up a web site address that points back to your Local Network.

NOTE: You must register DDNS service prior to configuring DDNS settings. Visit <https://www.dyndns.com> to register.

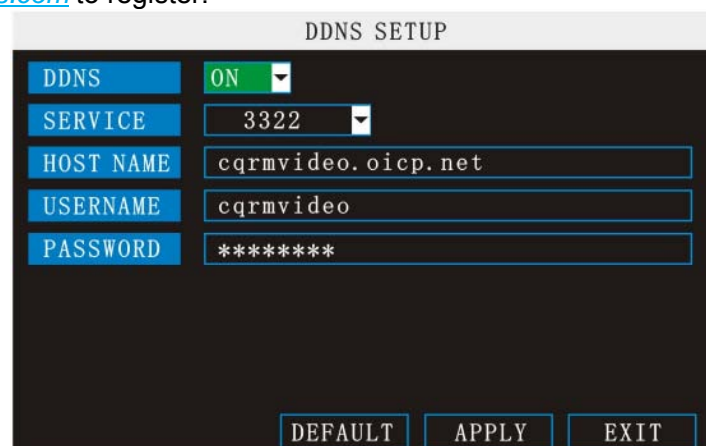

The screenshot shows the DDNS SETUP page of a router. The page is titled "DDNS SETUP" and contains the following information:

- DDNS: ON
- SERVICE: 3322
- HOST NAME: cqrmvideo.oicp.net
- USERNAME: cqrmvideo
- PASSWORD: *****
- Buttons: DEFAULT, APPLY, EXIT

To configure DDNS settings:

- 1) From the Network Setup menu, enter **Primary or Secondary DNS** from the WAN settings of your router in the **MANUAL DNS** field.
- 2) Click **DDNS SETTINGS**.
- 3) Under DDNS, select **ON**.
- 4) Under SERVICE, select Itsctv, dyndns or perfecteyes and so on.
- 5) Under DOMAIN NAME, enter **your DDNS domain** from the confirmation email.
For example, if your domain name is **adam@dyndns.com**, you need to enter

adam@dyndns.com, in the text field.

- 6) Enter your DDNS **user name** and **password** in the respective fields.
- 7) Click **APPLY**. Click **CLOSE** in the confirmation window.
- 8) Click **EXIT**. The system will prompt you that it must restart. Click **CLOSE**.

2.2.2.4 SEARCH



Search and playback recorded video on your system.



NOTE: When you first open the Search menu, it will display the current month and date.

To perform a Quick Search:

Open the Search menu and click **PLAY**. The last minute of recorded playback begins.

To perform a Date & Time search:

- 1) Under CHN, select individual channels or select ALL.
- 2) Under DATE, click the field and enter the desired date using the Virtual Keyboard and then click SEARCH. The system searches for date.
- 3) Under VIDEO STATE, the system shows recorded events in a Month Grid and a Time Grid. The selected day of the month will be outlined in red. Green=normal recording; Red=alarm recording (includes both alarm and motion events).
- 4) Click a date in the month grid to view recorded video files for that selected date in the hour grid.

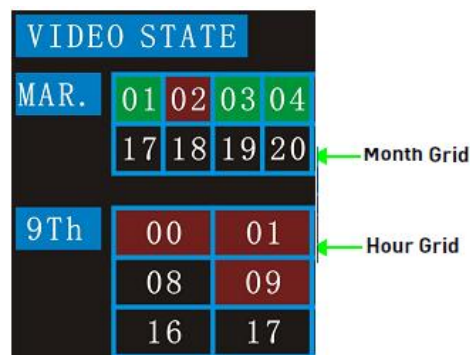

- 5) During playback, use the onscreen controls or the playback buttons on the remote control or front panel to control playback.

FILE LIST

Use the File List sub-menu to see a detailed list of all the recorded video on your system.

To open the File List:

- 1) From the Search Menu, click **SEARCH** to search the system for recorded video.
- 2) Click **FILE LIST** at the bottom of the menu. The File List menu opens.

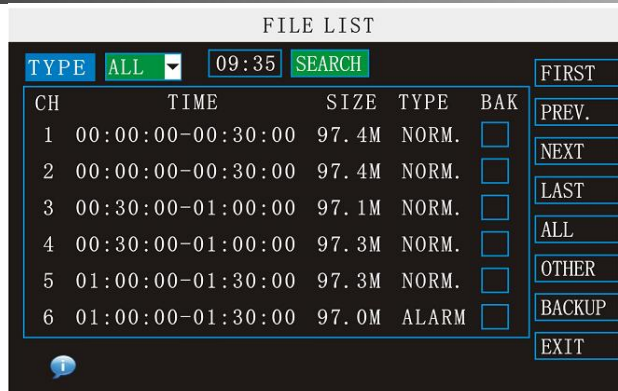

To use the File List:

- 1) Under TYPE, select **NORMAL** to view only normal recordings, **ALARM**, to view alarm recordings (includes alarm and motion detection), or **ALL** to view all video on your system.
- 2) Use the buttons on the side panel to navigate the file list:
 - **FIRST**: Jump to the first page of the list
 - **PREV.:** Turn to the previous page
 - **NEXT**: Turn to the next page
 - **LAST**: Jump to the last page of the list
 - **ALL**: Select all files
 - **OTHER**: Clear all files
 - **BACKUP**: After selecting a file(s), click to begin copying the data to a USB flash drive (not included);
- 3) Click any file to begin playback.
- 4) You can select up to 4 channels you want to playback.



BACKUP

Use the File List sub-menu to find recorded video on your system and copy it to a USB flash drive (not included).

NOTE: The system is compatible with most major brands of USB flash drives, with capacities from 256 MB to 4 GB.

To backup recorded data:

- 1) Connect a blank USB flash drive to the top USB port on the front panel of the system.
- 2) Open the Search menu and search for recorded data on the system.
- 3) Click **FILE LIST**.
- 4) Select the files you want to backup and click the "BAK" box next to the file name (see figure 0.0). Select multiple files if desired. Click **ALL** to select all files; click **OTHER** to deselect all files.

NOTE: The size of each file is shown in the File List menu. Use this to help you find a USB flash

drive
 large enough to hold all the files you wish to backup.

- 5) Click BACKUP from the side-panel to immediately begin copying the files to the USB flash drive.

NOTE: Backup progress appears in the status window. DO NOT remove the USB flash drive during backup.



Instruction:

- 1) When the space in backup device is less than recording file, the system will prompt "Space not enough"...

You can remove USB device directly when backup is finished

Instruction:

1. MONTH: It will show all the recording status in this month. Green means normal recording, Red means alarm recording, Grounding means no recording. Click any date in this frame to search the recording status of that day. The searching result will be showed in the date frame below.

2. DAY: It will show all the recording status in this day. You can playback the record file in this period by clicking the corresponding period.

PLAY: You can press **【Enter】** to input number directly to setup playback time. After setting, move the cursor to "PLAYBACK" and press "APPLY" to enter the video playback of that time. You can also select any period of time in the video status frame after searching; then press "APPLY" to enter the video playback of that period.

FILE LIST: Enter the video file list interface of the selected date.

LOG SEARCH: Enter the log searching interface.

2.2.3 DEVICES MANAGEMENT



Advanced Features include HDD, ALARM, PTZ, MOBILE and MOTION DETECT.

2.2.3.1 HDD MANAGE



Displays essential information about the system's internal hard drive, and lets you format the internal HDD and external USB flash drive (not included).

HDD MANAGEMENT				
HDD	STATUS	ALL/FREE	FREE TIME	FORMAT
1	OK	80G/50G	2Hour	<input type="checkbox"/>
2	OK	260G/30G	5Hour	<input type="checkbox"/>
3	OK	80G/20G	5Hour	<input type="checkbox"/>
4	OK	80G/25G	13Hour	<input type="checkbox"/>

OVERWRITE **ENABLE** ▼ HDD FORMAT U DISK FORMAT

DEFAULT SAVE EXIT

The HDD menu displays the following:

- **HDD STATUS:** The system will display "OK" for normal operation
- **ALL/FREE:** The size (in Gigabytes) of the internal hard disk drive. The size of your system's internal hard drive will vary by model /The space (in gigabytes) remaining on the system's internal HDD
- **FREE TIME:** The recording time (in hours) remaining on the HDD based on your current record settings
- **OVERWRITE:** Select **ENABLE** or **DISABLE**. If Overwrite is enabled, the system will record over the oldest video data once the HDD is full. If Overwrite is disabled, the system will stop recording once the HDD is full and the "FULL" LED on the front panel of the system will light up.

Formatting the Hard Drive

ATTENTION: Formatting the HDD will erases all video data. This step cannot be Undone.

Formatting the USB Flash Drive

Use a USB flash drive to backup recorded video and upgrade the system's firmware. You should always format the USB flash drive you intend to use with the system.

NOTE: Not formatting the USB flash drive may result in improper functionality.

2.2.3.2 ALARM SETUP

Use the Alarm menu to configure alarm and email settings.

NOTE: External alarm devices must be connected to the alarm block on the rear panel of the system in order to use the I/O (input/ output) alarms of the system.

ALARM SETUP				
CH1~CH4	CH1	CH2	CH3	CH4
I/O STATUS	OFF ▼	NO ▼	OFF ▼	NO ▼
HDD LOSS	ON ▼	HDD SPACE	OFF ▼	
VIDEO LOSS	OFF ▼			
ALARM MANAGE	OUTPUT	10S ▼	BUZZER	0S ▼
	DURATION	1MIN ▼		
EMAIL SETUP	DEFILADE ALARM SETUP			
Buzzer duration time setup				
DEFAULT APPLY EXIT				

To configure alarm settings:

- 1) Under I/O CHANNEL, select **NO** (Normal Open), **NC** (Normal Closed), or **OFF**. Click **NEXT PAGE** to view additional channels (8-channel models only).
- 2) Apply loss alarms to the following:
 - **HDD LOSS**: The alarm will sound if the internal HDD is damaged
 - **HDD SPACE**: The alarm will sound when the HDD is full (overwrite must be disabled)
 - **VIDEO LOSS**: The alarm will sound when a camera is disconnected
- 3) Under ALARM MANAGE, configure the following:
 - **OUTPUT**: Set the output time (in seconds) on the spot monitor from **0s**, **10s**, **20s**, **40s**, or **60s**.
 - **BUZZER**: Set the time (in seconds) for the buzzer when an alarm is triggered—**0s**, **10s**, **20s**, **40s**, or **60s**

NOTE: Set the buzzer to **0s** if you want to disable the alarm during motion detection

- **DURATION**: Set the time (in seconds) for the system to record after a triggered alarm—**0s**, **10s**, **20s**, **40s**, or **60s**

EMAIL SETUP:

The system can send an email notification with a JPEG snapshot for triggered events on the system.

EMAIL SETUP

EMAIL	ON
SSL	<input checked="" type="radio"/> OFF <input type="radio"/> ON
SMTP PORT	00000
SMTP	
SEND EMAIL	
SEND PW	
RECV EMAIL	
INTERVAL	3MIN

DEFAULT APPLY EXIT

To setup email notification:

- 1) Under EMAIL, select **ON**.
- 2) Under SSL, select **OFF**.

NOTE: SSL deals with encryption. Only advanced users should enable this option.

- 3) Under SMTP PORT, enter the **SMTP port** of your email server.
- 4) Under SMTP, enter the **SMTP** address of your email server. For example, **smtp.gmail.com**
- 5) Under SEND EMAIL, enter the sender email address.
- 6) Under SEND PW, enter the **password** of your email server.
- 7) Under RECV EMAIL, enter the email address that will receive the email notification.
- 8) Click **APPLY**. Click **CLOSE** in the confirmation window.
- 9) Click **EXIT** in all menus until all windows are closed.

2.2.3.3 PTZ SETUP

Use the PTZ Setup menu to configure settings for a connected PTZ camera (not included).

NOTE: Consult the instruction manual of your PTZ camera for complete information about your camera, including protocol and baud rate.

PTZ SETUP				
CH1~CH4	CH1	CH2	CH3	CH4
PROTOCOL	Pelco-D	Pelco-D	Pelco-D	Pelco-D
BAUD RATE	9600	9600	9600	9600
DATA BIT	8	8	8	8
STOP BIT	1	1	1	1
VERIFY	ODD	ODD	ODD	ODD
ADDRESS	001	001	001	001

DEFAULT APPLY EXIT

To configure a PTZ camera:

- 1) Connect a PTZ camera to the BNC and 485A (TX, +) and 485B (RX, -) ports and power outlet. For more details on connecting a PTZ camera.
- 2) Under PROTOCOL, select **PELCO-D** or **PELCO-P** for the selected channel. Click **NEXT PAGE** for additional channels (8-channel models only).
- 3) Under BAUD RATE, select **1200**, **2400**, **4800**, or **9600**.
- 4) Under DATA BIT select **5**, **6**, **7**, or **8**.
- 5) Under STOP BIT, select **1** or **2**.
- 6) Under VERIFY, select **ODD**, **EVEN**, **MARK**, **SPACE**, or **NONE**.
- 7) Under ADDRESS, enter an address from **001~255** using the Virtual Keyboard. Refer to your PTZ camera's instruction manual for further details.
- 8) Click **APPLY**. Click **CLOSE** in the confirmation window.
- 9) Click **EXIT** in all menus until all windows are closed.

2.2.3.4 SYSTEM INFO

View system information, including the firmware version, MAC address, and serial number of the system.

SYSTEM INFO	
SERIAL NUMBER	0003000022
FIRMWARE VERSION	T070103
MAC ADDRESS	00-11-22-33-44-55

EXIT

2.2.3.5 MOBILE

Send alerts to your cellular phone Windows Mobile enabled touch-screen smart phone (Windows Mobile 6.0 or greater, S60 3rd or greater is required).

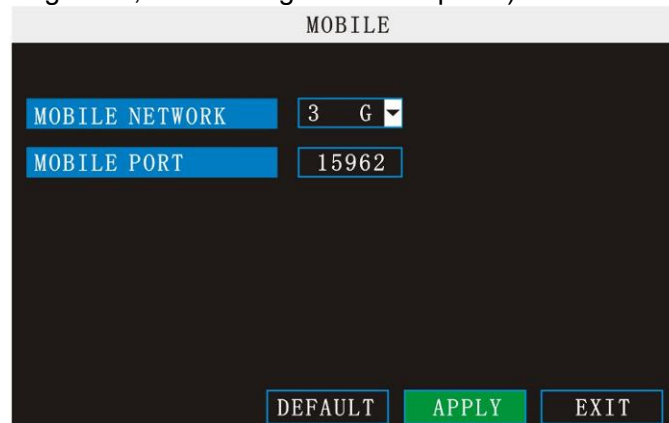

MOBILE

MOBILE NETWORK 3 G

MOBILE PORT 15962

DEFAULT APPLY EXIT

To configure mobile notification settings:

- 1) Under MOBILE NETWORK, select **3G, 2.75G, or 2.5G**.

NOTE: Contact your cellular provider if you are unsure about the network of your cellular phone.

- 2) Under MOBILE PORT, enter your mobile port number.
- 3) Click **APPLY**. Click **CLOSE** in the confirmation window.
- 4) Click **EXIT** in all menus until all windows are closed.

2.2.3.6 MOTION DETECT

Configure motion detection for each channel.

MOTION DETECTION				
CH1~CH4	CH1	CH2	CH3	Ch4
STATUS	ON	OFF	OFF	OFF
SENSITIVITY	4	3	2	3
MD AREA	SETUP	SETUP	SETUP	SETUP

DEFAULT APPLY EXIT

To configure motion detection:

- 1) Under STATUS, select **ON** to enable motion detection for the desired channel. Click **NEXT PAGE** for additional channels (8-channel models only).
- 2) Under SENSITIVITY, select **1, 2, 3, or 4**. The higher the number, the more sensitive the motion detection.
- 3) Under MD SETUP, click **SETUP**. The red motion grid appears over the selected channel in full screen.
- 4) Click the blocks in the grid to enable/disable motion detection. Red=motion detection enabled; Clear=motion detection disabled.

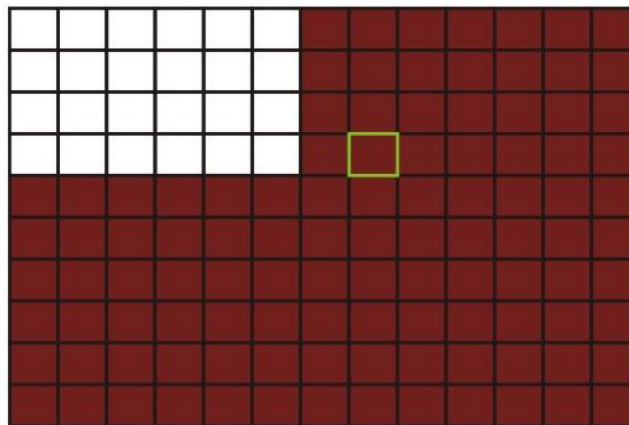

- 5) Right-click anywhere on the screen to return to the Motion Detection menu.
- 6) Click **APPLY**. Click **CLOSE** in the confirmation window.
- 7) Click **EXIT** in all menus until all windows are closed.

NOTE: You can disable the MD buzzer in the Alarm Setup menu.

2.2.3.7 SYSTEM MAINTAIN

Use the System maintain menu to update system firmware and set an automatic system reset schedule.



To enable auto-reset:

- 1) Under AUTO RESET, select **ON**. The Settings option appears.
- 2) Under SETTINGS, select **EVERY DAY**, **EVERY WEEK**, or **EVERY MONTH**. The date drop-down menu appears.
- 3) Select the date for auto-reset from the drop-down menu.
- 4) Enter the time for auto-reset using the Virtual Keyboard (mouse only).
- 5) Click **APPLY**. Click **CLOSE** in the confirmation window

To restore factory settings:

- 1) Click **LOAD DEFAULT**. This will restore the system to the original factory settings.
- 2) Click **OK** in the prompt.

To reboot:

- 1) Click **REBOOT**.
- 2) Click **OK** in the prompt.

To standby:

- 1) Click **STANDBY**.
- 2) Click **OK** in the prompt.

NOTE: Recorded video on the HDD will not be erased.

To restart the machine (soft-reset):

- 1) Click **RESTART**.
- 2) Click **OK** in the prompt. The system will perform a soft-reset and load to a live split-screen view.

To upgrade firmware:

- 1) Copy the firmware file to an empty USB flash drive. The firmware file should not be in a folder.
- 2) Connect the USB flash drive to the top USB port on the front panel of your system.
- 3) Open the System Menu (Main Menu>Advance>**System**).
- 4) Click **FIRMWARE UPDATE**. The system will scan the USB flash drive and begin updating the firmware. Do not remove the USB flash drive while the upgrade is taking place.

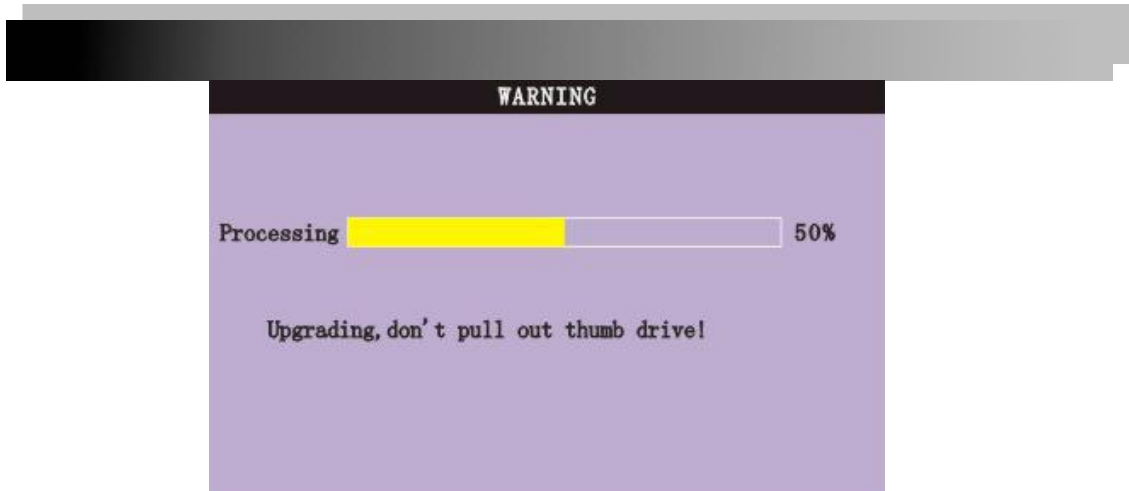

5) Click **CLOSE** in the confirmation window. In the system prompt, click **OK**. The system will restart.

PARAMETER EXPORT: Copy the system settings of the device to an empty USB flash drive.

PARAMETER IMPORT: Import system settings from another device.

2.2.4 SYSTEM SETUP



System setups include date/time, password, video/audio, language, info and maintain six options.

2.2.4.1 DATE/TIME SETUP

It is highly recommended to immediately set the date and time when first setting up your system.

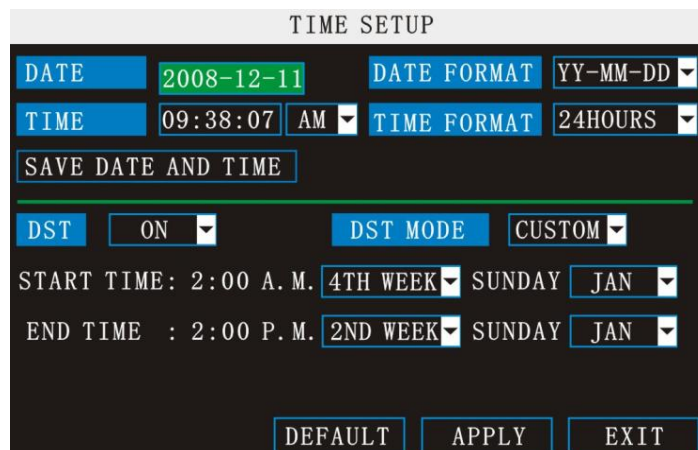

To set the date and time:

- 1) Click **DATE/TIME** and configure the following options:
 - **DATE**: Enter the day, month, and year.
 - **DATE FORMAT**: Select **DD/MM/YYYY**, **MM/DD/YYYY**, or **YYYY/MM/DD**
 - **TIME**: Enter the time
 - **TIME FORMAT**: Use the drop-down menu and select **12HOURS** or **24HOURS**
 - **DST**: Use the drop-down menu to select ON/OFF to enable/disable Daylight Savings Time
- 2) Click **MODIFY DATE AND TIME**. Click **CLOSE** in the confirmation window.
- 3) Click **APPLY**. The new date and time are saved.

Daylight Savings Time

To set daylight savings time:

- 1) Under DST, select **ON**. DST options appear.
- 2) Under DST MODE select one of the following:
 - **CUSTOM**: Set customized start and end times for DST (go to step 4)
 - **DEFAULT**: The Default setting will apply DST from the second Sunday of March to the second Sunday in November (go to step 3)
- 3) If using the DEFAULT, click **APPLY**.
- 4) If setting a CUSTOM DST, use the drop-down menus to select a week and month for the start and end times.
- 5) Click **APPLY**. Click **CLOSE** in the confirmation window.
- 6) Click **EXIT** in each menu until all windows are closed.tem date via numeric key.

2.2.4.2 PASSWORD

When you first startup your system, you are technically logged in as the ADMIN under Device ID000000. The system employs two user authorities connected to a Device ID. The authorities are as follows:

- **ADMIN**—administrator: Has full control of the system, and can change both administrator and user passwords and enable/disable password checking
- **USER**—normal user: Only has access to live viewing, search, playback, and other limited authorities. For security reasons, it is highly recommended to enable passwords on your system. If you enable passwords, you must select a 6-digit USER password and a 6-digit ADMIN password.

ATTENTION: By default, passwords are disabled on the system. You will not need a password to log in or access menus. You will not need a password to access your system using the browser-based remote software.

PASSWORD SETUP

DEVICE ID	000000		
PASSWORD ENABLE	ENABLE		
USER PASSWORD	*****	CONFIRM	*****
ADMIN PASSWORD	*****	CONFIRM	*****
NETWORK PW CLEAN:	<input type="checkbox"/>		

APPLY EXIT

You can change the Device ID and password of the ADMIN and the USER from the Password menu.

To open the Password/security menu:

1) Right-click anywhere onscreen to open the Sub-Menu and select **MAIN MENU**.

- 2) Click **BASIC**. The Basic Setup Menu opens.
- 3) Click **PASSWORD**. The Password/Security menu opens.

To change your Device ID and Password:

- 1) Click the field beside **DEVICE ID** and enter a **6-digit numerical** Device ID using the Virtual Keyboard (mouse only). For example, change the ID to 000010.
- 2) Under **PASSWORD**, select **ENABLE**.
- 3) Click the field beside **USER PASSWORD** to enter a **6-digit numerical password** using the Virtual Keyboard (mouse only). Re-enter the password in the corresponding field.
- 4) Click the field beside **ADMIN PASSWORD** to enter a **6-digit numerical password** using the Virtual Keyboard (mouse only). Re-enter the password in the corresponding field.

NOTE: The USER and ADMIN passwords must not be the same.

- 5) Click **APPLY** to save your changes. Click **CLOSE** in the confirmation window.
- 6) Click **EXIT** in each menu until all windows are closed.

Use your new password to log in to the system and access system menus. You can also use the USER and ADMIN passwords to access your system using the browser-based remote software.

NETWORK PW CLEAN: Select and click **APPLY** will initialize the IE browser password.

2.2.4.3 VIDEO/AUDIO SETUP

Use the Video/Audio menu to set the resolution and camera system on the system.

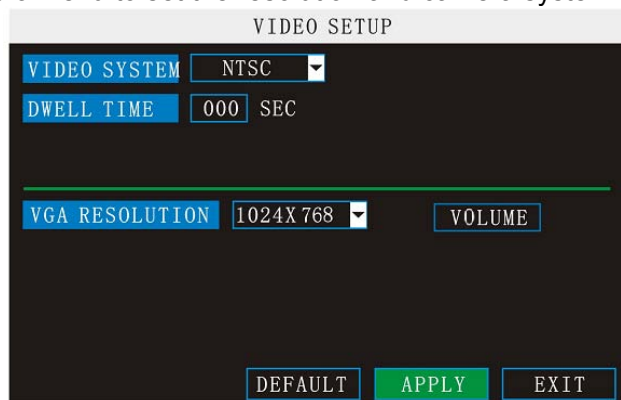

To configure video options:

- 1) Under VIDEO SYSTEM, select **NTSC** or **PAL**.
- 2) Under VGA RESOLUTION, select **800x600** or **1024x768**.
- 3) **DWELL TIME:** the interval for channel loop function.
- 4) Click **APPLY**. Click **CLOSE** in the confirmation window.
- 5) Click **EXIT** in all menus until all windows are closed.

To configure audio options:

- 1) From the Video/Audio menu, click **VOLUME SETUP**. A split-screen display view appears.
- 2) Click any channel and adjust the slider to increase/decrease the volume for listen-in audio.
- 3) Click **X** to return to the Video/Audio menu.
- 4) Click **APPLY**. Click **CLOSE** in the confirmation window.
- 5) Click **EXIT** in all menus until all windows are closed.

2.2.4.4 LANGUAGE

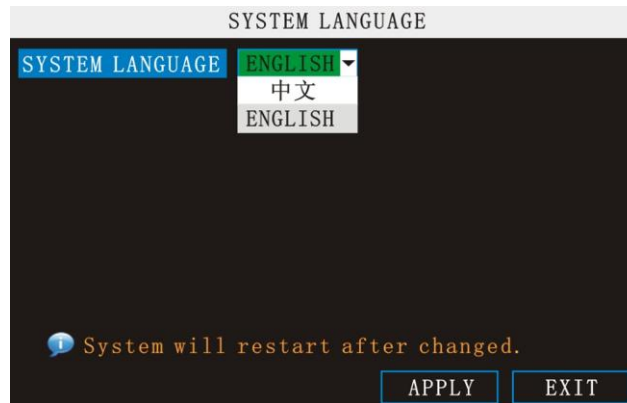

To change the system language:

- 1) From the drop-down menu select **ENGLISH**, or **CHINESE**.
- 2) Click **APPLY**. Click **CLOSE** in the confirmation window.
- 3) Click **EXIT** to close the menu.

NOTE: The device will restart when you finish system language setup.

3 IE OPERATION

3.1 FEATURE

The system features a built-in browser-based software that allows you to access your system remotely over your local area network (LAN) or over the Internet using Internet Explorer®.

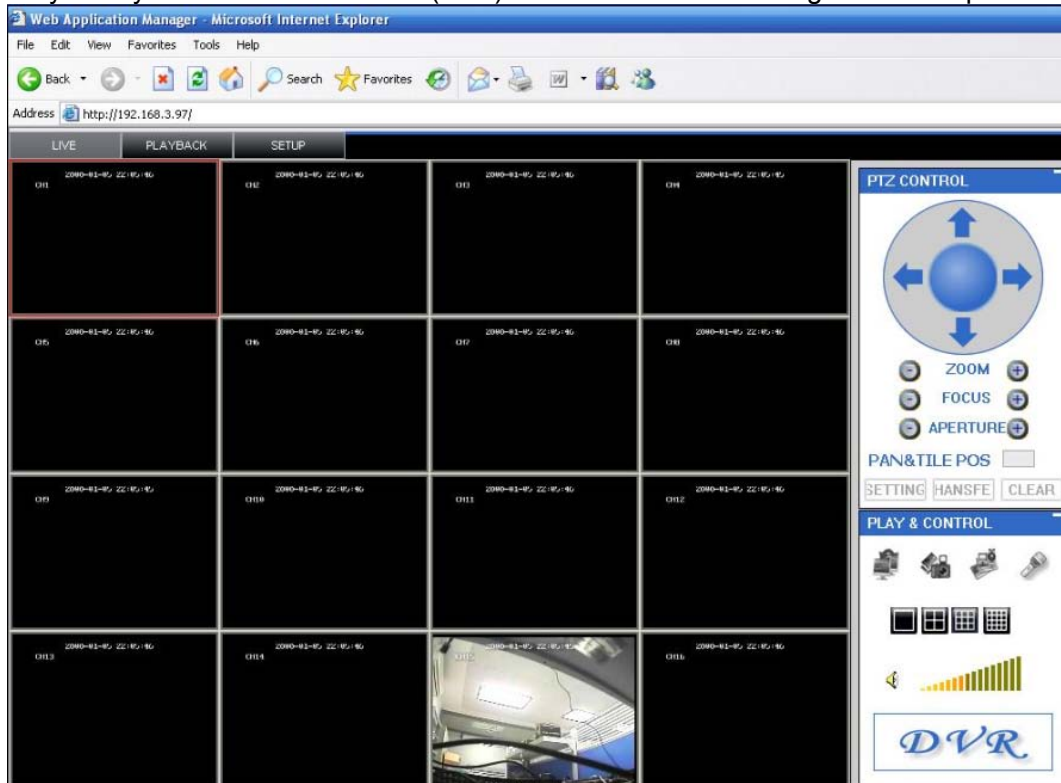

Install the software through the IE browser of OS and you operate the network remotely and conveniently. DVR supports C/S, B/S, and visit in LAN and WAN, also supports IP and domain name visiting.

RESTRICTION CONDITION:

To ensure PC,s stable visiting of DVR, recommend Windows XP, Windows Vista operation system, recommend browser as IE 6.0, IE 7.0.

3.2 USING REMOTE SURVEILLANCE

With your system connected to your local area network, you can now log in to your system using Internet Explorer.

NOTE: Your system must be connected to your local or wide area network before attempting remote access.

Logging In to Your System

With your IP address, you can now log in to your system over your local or wide area network.

NOTE: You must configure DDNS settings locally.

To access your system:

- 1) Open Internet Explorer. In the address bar, enter the IP address of your system (i.e. 192.168.3.97).
- 2) You must install the ActiveX® in order to access your system. Click the attention bar at the top of the main page and select **Install ActiveX Control**. DVR Net viewer will reset.

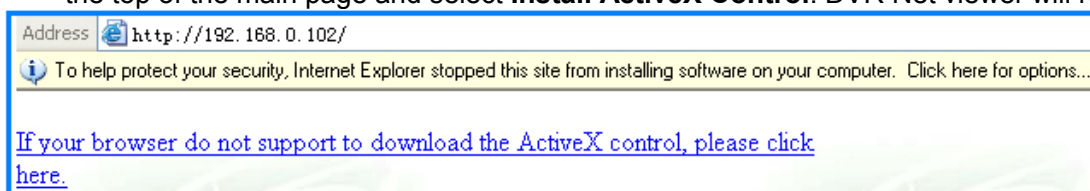
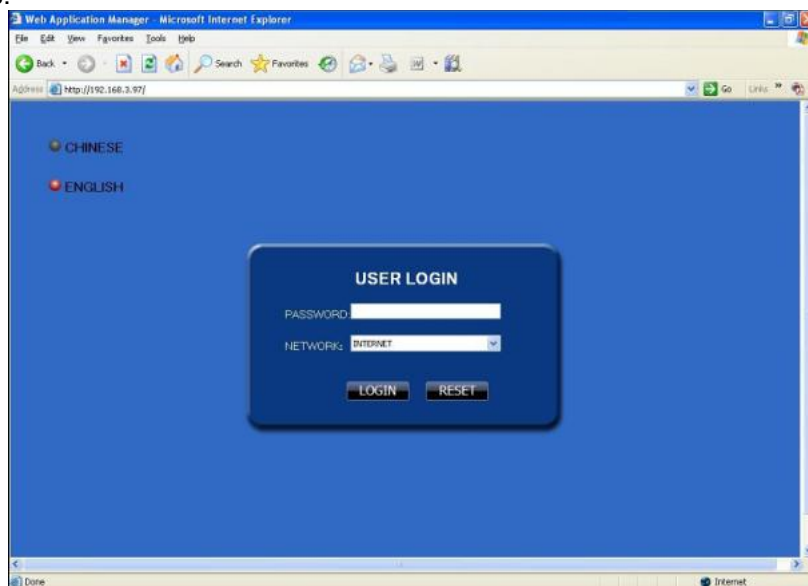

Figure 3.2.1 Click the ActiveX attention bar

- 3) In the warning box click **Install**. The login page appears.
- 4) Leave the password field **blank** (default).

NOTE: If you have enabled passwords on your system, enter your USER or ADMIN password. However, only the ADMIN can change settings and options on the system.

- 5) Select **LAN** or **INTERNET** from the drop-down menu and click **LOGIN**. The process will last for 1~2 minutes.



3.3 REMOTE SURVEILLANCE MAIN SCREEN

Upon login, the Remote Surveillance main screen appears in your browser.

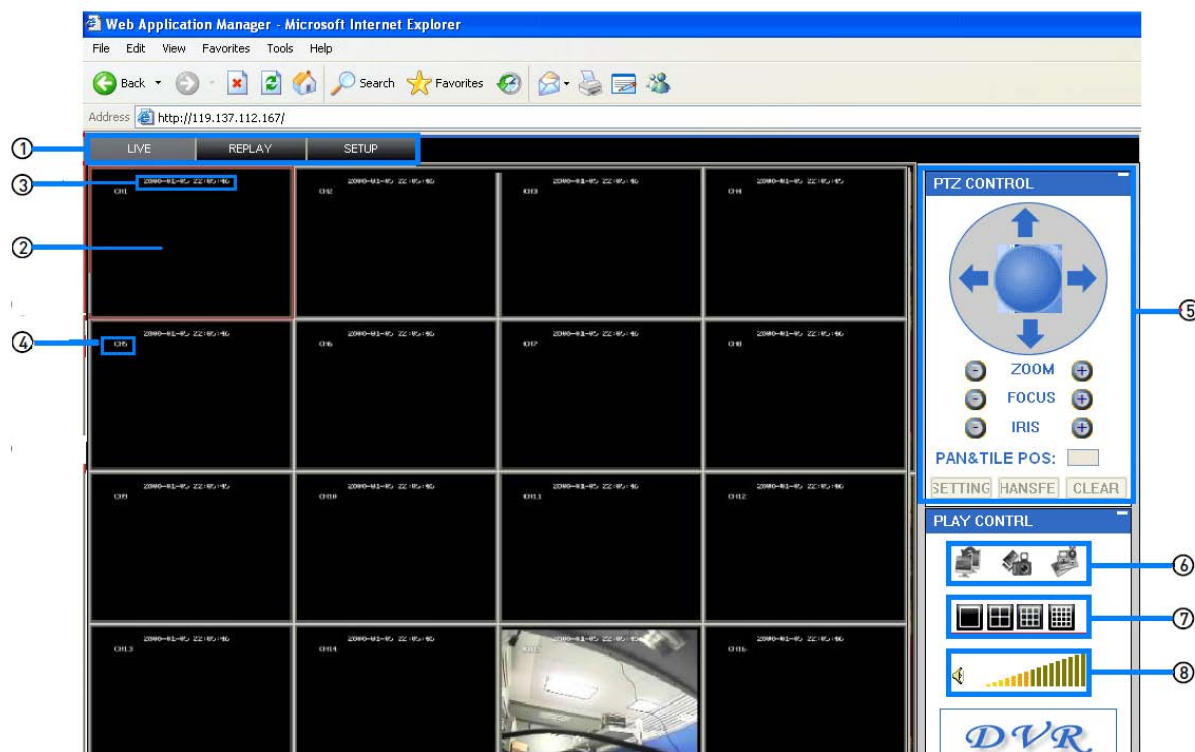



- 1) **Modes:** Click LIVE, REPLAY (playback), and SETUP.
 - 2) **Main Screen:** Main display screen for live viewing and playback.
 - 3) **Time Stamp:** Time stamp appears on each channel.
 - 4) **Channel:** Channel number appears in the top left corner.
 - 5) **PTZ Control:** PTZ control for any connected PTZ cameras (not included).
 - 6) **Functions:** Click the icons to show/hide channels, take screen captures, and record.
 - 7) **Display Modes:** Click the icons to view channels in single-channel full-screen, quad, and split-screen configurations.
 - 8) **Volume/Mute:** Select a channel (outlined in red) and then click the bars to increase/decrease volume; click the icon to mute/unmute volume.*
- *Audio capable cameras (not included) required for audio listening and recording.

3.4 LIVE VIEWING

By default, remote surveillance opens in Live Viewing mode (split-screen).

To use Live Viewing:

- 1) Click **LIVE** at the top of the main screen.
- 2) Click the display mode icons to view the main screen in **single-channel**, **quad**, or **split-screen** configurations. You can also double-click a channel at any time to view it in single-channel.
- 3) Click  to show or hide all the channel windows.
- 4) Click  to start/stop manual recording to your PC on ALL channels. For more details see RECORDING.
- 5) Select a channel (outlined in red) and then click the audio bars to increase or decrease listen-in volume. Click the icon to mute/unmute.

NOTE: The Talk function is not supported.

*Audio capable camera (not included) required for listen-in audio.

3.5 RECORDING



You can record video directly to your PC using the remote surveillance software.

To record video to your PC:

From Live viewing, click to start/stop manual recording to your PC on ALL channels

NOTE: You will record video to your PC regardless of the recording mode on the system itself. By default, recorded files are saved in C:\DVR[ip_address]\Record.

3.5.1 SUB-MENU

Right-click any channel to open the sub-menu.

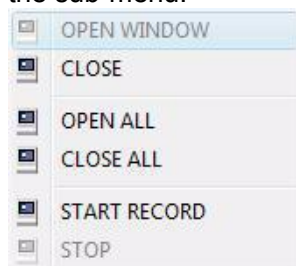

The sub-menu contains the following options:

- **Open Window**
- **Close**
- **Open All**
- **Close All**
- **Start Record**
- **Stop**

3.5.2 PTZ CONTROL

You must have a PTZ camera (not included) connected to the system in order to use the PTZ controls.

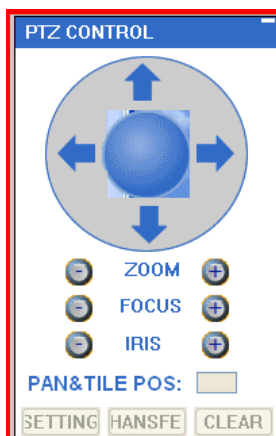

To control a PTZ camera:

1. Select the channel of the connected PTZ camera(s).
2. Click the **navigation arrows** to pan and tilt the camera.
3. Click **+ / -** to control zoom, focus, and iris.
4. Enter presets.
5. Click **SETTING**, **HAND**, and **CLEAR** to further control presets.

3.5.3 SCREEN CAPTURES

Use the remote surveillance software to take a snapshot of the channels on the main display screen. Screen Captures can be useful for your own records, or may be needed by authorities in case of a security incident.

To take a screen capture:

- 1) From Live Viewing, select the channel you want to capture. The selected channel will be highlighted in a red frame.
- 2) Click .
- 3) Click **OK** in the confirmation window. Screen captures are saved as BMP files to the default save location (C:\DVR\...).

3.5.4 PLAYBACK

Use the Replay menu to search and playback recorded video on your system.



To use the replay menu:

- 1) Click **REPLAY** at the top of the main screen. The main screen will be grey.
- 2) Click **REFRESH** below the calendar to view the recorded files for the current month.

NOTE: Normal recording is indicated by a clock icon; alarm recording (alarm, loss, and motion events) are indicated by an exclamation mark icon.

- 3) Double-click a file from the File List to playback the file in the main screen. The icon in the file list changes to "▶". Control playback using the buttons at the bottom of the main screen.



Figure 3.3.1.2.2 Progress bar

The purple bar indicates the download progress. The green marker indicates playback progress. You can click and drag the playback marker (will turn from green to orange) to advance or rewind playback as needed.

Pause	Switch between pause/play
STOP	Stop play
F.F.	Fast play
SLOW	Slow play
NEXTFRAME	Pause at next frame

SEARCH

Use the calendar and drop-down menus to search for recorded video on your system.

- 1) Click < > to change the month on the calendar. Dates with recorded video data will appear in **bold**.
- 2) Click the date. Recorded video files will populate the File List.
- 3) From the Channel drop-down menu, select a **specific channel** or select **ALL CHANNEL** and then click **SEARCH**.
- 4) From the Type drop-down menu, select **COMMON** (normal recording), **ALARM**, or **ALL TYPE** and then click **SEARCH**.
- 5) Double-click the file from the File List to playback the file in the main screen.

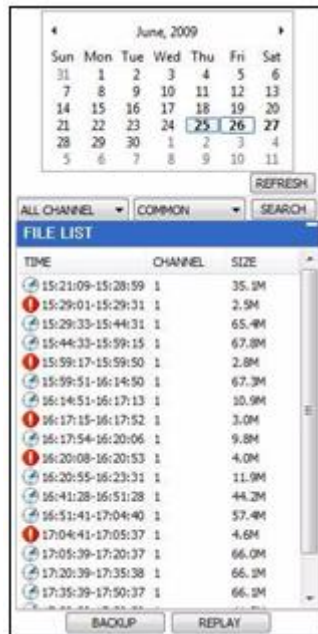

REMOTE BACKUP

You can backup recorded video files from your system to your PC using the Replay menu in the remote surveillance software.

To backup files remotely:

- 1) Click **REPLAY** at the top of the main screen.
- 2) Select a date(s) on the calendar and click **REFRESH**.
- 3) Double-click a file from the File List to begin playback.
- 4) Click **BACKUP**. Backup begins to C:/DVR/[ip_address]/Backup

NOTE: If you playback a file, you must wait for the file to load before backing it up otherwise you may receive an error message

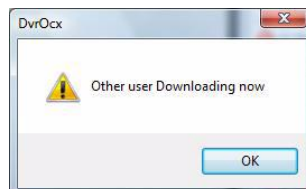

- 5) When file backup is complete, click **OK** in the confirmation window. The confirmation window show the save path of the backup file.

NOTE: Backup files are saved as **.264** files.

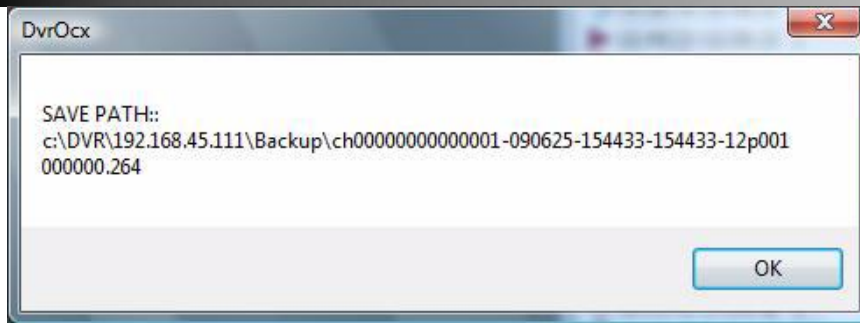

NOTE: Use the Player Software included on the software CD to playback backed up video.

3.6 REMOTE SETUP

Use the Setup tab to configure the settings of your system from a remote location.

NOTE: If the Main Menu is open on the system, you will not be able to make changes to the system from the remote location.

To open remote setup:

Click **SETUP** at the top of the main screen. The Remote Setup menu features the following tabbed options:

- **RECORD**
- **ALARM**
- **PTZ**
- **NETWORK**
- **SETTING**
- **HOST INFO**

Click  to enter into setup interface, this interface include record, alarm, PTZ, network, setting and system information six menus.

3.6.1 RECORD

Click  to enter into setup interface; you can check the parameter settings as in GUI of DVR.

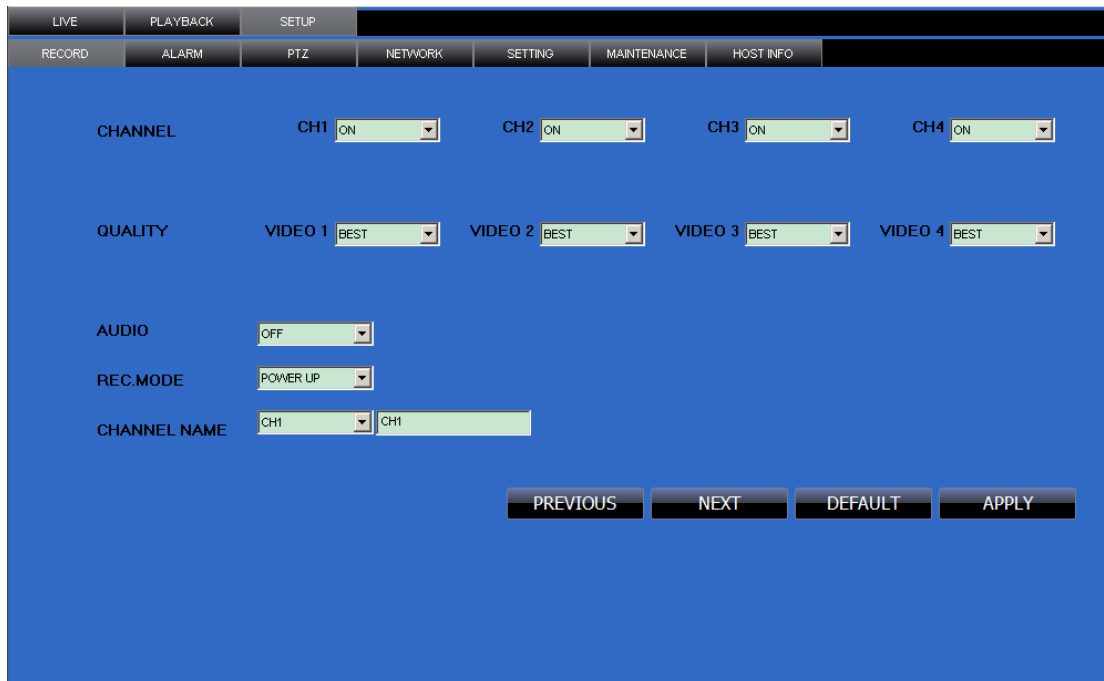

3.6.2 ALARM SETTING

Click "ALARM" to enter into setup interface; you can check the parameter settings as in GUI of DVR.

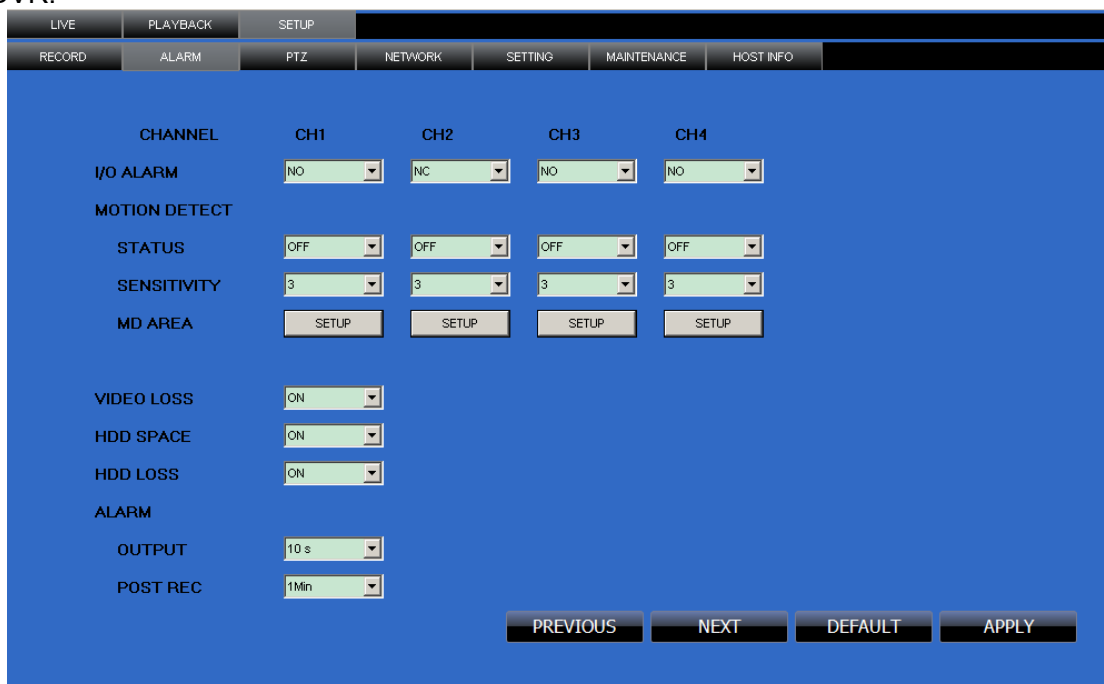

3.6.3 PTZ

Click  to access setup interface; you can check the parameter settings in GUI of DVR.

CHANNEL	CH1	CH2	CH3	CH4
PROTOCOL	PELCO-D	PELCO-D	PELCO-D	PELCO-D
ADDRESS	1	2	3	4
BAUD RATE	9600	9600	9600	9600
DATA BIT	8	8	8	8
STOP BIT	1	1	1	1
VERIFY	ODD	ODD	ODD	ODD

PREVIOUS NEXT DEFAULT APPLY

3.6.4 NETWORK

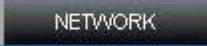
Click  to access setup interface; you can check the parameter settings in GUI of DVR.

TYPE: STATIC

IP ADDRESS: 192 . 168 . 2 . 85 MEDIA PORT: 9007

SUBNET MASK: 255 . 255 . 255 . 0 WEB PORT: 9006

PPPOE NAME: PASSWORD:

DNS: 202 . 96 . 134 . 133 GATEWAY: 192 . 168 . 2 . 1

DDNS: OFF

DOMAIN NAME: USER NAME:

SERVICE: 3322 PASSWORD:

MOBILE SETTING

NETWORK: 3G

MOBILE: 00100

DEFAULT APPLY

3.6.5 SETTING

Click  to access setup interface; you can check the parameter settings in GUI of DVR

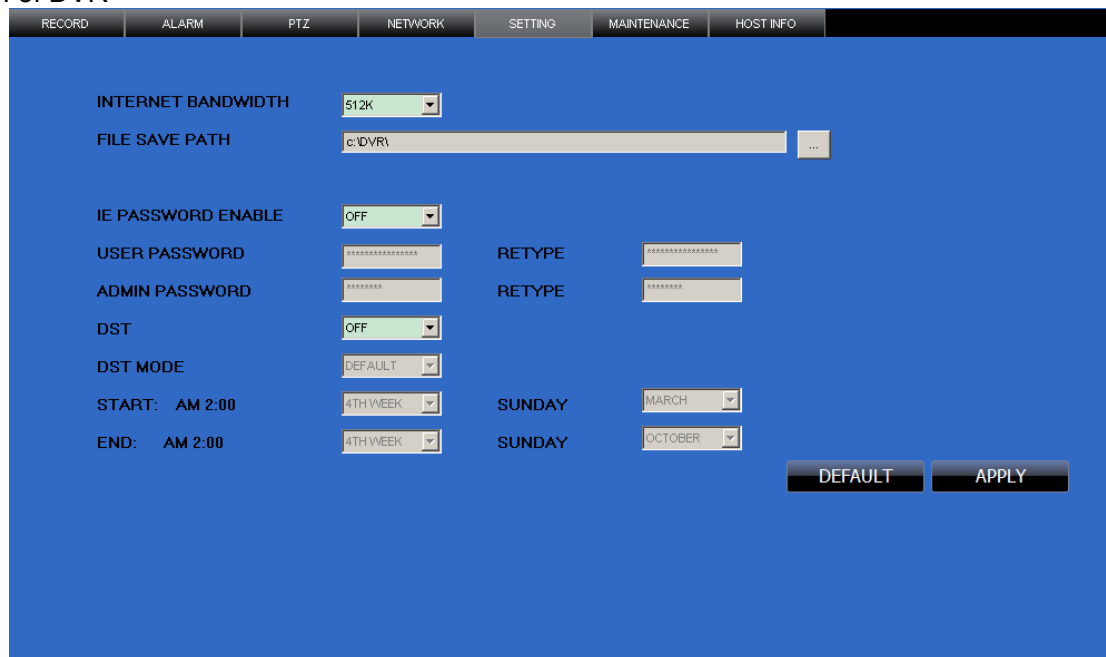

RECORD	ALARM	PTZ	NETWORK	SETTING	MAINTENANCE	HOST INFO
--------	-------	-----	---------	---------	-------------	-----------

INTERNET BANDWIDTH: 512K

FILE SAVE PATH: c:\DVR\

IE PASSWORD ENABLE: OFF

USER PASSWORD: [REDACTED] RETYPE: [REDACTED]

ADMIN PASSWORD: [REDACTED] RETYPE: [REDACTED]

DST: OFF

DST MODE: DEFAULT

START: AM 2:00 4TH WEEK SUNDAY MARCH

END: AM 2:00 4TH WEEK SUNDAY OCTOBER

DEFAULT APPLY

BANDWIDTH: Set the bandwidth in kbps (128k、192k、256k、384k、512k、1024k) that you want to allocate for traffic that matches the internet. This bandwidth does not include audio.

FILE SAVE PATH: the save path of captured picture and recording video.IE login password and DST settings you can set as DVR setting.

3.6.6 HOST INFO

Click **HOST INFO** to access system information interface (see below picture). This interface includes HDD status, remain record time, firmware version and MAC Address. All the information is fixed.

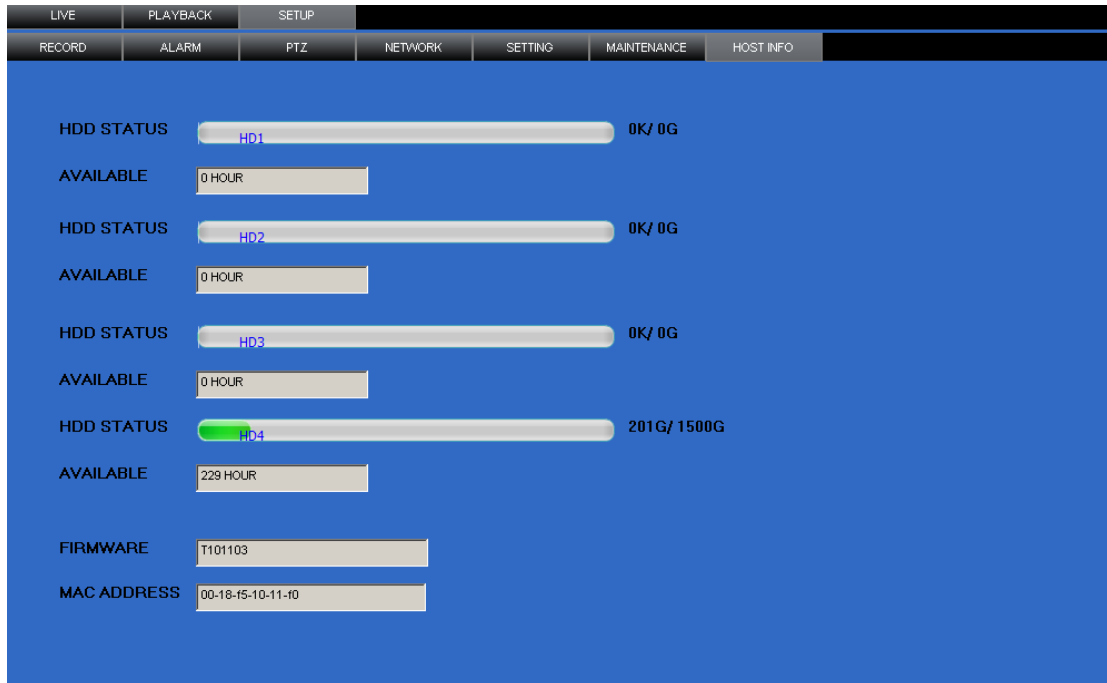

4 DVR INSTALLATION

4.1 PRODUCT OVERVIEW

1. The definition of buttons and connectors on front panel:



Buttons on Front Panel

Item	Silk-screen	Description
1	ON/OFF	POWER ON/OFF
2	Mouse	USB mouse
4	REC	Recording
	ALARM	Alarm
	HDD1	HDD1 Status
	HDD2	HDD2 Status
	HDD FULL	On means the HDD is full.
	100M	On means network is 100M
	LINK	On means network has connected
	ERROR	Error
	POWER	Power
5	IR	Remote control receiver

2. The definition of buttons and connectors on rear panel:



Connectors on Rear Panel

Item	Physical connector	Connector description
1	POWER input	DC 19V/3A
2	POWER SWITCH	POWER ON/OFF
3	Video output	Two video output for connecting TV or monitor (BNC)
4	Video input	For connecting analog video signal input (BNC)
5	Audio Input	For connecting audio signal input
6	Alarm Input	8 I/O alarm input
	Alarm Output	I/O output for alarm
	RS485	RS 485 for connecting PTZ
	RS232	For connecting PC
7	Network	For connecting Ethernet
8	VGA	For connecting VGA monitor
9	Audio Output	For connection audio output
10	USB	USB2.0/USB mouse

3. System Network Diagram

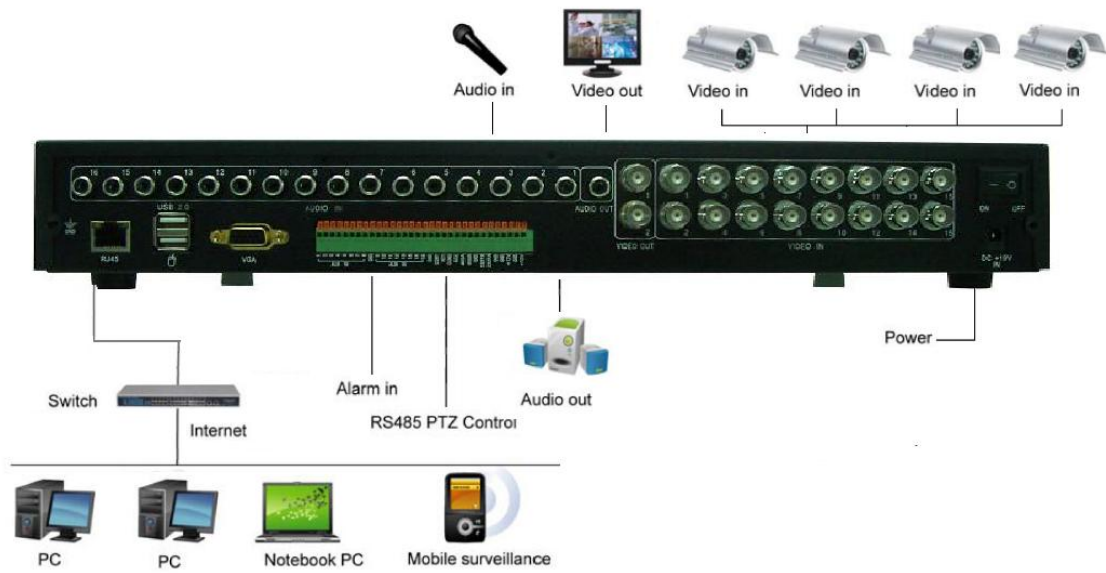

4.2 HDD INSTALLATION

Caution: When working with electrostatic sensitive devices such as hard disk drive or DVR unit, make sure you use a static-free workstation. Any electrostatic energy coming in contact with the hard disk drive or DVR can damage it permanently.

Please install the HDD with the following steps:

1) Open the cover of the DVR and you will see one HDD plate as follow:

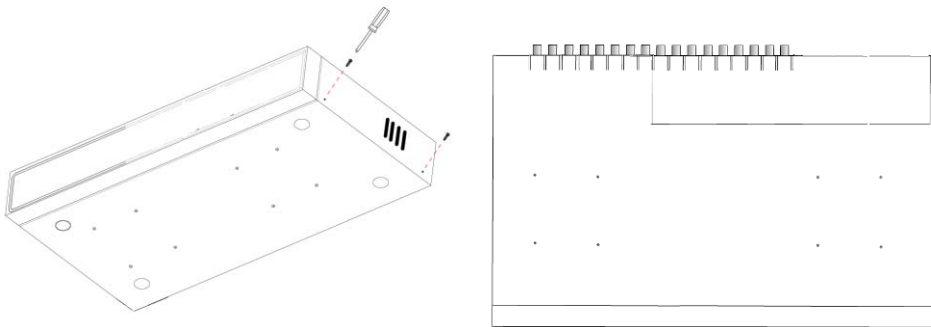

2) Connect HDD cables as follow:

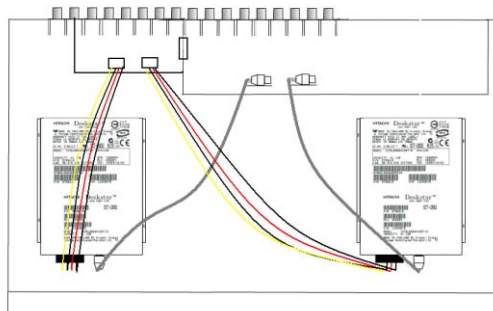

3) Secure HDD onto HDD plate as indicated below with the screws provided:

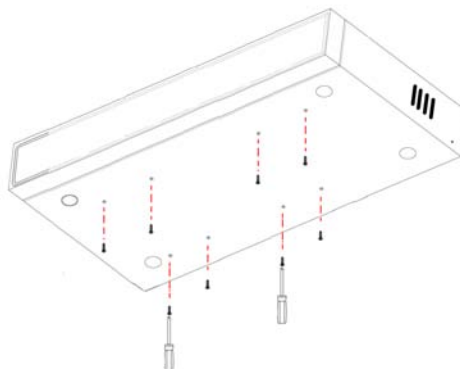

4) Install the HDD plate back into DVR and close cover.

Notice: New installed HDD must be formatted before recording.

5 FAQ

If your problem is not listed below, please call our toll-free number for more support.

1. Question: DVR is not working after starting?

Answer:

- ✧ Check the adaptor input
- ✧ Check the on-off power line, is it well-connected?
- ✧ Check the power on-off
- ✧ Check the upgrade procedure
- ✧ Check the main board of DVR

2. Question: DVR is rebooting automatically or stopped after starting the DVR for several minutes?

Answer:

- ✧ Instability or low input voltage
- ✧ Bad track hard drive or the line of hard drive is bad
- ✧ On-off power supply is not enough
- ✧ The front-end video signal instability
- ✧ High temperature, too much dust, too bad the DVR operating environment
- ✧ The main board is not well-connected with other boards
- ✧ The hardware of DVR is defective

3. Question: No output of single channel, multi channel or all channel video?

Answer:

- ✧ Please check the adaptor of camera whether to see if it is well-connected
- ✧ Please check the cable for connecting video input/output in the back panel of DVR
- ✧ Please insert the video source directly into the display device and check if they are causing the problem.
- ✧ Check the brightness of the picture and bring it back to its original default setting
- ✧ No video input signal or too weak
- ✧ Display settings in the preview set to be closed
- ✧ The hardware of DVR is defective

4. Question: DVR cannot record after startup and the interface is showing "H"

Answer:

- ✧ Make OK power adaptor is DC 19V
- ✧ Make OK HDD is formatted
- ✧ Check the power and data connection cables of the HDD
- ✧ The HDD is defective
- ✧ The SATA port is not working

5. Question: What is meaning of "R" "M" "I" "H" showed in interface?

Answer:

- ✧ "R" means the channel is recording

-
- ◇ “M” means the channel is on motion detection
 - ◇ “I” means the channel is on alarm
 - ◇ “H” means there is either no HDD. the HDD is bad or the HDD is full

6. Question: DVR is having problem with real-time images, such as bad image color or serious brightness distortion

Answer:

- ◇ If PAL and NTSC is not correctly selected on the BNC output, the images will be in black and white
- ◇ DVR is not compatible with monitor
- ◇ The video transmission distance is too far
- ◇ The setting of DVR color, brightness and so on are wrong

7. Question: No audio sound when monitoring?

Answer:

- ◇ Check sound box or speaker functions. Also check possible short circuit.
- ◇ Audio source may be connected to the video channel. You can click to full-screen to check.
- ◇ The hardware of DVR is defective

8. Question: No audio sound when playing back?

Answer:

- ◇ Setting problem: open audio-video item
- ◇ Check the audio to see if it is closed in playback interface

9. Question: System time is not correct?

Answer:

- ◇ Wrong setting or user did not click "Edit" to confirm
- ◇ Battery is not connected properly
- ◇ Battery is dead. Please change.

10. Question: Why the “Stop recording” by the right mouse button does not work, how to stop recording?

Answer:

- ◇ The “Stop recording” by the right mouse button is only suitable for Manual recording. It can't stop recording when it's in “start recording” or the video in video plan.
- ◇ If you want to stop recording, please set the time is not recording.

11. Question: "Stop recording" function by the right mouse button does not work. How to stop recording?

Answer:

The "Stop recording" by the right mouse button is for Manual Recording only. It can not stop recording when it is in "start recording" or the video is in video plan. If you want to stop recording, please set the time to not recoding.

12. Question: Motion detection is not working?

Answer:

- ◇ The setting of motion detection area is not correct
- ◇ Sensitivity is too low

13. Question: CD-writer /USB backup error

Answer:

- ✧ The data exceeds the capacity of backup device
- ✧ The backup device is incompatible
- ✧ The backup device is damaged

14. Question: Remote control cannot work?

Answer: :

- ✧ The address of remote control is not correct
- ✧ The distance of remote control is too far or the angle is too biased
- ✧ Remote control batteries run out
- ✧ Remote control is damaged or the front panel of DVR is damaged

15. Question: WEB cannot login?

Answer:

- ✧ Please check the network to see if it is connected. Check if LINK or 100M LED is displayed normally on the panel; use ping xxx.xxx.xxx.xxx (DVR IP) to check if the Internet is linked properly.
- ✧ Recommended to use Windows XP or Vista operating system, also use IE6.0 browser or IE7.0 browser
- ✧ ActiveX control has been blocked. Please manually install ActiveX control again.
- ✧ Please install DX8.1 and upgrade your video card driver

16. Question: There is no picture or picture is not clear when you preview the recording or playback the recording via IE

Answer:

- ✧ If you access DVR by IE, please choose "Wan" in "web environment"
- ✧ Please try "Close windows" by the right mouse button, and try "Open windows" again

17. Question: It displays "other members are setting....." while setting DVR by IE

Answer: It probably means someone else is setting the DVR. Please check the DVR configuration interface or exit DVR.

TROUBLESHOOTING

Error	Possible Causes	Solutions
<ul style="list-style-type: none"> System is not receiving power, or is not powering up 	<ul style="list-style-type: none"> Cable from power adapter is loose or is unplugged 	<ul style="list-style-type: none"> Confirm that all cables are connected correctly Confirm that the power adapter is securely connected to the back of the unit
	<ul style="list-style-type: none"> Cables are connected, but system is not receiving sufficient power 	<ul style="list-style-type: none"> Confirm that the system is powered on (LED indicators on the front should be ON) If the unit is connected through a power bar or surge protector, try bypassing the bar and connecting the power directly to the wall outlet Confirm that there is power at the outlet: <ul style="list-style-type: none"> Connecting the power cable to another outlet Test the outlet with another plugged device (such as an electric calculator or phone charger)
<ul style="list-style-type: none"> Remote control is not detected by the system 	<ul style="list-style-type: none"> Battery in the remote control is drained 	<ul style="list-style-type: none"> Install two fresh AAA alkaline batteries in the remote control
	<ul style="list-style-type: none"> There are no batteries in the remote control 	
<ul style="list-style-type: none"> Hard drive is not detected by the system 	<ul style="list-style-type: none"> Hard drive cables are loose or not properly connected 	<ul style="list-style-type: none"> Remove the housing and check that hard drive cables are firmly connected
	<ul style="list-style-type: none"> There is no hard drive in the system 	<ul style="list-style-type: none"> Open the housing and install a 3.5" SATA hard drive
<ul style="list-style-type: none"> Hard drive is full (0%) and the unit is no longer recording 	<ul style="list-style-type: none"> Overwrite is not enabled 	<ul style="list-style-type: none"> From the Main Menu, select HDD>Overwrite>Enable and click Apply

Troubleshooting (cont`d.)

Error	Possible Causes	Solutions
<ul style="list-style-type: none"> • Mouse not detected by system 	<ul style="list-style-type: none"> • Mouse cable is not firmly connected to the system 	<ul style="list-style-type: none"> • Firmly connect the mouse cable to the USB Mouse port on the front panel
	<ul style="list-style-type: none"> • Mouse is not connected to the system 	
	<ul style="list-style-type: none"> • System needs to be reset 	<ul style="list-style-type: none"> • Power off the system (disconnect power cable). Firmly connect a USB mouse to the USB Mouse port on the front panel of the system. Reconnect the power cable to the DC 19V port on the rear panel.
<ul style="list-style-type: none"> • There is no picture on selected channels / camera picture is not being displayed 	<ul style="list-style-type: none"> • Camera cables are loose or have become disconnected 	<ul style="list-style-type: none"> • Check the camera video cable and connections • Disconnect and reconnect the cable at the system and at the camera • Try moving the camera to another channel or use another cable
<ul style="list-style-type: none"> • The image on the DVR appears, but does not have sound 	<ul style="list-style-type: none"> • Audio cables are loose or have been disconnected 	<ul style="list-style-type: none"> • Check the AUDIO connections to the DVR
	<ul style="list-style-type: none"> • Audio channels are disabled in the system menu 	<ul style="list-style-type: none"> • Check the Configurations: Main Menu>Record>Audio
	<ul style="list-style-type: none"> • Volume on external speakers (not included) is low or off 	<ul style="list-style-type: none"> • Increase volume on external speakers (not included)
<ul style="list-style-type: none"> • A "whirring" noise is coming from the system 	<ul style="list-style-type: none"> • Fan is active 	<ul style="list-style-type: none"> • The noise means the exhaust fan is working normally.
<ul style="list-style-type: none"> • The system beeps at startup 		<ul style="list-style-type: none"> • The beep at startup is normal
<ul style="list-style-type: none"> • The system beeps during motion detection 	<ul style="list-style-type: none"> • Motion detection is enabled, but the alarm buzzer is activated 	<ul style="list-style-type: none"> • Open the Main Menu and click ADVANCE • Click ALARM; set the Buzzer to 0s and click APPLY
<ul style="list-style-type: none"> • I am not receiving email notifications 	<ul style="list-style-type: none"> • Email notification is disabled 	<ul style="list-style-type: none"> • Open Main Menu>Advance>Alarm; click EMAIL SETUP; under EMAIL select ON
	<ul style="list-style-type: none"> • Default setting is disabled, but you have not entered your own SMTP information 	<ul style="list-style-type: none"> • If you want to use your own SMTP server, deselect the Default box, and enter your SMTP Server address, Port, User name, and Password in the respective fields