



GE Fanuc Automation

Programmable Control Products

PACSystems™ RX7i

Installation Manual

GFK-2223D

April 2005

Warnings, Cautions, and Notes as Used in this Publication

Warning

Warning notices are used in this publication to emphasize that hazardous voltages, currents, temperatures, or other conditions that could cause personal injury exist in this equipment or may be associated with its use.

In situations where inattention could cause either personal injury or damage to equipment, a Warning notice is used.

Caution

Caution notices are used where equipment might be damaged if care is not taken.

Note: Notes merely call attention to information that is especially significant to understanding and operating the equipment.

This document is based on information available at the time of its publication. While efforts have been made to be accurate, the information contained herein does not purport to cover all details or variations in hardware or software, nor to provide for every possible contingency in connection with installation, operation, or maintenance. Features may be described herein which are not present in all hardware and software systems. GE Fanuc Automation assumes no obligation of notice to holders of this document with respect to changes subsequently made.

GE Fanuc Automation makes no representation or warranty, expressed, implied, or statutory with respect to, and assumes no responsibility for the accuracy, completeness, sufficiency, or usefulness of the information contained herein. No warranties of merchantability or fitness for purpose shall apply.

The following are trademarks of GE Fanuc Automation North America, Inc.

Alarm Master	Genius	PROMACRO	Series Three
CIMPLICITY	Helpmate	PowerMotion	VersaMax
CIMPLICITY 90-ADS	Logicmaster	PowerTRAC	VersaPoint
CIMSTAR	Modelmaster	Series 90	VersaPro
Field Control	Motion Mate	Series Five	VuMaster
FrameworkX	PACSystems	Series One	Workmaster
GENet	ProLoop	Series Six	

The following statements are required to appear for Class I Div 2 Hazardous Locations.

1. EQUIPMENT LABELED WITH REFERENCE TO CLASS I, GROUPS A, B, C, and D, DIV. 2 HAZARDOUS LOCATIONS IS SUITABLE FOR USE IN CLASS I, DIVISION 2, GROUPS A, B, C, D OR NON-HAZARDOUS LOCATIONS ONLY.
2. WARNING – EXPLOSION HAZARD – SUBSTITUTION OF COMPONENTS MAY IMPAIR SUITABILITY FOR CLASS I, DIVISION 2.
3. WARNING – EXPLOSION HAZARD – DO NOT DISCONNECT EQUIPMENT UNLESS POWER HAS BEEN SWITCHED OFF OR THE AREA IS KNOWN TO BE NON-HAZARDOUS.

Introduction	1-1
Getting Started	1-1
Guide to the RX7i Document Set	1-1
The PACSystems RX7i Control System.....	1-3
Hardware Description	2-1
RX7i CPUs.....	2-2
Serial Ports.....	2-2
Port 1	2-2
Port 2	2-2
Station Mgr Port.....	2-2
Ethernet Ports	2-3
MAC Address	2-3
LEDs.....	2-3
CPU Performance Specifications - IC698CPE010, IC698CPE020, IC698CRE020	2-4
RX7i Racks.....	2-6
Specifications — Standard 17-Slot Racks	2-7
Specifications — 17-Slot Rack with Rear I/O Access	2-8
Specifications — 9-Slot Racks	2-9
Power Supplies	2-10
Overview	2-10
Power Supply Operation	2-10
On/Off Switch.....	2-10
Indicators	2-11
Overvoltage Protection	2-11
Overcurrent/Short Circuit Protection.....	2-11
Over Temperature Protection	2-11
Air Flow Protection.....	2-12
VMEbus Power Monitor Interface Timing	2-12
IC698PSA100 Specifications	2-13
IC698PSA350 Specifications	2-14
Temperature Derating Curves for IC698PSA350 without Forced Air Cooling	2-15
IC698PSD300 Specifications	2-16
Temperature Derating Curve for IC698PSD300 without Forced Air Cooling	2-17
Fan Assemblies	2-18
Modules Supported by RX7i	2-19
Series 90-70 Expansion Racks	2-23
Sharing a Power Supply with a Second Expansion Rack.....	2-24
Installation Instructions	3-1
Pre-Installation Check	3-2
System Layout Guidelines	3-3
Enclosures	3-4

System Wiring	3-5
General Wiring Information	3-5
Color Coding Wires	3-5
Wire Routing.....	3-6
System Grounding	3-7
Ground Conductors.....	3-7
Equipment Grounding	3-8
Safety and Reference Ground.....	3-8
Shield Ground.....	3-8
System Installation	3-9
RX7i Rack	3-9
Front Mount 17-Slot Rack (IC698CHS117).....	3-9
Rear Mount 17-Slot Rack (IC698CHS017)	3-10
Rear Mount 17-Slot Rack with Rear I/O Access (IC698CHS217).....	3-11
Rear Mount 9-Slot Rack (IC698CHS009).....	3-14
Front Mount 9-Slot Rack (IC698CHS109)	3-15
Fan Assembly.....	3-16
Installing Fan Assemblies for 17-Slot Racks	3-16
Installing Fan Assemblies for 9-Slot Racks	3-19
Changing the Fan Filters	3-20
RX7i Power Supply	3-21
Field Wiring Connections – AC Power Supplies (IC698PSA100 and IC698PSA350).....	3-21
Field Wiring Connections – DC Power Supply (IC698PSD300)	3-22
CPU.....	3-23
Replacing the CPU Battery Pack.....	3-24
Removing a CPU from the Rack	3-25
Ethernet Interface Module.....	3-26
I/O, Communications and Intelligent Option Modules.....	3-27
I/O Module Addressing	3-27
Single-Width Modules.....	3-28
Double-Width Series 90-70 Modules.....	3-29
Power Supply Load Requirements	4-1
Power Supply Load Capacity.....	4-1
Module Load Requirements.....	4-2
Cabling Information.....	5-1
Ethernet Ports.....	5-1
Serial Ports	5-2
Port 1 Pin Assignments.....	5-2
Port 2 Pin Assignments.....	5-2
Station Manager Port Pin Assignments.....	5-3
Serial Cable Lengths and Shielding.....	5-3

Product Certifications and Installation Guidelines for Conformance.....A-1

- RX7i Agency Approvals.....A-1**
- UL Class 1 Division 2 Hazardous Location RequirementsA-2**
- ATEX Class 1 Zone 2 Hazardous Location Requirements.....A-2**
- Standards Overview.....A-3**
- Environmental SpecificationsA-3
- Additional RX7i SpecificationsA-3
- Government RegulationsA-4**
- Installation Guidelines for Conformance to StandardsA-5**
- Shielded Cable Alternative to Conduit.....A-6**
- Communication CablesA-6
- I/O CablesA-6
- Analog/High Speed CablesA-6
- Power Input to Enclosure (for Series 90-70 Power Supplies).....A-7
 - AC Power Input RF Filter RequirementsA-7
 - DC Power Input RF Filter RequirementsA-7
- Shield TerminationA-7
- Specialty Shielded Cable Vendors.....A-8
- Safety-Related Guidelines for Installation in the European UnionA-9**

Calculating Heat DissipationB-1

- Information RequiredB-1**
- Heat Dissipation Calculations.....B-2**
- Module Heat DissipationB-2
- Power Supply Heat Dissipation.....B-2
- Heat Dissipation for Discrete Output ModulesB-3
- Heat Dissipation for Discrete Input ModulesB-4
- Total Heat DissipationB-5

Getting Started

Read this chapter first to learn about the basics of the PACSystems RX7i control system hardware. To locate detailed information, check the “Guide to the RX7i Document Set” below.

Guide to the RX7i Document Set

Chapter 2 provides descriptions and general specifications of the RX7i hardware.

Chapter 3 provides installation instructions for RX7i racks and modules.

Chapter 4 provides power supply load requirements.

Chapter 5 provides cabling information.

Appendix A contains installation instructions and specifications related to product certification.

RX7i Manuals

PACSystems RX7i CPU Reference Manual, GFK-2222

PACSystems RX7i Installation Manual, GFK-2223

TCP/IP Ethernet Communications for the PACSystems RX7i, GFK-2224

Station Manager for the PACSystems RX7i, GFK-2225

PACSystems RX7i User's Guide to Integration of VME Modules, GFK-2235

C Toolkit for PACSystems, GFK-2259

Genius® Bus Controller User's Manual, GFK-2017

PACSystems RX7i Memory Xchange Modules User's Manual, GFK-2300

PACSystems Hot Standby Redundancy Manual, GFK-2308

Proficy® Machine Edition Logic Developer-PLC Getting Started, GFK-1918

Serial Communications for Series 90™ User's Manual, GFK-0582

Programmable Coprocessor Module and Support Software, GFK-0255

Series 90-70 and Genius Manuals

Series 90-70 Programmable Controller Installation Manual, GFK-0262

Series 90-70 CPU Instruction Set Reference Manual, GFK-0265

Series 90-70 Programmable Controller Datasheets Manual, GFK-0600

Series 90 PLC Serial Communications Driver User's Manual, GFK-0582

TCP/IP Ethernet Communications for the Series 90 PLC, GFK-1541

Series 90-70 PLC User's Guide to Integration of 3rd Party VME Modules, GFK-0448

MMS-Ethernet Communications for the Series 90-70 PLC User's Manual, GFK-0686

Digital Input IC697VDD100 Module User's Guide, GFK-2062

Relay Output, 64 Point IC697VDR151 Module User's Guide, GFK-2063

Digital Output, 64 Point IC697VDQ120 Module User's Guide, GFK-2066

Analog Input, 64 Channel, 16bit IC697VAL264 Module User's Guide, GFK-2056

Analog Input, Isolated, 16bit, 16 Channel IC697VAL132 Module User's Guide, GFK-2060

Eight Channel RTD/Strain Gauge IC697VRD008 Module User's Guide, GFK-2098

Analog Output, 32 Channel, 12bit IC697VAL301 Module User's Guide, GFK-2058

Series 90-70 Genius I/O System User's Manual, GEK-90486-1

Series 90-70 Genius I/O Analog and Discrete Blocks User's Manual, GEK-90486-2

Series 90-70 DLAN/DLAN+ Interface Module, GFK-0729

Programmable Coprocessor Module and Support Software, GFK-0255

Installation Requirements for Conformance to Standards, GFK-1179

The PACSystems RX7i Control System

The RX7i is part of the PACSystems controller environment that combines performance, productivity, openness and flexibility. The PACSystems control system integrates advanced technology compatible with GE Fanuc's existing systems. The result is seamless migration that protects your investment in I/O and application development.

PACSystems is driven by Machine Edition software, which provides a universal engineering development environment for programming, configuration and diagnostics of PACSystems.

RX7i Performance

The PACSystems controllers use the powerful CPUs, the Intel Celeron (300MHz) and Pentium III (700mHz), for fast execution, larger memory capacity and upgradeability to track future technology growth.

The VME64 backplane provides up to four times the bandwidth of existing VME based systems including current Series 90-70 systems for faster I/O throughput. The VME64 base supports standard VME modules including Series 90-70, RX7i, and non-GE Fanuc VME modules.

Communications features include:

- A built-in 10/100mb Ethernet port on the CPU that has dual RJ-45 ports connected through an auto-sensing switch for upload, download and online monitoring. This eliminates the need for rack-to-rack switches or hubs. The CPU Ethernet Interface provides basic remote control system monitoring from a web browser.
- Three isolated serial ports: one RS-232, one RS-485, and an RS-232 Ethernet station manager serial port.

Migration

The PACSystems RX7i control system provides cost-effective expansion of existing systems. You can upgrade on your timetable without disturbing panel wiring.

- Supports most existing Series 90-70 modules, expansion racks, and Genius networks, protecting your hardware investment. For a list of supported I/O modules, see "Modules Supported in RX7i" in chapter 2.
- Allows conversion of Series 90-70 programs to preserve existing development effort.
- Conversion of VersaPro and Logicmaster applications to Machine Edition allows smooth transition to PACSystems.

RX7i Rack System

The RX7i control system hardware consists of an RX7i rack and up to seven Series 90-70 expansion racks.

The RX7i rack can be used for all RX7i CPU and I/O configurations, most Series 90™-70 I/O, and non-GE Fanuc VME modules. Backplane connectors are spaced on 0.8" (20.3mm) centers to accommodate single-width RX7i modules and non-GE Fanuc VME modules. Series 90-70 modules use two slots each.

The RX7i rack accepts an RX7i power supply in slot 0 and an RX7i CPU with Ethernet daughterboard in slots 1 and 2. The remaining slots can be used for a combination of double-width and single-width modules.

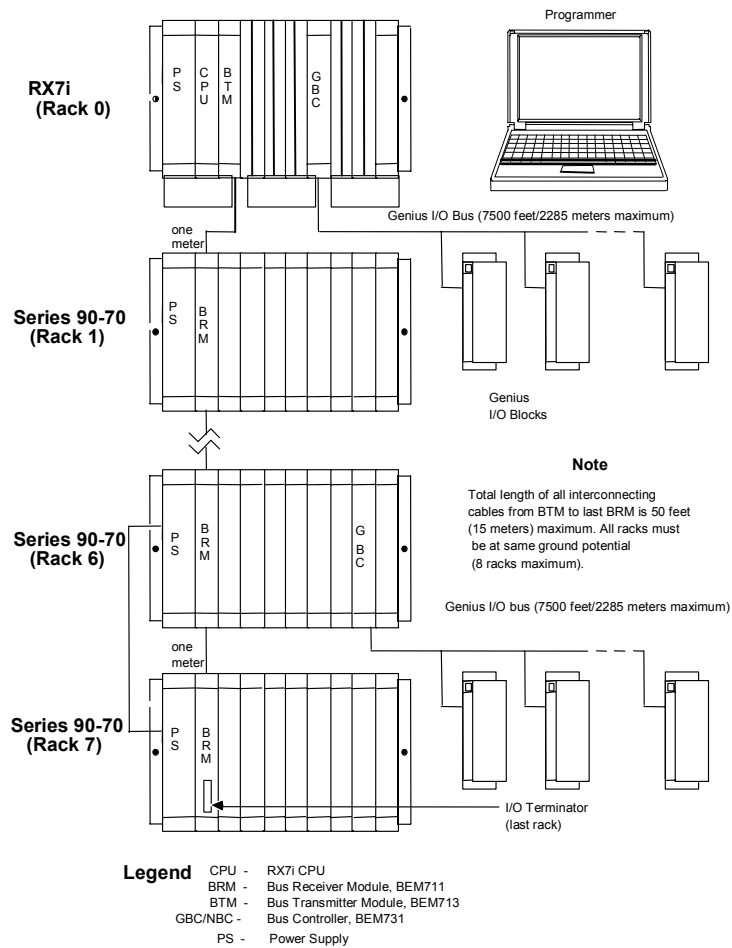

Sample Control System Configuration

The RX7i control system hardware consists of an RX7i rack and up to seven Series 90-70 expansion racks.

This chapter provides details on the following components of an RX7i control system:

- RX7i CPUs
- RX7i Racks
- Power Supplies
- Fan Assemblies
- Modules Supported in RX7i
- Series 90-70 Expansion Racks

RX7i CPUs

The RX7i CPUs are programmed and configured by the programming software to perform real time control of machines, processes, and material handling systems. The CPU communicates with I/O and smart option modules over a rack-mounted backplane using the VME64 Standard format. It communicates with the programmer and/or HMI devices via the embedded Ethernet ports or via the serial ports 1 and 2 using GE Fanuc SNP-X, Serial I/O, or Modbus RTU slave protocols.

IC698CPE010: 300MHz CPU microprocessor

IC698CPE020: 700MHz CPU microprocessor

IC698CRE020: 700MHz CPU microprocessor with redundancy

This section provides information on CPU port pinouts and other physical features. For additional details on CPU features and operation, refer to the *PACSystems RX7i CPU Reference Manual*, GFK-2222.

Serial Ports

The CPU has three independent, on-board serial ports, accessed by connectors on the front of the module. Two of these ports are used for firmware upgrades and as serial interface to external devices. The third on-board serial port is used for station management of the Ethernet interface. All serial ports are isolated. For pinout information, refer to chapter 5.

Port 1

Port 1 is RS-232 compatible and optocoupler isolated. It has a 9-pin, female, D-sub connector with a standard pin out. This is a DCE (data communications equipment) port that allows a simple straight-through cable to connect with a standard AT-style RS-232 port.

The Port 1 indicator provides the status of serial port activity.

Port 2

Port 2 is RS-485 compatible and optocoupler isolated. It has a 15-pin, female D-sub connector. This port does not support the RS-485 to RS-232 adapter (IC690ACC901). This is a DCE port.

This port requires a shielded cable.

The Port 2 indicator provides the status of serial port activity without having a terminal connected.

Station Mgr Port

The Ethernet Station Manager port is RS-232 compatible, and isolated. Port 3 has a 9-pin, female, D-connector. This is a DCE port that allows a simple straight-through cable to connect with a standard AT-style RS-232 port. This port contains full use of the standard RS-232 signals for future use with point-to-point protocol (PPP).

Ethernet Ports

There are two shielded RJ-45 Ethernet ports on the embedded Ethernet Interface. Either or both of these ports may be attached to other Ethernet devices. Each port automatically senses the data rate (10 Mbps or 100 Mbps), duplex (half duplex or full duplex), and cabling arrangement (straight through or crossover) of the attached link. The use of shielded Ethernet cables is optional.

Caution

The two ports on the Ethernet Interface must not be connected, directly or indirectly to the same device. The hub or switch connections in an Ethernet network must form a tree, otherwise duplication of packets may result.

MAC Address

The MAC Address label indicates the globally unique Media Access Control (MAC) address used by the CPU Ethernet interface. The MAC Address label is located on the rear inside wall of the battery compartment.

LEDs

The CPU has five LEDs and the embedded Ethernet interface has seven LEDs that indicate the status of various functions. For details of CPU LED operation, refer to the *PACSystems RX7i CPU Reference Manual*, GFK-2222. For details of Ethernet LED operation, refer to the *TCP/IP Ethernet Communications for the PACSystems RX7i User's Manual*, GFK-2224.

CPU Performance Specifications - IC698CPE010, IC698CPE020, IC698CRE020

Note: For environmental specifications, see “RX7i General Specifications” in appendix A.

IC698CPE010, IC698CPE020, and IC698CRE020	
Battery: Memory retention	For estimated battery life under various conditions, refer to “Battery Life Estimates” in the <i>PACSystems CPU Reference Manual</i> , GFK-2222.
Lithium Battery pack	IC698ACC701
Program storage	Up to 10 Mbytes of battery-backed RAM 10 Mbytes of non-volatile flash user memory
Power requirements CPE010 CPE020, CRE020	+5 VDC: 3.2 Amps nominal +12 VDC: 0.042 Amps nominal -12 VDC: 0.008 Amps nominal +5 VDC: 4.5 Amps nominal +12 VDC: 0.042 Amps nominal -12 VDC: 0.008 Amps nominal
Operating temperature	CPE010: 0 to 50°C (32°F to 122°F) 0 to 60°C (32°F to 140°F) with fan tray CPE020, CRE020: 0 to 60°C (32°F to 140°F), fan tray required
Floating point	Yes
Boolean execution speed, typical: CPE010 CPE020	0.195ms per 1000 Boolean contacts/coils 0.14ms per 1000 Boolean contacts/coils
Time of Day Clock accuracy Elapsed Time Clock (internal timing) accuracy	Maximum drift of 9 seconds per day 0.01% maximum
Embedded communications	RS-232, RS-485, Ethernet interface
Serial Protocols supported	Modbus RTU Slave, SNP, Serial I/O To determine availability for a given firmware version, please refer to the <i>Important Product Information</i> document provided with the CPU.
Ethernet Ports	Embedded auto-sensing 10/100 Mbps half/full duplex Ethernet interface
[Optional] Station Manager cable for Ethernet Interface	IC200CBL001
VME Compatibility	System designed to support the VME64 standard ANSI/VITA 1
Program blocks	Up to 512 program blocks. Maximum size for a block is 128KB.
Memory (For a detailed listing of memory areas, refer to the CPU Reference Manual, GFK-2222C.)	%I and %Q: 32Kbits for discrete %AI and %AQ: configurable up to 32Kwords %W: configurable up to the maximum available user RAM Symbolic: configurable up to 10 Mbytes
Error Checking and Correction	CRE020 only.
Ethernet Interface Specifications	
Web-based data monitoring	Up to 16 web server and FTP connections (combined)
Ethernet data rate	10Mb/sec and 100Mb/sec
Physical interface	10BaseT RJ45
WinLoader support	Yes
Number of EGD configuration-based pages	255
Time synchronization	SNTP
Selective consumption of EGD	Yes

IC698CPE010, IC698CPE020, and IC698CRE020	
Load EGD configuration from PLC to programmer	Yes
Remote Station Manager over UDP	Yes
Local Station Manager (RS-232)	Dedicated RS-232 port
Configurable Advanced User Parameters	Yes

RX7i Racks

IC698CHS017: Rear (wall) mount, 17 slots

IC698CHS217: Rear (wall) mount, 17 slots with rear I/O access

IC698CHS117: Front mount, 17 slots

IC698CHS009: Rear (wall) mount, 9 slots

IC698CHS109: Front mount, 9 slots

The RX7i rack can be used for all RX7i CPU and I/O configurations, including Series 90-70 I/O, and VME modules. The RX7i rack accommodates two module types:

- RX7i and Series 90-70 modules, which use a detachable field wiring terminal board. Each I/O module accepts up to forty AWG #14 (2.10 mm²) wires. The wire bundle is routed out the bottom of the terminal board cavity where a cleat is provided for a tie wrap to secure the bundle to the terminal board housing. With the IC698CHS217, the VME64 J2 connector user -defined I/O pins are accessible through a rear 96-pin DIN connector. I/O wiring may be connected to these rear access connectors. If the optional rear cover is used, I/O wiring is routed out the bottom of the cover.
- VME modules, which have varying methods of connecting to field devices.

Backplane connectors are spaced on 0.8" (20.3mm) centers to accommodate single width and double width RX7i and non-GE Fanuc VME modules.

The RX7i rack:

- Accepts RX7i modules, VME modules, and some Series 90-70 modules. For a list of supported modules, refer to page 2-19.
- Provides slot sensing for Series 90-70 rack-type I/O modules. No jumpers or DIP switches on the I/O modules are required for addressing of these modules.
- Provides J2 backplane connectors to allow high-speed VME transfers of up to 64 data bits per cycle.
- Accepts plug-in RX7i AC power supplies.
- Supports an optional cooling fan assembly (required for IC698CPE020/CRE020, IC698PSA350, or any of the single-width IC697Vxx modules).
- Provides a 6-pin RJ-11 connector for connecting an I2C serial cable.
- The IC698CHS217 rack provides rear access to the VME64 J2 backplane connectors.

The rack accepts a power supply in slot 0 and a CPU with Ethernet daughterboard in slots 1 and 2. The remaining slots can be used for one of the following I/O combinations.

17-slot racks (IC698CHS017, IC698CHS217 and IC698CHS117)	Fifteen single-width modules (with no double-width modules installed) Seven double-width modules A combination of double-width and single-width modules.
9-slot racks (IC698CHS009 and IC698CHS109)	Seven single-width modules (with no double-width modules installed) Four double-width modules A combination of double-width and single-width modules.

The power supply capacity may limit the number of modules in a rack. Power requirement information is provided in chapter 4.

Specifications — Standard 17-Slot Racks

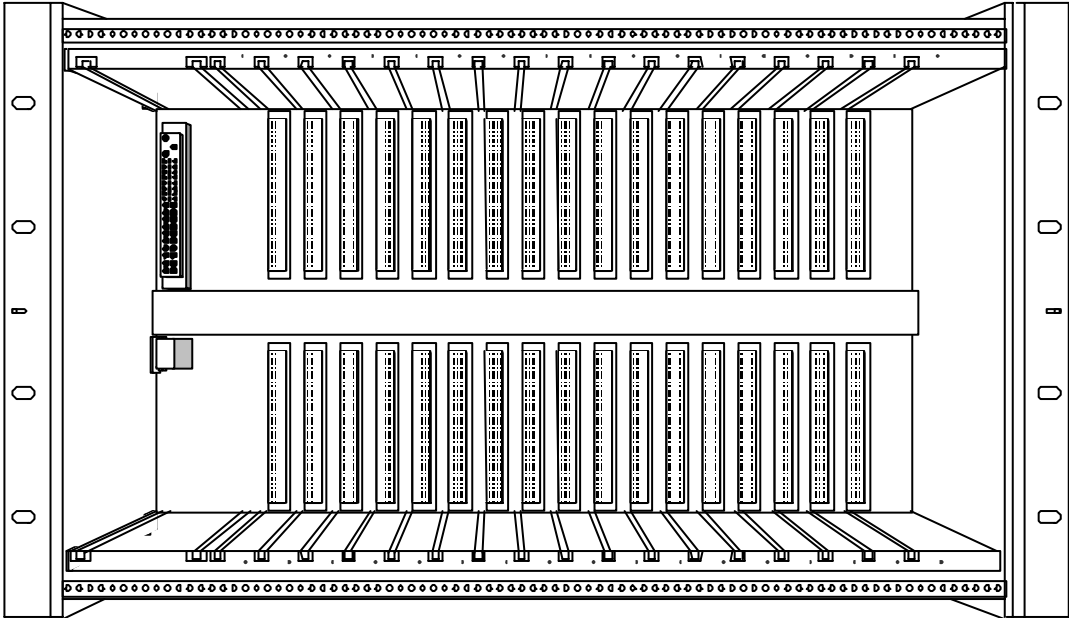

Part numbers	Rear mount IC698CHS017 Front mount IC698CHS117
Slots	Slots 1 through 17 are 0.8" (20.3mm) wide. (The CPU is installed in slot 1.) Slot 0 (power supply slot) is 2.4" (61.0mm) wide
Maximum current (from RX7i power supplies)	
100 watt supply:	+5V 20 amps (100W maximum total power allocation) +12V 2 amps -12V 1 amp
350 watt supply:	+5V 60 amps (350W maximum total power allocation) +12V 12 amps -12V 4 amps
Dimensions	<i>Height Width Depth</i> 11.15" 19.00" 7.5" 283mm 483mm 190mm <i>(Note that all Series 90-70 modules extend 1.7" (43 mm) beyond front of rack.)</i>
VME	System supports VME standard 64
Fan kits (optional, required for IC698CPE020/CRE020, IC698PSA350, or any of the single-width IC697Vxx modules)	IC697ACC721, IC697ACC724, IC697ACC744 See page 2-17 for details.

Note: For environmental specifications, see "RX7i General Specifications" in appendix A.

Specifications — 17-Slot Rack with Rear I/O Access

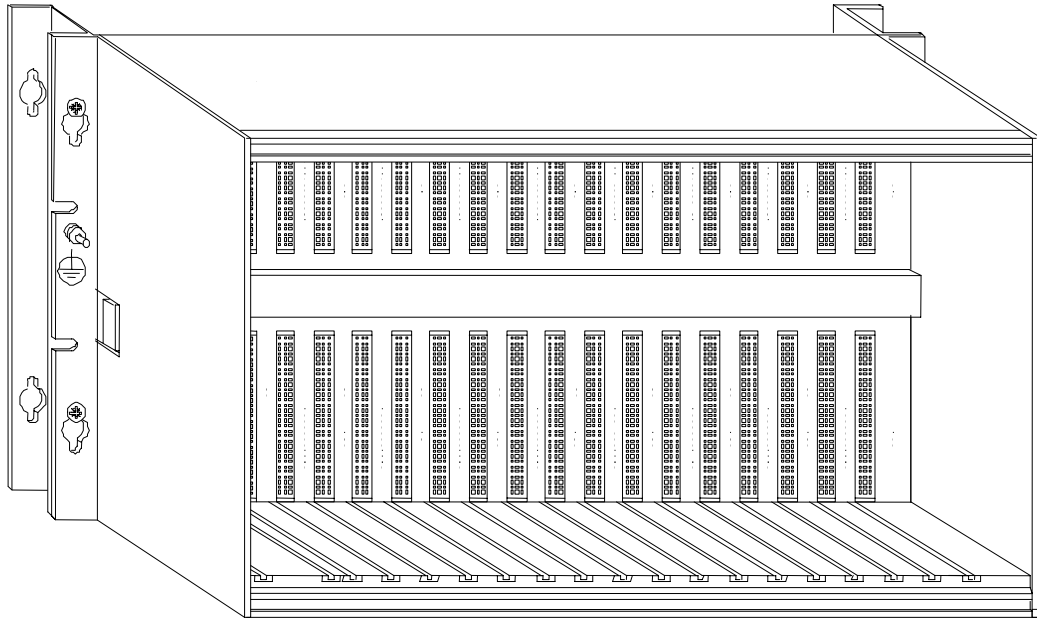

Part numbers	Rear mount IC698CHS217 (rear I/O access)
Slots	Slots 1 through 17 are 0.8" (20.3mm) wide. (The CPU is installed in slot 1.) Slot 0 (power supply slot) is 2.4" (61.0mm) wide
Maximum current (from RX7i power supplies)	
100 watt supply:	+5V 20 amps (100W maximum total power allocation) +12V 2 amps -12V 1 amp
350 watt supply:	+5V 60 amps (350W maximum total power allocation) +12V 12 amps -12V 4 amps
Dimensions (IC698CHS217)	
Without rear cover	<u>Height</u> <u>Width</u> <u>Depth</u> 11.15" 19.00" 8.875" 283mm 483mm 225mm
With rear cover	<u>Height</u> <u>Width</u> <u>Depth</u> 11.15" 19.00" 8.97" 283mm 483mm 228mm
VME	System supports VME standard 64
Fan kits (optional, required for IC698CPE020/CRE020, IC698PSA350, or any of the single-width IC697Vxx modules)	IC697ACC721, IC697ACC724, IC697ACC744 See page 2-17 for details.

Note: For environmental specifications, see "RX7i General Specifications" in appendix A.

Specifications — 9-Slot Racks

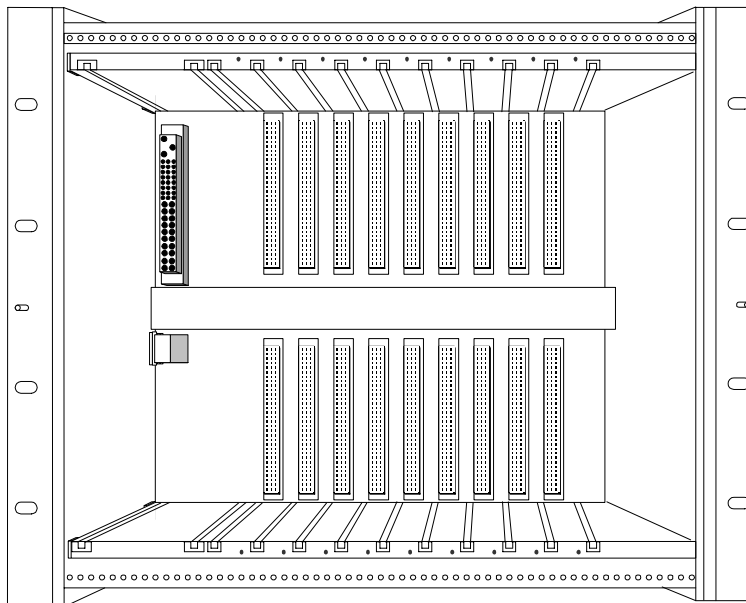

Part numbers	Rear mount IC698CHS009 Front mount IC698CHS109
Slots	Slots 1 through 8 are 0.8" (20.3mm) wide. (The CPU is installed in slot 1.) Slot 9 is 1.6" wide. If a single width module is installed in slot 9, it is recommended that a single-width filler faceplate be used to close the extra width opening. Slot 0 (power supply slot) is 2.4" (61.0mm) wide.
Maximum current (from RX7i power supplies)	
100 watt supply:	+5V 20 amps (100W maximum total power allocation) +12V 2 amps -12V 1 amp
350 watt supply:	+5V 60 amps (350W maximum total power allocation) +12V 12 amps -12V 4 amps
Dimensions	<u>Height</u> <u>Width</u> <u>Depth</u> 11.15" 12.60" 7.5" 283mm 320mm 190mm <i>(Note that all Series 90-70 modules extend 1.7" (43 mm) beyond front of rack.)</i>
VME	System supports VME standard 64
Fan kits (optional, required for IC698CPE020/CRE020, IC698PSA350, or any of the single-width IC697Vxx modules)	IC697ACC621, IC697ACC624, IC697ACC644 See page 2-17 for details.

Note: For environmental specifications, see "RX7i General Specifications" in appendix A.

Power Supplies

The RX7i power supplies provide +5V, +12V, and -12V power, and logic level sequencing signals to modules on the RX7i backplane. The power supply module plugs directly into the 47-pin connector provided in the leftmost slot in the RX7i rack. RX7i power supplies cannot be used in Series 90-70 expansion racks.

The power supply output can ride through loss of up to one input line cycle without loss of output power.

The power supplies have the following features in common:

- Slide-in rack mount construction
- Electronic short circuit overcurrent protection
- Overcurrent and overvoltage fault protection
- Power Factor correction for AC operation

Overview

<i>Catalog Number</i>	<i>Load Capacity</i>	<i>Nominal Input</i>	<i>Forced Air Cooling Required for full Capacity</i>
IC698PSA100	100 Watts	120/240 VAC or 125 VDC	No.
IC698PSA350	350 Watts	120/240 VAC or 125 VDC	Yes. For operation at limited capacity with only convection cooling, refer to the thermal derating curve on page 2-15.
IC698PSD300	300 Watts	24 VDC	Yes. For operation at limited capacity with only convection cooling, refer to the thermal derating curve on page 2-17.

Power Supply Operation

On/Off Switch

The two-position On/Off switch, located on the front faceplate, is a logic level switch that enables or disables the output channels only. This switch does not interrupt the line input.

Warning

Lethal voltages are present inside the power supply module whenever input power is supplied to the rack.

Indicators

The following LED indicators are provided on the power supply front panel.

LED Name	Color	Function
FIELD OK	green	Turns ON when AC power is applied within its specification range.
OUTPUT OK	green	Turns ON when all three DC outputs channels are operating within their specifications. Turns OFF if any of the three DC output channels has failed.
OVER TEMP (IC698PSA350 and IC698PSD300 only)	red	Turns On if the critical power supply temperature is exceeded or if the airflow sensor detects cessation of air flow.

Overvoltage Protection

Any output channel that exceeds the nominal output voltage by 15% or more will cause all outputs to latch off. The ON/OFF control switch or the user input power must be recycled to reset the power supply.

AC power supplies have replaceable fuses the hot and neutral AC inputs. DC power supplies have replaceable fuses on the positive and negative DC inputs. Make sure that power to the rack is turned off before replacing fuses.

Overcurrent/Short Circuit Protection

All outputs are protected against overcurrent and short circuit with automatic recovery upon removal of fault.

An electronic current limit is provided on each of the three outputs. An overload on any output will cause the voltage to collapse and may cause the other output voltages to collapse.

Normal operation will resume after removal of the overload. Some component cooling time may be required before normal operation resumes.

Over Temperature Protection

All RX7i power supplies have internal temperature sensing that shuts down the output channels if overheated. Recovery is automatic when the internal temperature returns to the specified operating range. The IC698PSA350 and IC698PSD300 power supplies have an OVER TEMP indicator that comes on when the output channels become overheated.

Air Flow Protection

The IC698PSA100 power supply can operate at full capacity from 0 to 60°C with only convection cooling.

The IC698PSA350 and IC698PSD300 power supplies are capable of operating at full capacity from 0 to 60°C with 70 CFM forced-air cooling provided by a fan tray mounted below the system chassis. These power supplies can operate at a limited capacity with only convection cooling. For details, see the temperature derating curves provided with the power supply specifications.

An airflow sensor is provided in the IC698PSA350 and IC698PSD300 power supplies to detect a fan failure or air blockage. If the power supply senses a cessation of airflow, it responds by latching off all outputs and turning on the overtemperature LED indicator. A power cycle is required to recover from this latched condition.

You can enable or disable the airflow sensor using a jumper located on the outside of the power supply. The airflow sensor option is enabled (jumper on pins 1 and 2) as the default for each power supply. To disable the airflow sensor, place the jumper on pins 2 and 3.

Location of Airflow Sensor Jumper – Top View

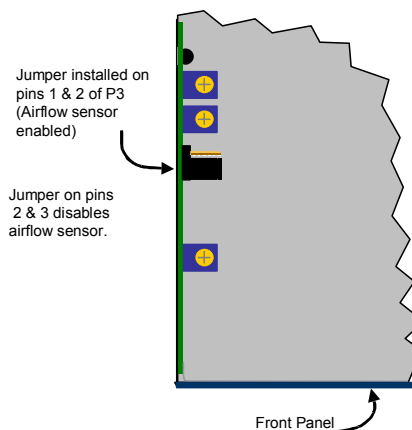

VMEbus Power Monitor Interface Timing

ACFAIL#

The ACFAIL# signal is pulled down when the power supply inputs are no longer being provided or when the ON/OFF switch is OFF. The ACFAIL# signal is asserted at least 5ms before outputs fall below their specified limits to provide sufficient warning to the system of power failure.

SYSRESET#

The RX7i power supplies does not drive the SYSRESET# signal on the VME backplane. The RX7i CPU module controls the SYSRESET# signal.

IC698PSA100 Specifications

For environmental specifications, see “RX7i General Specifications” in appendix A.

Nominal Input Rated Voltage:	120/240 VAC/125 VDC
Input Voltage Range:	85 to 264 VAC, 47 to 63 Hz, 100—150 VDC
Input Power	125 watts (typical), 142 watts (maximum)
Input Requirements Inrush current (cold start - 120VAC) Inrush current (cold start - 230VAC) Inrush current duration	15 amps maximum 30 amps maximum 100ms
Power Factor	0.99 minimum (only valid between 90VAC and 260VAC)
Output Requirements Output Power: Output Voltages: Overvoltage Limit: Overcurrent Limit:	100 watts maximum (total for all 3 outputs) +5 VDC: 4.875 to 5.25 volts, 0—20 amps +12 VDC: 11.64 to 12.6 volts, 0—2 amps -12 VDC: -12.60 to -11.64 volts, 0—1 amps +5 VDC output: 5.7 to 6.7 volts +5 VDC output: 21A (typical) +12 VDC output: 3.5A (typical) -12 VDC output: 1.6A (typical)
Isolation, input to all outputs	250 VAC continuous; 1500 VAC for 1 minute
Protective Limits Ride-through (time allowed for loss of AC input without affecting DC outputs) Holdup Time (time from system failure signal activated to when any DC output drops out of specification)	15 milliseconds minimum 5 milliseconds minimum
Operating Temperature	0°C to 60°C (32°F to 140°F)

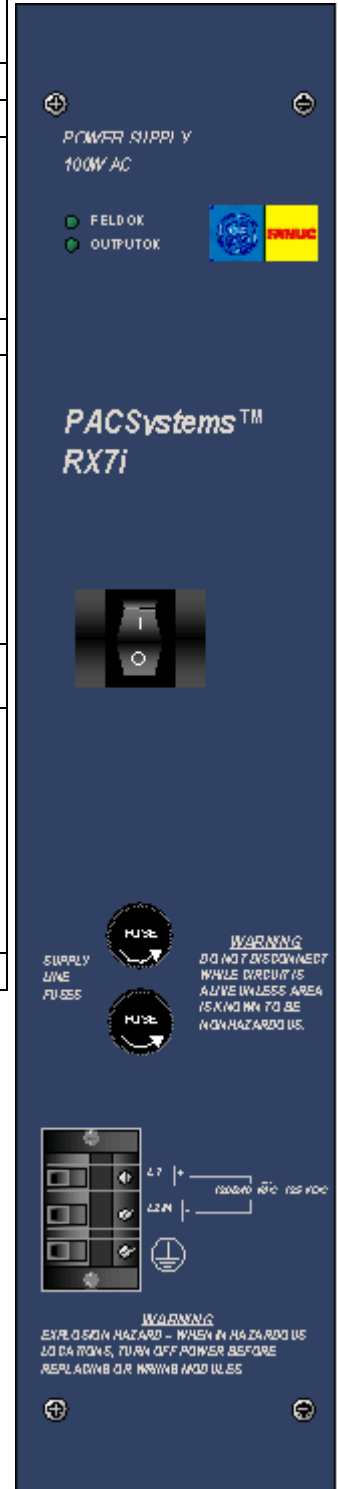

IC698PSA350 Specifications

For environmental specifications, see “RX7i General Specifications” in appendix A.

Nominal Input Rated Voltage	120/240 VAC/125 VDC
Input Voltage Range	85 to 264 VAC, 47 to 63 Hz, 100—150 VDC
Input Power	437 watts (typical), 500 watts (maximum)
Input Requirements	
Inrush current (cold start - 120VAC)	30 amps maximum
Inrush current (cold start - 230VAC)	60 amps maximum
Inrush current duration	100ms
Power Factor	0.99 minimum (only valid between 90VAC and 260VAC)
Output Requirements	
Output Power	350 watts maximum (total for all 3 outputs)
Output Voltages	+5 VDC: 4.875 to 5.25 volts, 0 to 60 amps +12 VDC: 11.64 to 12.6 volts, 0 to 12 amps -12 VDC: -12.6 to -11.64 volts, 0 to 4 amps
Overvoltage Limit	+5 VDC Output: 5.7 to 6.7 volts
Overcurrent Limit	+5 VDC output: 66A (typical) +12 VDC output: 15A (typical) -12 VDC output: 4.6A (typical)
Isolation, input to all outputs	250 VAC continuous; 1500 VAC for 1 minute
Protective Limits	
Ride-through (time allowed for loss of AC input without affecting DC outputs)	15 milliseconds minimum
Holdup Time (time from system failure signal activated to when any DC output drops out of specification)	5 milliseconds minimum
Operating Temperature	0°C to 60°C (32°F to 140°F). Fan tray attachment required for full capacity. For operation without forced-air cooling, refer to the temperature derating curve on page 2-15.

POWER SUPPLY
350W AC

● FIELD OK
● OUTPUT OK
● OVERTEMP



PACSystems™
RX7i



SUPPLY LINE FUSES



WARNING
DO NOT DISCONNECT WHILE CIRCUIT IS ALIVE UNLESS AREA IS KNOWN TO BE NONHAZARDOUS.



L1 + ———— 120/240 VAC 125 VDC ————
L2/N | ————

WARNING
EXPLOSION HAZARD - WHEN IN HAZARDOUS LOCATIONS, TURN OFF POWER BEFORE REPLACING OR WRITING MODULES.

Temperature Derating Curves for IC698PSA350 without Forced Air Cooling

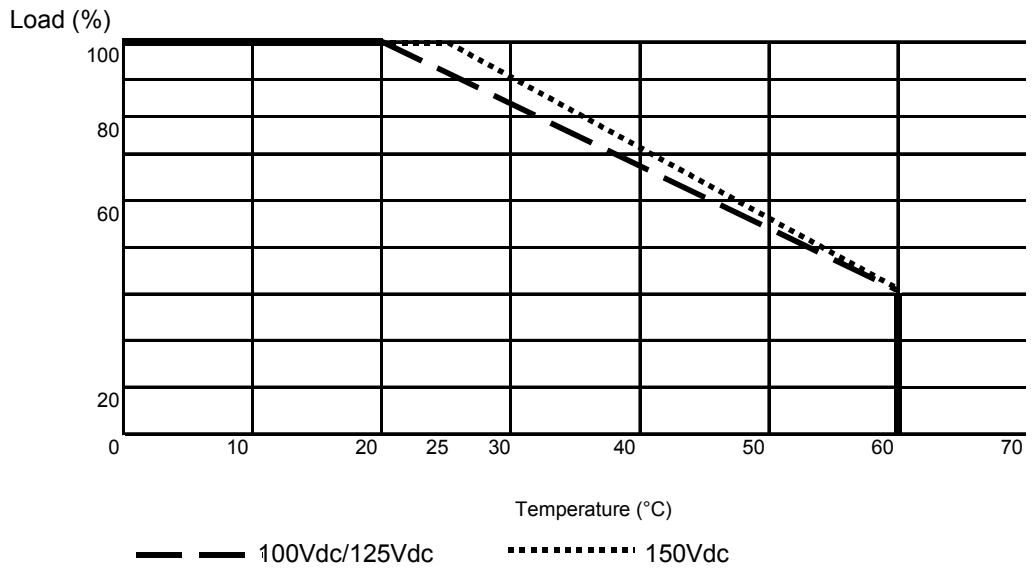
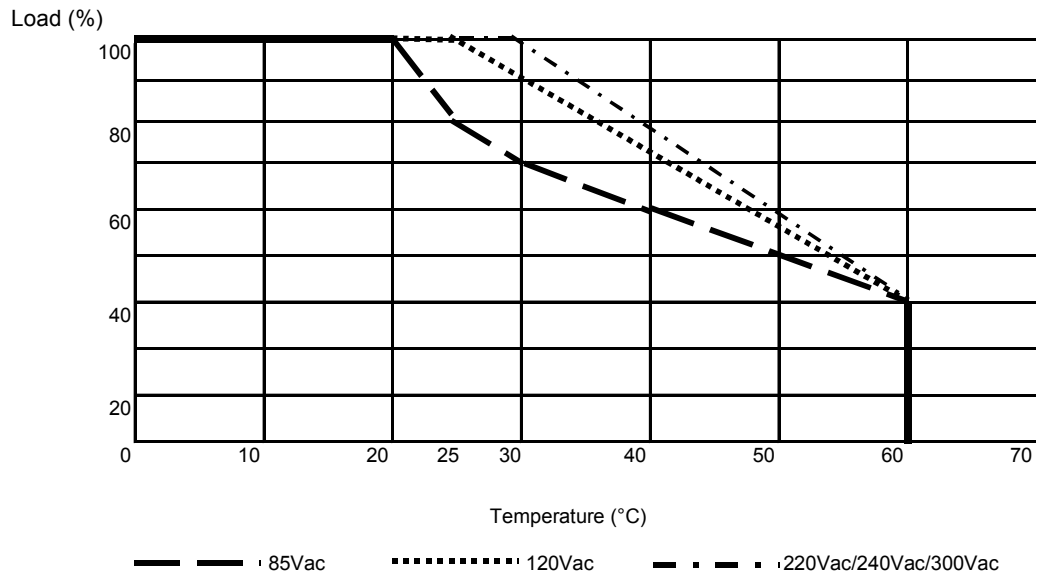

IC698PSD300 Specifications

For environmental specifications, see “RX7i General Specifications” in appendix A.

Nominal Rated Input Voltage	24 VDC
Input Voltage Range	18 to 30 VDC
Input Power	430 watts (typical), 550 watts (maximum)
Inrush current (cold start, 24 VDC)	100 amps maximum
Output Requirements	
Output Power	300 watts maximum (total for all 3 outputs)
Output Voltage	+5 VDC: 4.875 to 5.25 volts, 0 to 50 amps +12 VDC: 11.64 to 12.6 volts, 0 to 10 amps -12 VDC: -12.60 to -11.64 volts, 0 to 4 amps
Isolation, input to all outputs	250 VAC continuous; 1500 VAC for 1 minute
Protective Limits:	
Overvoltage Limit:	+5 VDC Output: 5.7 to 6.7 volts
Overcurrent Limit:	+5 VDC output: 65 A typical +12 VDC output: 15 A typical -12 VDC output: 6 A typical
Ride-through (time allowed for loss of input power without affecting DC outputs)	15 milliseconds minimum
Holdup Time (time from ACFAIL# system failure signal is activated to when any DC output drops out of specification)	5 milliseconds minimum
Operating Temperature	0°C to 60°C (32°F to 140°F). Fan tray attachment required for full capacity. For operation without forced-air cooling, refer to the temperature derating curve on page 2-17.

POWER SUPPLY
300W DC

● FIELD OK
● OUTPUT OK
● OVER TEMP



PACSystems™
RX7i



SUPPLY LINE FUSES

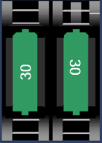

WARNING
DO NOT DISCONNECT WHILE CIRCUIT IS ALIVE UNLESS AREA IS KNOWN TO BE NONHAZARDOUS.

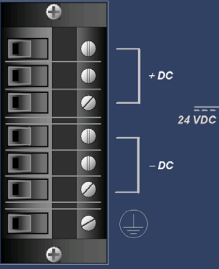

WARNING
EXPLOSION HAZARD – WHEN IN HAZARDOUS LOCATIONS, TURN OFF POWER BEFORE REPLACING OR WIRING MODULES.

Temperature Derating Curve for IC698PSD300 without Forced Air Cooling

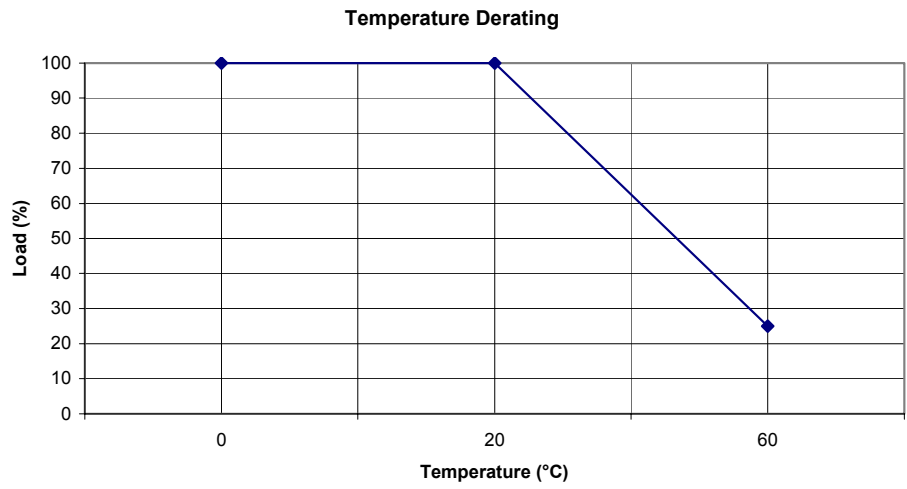

Fan Assemblies

The fan assembly provides additional rack cooling for installations where heat buildup could be a problem. The IC697ACC7xx assembly has three fans and fits 17-slot RX7i racks, 9-slot Series 90-70 racks and 17-slot VME Integrator racks. The IC697ACC6xx assembly has two fans and fits 9-slot RX7i racks and 5-slot Series 90-70 racks. The fan assembly uses fans that have a low noise level and use ball bearings for extended life.

Fan Assembly Specifications

Operating Voltage (nominal)	120 VAC, 50/60 Hz (IC697ACC721, IC697ACC621) 240 VAC, 50/60 Hz (IC697ACC724, IC697ACC624) 24 VDC (IC697ACC744, IC697ACC644)
Input Power (each fan)	15 to 20 watts at 120 VAC 16 to 20 watts at 240 VAC 6.7 watts at 24 VDC
Line Amps (each fan)	0.18 to 0.22 amps at 120 VAC 0.09 to 0.14 amps at 240 VAC 0.28 amps at 24 VDC
Locked Rotor Amps (each fan)	0.24 to 0.34 amps at 120 VAC 0.12 to 0.19 amps at 240 VAC 0.70 amps at 24VDC
Operating Temperature	-28° to +70°C (-18.4° to +158°F)
Nominal Air Flow (without filter)	@120 or 240 VAC, 60 Hz: 108 CFM (each fan)
Nominal Air Flow (with filter)	@120 or 240 VAC, 60 Hz: 71 CFM (each fan)
Weight of Fan Assembly Three-fan assembly Two-fan assembly	5.94 pounds (2.69 kg) 4 pounds
MTBF for each fan	@ 40°C (104°F) >80,000 Hours (manufacturers specification) @ 60°C (140°F) >50,000 Hours (manufacturers specification)
Filter Assembly Retainer and Guard Filter Type	UL94V-0 Plastic Polyurethane Foam, 30 PPI (Pores Per Inch)

Part Numbers

Description	Catalog Number
Rack Fan Assembly, three 120 VAC fans	IC697ACC721
Rack Fan Assembly, two 120 VAC fans	IC697ACC621
120 VAC Replacement Fans	Sinwan S109AP-11-1TB
Rack Fan Assembly, three 240 VAC fans	IC697ACC724
Rack Fan Assembly, two 240 VAC fans	IC697ACC624
240 VAC Replacement Fans	Sinwan S109AP-24-1TB
Rack Fan Assembly, three 24 VDC fans	IC697ACC744
Rack Fan Assembly, two 24 VDC fans	IC697ACC644
24VDC Replacement Fans	Sinwan SD1238AP-24HBT
Replacement Filter Element for all Rack Fan Assemblies	Comair Rotron 554146 (5 pack)

Modules Supported by RX7i

The RX7i rack accepts a power supply in slot 0 and a CPU with Ethernet daughterboard in slots 1 and 2. The remaining slots in a 17-slot rack can be used for one of the following I/O combinations:

- up to fifteen single-width modules (with no double-width modules installed),
- up to eight double-width modules, or
- a combination of double-width and single-width modules.

The remaining slots in a 9-slot rack can be used for one of the following I/O combinations:

- up to seven single-width modules (with no double-width modules installed),
- up to four double-width modules, or
- a combination of double-width and single-width modules.

The power supply capacity may limit the number of modules in a rack.

Integration of VME modules must be in accordance with the guidelines described in the *RX7i User's Guide to Integration of VME Modules*, GFK-2235.

The following modules are available for use with the RX7i control system.

Type	Slots Used	Description	Part Number	Documentation
Discrete Input	Double	12 VAC, 32pt Version A or higher	IC697MDL252	GFK-0600 GFK-0262
		24 VAC, 32pt Version A or higher	IC697MDL253	
		48 VAC, 32pt Version A or higher	IC697MDL254	
		120 VAC, 32pt Version E or higher	IC697MDL250	
		120 VAC, Isolated 16 pt Version A or higher	IC697MDL240	
		120 VAC, 16 pt Version A or higher	IC697MDL251	
		240 VAC, Isolated 16 pt Version A or higher	IC697MDL241	
		24 VDC, Pos/Neg logic, 32 pt Version B or higher	IC697MDL653	
		12 VDC, Pos/Neg logic, 32 pt Version C or higher	IC697MDL652	
		48 VDC, Pos/Neg logic, 32 pt Version C or higher	IC697MDL654	
		125 VDC, Pos/Neg logic, 16 pt Version A or higher	IC697MDL640	
		TTL, Neg logic, 32pt Version E or higher	IC697MDL651	
	24 VDC, Pos/Neg logic, 14 pt, Interrupt Version A or higher	IC697MDL671		
Single	Digital Input, 64 Point	IC697VDD100	GFK-2062	

Type	Slots Used	Description	Part Number	Documentation
Discrete Output	Double	120 VAC, 0.5A, 32pt Version E or higher	IC697MDL350	GFK-0600 GFK-0262
		120 VAC, 2.0A, 16pt Version E or higher	IC697MDL340	
		120/240 VAC, 2.0A, Isolated 12pt Version B or higher	IC697MDL341	
		5/48 VDC, 0.5A, Neg logic, 32pt Version A or higher	IC697MDL753	
		12 VDC, 0.5A, 32pt Version E or higher	IC697MDL752	
		24/48 VDC, 0.5A, 32pt Version G or higher	IC697MDL750	
		24/48 VDC, 2.0A, 16pt Version D or higher	IC697MDL740	
		Relay output, 16pt Version B or higher	IC697MDL940	
	Single	Relay Output, 64 Point	IC697VDR151	GFK-2063
Digital Output, 64 Point		IC697VDQ120	GFK-2066	
Analog Input	Double	Analog Input SBS3* and version A or higher when installed in the main rack. Version A or higher when installed in an expansion rack. Firmware version 1.6 or higher.	IC697ALG230	GFK-0600 GFK-0385
	Double	Analog Current Input, 16 Channel Version B or higher	IC697ALG440	GFK-0600 GFK-0262
		Analog Voltage Input, 16 Channel Version B or higher	IC697ALG441	
	Single	Analog Input, 64 Channel, 16 Bit Standard Performance	IC697VAL264	GFK-2056
		Analog Input, Isolated, 16bit, 16 Channel, Voltage	IC697VAL132	GFK-2060
		8 Channel RTD/Strain Gauge	IC697VRD008	GFK-2098
Analog Output	Double	Analog Voltage/Current Output, 4Channel SBS3* and version E or higher when installed in the main rack. Version C or higher when installed in an expansion rack. Firmware version 1.4 or higher.	IC697ALG320	GFK-0600 GFK-0262
	Single	Analog Output, 32 Channel, 12 Bit	IC697VAL301	GFK-2058

<i>Type</i>	<i>Slots Used</i>	<i>Description</i>	<i>Part Number</i>	<i>Documentation</i>
Intelligent Option	Double	High Speed Counter Module SBS3* and version A or higher when installed in the main rack.	IC697HSC700	GFK-1062
	Double	Programmable Coprocessor SBS3* and version PCMA1 R05 or higher when installed in the main rack. PCMA1 R05 or higher when installed in an expansion rack. Firmware version 4.05 or higher.	IC697PCM711	GFK-0255
	Double	Genius Bus Controller Module SBS3* and version B or higher when installed in the main rack. B or higher when installed in an expansion rack. Firmware version 5.8 or higher.	IC697BEM731	GFK-2017
	Single	Genius Bus Controller Module All versions.	IC687BEM731	GFK-2017
	Single	Temperature Control Module Version G or later	HE697THM160	Available from Horner APG: http://www.heapg.com
Communications	Double	Communications Coprocessor Module (CCM)	IC697CMM711	GFK-0582
	Double	DLAN/DLAN+ Interface Module SBS3* and version G01R03 or higher when installed in main rack. Not allowed in expansion racks. Firmware version 3.00 or higher.	IC697BEM763	GFK-0729
	Double	Ethernet Interface Module	IC698ETM001	GFK-2224 GFK-2225
	Single	Redundancy Memory Xchange Module	IC698RMX016	GFK-2300
	Single	Control Memory Xchange Module	IC698CMX016	GFK-2300
Bus Expansion	Single	Bus Transmitter Module (main rack only) B or higher. Version A with assembly revision "R08" or higher is also allowed.	IC687BEM713	GFK-0600 GFK-0262
	Double	Bus Receiver Module (expansion rack only) Version H or higher	IC697BEM711	GFK-0600 GFK-0262
	Double	Bus Receiver Module (expansion rack only)	IC697BEM711	GFK-0600 GFK-0262
	Single and Double	VME Modules The RX7i supports all non-GE Fanuc VME modules that the Series 90-70 system supports.	N/A	GFK-2235

***SBS3.** All modules installed in the RX7i main rack that use the SBS VME interface chip are required to have version 3 of the chip. To determine whether your module meets this requirement, look at the large square ASIC located near the top right corner of the circuit board. The chip must have the following markings. The most critical items are the last two lines: "SBS3" and "454-3". (GE Fanuc started shipping modules with SBS version 3 in 1998.)

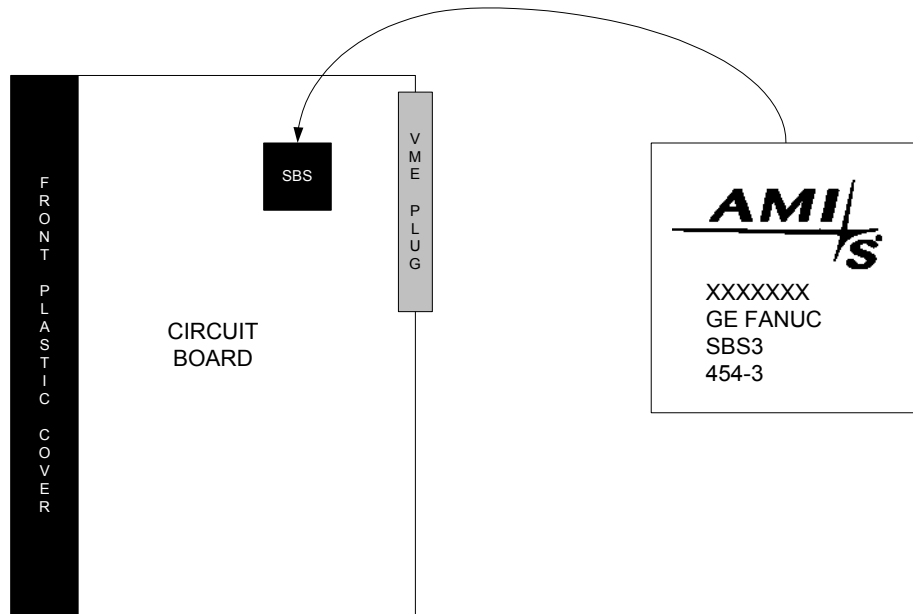

Series 90-70 Expansion Racks

The RX7i control system supports up to seven expansion racks. The following Series 90-70 racks can be used as expansion racks.

- IC697CHS750 – Five slot, rear (panel) mount
- IC697CHS782 – VME Integrator rear (panel) mount
- IC697CHS783 – VME Integrator front (rack) mount
- IC697CHS790 – Nine slot rear (panel) mount
- IC697CHS791 – Nine slot front (rack) mount

When used as expansion racks in an RX7i rack system, these Series 90-70 racks support the same Series 90-70 modules and Genius devices that RX7i main racks support. For details, see the list of modules on page 2-19.

RX7i main racks (page 2-6) cannot be used as expansion racks.

Note: Due to Series 90-70 hardware limitations, expansion racks on an RX7i rack system do not support RX7i power supplies, RX7i Ethernet modules, or the following single width modules:

- IC697VDD100, Digital Input, 64 Point
- IC697VDR151, Relay Output, 64 Point
- IC697VDQ120, Digital Output, 64 Point
- IC697VAL264, Analog Input, 64 Channel, 16bit Standard Performance
- IC697VAL132, Analog Input, Isolated, 16bit, 16 Channel, Voltage
- IC697VRD008, 8 Channel RTD/Strain Gauge
- IC697VAL301, Analog Output, 32 Channel, 12bit

For expansion rack specifications, refer to the *Series 90-70 Programmable Controller Datasheets Manual*, GFK-0600. For installation instructions, refer to the *Series 90-70 Programmable Controller Installation Manual*, GFK-0262.

The Bus Transmitter Module BTM allows expansion from the CPU rack to a maximum of seven Series 90-70 PLC expansion racks with up to 50 feet (15 meters) total of interconnecting cable. The BTM has two connectors however the RX7i only supports the one used for a daisy-chained arrangement through Bus Receiver Modules to expansion racks.

A Bus Receiver Module (BRM) must be used in slot 1 of every Series 90-70 expansion rack. The BRM has two connectors: one for attachment to the upstream or CPU rack, and the other for a daisy-chained arrangement to additional expansion racks.

An expansion rack containing a High Speed Counter module (IC697HSC700) requires Bus Receiver Module (IC697BEM711) version 13 or later.

Warning

Do not attempt to disconnect or connect an expansion rack cable while the system is under power. This could cause unexpected system operation or damage to equipment.

Sharing a Power Supply with a Second Expansion Rack

Two expansion racks can be interconnected to share a single power supply for applications having extended I/O requirements. A Power Supply Extension Cable (IC697CBL700) is available for such applications. Dual-rack operation from a single power supply can be implemented only if 5 VDC power of 5.2 amperes or less is required in the second rack.

Note: A power supply can be shared only between racks that are expansion racks to the same RX7i main rack. Do not use the power cable extension to expand power to a rack controlled by a different RX7i or Series 90-70 main rack. This will cause problems because, when the RX7i resets the expansion rack, the reset signal is sent through the power cable to the other main rack, causing it to also reset.

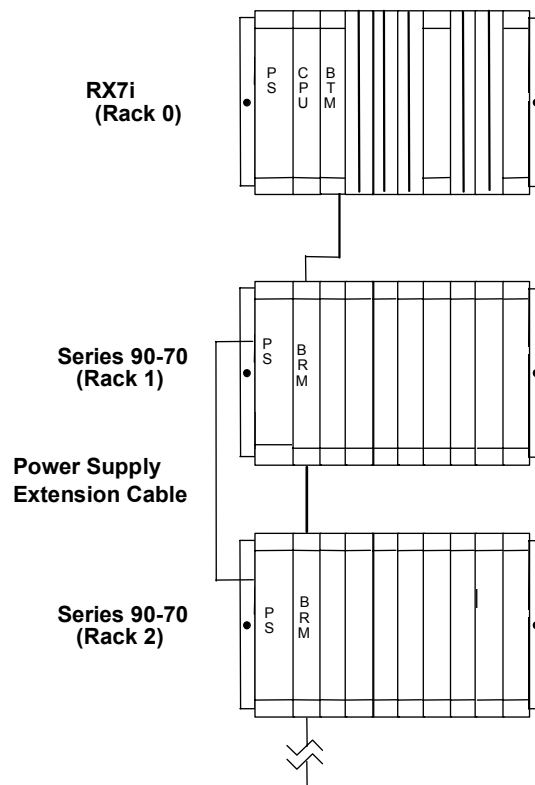

Legend

- CPU - RX7i CPU
- BRM - Bus Receiver Module, BEM711
- BTM - Bus Transmitter Module, BEM713
- PS - Power Supply

Chapter 3

Installation Instructions

This chapter describes the procedures for installing an RX7i control system and preparing the system for use. Included are instructions for unpacking, inspecting, installing the rack in a rack or panel, installing modules, and connecting cables.

- Pre-Installation Check
- System Layout Guidelines
- Enclosures
- System Wiring
- System Grounding
- System Installation
 - RX7i Rack
 - Fan Assembly
 - Power Supply
 - CPU
 - Ethernet Interface Module
 - I/O, Communications, and Intelligent Option Modules

Notes:

- RX7i racks are considered **open equipment** and therefore must be installed in a protective enclosure rated IP54 or greater.
- For installations in the European Union, an RX7i rack system with Series 90-70 products requires a metal enclosure and conduit. Requirements for installing Series 90-70 products in an RX7i rack are described in Appendix A.
- RX7i systems that include one or more Memory Xchange modules (IC698RMX016 and IC698CMX016) must be installed in a metal enclosure or equivalent to meet radiated emission standards. Requirements for installing Memory Xchange modules in an RX7i rack are described in Appendix A.
- For expansion rack installation instructions, refer to the *Series 90-70 Programmable Controller Installation Manual*, GFK-0262.

Warning

Do not attempt to disconnect or connect an expansion rack cable while the system is under power. This could cause unexpected system operation or damage to equipment.

Pre-Installation Check

Upon receiving your RX7i system, carefully inspect all shipping containers for damage during shipping. If any part of the system is damaged, notify the carrier immediately. The damaged shipping container should be saved as evidence for inspection by the carrier.

As the consignee, it is your responsibility to register a claim with the carrier for damage incurred during shipment. However, GE Fanuc will fully cooperate with you, should such action be necessary.

After unpacking the RX7i rack and other equipment, **record all serial numbers**. Serial numbers are required if you should need to contact Customer Care during the warranty period of the equipment. All shipping containers and all packing material should be saved should it be necessary to transport or ship any part of the system.

Verify that all components of the system have been received and that they agree with your order. If the system received does not agree with your order, contact customer service.

If you need technical help, technical support can be reached as follows:

Technical support for control system components described in this manual:

Customer Care	Toll free: 800-GE FANUC (800-433-2682) International direct dial: 780-420-2197
Internet	http://www.gefanuc.com/
Email	support@gefanuc.com

System Layout Guidelines

A good layout helps minimize the chance of electrical shock to personnel working on the system. It lets maintenance technicians easily access the unit to make measurements, load software, check indicator lights, remove and replace modules, etc. It also makes it easier to trace wiring and locate components while troubleshooting. In addition, proper system layout promotes good heat dissipation and helps eliminate electrical noise from the system. Excess heat and noise are two major causes of electronic component failure.

- Locate RX7i equipment away from other components that generate a lot of heat, such as transformers, power supplies, or power resistors.
- Locate RX7i equipment away from components that generate electrical noise such as relays and contacts.
- Locate RX7i equipment away from high-voltage components and wiring, such as circuit breakers and fusible disconnects, transformers, motor wiring, etc.
- Locate equipment at a convenient level that allows technicians reasonable access for maintaining the system.
- Route sensitive input wires away from electrically noisy wires such as discrete output and AC wiring. Grouping I/O modules to separate output modules from sensitive input modules can facilitate this.
- Allow a 6" minimum clearance on all four sides of each RX7i rack for ventilation/cooling.
- If your installation includes a fan assembly, a minimum clearance of 23cm (9 inches) between RX7i racks is recommended so that an individual fan can be removed and replaced.
- Use shielded cable connections with the shield grounded at one end (at source) for all analog modules, including RTD and Thermocouple modules.

Enclosures

The RX7i system and its components are considered open equipment (having live electrical parts that may be accessible to users) and must be installed in a protective enclosure or incorporated into other assemblies manufactured to provide safety. As a minimum, the enclosure or assemblies shall provide a degree of protection against solid objects 12mm and larger (e.g. fingers). This equates to a NEMA/UL Type 1 enclosure or an IP20 rating (IEC60529).

When an RX7i system is installed in an area designated as Class 1 Zone 2 in Europe, compliance with the ATEX Directive requires an enclosure with a higher degree of protection. Refer to “ATEX Class 1 Zone 2 Hazardous Location Requirements” located in Appendix A for specifications.

The enclosure must be able to adequately dissipate the heat generated by all of the components mounted inside so that no components overheat. Heat dissipation is also a factor in determining the need for enclosure cooling options such as fans and air conditioning. A minimum space of at least 152.4smm (6 inches) is required on all sides of the RX7i rack for cooling. Additional space may be required, depending on the amount of heat generated by the equipment during operation. Appendix B explains how to calculate heat dissipation for RX7i modules and field devices in an enclosure.

System Wiring

General Wiring Information

To avoid possible misrouting of wiring to I/O modules, the following is recommended:

- Label all wires to and from I/O devices. Record circuit identification numbers or other pertinent data on the inserts that go in the module's faceplate door.
- Wires should be dressed so that each field I/O connector is fixed relative to its respective module.

Warning

In addition to the information provided here, always follow all wiring and safety codes that apply to your area or your type of equipment. For example, in the United States, most areas have adopted the National Electrical Code standard and specify that all wiring conform to its requirements. In other countries, different codes will apply. For maximum safety to personnel and property you must follow these codes. Failure to do so can lead to personal injury or death, property damage or destruction, or both.

Color Coding Wires

These color codes are commonly used in industrial equipment manufactured in the United States. Where they differ from codes that apply to your area or your type of equipment, follow your applicable codes instead. Besides satisfying code requirements, wire color coding makes testing and troubleshooting safer, faster, and easier.

- Green or green with stripe- Ground
- Black - Primary AC
- Red - Secondary AC
- Blue - DC
- White - Common or neutral
- Yellow - Secondary power source not controlled by the main disconnect. Alerts maintenance personnel that there may be power present (from an external source) even if the equipment is disconnected from its main power source.

Wire Routing

To reduce noise-coupling among PLC wires, electrically-noisy wiring such as AC power wiring and discrete output module wiring should be separated from low-level signal wiring such as DC and analog input module wiring or communications cables. Where practical, group separately the following types of wiring:

- **AC power wiring.** This includes the AC input to the PLC power supply, as well as other AC devices in the control cabinet.
- **Analog Input or Output Module wiring.** This should be shielded to further reduce noise coupling.
- **Discrete Output Module wiring.** These often switch inductive loads that produce noise spikes when switched off.
- **DC Input Module wiring.** Although suppressed internally, these low-level inputs should be further protected against noise coupling by observing these wiring practices.
- **Communications Cables.** Wiring such as Genius bus or serial cables should be kept away from noise-producing wiring.

Where AC or output wiring bundles must pass near noise-sensitive signal wiring bundles, avoid running them beside each other. If they have to cross, route them a right angle to minimize coupling between them.

Grouping Modules to Keep Wires Segregated

If practical, grouping similar modules together in the racks can help keep wiring segregated. For example, one rack could contain only AC modules, and another only DC modules, with further grouping by input and output types.

System Grounding

All components of a control system and the devices it is controlling must be properly grounded. This is particularly important for the reasons listed below.

- A low resistance path from all parts of a system to earth minimizes exposure to shock in the event of short circuits or equipment malfunction.
- A low inductance path from all parts of a system to earth minimizes emissions and increases immunity to electrical interferences. A braided ground strap with a maximum 10:1 length-to-width ratio is recommended for these purposes.
- The RX7i system requires proper grounding for correct operation.

Ground Conductors

- Ground conductors should be connected in a tree fashion with branches routed to a central earth ground point. This ensures that no ground conductor carries current from any other branch. This method is shown in the figure below.
- Ground conductors should be as short and as large in size as possible. Conductors must always be large enough to carry the maximum short circuit current of the path being considered.

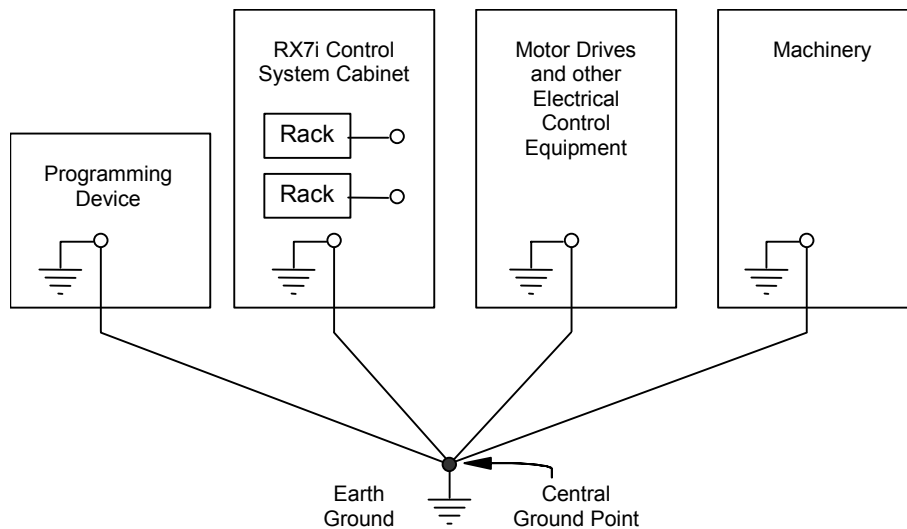

Note: Signal and power connections not shown.

Recommended System Grounding

Equipment Grounding

Equipment grounding recommendations and procedures are listed below. These grounding procedures must be properly followed for safe operation of your RX7i control system.

Safety and Reference Ground

- The ground stud on the side of the rack must be connected to earth ground using minimum AWG #12 (3.3 mm²) wire, with the shortest possible length, and a ring terminal. Use of a nut and star washer for each wire on the GND stud is recommended to ensure adequate grounding. Refer to applicable electrical safety codes.

Warning

If the ground stud on the rack is not connected, the rack is not grounded. The rack must be grounded to minimize electrical shock hazard, which may result in severe personal injury or fatality and to maintain certification to standards.

- To assure adequate module to rack grounding, all RX7i modules must have their faceplate screws tightened to ensure a good electrical connection to the rack.
- All racks that are grouped together in an RX7i control system must have a common ground connection. This is especially important for racks that are not mounted in the same control cabinet.

Shield Ground

The top and bottom rails of the rack are used for module shield grounding.

RX7i modules must have their faceplate screws tightened to ensure shield grounding. The CPU and Ethernet Interface modules' serial port shields are tied directly to the rack ground. To prevent DC loop currents caused by different ground potentials, the shield may require external capacitive coupling between the cable shield and the rack ground at one end of the cable.

The RX7i Ethernet network ports are tied directly to rack (or frame) ground. When using shielded Ethernet cables, one end of the cable needs to be capacitively coupled to its shield or local ground to prevent DC ground current loops from running through the cable shield between grounds at different potentials.

Some Series 90-70 modules have a ground clip that contacts the conductive bottom rail when the module is fully inserted. Shield connections in the user connector are routed to this ground clip through conductors on the module.

System Installation

RX7i Rack

Warning

RX7i racks are considered *open equipment*, and therefore must be installed in a protective enclosure with a rating of IP54 or greater.

Mounting requirements (front or rear mount) must be determined according to the application. Mounting flanges are an integral part of rack side panels.

Front Mount 17-Slot Rack (IC698CHS117)

The front-mount RX7i rack mounts in a standard 19" (483 mm) rack. The RX7i rack must be mounted in the orientation shown in the following figure.

The #8-32 ground stud on the sides of the rack must be connected to earth ground as detailed in "Safety and Reference Ground" on page 3-8.

Mounting Dimensions

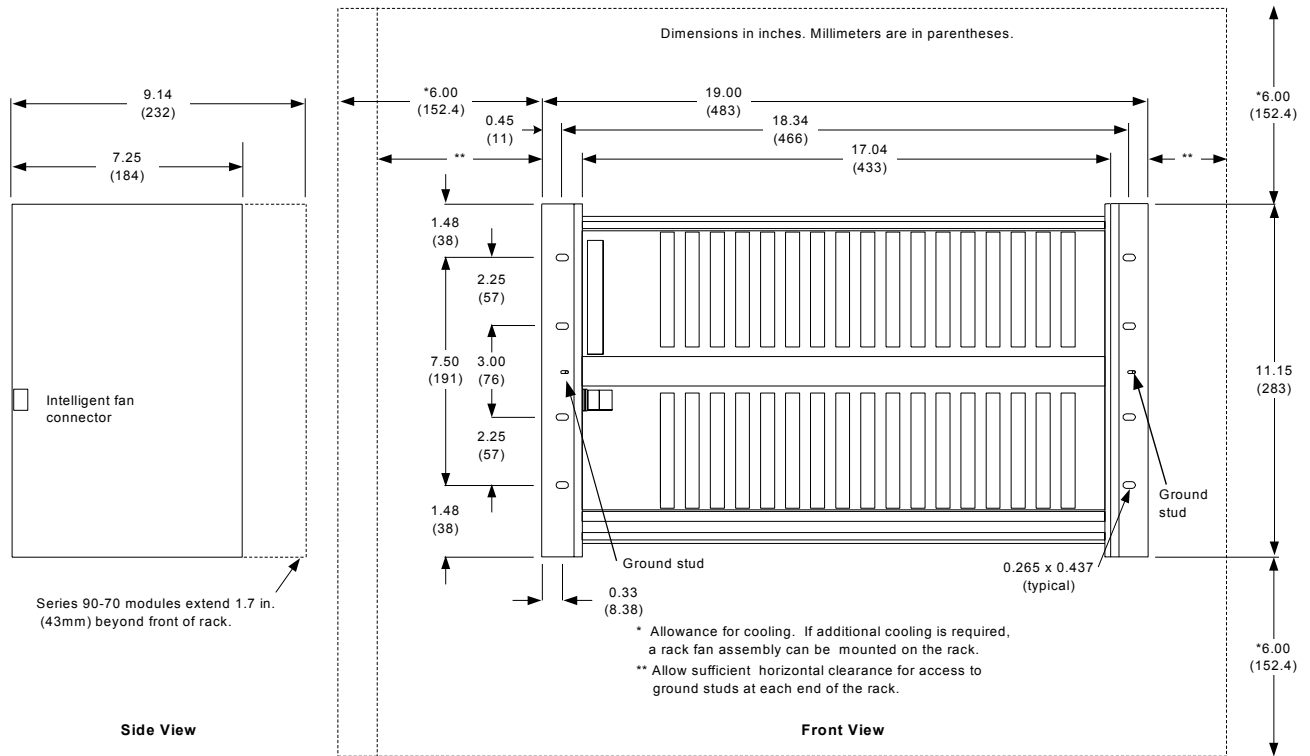

Rear Mount 17-Slot Rack (IC698CHS017)

The rear-mount rack mounts in a 10" (254 mm) deep enclosure. The rack must be mounted in the orientation shown in the following figure.

The #8-32 ground stud on the sides of the rack must be connected to earth ground as detailed in "Safety and Reference Ground" on page 3-8.

Mounting Dimensions

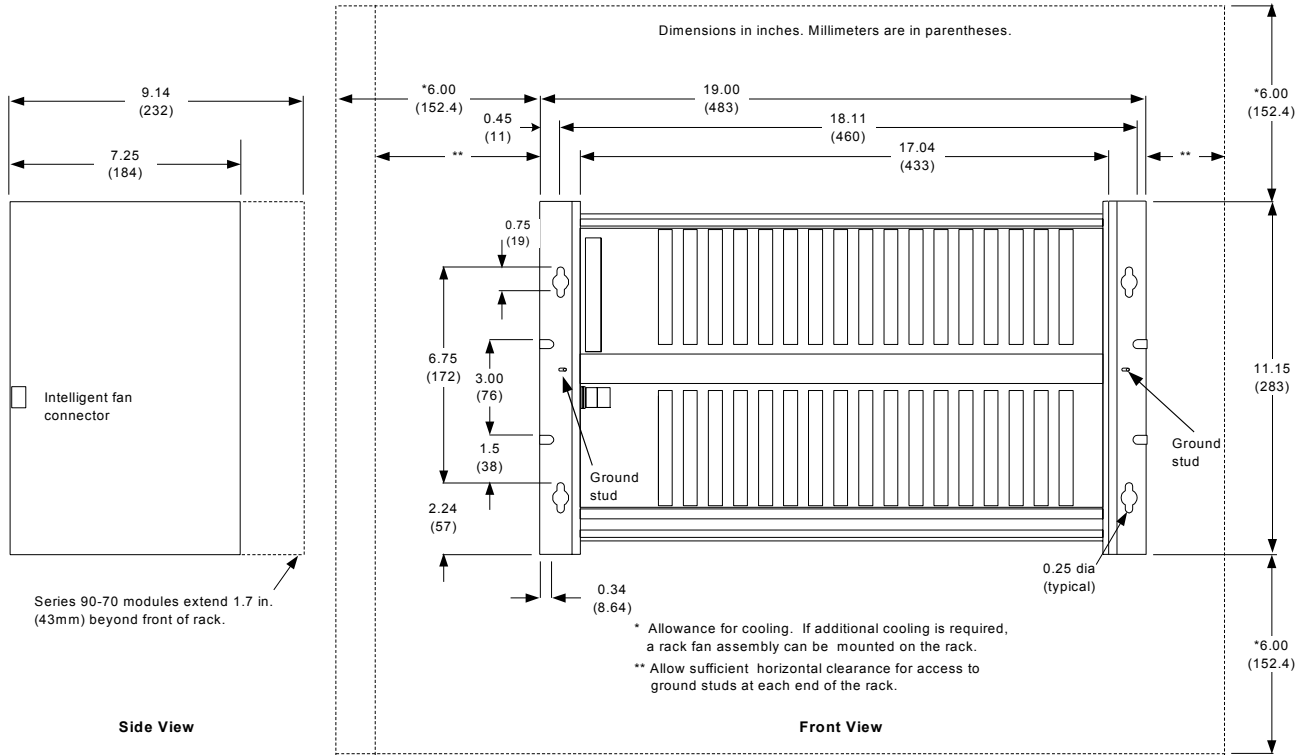

Rear Mount 17-Slot Rack with Rear I/O Access (IC698CHS217)

This rack mounts in a 10" (254 mm) deep enclosure. The rack must be mounted in the orientation shown in the following figure.

Overall rack dimensions are 11.15"H x 19"W x 8.875"D (283 x 483 x 225mm). Rack dimensions with the optional rear cover installed are 11.15"H x 19"W x 8.97"D (283 x 483 x 228mm).

To mount the rack with the rack spacers, you will need eight M6 machine screws.

The #8-32 ground stud on the sides of the rack must be connected to earth ground as detailed in "Safety and Reference Ground" on page 3-8.

To meet U.S., Canadian, Australian and European regulations for Class A digital devices and maintain CE Mark compliance, RX7i installations that include the following products must be installed in a metal enclosure with external wiring routed in metal conduit as described in Appendix A.

Mounting Dimensions

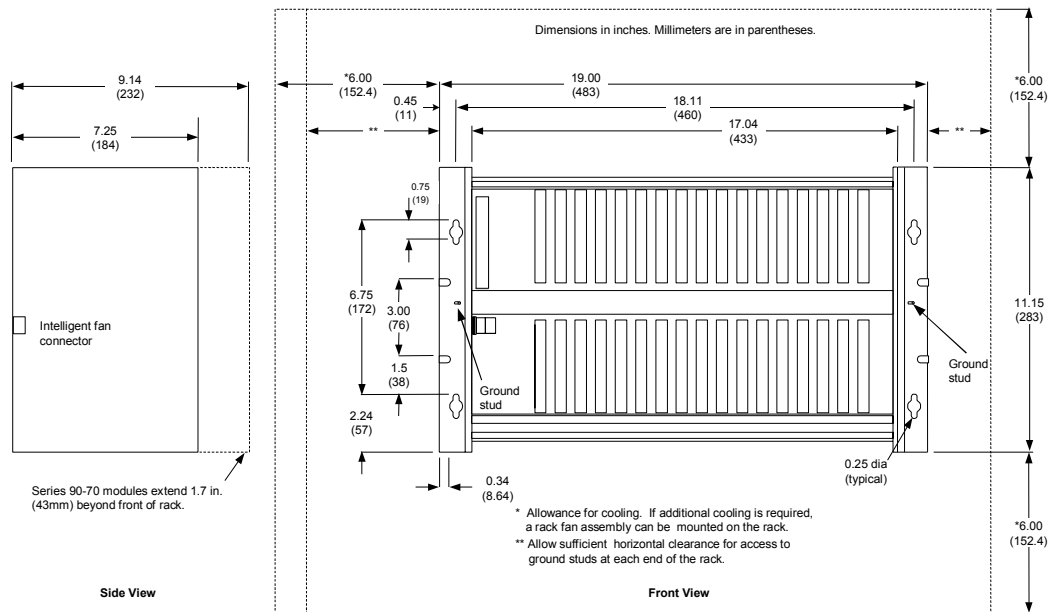

Installation Procedure for Rear I/O Access Rack

1. Fasten two rack spacers on the equipment panel, one for each side of the rack, using four M6 screws.
2. Insert four M6 screws in either the top or bottom sets of holes on the spacers. Because these will be used for mounting the rack, do not tighten them all the way down. Leave enough space between the screws and the spacer to install the rack.
3. Install any rack rear I/O wiring required for the application. Refer to the PACSystems RX7i Installation Manual, GFK-2223 for recommendations related to wiring.

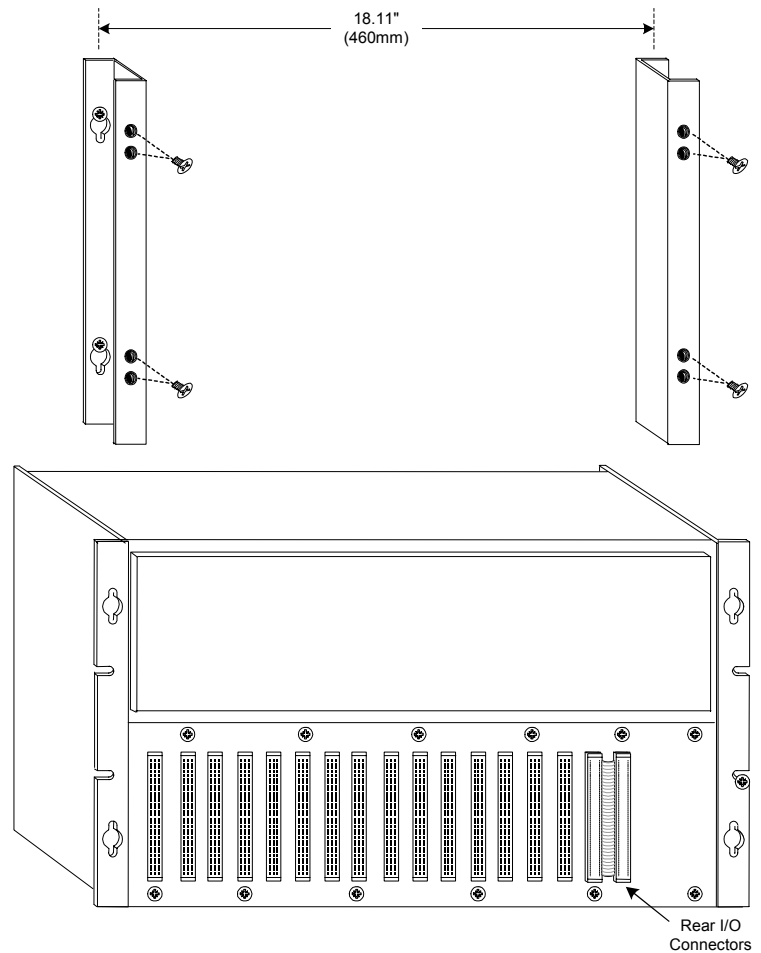

- 4. To use the optional rear cover, remove nine screws from the rear connector assembly, as indicated in the drawing to the right.

Install the cover over the rack rear connectors, with the opening facing downward. Fasten the cover to the rack using the nine screws.

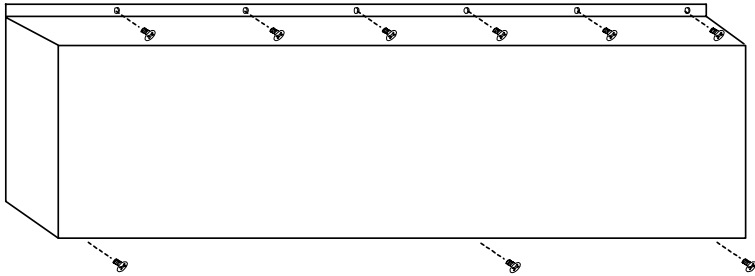
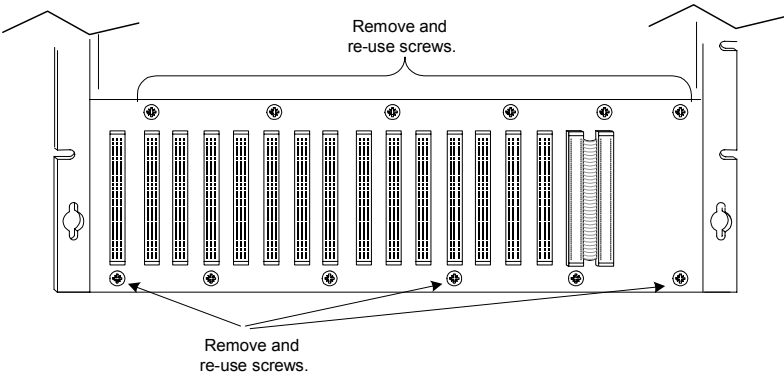

- 5. Mount the rack assembly onto the spacer screws and tighten the screws to firmly hold the rack.

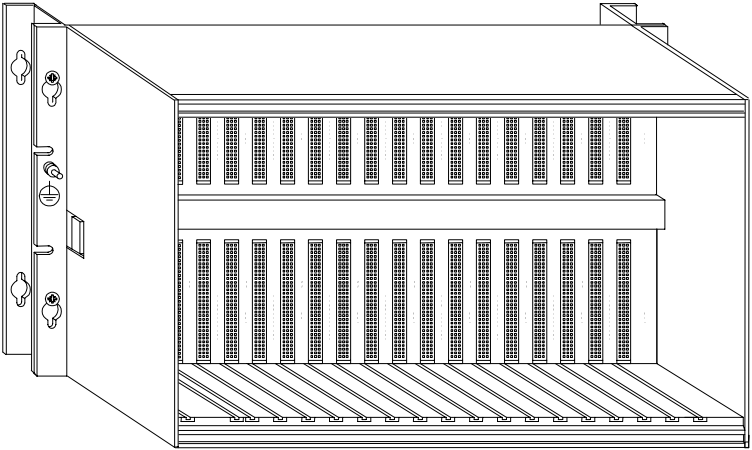

Rear Mount 9-Slot Rack (IC698CHS009)

The rear-mount rack mounts in a 10" (254 mm) deep enclosure. The rack must be mounted in the orientation shown in the following figure.

The #8-32 ground stud on the sides of the rack must be connected to earth ground as detailed in "Safety and Reference Ground" on page 3-8.

Mounting Dimensions

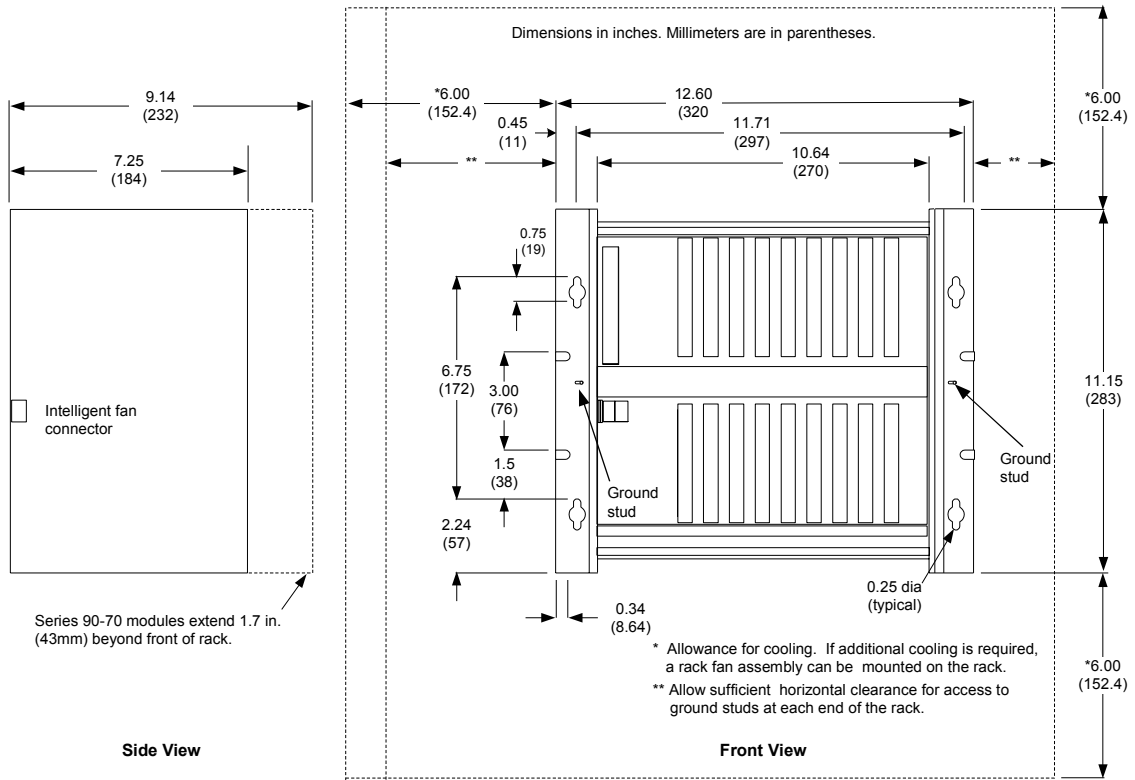

Front Mount 9-Slot Rack (IC698CHS109)

The rack must be mounted in the orientation shown in the following figure.

The #8-32 ground stud on the sides of the rack must be connected to earth ground as detailed in "Safety and Reference Ground" on page 3-8.

Mounting Dimensions

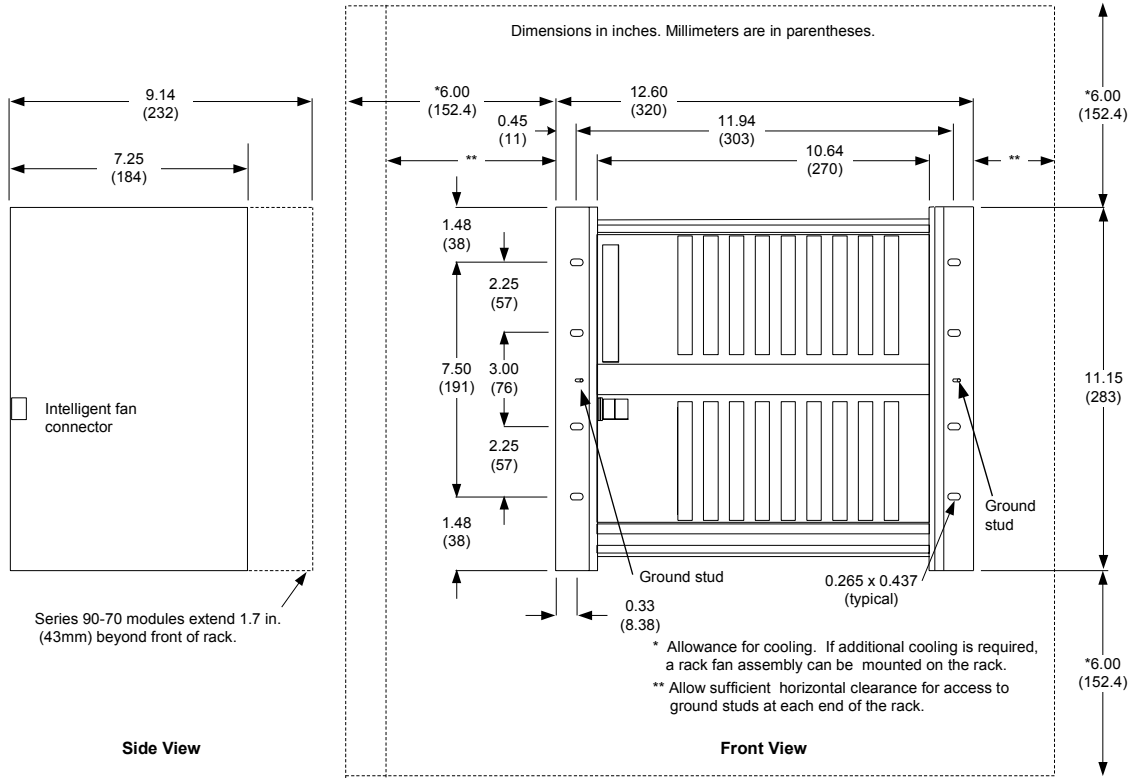

Fan Assembly

Note: It is recommended that the fans be wired to the same source of power as the CPU. This ensures that the fans are running when the CPU is active.

Note: You will need to install the fan assembly on the rack **before** installing the rack into an enclosure or equipment rack. A minimum of 23cm (9 inches) between racks is required to remove and replace an individual fan from the fan assembly.

The following fan kits are available:

For 9-Slot Racks

Rack Fan Assembly, 120 VAC	IC697ACC621
Rack Fan Assembly, 240 VAC	IC697ACC624
Rack Fan Assembly, 24 VDC	IC697ACC644

For 17-Slot Racks

Rack Fan Assembly, 120 VAC	IC697ACC721
Rack Fan Assembly, 240 VAC	IC697ACC724
Rack Fan Assembly, 24 VDC	IC697ACC744

Replacement Fans and Filter Elements

120 VAC Replacement Fans	Sinwan S109AP-11-1TB
240 VAC Replacement Fans	Sinwan S109AP-22-1TB
24 VDC Replacement Fans	Sinwan SD1238AP-24HBT
Replacement Filter Element for all Rack Fan Assemblies	Comair Rotron 554146 (5 pack)

Installing Fan Assemblies for 17-Slot Racks

AC Rack Fan Assemblies (IC697ACC721/724): The fans are wired in parallel using a cable assembly (supplied with the fan assembly) that plugs into the three fan wiring connectors. When the cable assembly is installed, the fan on the left (looking at front of rack) will have a 3-foot lead with stripped ends for connecting to the 120 or 240VAC power source.

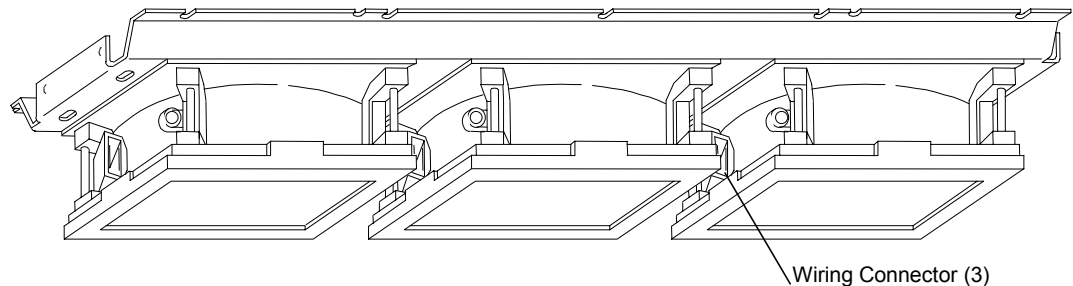

AC Rack Fan Assemblies IC697ACC721/724

24 VDC Rack Fan Assembly (IC697ACC744): For Revision B Rack Fan Assemblies and later, the power cable wiring is the same as for the AC Rack Fan Assemblies (IC697ACC721/724). For earlier versions, the fans each have a pair of 12" (310 mm), 24 AWG leads. Connect these leads in parallel, with all red leads connected to +24 VDC, and all black leads connected to 24 VDC Common. Use wire ties to fasten leads down.

Mounting the Fan Assembly on a Rack

The following illustration shows the position of the fan assembly when it is mounted on a rack. Note that it is mounted on the bottom of the rack with airflow from the bottom toward the top of the rack.

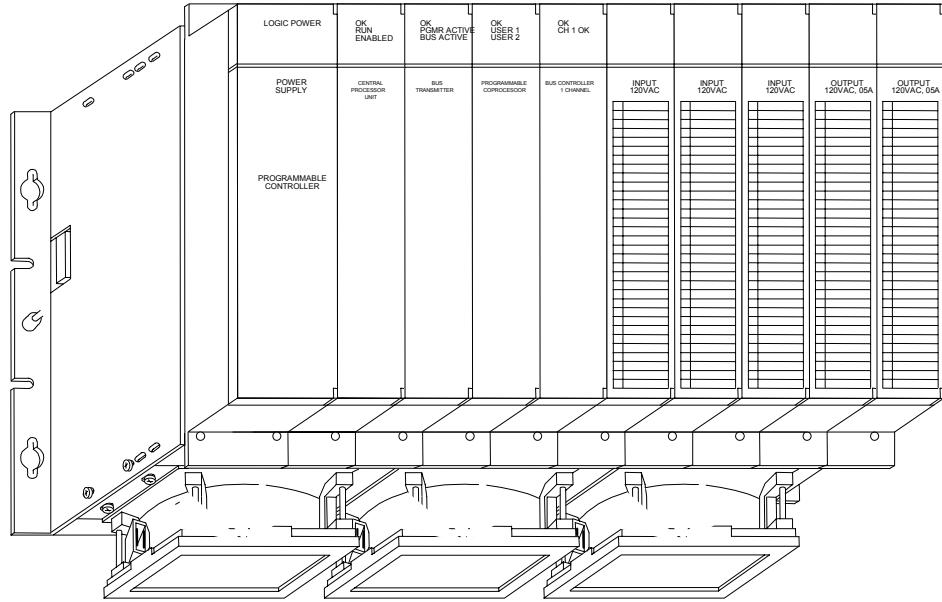

Typical Fan Assembly Mounting (AC Type Fan Assembly Shown)

To install the fan assembly, use the following instructions. *The only tool you need to attach the fan assembly to the rack is a #2 Phillips screwdriver.*

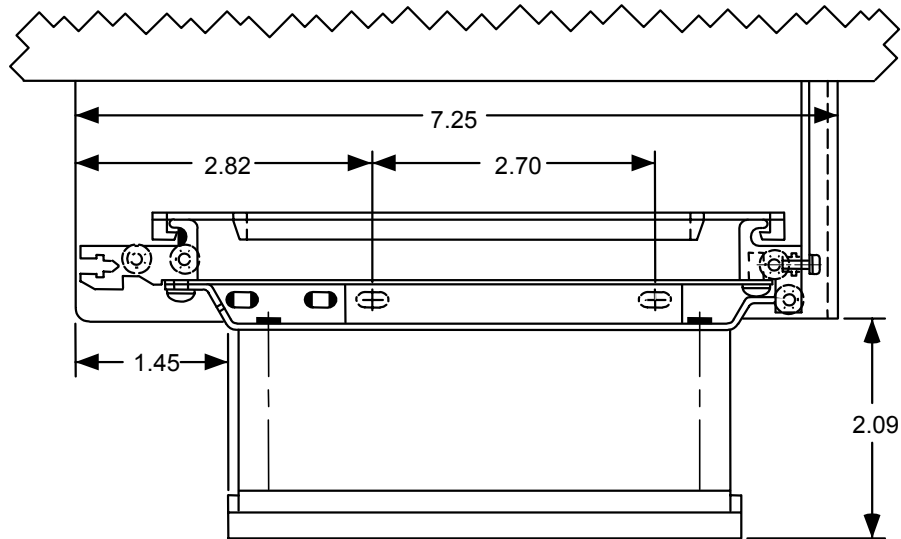

Fan Assembly Dimensions for Mounting

1. Position the fan assembly on the bottom of the rack and slide the flange on the rear of the fan assembly (flange without slots) under the lip of the rear rail on the rack.
2. While doing this, align the two holes in each end of the fan assembly with the holes in the rack side plates.
3. Install two screws in each end and secure the fan assembly by tightening the screws to 10-12 in.-lbs.
4. There are two additional screws that must be installed in the front rail. Install these screws and tighten to 10-12 in.-lbs.

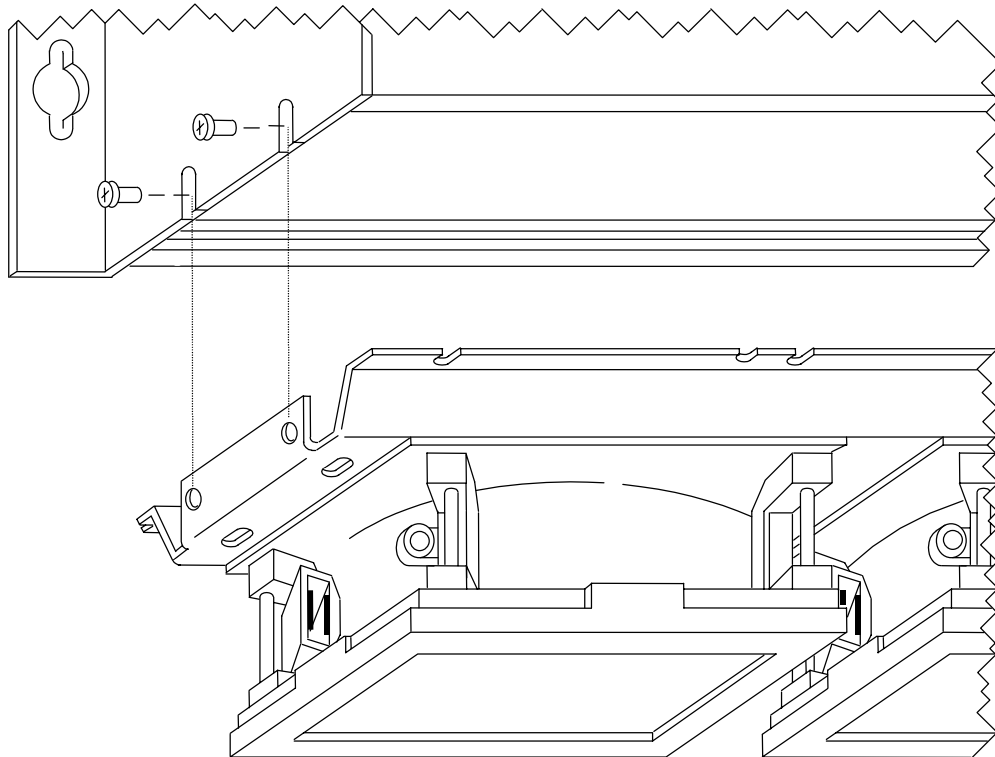

Mounting Details for Fan Assembly (AC Type Shown)

Installing Fan Assemblies for 9-Slot Racks

AC Rack Fan Assemblies (IC697ACC621/624): The two fans are wired in parallel using a cable assembly (supplied with the fan assembly) that plugs into the fan wiring connectors, located on the back of the fan assembly. When the cable assembly is installed, the fan on the right (looking at front of rack) will have a 3-foot lead with stripped ends for connecting to the 120 or 240VAC power source.

24 VDC Rack Fan Assembly (IC697ACC644): The two fans are wired in parallel using a cable assembly (supplied with the fan assembly) that plugs into the fan wiring connectors, located on the back of the fan assembly. When the cable assembly is installed, the fan on the right (looking at front of rack) will have a 3-foot lead with stripped ends for connecting to the 24 VDC power source. The red lead connects to +24 VDC and the black lead connects to 24 VDC Common. Use wire ties to fasten leads down.

Mounting the Fan Assembly on a Rack

The following illustration shows the position of the fan assembly when it is mounted on a rack. Note that it is mounted on the bottom of the rack with airflow from the bottom toward the top of the rack.

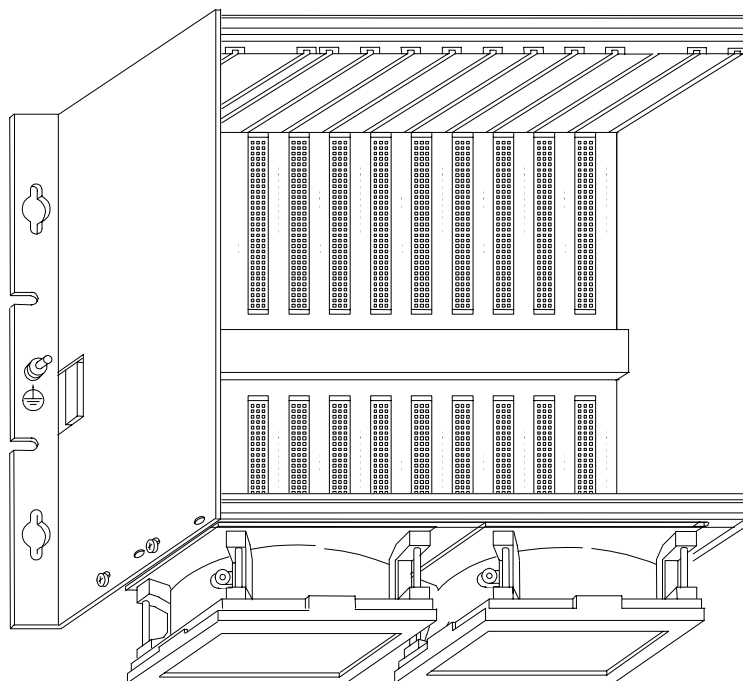

The only tool you need to attach the fan assembly to the rack is a #2 Phillips screwdriver.

Note: A minimum of 23cm (9 inches) between racks is required to remove and replace an individual fan.

1. Remove the three screws from the front, bottom panel of the rack.
2. Position the fan assembly on the bottom of the rack and slide the flange on the rear of the fan assembly (flange without slots) under the lip of the rear rail on the rack.

3. Align the two holes in each end of the fan assembly with the holes in the rack side plates.
4. Install the three screws removed in step 1 in the front of the fan assembly, securing the fan bracket to the rack. Tighten the screws to 10-12 in.-lbs.
5. Install two screws in each end. Secure the fan assembly by tightening the screws to 10-12 in.-lbs.

Changing the Fan Filters

Each fan has a polyurethane filter that can be removed, and cleaned or replaced as needed.

To remove the filter, first remove the plastic retainer by lifting the tabs located on all four sides of the retainer. Remove the filter and either clean it or replace it with a new filter.

To replace a retainer, align the retainer with the filter assembly and snap the retainer back in place. Details of the filter assembly are shown in the following figure.

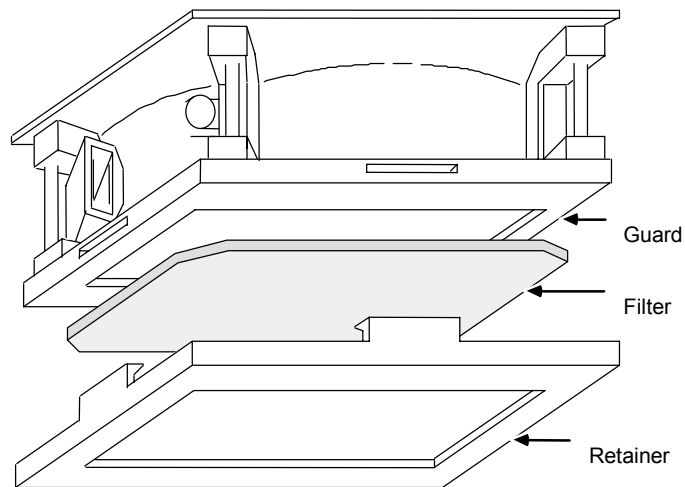

RX7i Power Supply

Warning

Even if the power supply is switched off, hazardous voltages from user field wiring may still be present on the I/O terminal boards, as well as on the power supply terminal board. Care should be taken when handling the power supply and I/O modules, as well as any wiring connected to them in order to prevent personal injury.

Replace power supply with same type and rating.

When in hazardous locations, turn off power before replacing or wiring modules.

The power supply module is installed in the leftmost slot of any standard RX7i rack.

Note: For power supply load capacities and module power requirements, refer to chapter 4.

Field Wiring Connections – AC Power Supplies (IC698PSA100 and IC698PSA350)

The AC input terminals are located on the front faceplate of the power supply. The top two terminals (L1 and L2/N) are for 120/240 VAC input. Power input connections should be made with copper AWG #16 (1.3 mm²) wire rated for 75°C (167°F). Each terminal can accept two solid or stranded wires, but the wires into any given terminal should be the same type and size. The wires should be stripped to a length of 0.25" or 7mm. Torque setting should be 12 in-lb (1.3 N-m).

It is recommended that the **GND** (ground) terminal on the power supply be connected to the GND stud on the rack and to the input power's earth ground reference using copper AWG #16 (1.3 mm²) wire rated for 75°C (167°F) to ensure adequate grounding. Use of a nut and star washer on the ground stud is recommended.

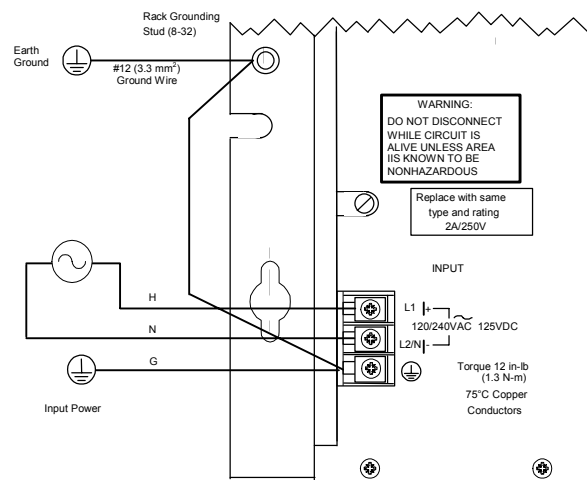

Terminal Board Connections for IC698PSA100/350

Field Wiring Connections – DC Power Supply (IC698PSD300)

The DC input terminals are located on the front faceplate of the power supply. Power input connections should be made with copper AWG #16 (1.3 mm²) wire rated for 75°C (167°F). Each terminal can accept two solid or stranded wires, but the wires into any given terminal should be the same type and size. The terminal can accept a single wire connection up to AWG #12. All wire lengths should be stripped to 0.25" (7mm). **Longer stripping lengths will result in exposed power wires which is a potential shock hazard.**

It is recommended that the **GND** (ground) terminal on the power supply be connected to the GND terminal on the rack and to earth using copper AWG #12 (3.3 mm²) wire rated for 75°C (167°F) to ensure adequate grounding. Use of a nut and star washer for each wire on the ground terminal is recommended.

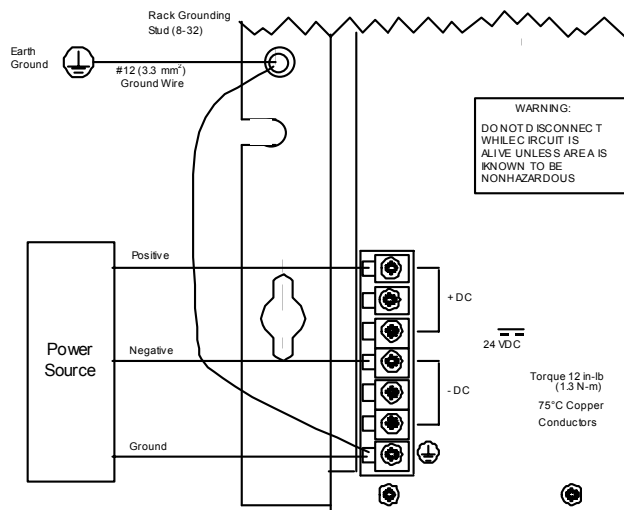

Terminal Board Connections for IC698PSD300

CPU

1. Record the 12-digit hexadecimal Medium Access Control (MAC) address from the printed label on the rear wall of the CPU battery compartment. You will need the MAC address to set the initial IP address of the Ethernet Interface so you can store a hardware configuration to the RX7i.
2. Make sure that the RX7i rack power is off.
3. Install the CPU module in slot 1 of rack 0. Press the module firmly in place, but do not force the module. Tighten the screws on the top and bottom of the CPU's faceplate.

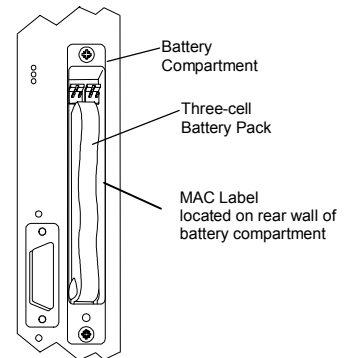

4. Connect one or both of the Ethernet network ports to the Ethernet network.
5. Turn on power. As the CPU powers up, the LEDs turn on and off in the following sequence, which corresponds to the CPU initialization process:
 - a) All LEDs are off when power is first applied.
 - b) The ENA (enable) LED is turned on.
 - c) The Run LED is turned on. (The ENA LED remains on.)
 - d) The ENA LED is turned off. (The Run LED remains on.)
 - e) The Run LED is turned off, and the OK LED is turned on.

During initialization, the EOK LED blinks and then turns on when initialization is complete. For details on verifying proper Ethernet interface powerup, temporary IP address assignment, software configuration and connecting the CPU module to an Ethernet network, refer to the *TCP/IP Ethernet Communications for the PACSystems RX7i User's Manual*, GFK-2224.

6. Connect the battery to either of the battery connectors on the module. (You can connect the battery at any step in the installation process but it will begin to drain immediately unless power is applied. To maximize battery life, it is recommended that you install it after power has been turned on).

After the program has been verified, the toggle switch can be moved to the appropriate operation mode position: RUN EN (run with outputs enabled), RUN DIS (run with outputs disabled), or STOP. The LEDs indicate the position of the toggle switch, status of serial port activity, status of Ethernet interface including Ethernet OK, LAN, STATus, activity, and 10 or 100Mbps rate used. For details on CPU operation, refer to the *PACSystems RX7i CPU Reference Manual*, GFK-2222.

Replacing the CPU Battery Pack

A three-cell lithium battery pack (IC698ACC701) is installed in the battery compartment on the front of the CPU. The battery maintains program and data memory and operates the calendar clock when power is removed.

To avoid loss of RAM memory contents, routine maintenance procedures should include scheduled replacement of the CPU's IC698ACC701 lithium battery pack. For information on estimating battery life, refer to the *PACSystems CPU Reference Manual*, GFK-2222.

To replace the battery pack:

Note: The battery can be replaced with power applied to the rack and the CPU in RUN or STOP mode.

1. Open the battery compartment door and remove the battery from the compartment without disconnecting the battery from its terminals.
2. Place the replacement battery in the compartment and connect it to the battery terminals that are not being used.
4. Disconnect the old battery from its terminal and discard the old battery.
5. Close the battery compartment door.

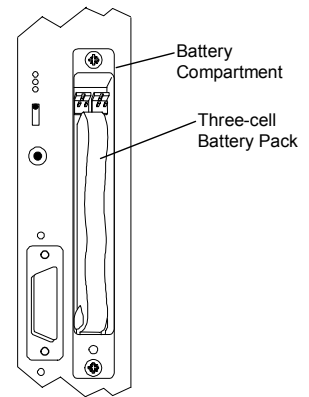

Warning

Do not re-charge, disassemble, heat or incinerate lithium batteries.

Do not make substitutions for the battery. Be sure to use the authorized part number to replace the battery.

Disposal of lithium batteries must be done in accordance with federal, state, and local regulations. Be sure to consult with the appropriate regulatory agencies before disposing of batteries.

For details, refer to the Material Safety Data Sheet provided with the battery.

Note: An external Auxiliary Battery Module, IC693ACC302 can be used to provide long-term battery backup for any PACSystems CPU. For details, refer to the datasheet for the Auxiliary Battery Module, GFK-2124.

Removing a CPU from the Rack

The instructions listed below should be followed when removing a CPU from its slot in a rack.

Warning

Do not insert or remove a module when power is applied to the rack. This could cause the system to stop, damage the module, or cause personal injury to you. Use care when inserting or removing a module so that the printed circuit board and/or its components are not damaged.

1. **Be sure the RX7i rack power is OFF.**
2. Unscrew the top and bottom mounting screws to release the board from the chassis. The screws should stay mounted in the faceplate but allow the faceplate to be separated from the chassis rails.
3. Grasp the board firmly at the top and bottom of the faceplate with your thumbs on the front of the cover and your fingers on the back of the cover.
4. Pull the board firmly to remove it from the backplane connector.
5. Slide the board along the card guide and remove it from the rack.

Ethernet Interface Module

For details on features and operation, refer to the *TCP/IP Communications for the PACSystems RX7i User's Manual*, GFK-2224, and the *Station Manager for the PACSystems RX7i user's manual*, GFK-2225.

1. Read and record the 12-digit hexadecimal MAC Address from the printed label on the side of the Ethernet Interface module. You will need the MAC address to set the initial IP address of the Ethernet Interface so you can store a hardware configuration to the PLC.
2. **Be sure the RX7i rack power is OFF.**
3. Slide the Ethernet Interface into the slot for which it was configured in the system. This is normally the first available slot to the right of the CPU.
4. Press the board firmly in place, but do not force the board. Tighten the screws on the top and bottom of the module's faceplate.
5. Connect one or both of the network ports on the Ethernet Interface to the Ethernet network.
6. Power up the RX7i rack.

For details on verifying proper powerup, assigning a temporary IP address, configuring the Ethernet Interface hardware parameters, and connecting the interface module to an Ethernet network, refer to the *TCP/IP Communications for the PACSystems RX7i User's Manual*, GFK-2224.

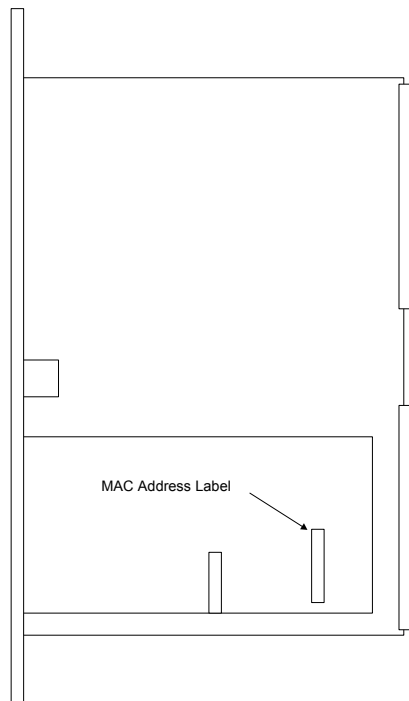

Side View of Ethernet Interface Module

I/O, Communications and Intelligent Option Modules

I/O, communications, and intelligent option modules can be installed in slots 3 and higher of the RX7i rack. (The last slot on the right is a double slot; if you install a single-width module in this slot, you will want to install a single-width filler faceplate (IC698ACC735) to cover the empty opening.)

Backplane connectors are spaced on 0.8" (20.3mm) centers to accommodate single-width RX7i and VME modules. Legacy Series 90-70 modules use two slots each.

Note: RX7i modules use faceplates fitted with an EMI gasket (a metal strip along the side of the faceplate) to ensure contact of the gasket with the faceplate of each adjacent module in the rack, forming a continuous EMI shield for the modules in the rack. (RX7i power supplies have the gasket on both sides of the faceplate.) The EMI gasket should be facing to the right when installed as one views the front of the rack. This EMI shield makes the rack less susceptible to external electrical noise and minimizes the level of electrical noise radiated by the rack. If the rack is not fully populated with gasketed faceplates, it must be installed into a metal enclosure to achieve similar noise improvement. Gasketed filler faceplates can be ordered as needed. (IC698ACC735 - single-width; IC698ACC720 -double-width).

Warning

Do not insert or remove a module when power is applied to the rack. This could cause the system to stop, damage the module, or cause personal injury to you. Use care when inserting or removing a module so that the printed circuit board and/or its components are not damaged.

Note: Integration of VME modules must be in accordance with the guidelines described in the *PACSystems RX7i User's Guide to Integration of VME Modules*, GFK-2235.

I/O Module Addressing

Module addressing is determined by the position (slot number) in the rack in which it is installed. There are no jumpers or DIP switch settings required for addressing of modules. Reference addresses for each module are assigned using the hardware configuration portion of the programming software. The hardware configuration function allows you to assign reference addresses to the I/O modules on a slot-by-slot basis.

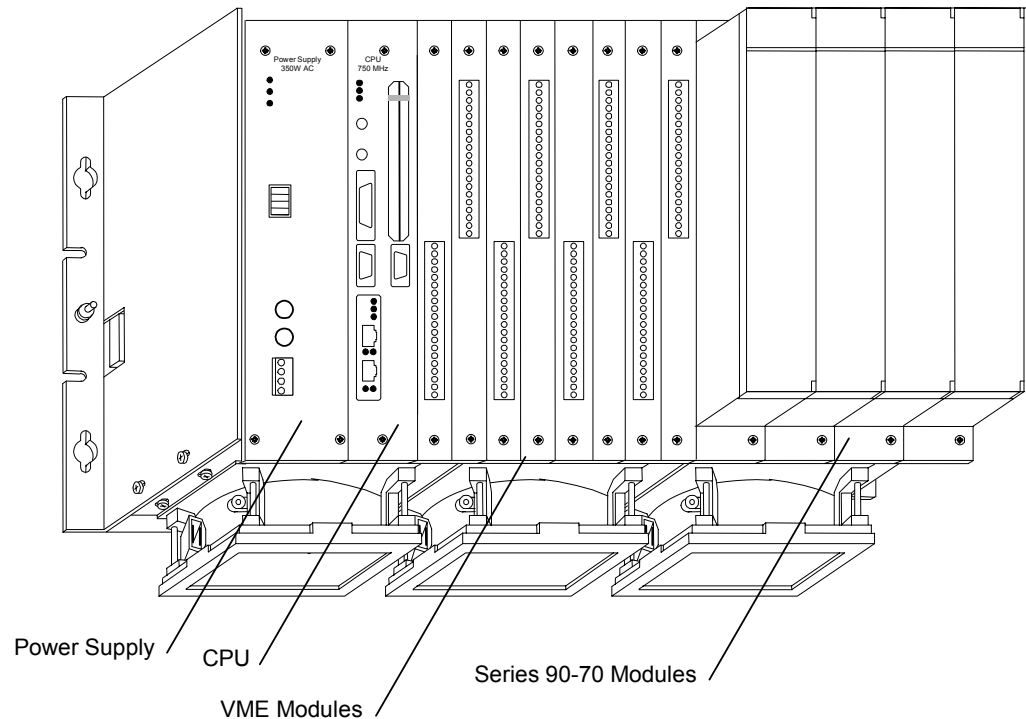

RX7i Rack with VME and Double-Width Series 90-70 Modules Installed

Single-Width Modules

1. **Be sure the power to the rack into which the module is to be inserted is OFF.**
2. Grasp the module firmly with your hand and insert it into the card guide.
3. Align the module's printed circuit board with the connector on the rack backplane and slide it towards the connector until it has started to seat.
4. Press the board firmly in place, but do not force the board. Tighten the screws on the top and bottom of the module's faceplate.

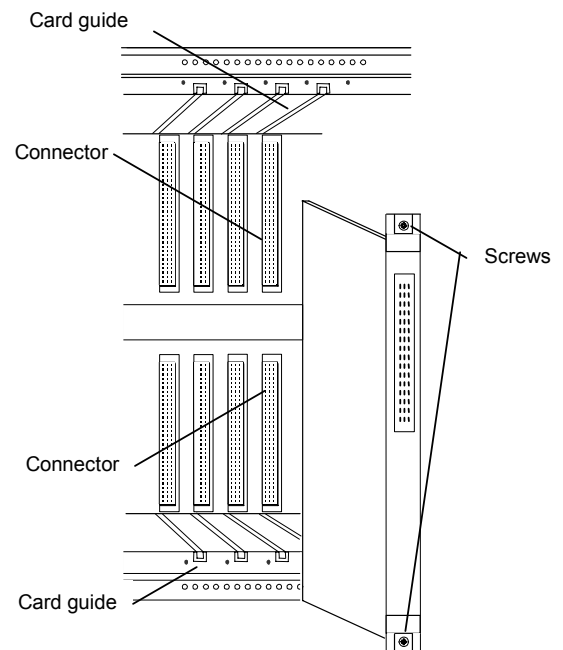

Grounding

All RX7i modules have metal faceplates that must be screwed directly to the conductive top and bottom rail of the rack to ensure the faceplate is grounded to frame ground.

Terminal Boards

Some single width I/O modules have detachable field wiring terminal connectors. This feature makes it easy to prewire field wiring to user supplied input and output devices, and to replace modules in the field without disturbing existing field wiring. The connector is supplied with integral latches. To remove the connector, depress both latches simultaneously while gently pulling connector from socket. To install the connector, align the keying rows, and press the connector into place.

For connector pin and signal assignments, and field wiring procedures, refer to the documentation for the specific module. (User's manuals are listed in "Modules Supported in RX7i" in chapter 2.)

Removing a Module

1. **Be sure the rack power is OFF.**
2. Loosen the screws that secure the module to the rack at the top and bottom of the faceplate.
3. If the module has ejection levers at the top and bottom of the module faceplate, disengage the module from the rack by pressing the levers (this is not applicable for RX7i modules as there are no ejection levers – only for 3rd party VME).
4. Slide the printed circuit board along the card guide and remove it from the rack.

Double-Width Series 90-70 Modules

The following procedure is recommended when inserting a module into its slots in a rack:

1. **Be sure the power to the rack into which the module is to be inserted is OFF.**
2. Grasp the module firmly with your hand and insert it into the card guide.
3. Align the module's printed circuit board with the connector on the rack backplane and slide it towards the connector until it has started to seat.
6. Place one thumb on the left side of the top plastic flange and the other thumb on the left side of the bottom plastic flange. Push the board into the connector until the top and bottom latches click onto the rack rails. Visually inspect the board to be sure it has seated properly.

Note: If a key block has already been installed on the rack, insert the module **without** the key block.

Grounding

Some Series 90-70 I/O modules have a ground clip that contacts the conductive bottom rail on the rack when the module is fully inserted. Shield connections in the user connectors are routed to this ground clip through conductors on the module.

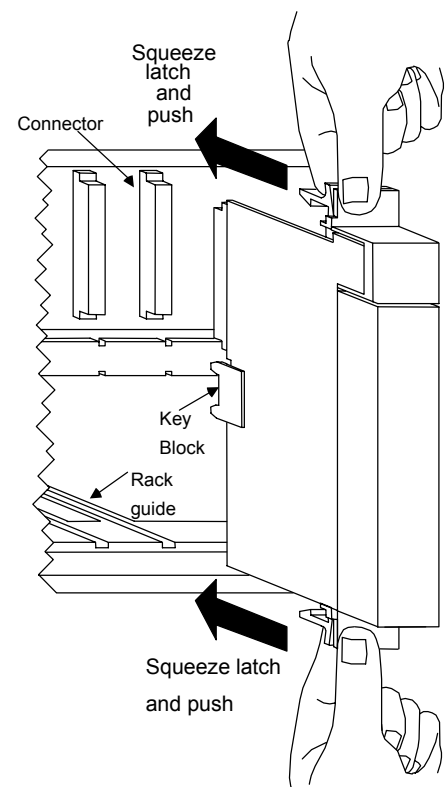

Universal Terminal Boards

Series 90-70 I/O modules have detachable field wiring terminal boards. This convenient feature makes it easy to prewire field wiring to the user supplied input and output devices, and to replace modules in the field without disturbing existing field wiring. The I/O connector terminals accept up to one AWG #14 (2.1 mm²) wire or two AWG #16 (1.3 mm²) wires. Wires are routed out of the bottom of the terminal board cavity. A terminal board strap attached to the bottom front of each I/O terminal board is used to securely fasten the terminal board to the rack. For field wiring procedures, refer to GFK-0262.

Mechanical Keying

Some double-width Series 90-70 I/O modules are mechanically interlocked by means of a key block to prevent the accidental interchange of one module type for another. For example, a DC Output module cannot be inserted into a slot where the terminal board has been wired for an AC Input module. A unique key is provided with each module. When a module is initially installed in a rack, the key block automatically latches onto the center rail on the backplane, where it remains when a module is removed. Only the correct module type can be inserted into that slot.

Installing Insulating Strips for Series 90-70 Modules

An insulator strip is required on certain Series 90-70 modules that are installed to the immediate right of an RX7i module. The insulator strip prevents module from short-circuiting to the metal faceplates of an adjacent VME module.

Note: Current versions of these modules are shipped with the insulators installed. The strip is visible on the back of the printed wiring assembly.

High Voltage Series 90-70 Modules

Insulating strips should be installed on the following modules:

	Versions earlier than
IC697MDL240	D
IC697MDL241	D
IC697MDL250	G
IC697MDL251	E
IC697MDL640	E
IC697MDL340	G
IC697MDL341	E
IC697MDL350	F

The RX7i rack is shipped with an Insulator Kit that includes enough parts to update three Series 90-70 I/O modules.

The plastic insulating strip is installed on the back of the printed wiring assembly, along the edge of the I/O connector to prevent the possibility of high voltage I/O cards short-circuiting to the metal faceplates of VME cards. (Follow the installation instructions included with the kit). Use part number 44A752213-G01 to order additional kits as needed.

Bus Controller and Bus Expansion Modules

Insulating strips should be installed on the following modules to prevent the possibility of the module short-circuiting to the metal faceplate of the adjacent VME board.

IC697BEM731	Genius Bus Controller
IC697BEM713	Bus Transmitter Module
IC697BEM711	Bus Receiver Module

The plastic insulating strip is installed on the backside of the printed wiring assembly, along the edge of the I/O connector.

To order insulating strip kits for IC697BEMxxx modules that do not have them, use part number 44A751635-G01. (Follow the installation instructions included with the kit).

Removing a Double Width Series 90-70 Module

1. **Ensure that the rack is powered down.**
2. Grasp the module firmly at the top and bottom of the board cover with your thumbs on the front of the cover and your fingers on the plastic clips on the back of the cover.
3. Squeeze the rack clips on the back of the cover with your fingers to disengage the clips from the rack rail and pull the board firmly to remove it from the backplane connector.
4. Slide the printed circuit board along the card guide and remove it from the rack.

Chapter 4

Power Supply Load Requirements

Power Supply Load Capacity

The total load of all modules in a rack must not exceed the maximum load capacity of the power supply. Refer to “Module Load Requirements” on page 4-2 for a listing of DC load required by the modules supported in an RX7i system. The maximum capacities for the power supplies are listed in the following tables.

RX7i Power Supplies

Catalog Number	Maximum Total Output (Watts)	Output Voltage (Volts)	Current (Amps)
IC698PSA350	350	+5	60
		+12	12
		-12	4
IC698PSA100	100	+5	20
		+12	2
		-12	1
IC698PSD300	300	+5	50
		+12	10
		-12	4

Series 90-70 Power Supplies

Catalog Number	Maximum Total Output (Watts)	Output Voltage (Volts)	Current (Amps)
IC697PWR710/712	55	+5	11
IC697PWR711/713	55	+5	20
		+12	2
		-12	1
IC697PWR721/722	90	+5	16.5
		+12	1.5
		-12	1
IC697PWR724	90	+5	18
		+12	1.5
		-12	1
IC697PWR731/732	60	+5	12
		+12	1.5
		-12	1
IC697PWR748	90	+5	18
		+12	1.5
		-12	1

Module Load Requirements

The following table lists the DC load (in Amps) required by each module. The total load of all modules in a rack must not exceed the maximum capacity of the power supply in the rack in which the modules are installed. For power supply load capacities, see page 4-1.

Module Load Requirements (in Amps)				
Catalog Number	Module	+5 VDC	+12 VDC	-12 VDC
IC698CPE010	300Mhz CPU	3.2	0.042	0.008
IC698CPE020/CRE020	700Mhz CPU	4.5	0.042	0.008
IC698ETM001	Rack-based Ethernet module	1.5	—	—
IC698CHS017	Rear mount rack	0.7	—	—
IC698CHS117	Front mount rack	0.7	—	—
IC698CMX016	Communications Memory Xchange	1.8	—	—
IC698RMX016	Redundancy Memory Xchange	1.8	—	—
IC697BEM713	Bus Transmitter	1.4	—	—
IC697BEM711	Bus Receiver	0.8	—	—
IC697BEM731	Genius Bus Controller, double-width	1.3	—	—
IC687BEM731	Genius Bus Controller, single-width	1.3	—	—
IC697BEM763	DLAN/DLAN+ Interface Module	1.0	—	—
IC697CMM711	Communications Coprocessor	0.7	—	—
IC697HSC700	High Speed Counter Listed current + 10mA x number of ON outputs) + (1.6 x encoder current).	1.0	—	—
IC697MDL240	120 VAC Isolated, Input, 16 points	0.25	—	—
IC697MDL241	240 VAC Isolated, Input, 16 points	0.25	—	—
IC697MDL250	120 VAC Input, 32 points	0.35	—	—
IC697MDL251	120 VAC Input, 16 points	0.35	—	—
IC697MDL252	12 VAC Input, 32 points	0.3	—	—
IC697MDL253	24 VAC Input, 32 points	0.3	—	—
IC697MDL254	48 VAC Input, 32 points	0.3	—	—
IC697MDL340	120 VAC Output, 16 point	0.25	—	—
IC697MDL341	120/240 VAC Isolated 2A Output, 16 points	0.25	—	—
IC697MDL350	120 VAC Output, 32 point	0.5	—	—
IC697MDL640	125 VDC Pos/Neg Logic Input, 16 points	0.3	—	—
IC697MDL651	Negative Logic, TTL, Input, 32 points	0.53	—	—
IC697MDL652	12 VDC Pos/Neg Logic Input, 32 points	0.3	—	—
IC697MDL653	24 VDC Pos/Neg Logic Input, 32 points	0.3	—	—
IC697MDL654	48 VDC Pos/Neg Logic Input, 32 points	0.3	—	—
IC697MDL671	Interrupt Input Module, 16 points (14 Interrupt)	0.3	—	—
IC697MDL740	24/48 VDC Output, 16 point	0.25	—	—
IC697MDL940	16 Point Output, Relay	0.75	—	—
IC697PCM711	Programmable Coprocessor	1.00	—	—
IC697VDD100	Digital Input, 64 Point	2.0	—	—
IC697VDR151	Relay Output, 64 Point	4.0	—	—
IC697VDQ120	Digital Output, 64 Point	5.1	—	—
IC697VAL264	Analog Input, 64 Channel, 16bit Standard Performance	7.0	—	—
IC697VAL132	Analog Input, Isolated, 16bit, 16 Channel, Voltage	2.5	—	—
IC697VRD008	8 Channel RTD/Strain Gauge	3.85	—	—
IC697VAL301	Analog Output, 32 Channel, 12bit	3.5	—	—

Chapter 5

Cabling Information

This chapter presents pin assignment information for the Ethernet and serial ports provided in the RX7i system.

Ethernet Ports

There are two RJ-45 Ethernet ports on the Ethernet Interface. Either or both of these ports may be attached to other Ethernet devices. Each port automatically senses the data rate (10Mbps or 100Mbps), duplex (half duplex or full duplex), and cabling arrangement (straight through or crossover) of the attached link.

Caution

The two ports on the Ethernet Interface must not be connected, directly or indirectly to the same device. The hub or switch connections in an Ethernet network must form a tree, otherwise duplication of packets may result.

10Base-T/100Base-Tx Port Pin Assignments

<i>Pin Number</i>	<i>Signal</i>	<i>Description</i>
1*	TD+	Transmit Data +
2	TD-	Transmit Data -
3	RD+	Receive Data +
4	NC	No connection
5	NC	No connection
6	RD-	Receive Data -
7	NC	No connection
8	NC	No connection

* Pin 1 is at the bottom of the connector as viewed from the front of the module.

Serial Ports

Port 1 Pin Assignments

CPU Port 1 is RS-232 compatible and optocoupler isolated. It has a 9-pin, female, D-sub connector with a standard pin out. This is a DCE (data communications equipment) port that allows a simple straight-through cable to connect to a standard AT-style RS-232 port.

Port 1 RS-232 Signals

Pin Number	Signal Name	Description
1*	NC	No Connection
2	TXD	Transmit Data
3	RXD	Receive Data
4	DSR	Data Set Ready
5	0V	Signal Ground
6	DTR	Data Terminal Ready
7	CTS	Clear To Send
8	RTS	Request to Send
9	NC	No Connection

* Pin 1 is at the bottom right of the connector as viewed from the front of the module.

Port 2 Pin Assignments

CPU Port 2 is RS-485 compatible and optocoupler isolated. Port 2 has a 15-pin, female D-sub connector. This port does not support the RS-485 to RS-232 adapter (IC690ACC901). This is a DCE port.

Port 2 RS-485 Signals

Pin No.	Signal Name	Description
1*	Shield	Cable Shield
2	NC	No Connection
3	NC	No Connection
4	NC	No Connection
5	NC	No Connection
6	RTS(A)	Differential Request to Send
7	0V	Signal Ground
8	CTS(B')	Differential Clear To Send
9	RT**	Resistor Termination
10	RD(A')**	Differential Receive Data
11	RD(B')	Differential Receive Data
12	SD(A)	Differential Send Data
13	SD(B)	Differential Send Data
14	RTS(B)	Differential Request To Send
15	CTS(A')	Differential Clear To Send

* Pin 1 is at the bottom right of the connector as viewed from the front of the module.

** Termination resistance for the RD A' signal should be connected on units at the end of the line. To make this termination, connect a jumper between pins 9 and 10 inside the 15-pin D-shell.

Station Manager Port Pin Assignments

The Station Manager ports on both the CPU and Ethernet modules are RS-232 compatible, and isolated. The Station Manager port has a 9-pin, female, D-connector. This is a DCE port that allows a simple straight-through cable to connect with a standard AT-style RS-232 port. This port contains full use of the standard RS-232 signals for future use with point-to-point protocol (PPP).

Station Manager RS-232 Signals

Pin Number	Signal Name	Description
1*	DCD	Data Carrier Detect
2	TXD	Transmit Data
3	RXD	Receive Data
4	DSR	Data Set Ready
5	0V	Signal Ground
6	DTR	Data Terminal Ready
7	CTS	Clear To Send
8	RTS	Request to Send
9	RI	Ring Indicator

* Pin 1 is at the bottom right of the connector as viewed from the front of the module.

Serial Cable Lengths and Shielding

The connection from a CPU serial port to the serial port on a computer or other serial device requires a serial cable. This connection can be made with the IC200CBL001 cable kit or you may build cables to fit the needs of your particular application.

Maximum cable lengths (the total number of feet from the CPU to the last device attached to the serial cable) are:

Port 1 (RS-232) = 15 meters (50 ft.) – shielded cable optional

Port 2 (RS-485) = 1200 meters (4000 ft.) – shielded cable required

Port 3 (RS-232) = 15 meters (50 ft.) – shielded cable optional





Appendix

A

Product Certifications and Installation Guidelines for Conformance

This appendix describes the compliance markings and standards to which the RX7i products have been certified. It also provides installation requirements for conformance to standards and additional safety guidelines for installing in the European Union.

RX7i Agency Approvals

<i>Description</i>	<i>Agency Standard or Marking</i>	<i>Comments</i>
N.A. Safety for Industrial Control Equipment		Certification by Underwriter's Laboratories to UL508 standard and equivalent CSA C22.2 No 142 - M1987 standard
N.A. Safety for Hazardous Locations Class I, Div. 2, Groups A, B, C, D		Certification by Underwriter's Laboratories to UL1604 standard and equivalent CSA C22.2 No 213-M1987 standard
Low Voltage Directive European Safety for Industrial Control Equipment		Self-Declaration in accordance with European Directives; Refer to Declaration of Conformity found under "Product Certification" at www.gefanuc.com for a list of approved products
Electromagnetic Compatibility Directive European EMC for Industrial Control Equipment		Certification by Competent Body in accordance with European Directives; Refer to Declaration of Conformity found under "Product Certification" at www.gefanuc.com for a list of approved products
Explosive Atmospheres Directive European Safety for Hazardous Locations Equipment Group II, Category 3		Certification in accordance with European Directives and Independent 3rd Party Assessment Certificate; Refer to Declaration of Conformity found under "Product Certification" at www.gefanuc.com for a list of approved products

Note: The agency approvals listed above and on the Declaration of Conformities are believed to be accurate, however a product's agency approvals should be verified by the marking on the unit itself.

UL Class 1 Division 2 Hazardous Location Requirements

The following statements are required to appear for Class I Div 2 Hazardous Locations.

1. EQUIPMENT LABELED WITH REFERENCE TO CLASS I, GROUPS A, B, C, and D, DIV. 2 HAZARDOUS LOCATIONS IS SUITABLE FOR USE IN CLASS I, DIVISION 2, GROUPS A, B, C, D OR NON-HAZARDOUS LOCATIONS ONLY.
2. WARNING – EXPLOSION HAZARD – SUBSTITUTION OF COMPONENTS MAY IMPAIR SUITABILITY FOR CLASS I, DIVISION 2.
3. WARNING – EXPLOSION HAZARD – DO NOT DISCONNECT EQUIPMENT UNLESS POWER HAS BEEN SWITCHED OFF OR THE AREA IS KNOWN TO BE NON-HAZARDOUS.

ATEX Class 1 Zone 2 Hazardous Location Requirements

In order to maintain compliance with the ATEX Directive, an RX7i system located in a Class 1 Zone 2 area (Category 3) must be installed within a protective enclosure meeting the criteria detailed below:

- IP54 or greater
- Mechanical strength to withstand an impact energy of 3.5 Joules

Standards Overview

Environmental Specifications

Standards Overview		Conditions
Vibration	IEC60068-2-6, JISC0911	10 - 57 Hz, 0.012" displacement peak-peak 57 - 500 Hz, 1.0g acceleration
Shock	IEC60068-2-27, JISC0912	15g, 11ms, sinusoidal
Operating Temperature		
IC698CPE 010		0°C to 50°C (32° to 122°F) without fan tray ¹
IC698CPE020, CRE020, CPE010, and PSA350		0°C to 60°C (32° to 140°F) with fan tray ¹
Storage Temperature		-40°C to +85°C (-40° to 185°F)
Humidity		5% to 95%, non-condensing

¹ The IC698CPE010 requires a fan tray assembly to meet the 60°C limit. IC698CPE020, IC698CRE020, IC698PSA350, and IC698PSD300 require a fan tray at all operating temperatures.

Additional RX7i Specifications

EMC Emissions		
Radiated, Conducted	CISPR 11/EN 55011 CISPR 22/EN 55022 47 CFR 15	"Industrial Scientific & Medical Equipment" (Group 1, Class A) "Information Technology Equipment" (Class A) Referred to as FCC part 15, "Radio Devices" (Class A)
Harmonic	EN61000-3-2	Class A
EMC Immunity		
Electrostatic Discharge	EN 61000-4-2¹	±8KV Air, ±4KV Contact
RF Susceptibility	EN 61000-4-3¹	10V _{rms} /m, 80Mhz to 1000Mhz, 80% AM, 1kHz sine wave
	ENV 50140/ENV 50204	10V _{rms} /m, 900 ± 5Mhz, 100% PM, 200Hz square wave
Fast Transient Burst	EN 61000-4-4¹	AC/DC Input Power: ±2kV direct Signal: ±1kV cap coupled
Voltage Surge	EN 61000-4-5¹	AC Input Power: ±2KV (12Ω) CM, ±1kV (2Ω) DM DC Input Power ² : ±0.5KV (12Ω) CM, ±0.5kV (2Ω) DM Shielded Signal ³ : ±1kV (2Ω) CM Unshielded Communication Signal ³ : ±1KV (250Ω max.) CM Unshielded I/O Signal: ±1kV (42Ω) ³ CM, ±0.5KV (42Ω) DM
Damped Oscillatory Wave	ANSI/IEEE C37.90a, EN61000-4-12¹	1Mhz, 400Hz rep rate AC/DC Input Power ² : ±2.5KV CM & DM (200Ω) Signal ³ : ±2.5KV CM (200Ω)
Conducted RF	EN 61000-4-6¹	AC/DC Input Power, Signal: 10V _{rms} , 0.15 to 80Mhz, 80%AM
Voltage Dips & Interrupts	EN 61000-4-11¹	AC Input Power: 30% Nominal (0.5 period); 60% Nominal (5,50 periods); >95% Nominal (250 periods)
Voltage Variation	EN 61000-4-11¹	AC Input Power: ±10% (50,000 periods)
Voltage Flicker	EN61000-3-3	AC Input Power: d _{max} ≤ 4%

¹ EN61000-4-x series of tests are technically equivalent to the IEC61000-4-x series.

² Not applicable to ports limited to cable lengths of 10m or less.

³ Not applicable to RS232 ports and those ports limited to 30m (98ft.) or less.

Government Regulations

U.S., Canadian, Australian, and European regulations are intended to prevent equipment from interfering with approved transmissions or with the operation of other equipment through the AC power source.

The PACSystems RX7i family of products has been tested and found to meet or exceed the requirements of U.S. (47 CFR 15), Canadian (ICES-003), Australian (AS/NZS 3548), and European (EN55022) regulations for Class A digital devices when installed in accordance with the guidelines noted in this manual. These various regulations share commonality in content and test levels with that of CISPR 22 and based on this commonality testing to the each individual standard was deemed inappropriate.

The FCC requires the following note to be published according to FCC guidelines:

Note: This equipment has been tested and found to comply with the limits for a Class A digital device, pursuant to Part 15 of the FCC Rules. These limits are designed to provide reasonable protection against harmful interference when the equipment is operated in a commercial environment. This equipment generates, uses, and can radiate radio frequency energy and, if not installed and used in accordance with the instruction manual, may cause harmful interference to radio communications. Operation of this equipment in a residential area is likely to cause harmful interference in which case user will be required to correct the interference at his own expense.

Industry Canada requires the following note to be published:

Note: This Class A digital apparatus complies with Canadian ICES-003.

Installation Guidelines for Conformance to Standards

To meet U.S., Canadian, Australian and European regulations for Class A digital devices and maintain CE Mark compliance, RX7i installations that include the following products must be installed in a metal enclosure with external wiring routed in metal conduit as described in this appendix:

- All Series 90-70 modules (For a list of supported Series 90-70 modules, see "Modules Supported in RX7i" in chapter 2.)
- All Series 90-70 expansion racks
- RX7i Memory Xchange modules (IC698RMX016, IC698CMX016)
- RX7i Rear Mount Rack with Rear I/O Access (IC698CHS217)

Requirements for Installation in a Metal Enclosure

- Racks must be mounted in a metal enclosure with a metal-on-metal connection around the door or the equivalent. All surfaces of the enclosure must be adequately grounded to adjacent surfaces to provide electrical conductivity.
- Wiring external to the enclosure must be routed in metal conduit or the equivalent. Using shielded cables and power line filtering, as detailed in "Shielded Cable Alternative to Conduit," is equivalent to using metal conduit.
- The conduit must be mounted to the enclosure using standard procedures and hardware to ensure electrical conductivity between the enclosure and conduit. The termination for the shielded cable alternative to conduit is detailed in "Shielded Cable Alternative to Conduit."

Shielded Cable Alternative to Conduit

This section describes the installation requirements for using shielded cable as an alternative to metal conduit for meeting radiated emissions requirements (EN 55022, 47CFR15, etc.). The following practices could be used in place of conduit for systems or cables that require conduit or the equivalent.

Communication Cables

All communication lines should be double-shielded. The outside braided shield (85% coverage) must be terminated at the entrance to the enclosure and not continue within the enclosure. The inside shield should be left intact since it shields the communication line from noise within the enclosure and is terminated to the connector shell. The RX7i communication port connector shells are directly tied to frame ground. To prevent ground loop currents, one cable end of the inside shield should be capacitively coupled to its shell. The outside shield is classified as an RF shield and should be insulated from the inside shield.

An alternative to double-shielded cable for Genius bus communications is Eupen* CMS cable, equivalent Genius cables with an RF-absorptive material outer coating. The shield should be terminated per standard Genius wiring guidelines.

*Telephone: 32 87 55 47 71 (Europe), 908-919-1100 (U.S.A.)

I/O Cables

All I/O lines leaving the enclosure must have at least 85% braided shield coverage terminated at the entrance to the enclosure. This 85% RF shield should not continue into the enclosure. Eighty-five percent braided shield is a standard cable available with various wire sizes and quantities from many cable manufacturers.

Analog/High Speed Cables

Analog or high-speed lines, which require shielded cable for immunity, should be double-shielded. The outside braided shield should be terminated at the entrance to the enclosure and not continue within the enclosure. The inside shield should be terminated per standard installation instructions. The outside shield is classified as an RF shield and should be insulated from the inside shield.

Power Input to Enclosure (for Series 90-70 Power Supplies)

An alternative to shielded input cables is to use RF filters to minimize the noise coupled back onto the power supply inputs. If RF filters are used at the point of enclosure entry, unshielded wires may be used inside and outside the enclosure.

AC Power Input RF Filter Requirements

- Type: Common mode/Differential mode line filter
- Effective range: between 30–300 megahertz
- Leakage current: <0.8 milliampere
- Insertion loss >30 decibels @ 30 megahertz, >20 decibels @ 100 megahertz, >15 decibels @ 300 megahertz

DC Power Input RF Filter Requirements

- Type: Feed-through, π type EMI ceramic filter
- Capacitance: 1500 picofarads (minimum)
- WVDC: 100 volts
- Current rating: As needed for application
- Insertion Loss: >50 decibels at 100 megahertz

Shield Termination

Termination of RF shields is extremely important in the reduction of RF emissions. The RF shields should be terminated at the entrance to the enclosure with a 360 degree contact between the shield and the enclosure wall.

Compression Connectors

Compression connectors are standard hardware available for the termination of conduit. The diameter of the connectors is not of significant importance other than to make sure the wires can actually fit through them. The compression connector provides a metal ring for shield termination and compression.

The following figure shows an unshielded I/O cable with a single shield (side view):

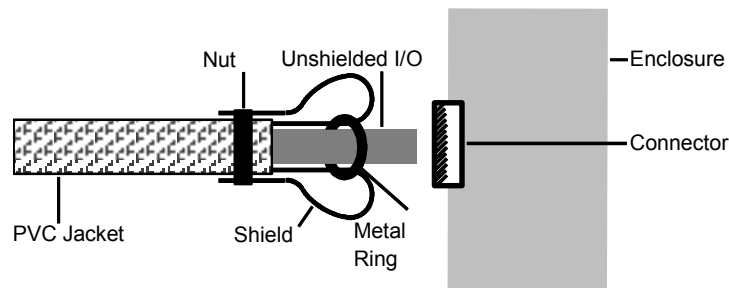

Unshielded I/O Cable with a Single Shield

The following figure shows multiple communication/high speed cables that share a single RF shield (side view):

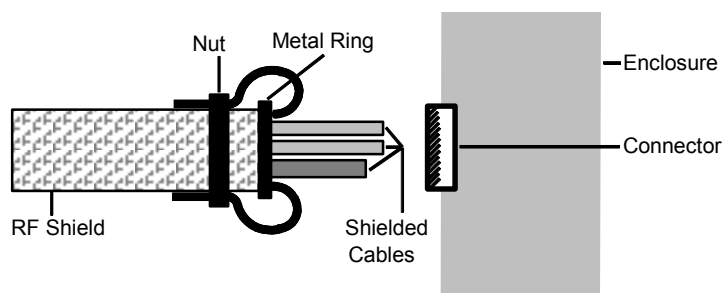

Communication Cables Sharing an RF Shield

Specialty Shielded Cable Vendors

Eupen specializes in RF-absorptive material outer coating cables (CMS cables). Ask for equivalent Genius cables.

Glenair, Inc. specializes in convoluted tubing (Series 72 & 74) and in flexible metal-core conduit (Series 75). They also carry various kinds of shield termination connectors.

Zippertubing Co. specializes in after installation zip-on shielding where different types of shielding can be selected. Recommended types of shielding are SHN-3, SH1, and SH3 to provide 85% coverage.

Safety-Related Guidelines for Installation in the European Union

This section provides safety-related guidelines specifically for control system products to be installed in the European Union. It is assumed that personnel who install, operate, and maintain automation systems that include GE Fanuc products are trained and qualified to perform those functions

1. **General:**

GE Fanuc product manuals provide information required for the intended use of GE Fanuc products. The product manuals are written for technically qualified personnel such as engineers, programmers, or maintenance specialists who have been specifically trained and are experienced in the field of automation control. Such personnel must possess the knowledge to correctly interpret and apply the safety guidelines provided in GE Fanuc product manuals. Should you require further information or face special problems that are not covered in sufficient detail in the product manuals, please contact your local GE Fanuc sales or service office or GE Fanuc authorized distributor.

2. **Qualified Personnel:**

Only qualified personnel should be allowed to specify, apply, install, operate, maintain, or perform any other function related to the products described in the product manuals. Examples of such qualified persons are defined as follows:

- System application and design engineers who are familiar with the safety concepts of automation equipment.
- Installation, startup, and service personnel who are trained to install and maintain such automation equipment.
- Operating personnel trained to operate automation equipment and trained on the specific safety issues and requirements of the particular equipment.

3. **Proper Usage:**

The equipment/system or the system components may be used only as described in the product manuals. GE Fanuc control system products have been developed, manufactured, tested, and the documentation compiled in keeping with the relevant safety standards. Handling instructions and safety guidelines described for planning, installation, proper operation and maintenance must be followed to ensure safe application and use of the products.

4. **Guidelines for the Application Planning and Installation of the Product:**

RX7i control system products generally form part of larger systems or installations. These guidelines are intended to help integrate GE Fanuc RX7i control system products into systems and installations without constituting a source of danger. The following precautions must be followed:

- Compliance with EN292-1 and EN292-2 (Safety of Machinery) as well as EN60204/IEC204 (Electrical Equipment of Industrial Machines) must be observed during the design phase.
- Opening the housing or the protective cover exposes certain parts of this equipment/system that could have a dangerously high voltage level.

- Only qualified personnel should be allowed access to this equipment/system. These persons must be knowledgeable of potential sources of danger and maintenance measures as described in the product manuals.
- Personnel must strictly adhere to applicable safety and accident prevention rules and regulations.
- A suitable isolating switch or fuses must be provided in the building wiring system. The equipment must be connected to a protective ground (PE) conductor.
- For equipment or systems with a fixed connecting cable but no isolating switch that disconnects all poles, a power socket with the grounding pin must be installed.
- Before switching on the equipment, make sure that the voltage range setting on the equipment corresponds to the local power system voltage.
- In the case of equipment operating on 24 VDC, make sure that proper electrical isolation is provided between the main supply and the 24 VDC supply. Use only power supplies that meet EN60204 (IEC204) requirements.
- The RX7i control system AC power supply must be supplied through an IEC-rated isolation transformer.
- Power supply to the RX7i control system must be controlled not to exceed overvoltage category II per EN60204-1 (IEC204).
- Do not exceed the input specifications of the power supply. Otherwise, functional failures or dangerous conditions can occur in the electronic modules/equipment.
- Emergency shutoff devices in accordance with EN60204/IEC204 must be effective in all operating modes of the automation equipment. Resetting the emergency off device must not result in any uncontrolled or undefined restart of the equipment.
- Automation equipment and its operating elements must be installed in such a manner as to prevent unintentional operation.
- Suitable measurements must be taken to ensure that operating sequences interrupted by a voltage dip or power supply failure resume proper operation when the power supply is restored. Care must be taken to ensure that dangerous operating conditions do not occur even momentarily. If necessary, the equipment must be forced into the “emergency off” state.
- Negative Logic Input and Output Modules cannot be used. (Exception: With safety agency approval, such as TÜV on GMR Systems, these devices may be used in safety system “H” configurations).
- Cable shielding and grounding are the responsibility of the machine builder. GE Fanuc’s installation instructions and guidelines must be followed.
- Install the power supply and signal cables in such a manner as to prevent inductive and capacitive interference voltages from affecting automation functions.
- When interfacing the inputs and outputs of the automation equipment, measures must be taken to prevent an undefined state from being assumed in the case of a wire break in the signal lines.

This appendix explains how to find the total heat dissipation of PACSystems RX7i equipment.

PACSystems RX7i equipment must be mounted in a protective enclosure. The enclosure must be able to properly dissipate the heat produced by all the devices mounted inside. This includes the modules, discrete output devices, and discrete input devices. Each device manufacturer publishes these values. If an exact value is not available for a device, you can make a close estimate by obtaining the value for a similar device.

Information Required

- In addition to the information in this manual, you will need the Series 90-70 Data Sheet Manual (GFK-0600) or individual module data sheets.
- You will need operating current values for the discrete output devices connected to the PLC's discrete output modules. These include control relays, motor starters, solenoids, pilot lights, etc. Each device manufacturer publishes these values. If an exact value is not available for a device, you can make a close estimate by obtaining the value for a similar device from a catalog. These values are also needed for selecting Output modules during the design process in order to ensure that the modules' maximum ratings are not exceeded.

Heat Dissipation Calculations

Module Heat Dissipation

For each module except power supplies (discussed separately), use the following procedure. Assume that all input power to these modules is dissipated as heat.

1. Look up the module in the Module Load Requirements table (chapter 4) and obtain the current values for each of the three power supply voltages listed. All modules use the 5VDC supply, and a relatively few modules also use one or both of the two 24VDC supplies.
2. For each voltage used by the module, calculate the power dissipation by multiplying the current value (in Amps) times the voltage:
$$\text{Power (in Watts)} = \text{Current (in Amps)} \times \text{Voltage (in Volts)}.$$
3. For modules using more than one voltage, add the calculated power values to arrive at the total for the module.

Example 1

The Module Load Requirements table shows that the IC698CPE020 module draws:

4.5 Amps from the +5VDC supply	22.5 Watts
0.042 Amps from the +12VDC supply	0.504 Watts
0.008 Amps from the -12VDC supply	0.096 Watts
Total	23.1 Watts

Example 2

The Module Load Requirements table shows that the IC698ETM001 module draws:

1.5 Amps from the +5VDC supply	7.5 Watts
--------------------------------	-----------

Power Supply Heat Dissipation

In general, power supplies are 66% efficient. The power supply dissipates approximately 1 Watt of power in the form of heat for every 2 Watts of power it delivers to the PLC.

After finding the total power requirement for all of the modules in the rack served by a power supply above, divide the total by 2 to find the power supply dissipation value. Do not use the rating of the power supply (such as 350 Watts) for this calculation because the application may not use the full capacity of the power supply.

Since each rack has its own power supply, each rack should be calculated on an individual basis.

Heat Dissipation for Discrete Output Modules

In addition to the module power calculations, discrete solid-state output modules require a calculation for their output circuits, which are powered from another supply. (This calculation is not required for Relay Output modules.) To calculate output circuit power dissipation:

1. In the *Series 90-70 Data Sheet Manual*, GFK-0600 (or individual module data sheet), find the value for the Output Voltage Drop for your particular module listed in the module Specifications table.
2. Using the manufacturer's documentation or other reference information, find the required current value for each device (such as a relay, pilot light, solenoid, etc.) connected to an output point on the module. Estimate the device's percent of on-time based on its intended use in the application.
3. Multiply the Output Voltage Drop times the current value times the estimated percent of on-time to arrive at average power dissipation for that output.
4. Repeat these steps for all outputs on the module, and then for all discrete output modules in the rack.

Example:

The Data Sheet for the IC697MDL340 16-Point Discrete 120 VAC Output Module lists the following information:

Output Voltage Drop: 3 Volts maximum

Use that value for all of the calculations for this module.

In this example, two of the Output module's output points drive solenoids that control the advance and retract travel of a hydraulic cylinder. The solenoid manufacturer's data sheet shows that each solenoid draws 1.0 Amp. The cylinder advances and retracts once every 60 seconds that the machine is cycling. It takes 6 seconds to advance and 6 seconds to retract.

Since the cylinder takes equal time to advance and retract, both solenoids are on for equal lengths of time: 6 seconds out of every 60 seconds, which is 10% of the time. Since both solenoids have equal current draws and on-times, a single calculation can be applied to both outputs.

Use the formula *Average Power Dissipation = Voltage Drop x Current Draw (in Amps) x Percent (expressed as a decimal) of on-time*:

$$3.0 \times 1.0 \times 0.10 = 0.3 \text{ Watts per solenoid}$$

Then multiply this result by 2 since there are two identical solenoids:

$$0.3 \text{ Watts} \times 2 \text{ Solenoids} = 0.60 \text{ Watts total for the two solenoids}$$

Also in this example, the other 14 output points on this 16-point module operate pilot lights on an operator's panel. Each pilot light requires 0.05 Amps of current. Seven of the pilot lights are on 100% of the time and seven are on an estimated 40%.

For the seven lights that are on 100% of the time:

$$3.0 \times .05 \times 1.00 = 0.15 \text{ Watts per light}$$

Then multiply this value by 7:

$$0.15 \text{ Watts} \times 7 \text{ lights} = 1.05 \text{ Watts total dissipation for the first 7 lights}$$

For the seven lights that are on 40% of the time:

$$3.0 \times .05 \times 0.40 = 0.06 \text{ Watts per light}$$

Then multiply this value by 7:

$$0.06 \text{ Watts} \times 7 \text{ lights} = 0.42 \text{ Watts total dissipation for the other 7 lights}$$

Adding up the individual calculations:

$$0.60 + 1.05 + 0.42 = 2.07 \text{ Watts for the module's total output calculation}$$

Heat Dissipation for Discrete Input Modules

In addition to the module power calculations described above, a discrete input module requires another calculation for its input circuits, because the power dissipated by the input circuits comes from a separate power source. This calculation assumes that all input circuit power delivered to these modules is dissipated as heat. The procedure is:

- In the *Series 90-70 Data Sheet Manual*, GFK-0600 (or individual module data sheet), find the value for the Input Current for your particular module listed in the module Specifications table.
- Multiply the input voltage times the current value times the estimated percent of on-time to arrive at average power dissipation for that input.
- Repeat these steps for all inputs on the module, and then for all discrete input modules in the rack.

Example

The Specifications table for the IC697MDL240 16-Point Discrete 120 VAC Input Module in the module's Data Sheet gives the following information:

Input Current: 10 mA (typical) at rated voltage)

Use this value for all of the input calculations for this module.

In this example, eight of the Input Module's points are used for switches that, for normal operation, stay on (closed) 100% of the time. These include the Emergency Stop, Over Temperature, Lube Pressure OK, and similar switches.

Use the formula *Average Power Dissipation = Input Voltage x Input Current (in Amps) x Percent (expressed as a decimal) of on-time:*

$$120 \times .010 \times 1.0 = 1.2 \text{ Watts per input}$$

Then multiply this result by 8:

$$1.2 \text{ Watts} \times 8 \text{ inputs} = 9.6 \text{ Watts total for the 8 inputs}$$

Also in this example, two input points on this 16-point module are for the Control On and Pump Start pushbuttons. Under normal conditions, these pushbuttons are only pressed once per day for about one second - just long enough to start up the control

and pump. Therefore, their effect on the power calculation is negligible and you can assume a power dissipation of zero for them:

0.0 Watts total for 2 inputs

For the remaining six inputs of this sixteen point module, it is estimated that they will be on for an average of 20% of the time. So the following calculation is made for these six inputs:

Using the formula of *Average Power Dissipation = Input Voltage x Input Current (in Amps) x Percent (expressed as a decimal) of on-time:*

$$120 \times 0.010 \times 0.20 = 0.24 \text{ Watts per input}$$

Then multiply this result by 6:

$$0.24 \text{ Watts} \times 6 \text{ inputs} = 1.44 \text{ Watts total for the 6 inputs}$$

Finally, adding up the individual calculations:

$$9.6 + 0.0 + 1.44 = 11.04 \text{ Watts for the module's total input calculation}$$

Total Heat Dissipation

Once the individual power dissipations have been calculated, add them all to obtain total heat dissipation. Note that the rack, analog input modules, and analog output modules have been ignored in this procedure because their power dissipation values are negligible when compared with the total. Also, since each rack has its own power supply, each rack should be calculated on an individual basis.

A

Agency approvals, A-1
Analog/high speed cables
 installation guidelines, conformance to standards:, A-6

B

Battery
 auxiliary, 3-24
 replacing, 3-24
Boolean execution times
 RX7i, 2-4
Bus controller/expansion modules
 insulating strips, 3-31
Bus Receiver Module, 2-21, 2-23
Bus Transmitter Module, 2-21, 2-23

C

Cables
 analog/high speed, A-6
 communication, A-6
 ground, 3-7
 I/O, A-6
 RS-485
 shielding, 5-3
 serial
 length, 5-3
Cabling, 5-1
Class I Div 2 hazardous locations, A-2
Class I Zone 2 hazardous locations, A-2
Color coding
 Wires, 3-5
CPUs
 description, 2-2
 features
 Ethernet ports, 2-3
 LEDs, 2-3
 serial ports, 2-2
 installing, 3-23
Customer care, 3-2

D

Document set
 Genius, 1-2
 RX7i, 1-1
 Series 90-70, 1-2
Double-width Series 90-70 modules
 installing, 3-29
 supported, 2-19

E

EMI gasket, 3-27
Enclosure, A-5, B-1
Equipment grounding, 3-8
Ethernet Interface module
 installing, 3-26
Ethernet ports, 5-1
European Union
 guidelines, A-9
Expansion racks
 features, 2-23, 3-1
 installing, 3-1

F

Fan assemblies
 features, 2-18
 installing, 3-16
 specifications, 2-18
Fan filters
 changing, 3-20
FCC notice, A-4
Field wiring connections
 AC power supplies, 3-21
 DC power supply, 3-22
Front mount rack
 mounting dimensions, 3-9

G

General specifications, A-3
Genius Bus Controller, 2-21
Getting started, 1-1
Government regulations, A-4
Ground conductors, 3-7
Grounding
 equipment, 3-8
 RX7i modules, 3-28
 safety and reference
 requirements, 3-8
 Series 90-70 modules, 3-29
 system, 3-7

H

Hazardous location requirements
 ATEX, A-2
 UL, A-2
Heat dissipation calculations
 information required, B-1
 input circuits, B-4
 power supplies, B-2
High Speed Counter, 2-21
High voltage Series 90-70 modules
 insulating strips, 3-30

I

- I/O cables, A-6
- I/O modules
 - addressing, 3-27
 - installing, 3-27
 - Series 90-70
 - keying, 3-30
 - supported, 2-19
 - terminal boards, 3-29
 - universal terminal boards, 3-30
- Installation guidelines, conformance to standards
 - application planning and installation*, A-9
 - communication cables, A-6
 - European Union, A-9
 - general, A-9
 - power input to enclosure, A-7
 - Proper usage, A-9
 - Qualified personnel, A-9
 - RX7i Memory Xchange modules, A-5
 - shield termination, A-7
- Insulating strips
 - high voltage Series 90-70 modules, 3-30
 - Series 90-70 bus controller/expansion modules, 3-31

K

- Keying, Series 90-70 I/O modules, 3-30

L

- Layout, PLC system
 - guidelines, 3-3
- Load requirements
 - modules, 4-2

M

- MAC address
 - embedded Ethernet Interface, 2-3, 3-23
 - ETM001, 3-26
- Metal enclosure, 3-1, A-5
- Modules
 - double width
 - removing, 3-31
 - replacement, 3-31
 - load requirements, 4-2
 - single width
 - removing, 3-29
 - replacement, 3-29
 - VME, 2-21
- Modules supported in RX7i, 2-19
- Mounting dimensions
 - front mount rack, 3-9

- rear mount rack, 3-10, 3-11

N

- Noise protection, 3-27

P

- Part numbers
 - lithium battery pack for CPU, 2-4
 - standard fan assemblies, 2-18
 - station manager cable, 2-4
- Pin assignments, 5-1
- Ports
 - Ethernet, 5-1
 - CPU, 2-3
 - serial, 5-2
 - CPU, 2-2
- Power supplies
 - features, 2-10
 - installing, 3-21
 - sharing, 2-24
- Power supply load capacity
 - RX7i, 4-1
 - Series 90-70, 4-1
- Pre-installation check, 3-2

R

- Racks, RX7i
 - features, 2-6
 - installing, 3-9
- Racks, Series 90-70
 - features, 2-23
 - installing, 3-1
- Rear mount rack
 - mounting dimensions, 3-10, 3-11
- Recommended system grounding, 3-7
- Regulations, A-4
- Related documents
 - Genius, 1-2
 - RX7i, 1-1
 - Series 90-70, 1-2
- Removable terminal boards, 3-29, 3-30
- RFI standards, A-4
- RX7i
 - control system overview, 1-3
 - document set, 1-1
 - general specifications, A-3
 - modules supported, 2-19
 - racks, installing, 3-9
- RX7i Memory Xchange modules
 - installation guidelines for conformance, A-5

S

- Safety and reference ground
 - requirements, 3-8
- Serial ports, 5-2
- Series 90-70
 - installation guidelines for conformance, A-5
- Shared power supply, 2-24
- Shielding
 - serial cable, 5-3
- Single-width modules
 - installing, 3-28
 - supported, 2-19
- Specialty shielded cable vendors, A-8
- Specifications
 - fan assemblies, 2-18
- Support, technical, 3-2
- System grounding, 3-7

T

- Technical support, 3-2
- Terminal boards
 - detachable, 3-29, 3-30
 - I/O, 3-29, 3-30

V

- VME modules, 2-21

W

- Wiring
 - Color coding, 3-5
 - Routing wires, 3-6