



CDP-244 CDP-244CRB

Instruction Manual

Personal CD Player

CD·MOBILE

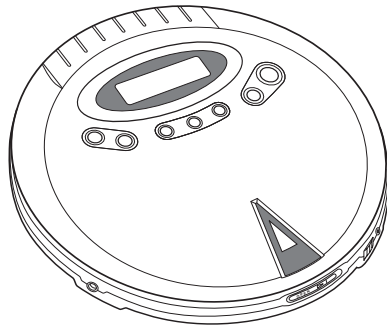

SANYO Canada Inc.

www.sanyocanada.com

SAFETY TIPS

Thank you for purchasing the SANYO CDP-244/CDP-244CRB.

The CDP-244 comes with headphones and an AC adapter.

The CDP-244CRB comes with headphones, an AC adapter, car cassette adapter and cigarette lighter adapter.

CAUTIONS FOR SAFETY

Do not take the unit apart. The laser beam used in the unit could harm your eyes.

- ❶ Do not insert pins or other objects inside the unit. This unit is equipped with a safety device which automatically turns the laser beam off when the disc compartment is opened. If a pin or other metal object should get inside the unit, however, this safety device may be deactivated.
- ❷ Do not drop the unit or subject it to strong shocks. Doing so could result in damage.

Do not place the unit in the following locations:

- ❶ Locations where the temperature is high. The cabinet may warp or the unit may otherwise be damaged if it is placed in direct sunlight, near heaters (where the temperature is 140°F/60°C or greater) or in cars with the windows closed. (In the summer, the temperature may get as high as 212°F/110°C or more.) Use the unit within a temperature range of 41°F/5°C to 95°F/35°C.
- ❷ In humid or dusty locations.
- ❸ In locations exposed to heavy vibrations.
- ❹ On unstable or tilted surfaces.

CONDENSATION

If cold water is poured into a glass, water droplets form on the outside of the glass. This is called condensation. Condensation may occur on internal operating parts of the laser pickup.

CONDENSATION OCCURS:

- ❶ When the unit is brought from the outdoors into a warm room, or if it is in a cold room which is heated quickly.
- ❷ In the summer, if the unit is moved suddenly from an air-conditioned room or car to a hot or humid location.

SHOULD CONDENSATION OCCUR:

The unit may not operate properly if condensation occurs. Wait for 1 to 2 hours (to allow the internal parts to adjust to the surrounding temperature) before using the unit.

SAFETY TIPS

LASER SAFETY

THIS SET EMPLOYS AN OPTICAL LASER BEAM SYSTEM IN THE CD MECHANISM, DESIGNED WITH BUILT-IN SAFEGUARDS. DO NOT ATTEMPT TO DISASSEMBLE. EXPOSURE TO THIS INVISIBLE LASER LIGHT BEAM MAY BE HARMFUL TO THE HUMAN EYE. THIS IS A CLASS-1 LASER PRODUCT. USE OF CONTROLS, ADJUSTMENTS OR PROCEDURES OTHER THAN THOSE SPECIFIED HEREIN, MAY RESULT IN HAZARDOUS LASER LIGHT BEAM EXPOSURE. THIS COMPACT DISC PLAYER SHOULD NOT BE ADJUSTED OR REPAIRED BY ANYONE EXCEPT QUALIFIED SERVICE PERSONNEL. THE LASER MECHANISM IN THE SET CORRESPONDS TO THE STYLUS (NEEDLE) OF A RECORD PLAYER. ALTHOUGH THIS PRODUCT USES A LASER PICK-UP LENS, IT IS COMPLETELY SAFE WHEN OPERATED ACCORDING TO DIRECTIONS.

SAFETY INSTRUCTIONS



The lightning flash and arrow head within the triangle is a warning sign alerting you of "dangerous voltage" inside the product.

CAUTION

**RISK OF ELECTRIC SHOCK
DO NOT OPEN**

CAUTION: TO REDUCE THE RISK OF ELECTRIC SHOCK, DO NOT REMOVE COVER (OR BACK). NO USER SERVICEABLE PARTS INSIDE. REFER SERVICING TO QUALIFIED SERVICE PERSONNEL.



The exclamation point within the triangle is a warning sign alerting you of important instructions accompanying the product.

WARNING: TO PREVENT FIRE OR SHOCK HAZARD, DO NOT EXPOSE THIS APPLIANCE TO RAIN OR MOISTURE.

Do not apply oil or petroleum products or solvents to any part of this set.

CAUTION:

Invisible laser radiation when open and interlocks defeated. Avoid exposure to beam.

CONTROLS

1. CD lid
2. PLAY/PAUSE button
3. STOP button
4. PROGRAM button
5. ANTI-S (anti-skip) button
6. P-MODE (Program, Repeat, Intro scan, Random play) button
7. Display screen
8. SEARCH (forward) button
9. SEARCH (backward) button
10. PHONES jack
11. OPEN latch
12. VOLUME control
13. LINE OUT jack
14. BATTERY compartment
15. DC IN 4.5V jack
16. BASS X BOOST (BassXpander) switch

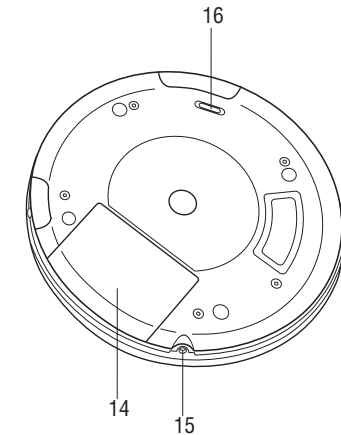
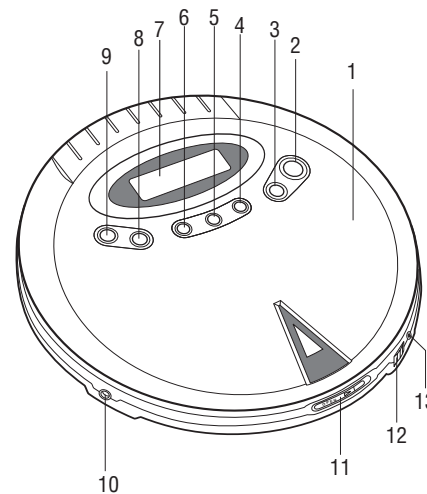

POWER SUPPLY

Plug one end of the AC adapter into the DC 4.5V jack, then plug the other end into an AC wall outlet.

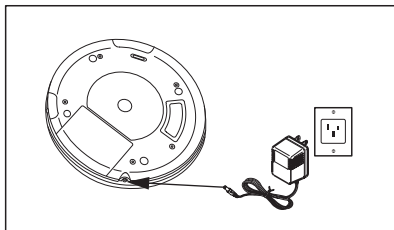

Precautions on using the AC Adapter.

- ❶ Do not touch the AC adapter with wet hands. Doing so is dangerous, as this could result in an electrical shock.
- ❷ If the AC adapter is connected when the batteries are installed, the power supply automatically switches to the AC power source and the batteries are disconnected.

ALKALINE BATTERY INSTALLATION

Insert two AA batteries (not supplied) into the battery compartment on the bottom of the unit. Be sure to observe the proper polarity (the "+" and "-" signs) as indicated inside the battery compartment.

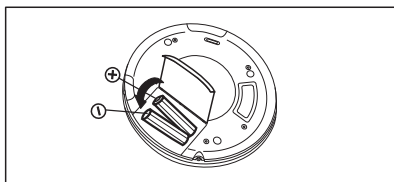



4

NOTE ON ALKALINE BATTERIES

- ❶ When replacing the alkaline batteries, use two new batteries of the same type. Do not mix a used battery with a new one or mix different types of batteries.
- ❷ When inserting the batteries, mistakenly inserting even one with improper polarity will cause leakage.
- ❸ Never charge, heat, disassemble, or throw batteries into a fire.

REMEMBER

- ❶ If the symbol "  " flashes in the display, your batteries are weak. Replace them or use the AC adapter or cigarette lighter adapter (CDP-244CRB only).
- ❷ If the display is blank — no numbers show when PLAY/PAUSE button  is pushed, the batteries are dead. Replace them, or use AC adapter. (Also check if you inserted the batteries according to the + and - as

IMPORTANT NOTE:

Spent or discharged batteries must be recycled or disposed of properly in compliance with all applicable laws. For detailed information, contact your local solid waste authority.

CAR KIT ADAPTER (FOR CDP-244CR ONLY)

- The supplied cigarette lighter adapter is designed for use with vehicles that have a 12V, negative ground electrical system.
- Most vehicles have this type of electrical system, but if you are unsure about the system in your vehicle, contact the vehicle dealer.

CIGARETTE LIGHTER ADAPTER (FOR CDP-244CRB)

Plug one end of the cigarette lighter adapter into the [DC IN 4.5V], then plug the other end into the cigarette lighter jack.

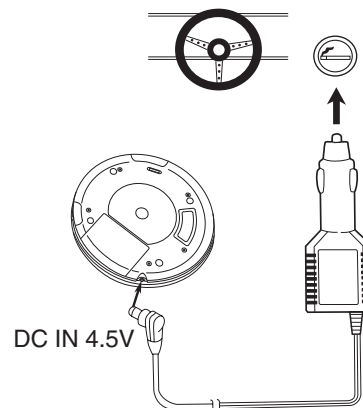

Caution on the cigarette lighter adapter.

- Use this unit only with the supplied cigarette lighter adapter. Use with other cigarette lighter adapters could damage the unit.
- When the inside of the cigarette lighter jack is dirty with ashes or dust, the plug section may become hot due to poor contact. Be sure to clean the cigarette lighter jack before use.
- After use, disconnect the cigarette lighter adapter plugs from both this unit and the cigarette lighter jack.
- The cigarette lighter adapter may cause interference with reception from the car radio or another radio inside the vehicle. If this is the case, disconnect the cigarette lighter adapter from the cigarette lighter jack, or use the radio at a distance from the cigarette lighter adapter.

5

CAR CASSETTE ADAPTER (FOR CDP-244CR ONLY)

BEFORE USE

Check the cassette tape insert slot of your car stereo. If necessary, change the direction of the cord on the cassette shaped pack of the adapter.

- There may be some car stereo types with which this car cassette adapter will not work properly.

To change the cord direction

- 1 Gently pull the cord out of the slot on the back as shown.

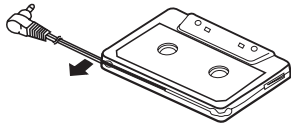

- 2 Change the cord exit location (back or either side of the pack). Push the cord back into the slot.

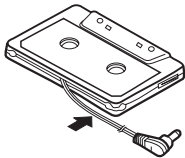

6

USING IN A CAR

- 1 Plug the cord into LINE OUT jack.
- 2 Insert the pack into the tape slot of the car stereo.

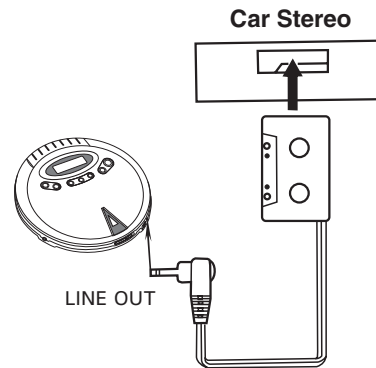

or

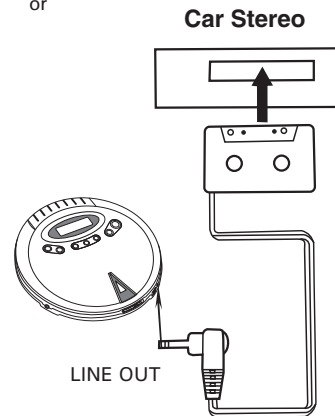

HANDLING COMPACT DISCS

This unit is designed to play compact discs bearing the identification logo (below). Discs that do not carry this logo may not conform to the CD standards and may not play properly.



Dirty, scratched or warped discs may cause skipping or noise. Pay attention to the following: Handle the disc only by the edges. To keep the disc clean, do not touch the surface of the disc.

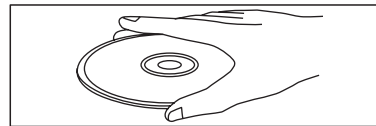

- 1 Discs should be returned to their cases after use to avoid serious scratches that could cause the laser pickup to skip.
- 2 Do not expose discs to direct sunlight, high humidity, or high temperatures for extended periods. Prolonged exposure to high temperatures can warp a disc.

- The unit will not play a disc that has been inserted upside down or discs that do not conform to the Compact Disc standard. Also, the unit might not play discs that are scratched, soiled or carry fingerprints.
- 3" (8-cm) CDs can be played without an adapter.

- 3 Do not apply paper or write anything on either side of a compact disc. Sharp writing instruments, or the inks used in some felt-tip pens, may damage the surface of the disc.

CLEANING DISCS

- 1 Fingerprints should be wiped from the surface of the disc with a soft cloth. Unlike conventional records, compact discs have no grooves to collect dust and microscopic debris, so gently wiping them with a cloth should remove most particles. Wipe in a straight motion from the inside to the outside of the disc.

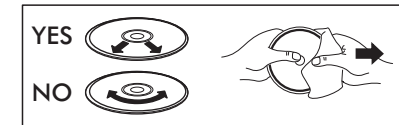

- 2 Never use chemicals such as record cleaning sprays, anti-static sprays or thinner to clean compact discs. Such chemicals can damage the disc.

7

PLAYING A DISC

Be sure to reduce the volume before plugging in or unplugging the headphones.

- 1 Plug the cord from a pair of headphones into the PHONES jack.

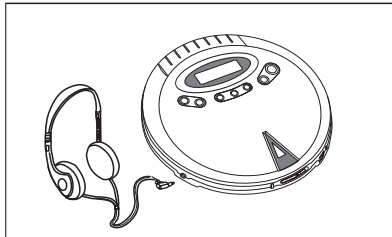

- 2 Slide the OPEN latch to release the CD lid.

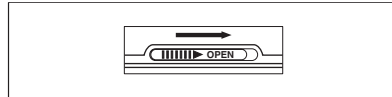

- 3 Hold the disc with the label side up and press it onto the spindle until it "clicks" into place.

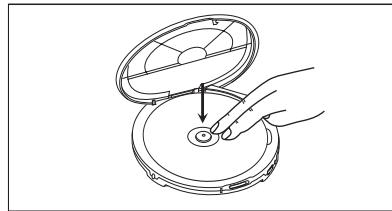

PLAYING A DISC

Close the lid and press the PLAY/PAUSE button (▶||). The disc will begin to spin, after a few seconds the display will indicate 00 and the total number of tracks and total playing time on the disc, playing will begin automatically from track number 1.

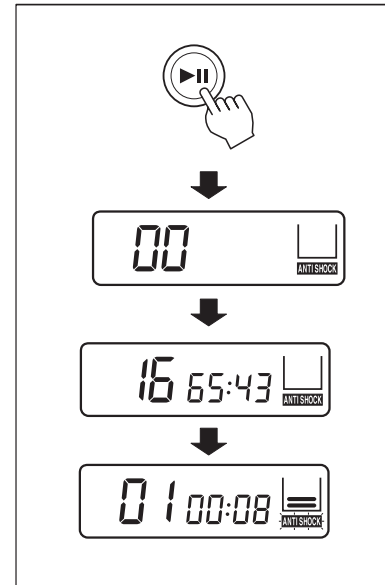

- 4 Adjust the volume.

- 5 Set the following functions as desired.
 - BASS X BOOST
 - Digital ANTI-S function

- 6 To stop play temporarily, press the ▶|| button.
 - The elapsed playing time flashes in the display.



- Press the ▶|| button again to resume.

- 7 To stop play, press the STOP button ■. Total tracks and total playing time appears in the display. Press STOP again to turn power off.

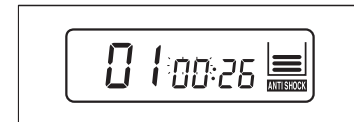

TRACK SEARCH

Press the SEARCH buttons during play to skip to the desired track.

- 1 Press the ▶▶ button to skip to the next track on the disc.
- 2 Press the ◀◀ button to start at the beginning of the track currently playing.
- 3 Press the ◀◀ button twice or more to skip to previous tracks.

PLAYING A DISC

FORWARD/BACKWARD SEARCH





Press and hold the ◀◀ or ▶▶ buttons during play to scan the disc at high speed. When the desired section of the disc is found, release the button. Normal play will resume.

- ▶▶Forward
- ◀◀Reverse

- 1 If you press and hold the ▶▶ button while playing, it will scan the track forward at high speed.
- 2 If you press and hold the ◀◀ button while playing, it will scan the track backward at high speed.

ANTI-SKIP PROTECTION

The ultimate anti-skip protection keeps the music playing under virtually any conditions. It does this by using a new quick-focus laser, rapid-access mechanism and fast-read circuitry.

- When the Anti-S button is pressed during play, the  indicator appears in the display. Digital data equivalent to 300 seconds is stored in a "read ahead" memory buffer before it is decoded and played. The  mark changes to a  mark, indicating the buffer is full.
- When the unit is subjected to a shock during play the data stored in memory continues to be decoded and played. This gives the pickup time to stabilize and continue reading new data. As the data is read from memory the indicator changes to .

- When the data buffer is filling, the disc will turn at normal speed. After the data buffer has been filled the disc will turn slower and then stop (conserving battery life). The data stored in memory continues to be decoded. After the buffer has been emptied the disc will begin to turn again.
- Press the Anti-S button to turn anti-skip protection off.

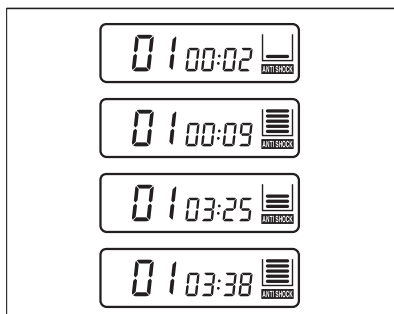

NOTE: Keep the anti-skip function off when using the unit in a stable location where it will not be subjected to shocks. The battery power consumption is reduced when skip protection function is turned off

NOTE: When ANTI-S is switched on or off, the sound will be interrupted for 1 to 2 seconds. This is normal (the interrupted time is used for the memory to switch on or off).

BASSXPANDER

BASS X PANDER

Use this function to increase the bass output.



AUTO POWER ON / OFF FUNCTION

AUTO POWER ON FUNCTION

The power turns on automatically when the ▶|| button is pressed.

AUTO POWER OFF FUNCTION

The power turns off automatically 30 seconds after all tracks on a disc have been played or the  button is pressed.

RECORDING FROM THE AUX OUT JACK

The output from the CD player can be recorded.

- Connect a patch cable (not supplied) from the AUX OUT jack on the CD player to the LINE INPUT jacks on a cassette recorder.

The sound from the CD can be heard through the speakers.

- Connect a patch cable (not supplied) from the AUX OUT jack on the CD player to the AUX or CD INPUT jacks on a stereo system.

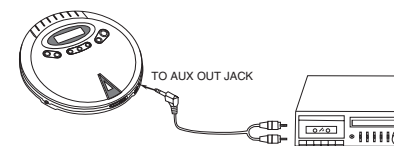

PROGRAMMED PLAY

The tracks on the disc can be programmed for play in any order. (Up to 22 tracks can be programmed.)

During programming, "PROG" flashes in the display.

- 1 Press the PROGRAM button once during play or in stop mode, "PROG" flashes in the display.



- 2 Press the ◀◀ or ▶▶ buttons to select the first track to be programmed.



- 3 Press the PROGRAM button. The first track is now stored in memory. The program number changes to "02".



- 4 Repeat steps 2 and 3 to program additional tracks.
- 5 After programming is finished, press the ▶|| button.
 - "PROG" stops flashing and programmed play begins.



- The player stops automatically after all programmed tracks have been played. The programmed tracks are stored in memory until the disc compartment is opened or power is turned off. To play the same program again, press the PROGRAM button to display "PROG", then press the ▶|| button.

SINGLE/ALL/A ↔ B TRACKS REPEAT

1. SINGLE TRACK REPEAT

Press the P-MODE button once during play, "1" appears in the display.

This plays the song over until you press the ■ button.



2. ALL TRACKS REPEAT

Press the P-MODE button twice during play, "ALL" appears in the display.

All songs will keep playing in sequence and when finished, they will start over again until you press the ■ button.



3. A ↔ B TRACKS REPEAT

Press the P-MODE button three times during play, "A ↔" appears in the display. Press PLAY/PAUSE, "B" appears and plays the tracks from A to B continuously until you press the ■ button.



INTROSCAN PLAY

- 1 Press the P-MODE button four times in stop mode or during play.
- 2 "INTRO" appears in the display. Press the ▶▶ or ◀◀ button.



RANDOM PLAY

- 1 Press the P-MODE button five times during play.



- 2 "SHUFF" appears in the display. Press ▶▶ or ◀◀, all tracks on the disc will be played once in random order.

CLEANING

CLEANING THE PICKUP LENS

Dust on the pickup lens can lead to erratic operation and interruption of the sound during play.

- To clean the pickup lens, open the disc compartment. Blow the dust off the lens using a camera lens blower (available at most camera stores). Do not touch the surface of the lens.

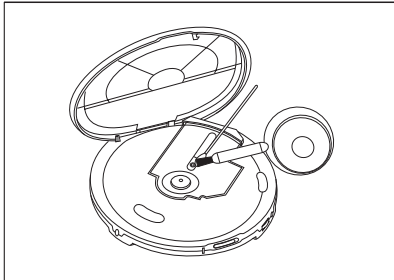

CLEANING THE CABINET

Use a soft cloth moistened with plain lukewarm water and wrung dry. Never use benzol, benzene or other strong chemical cleaners, since these could damage the finish. It is important that no liquid reaches the inside of the unit.

TROUBLE SHOOTING GUIDE

SYMPTOM	CAUSE	SOLUTION
CD Player will not turn on.	Dead or weak batteries.	Replace both batteries.
	The AC adapter is not connected properly.	Check the AC adapter connection at AC outlet and side of set.
Disc will not play.	Disc inserted incorrectly.	Re-insert disc with label side facing up.
	Defective or wrong type compact disc.	Try another audio compact disc (DVD or data disc won't work).
	CD lid not closed.	Close lid securely
	Moisture has formed inside the CD player.	Take out the CD and leave the CD lid open for about an hour to dry the moisture condensation.
No sound from headphones.	Headphone plug not inserted properly.	Re-insert headphone plug into the headphone jack.
	Headphone plugged into the AUX out jack.	Plug headphone into the headphone jack (not the line out jack).
	Volume control set to minimum.	Increase the volume.
	Weak batteries.	Replace batteries or use the AC adapter.
	Defective compact disc.	Try another compact disc.
Sound is skipping.	The compact disc or lens is dirty.	Clean or replace the compact disc or clean the lens using a camera brush/blower.
	Too much movement of the CD player.	Reduce movement of CD player.
	ANTI-S is off.	Turn on the ANTI-S.
Sound is distorted.	Music is too loud.	Decrease the volume control level.
	Weak batteries.	Replace both batteries or use the AC adapter.
	BASS X BOOST is on and music is too loud.	Lower volume or slide BASS X BOOST switch to off.
Tracks do not change or set does not play normally.	Batteries are too weak and the battery symbol will show in display.	Replace both batteries. Battery life with new alkaline batteries is about 4-8 hours of playing time.
Buttons do not work.	Electronic or static error caused circuitry to lock.	Remove batteries and AC adapter. Wait a few seconds and re-insert. Make sure batteries are fresh or adapter has power.

SPECIFICATIONS

CD PLAYER SECTION	
Frequency Response	20Hz-20kHz
Wow and Flutter	Below measurable limits
Sampling Frequency	44.1 kHz
D/A Converter	1-bit
Error Correction Method	CIRC
Pickup	Optical 3-beam semiconductor laser (780 nm wavelength)
GENERAL	
Maximum output (stereo headphones)	20mW + 20mW (32Ω)
Dimensions (Approx.) millimeter (W x H x D)	143.5mm x 27mm x 143.5mm
Weight (Approx.)	220 g
POWER SUPPLY	
DC (batteries)	3V: Using two "AA" batteries
AC adapter	Input: 120V / 60Hz Output: 4.5V/600mA

Because products are subject to continuous improvement, we reserve the right to modify product designs and specifications without notice and without incurring any obligation.

說明書確認標籤

文件名	IB01796-CD23F-45B-sanyo-E				
主控 IC	CD	sony 3009	安規		制作
	收音		<input type="checkbox"/> AC BIAS		日期 Jul.13,02
	鐘控		<input type="checkbox"/> DC BIAS		
LCD/LED 編碼					
審核	美工組		設計部		
		翻譯		工程師	

16

注：該標籤不屬於說明書內容部分
Note: The label does not belong to the text of the instruction manual.
資料來源: B40599-CD23F-45J7-Audio tech-E

THE SANYO COMFORT WARRANTY AUDIO PRODUCTS

WARRANTY APPLICATION

New, unused Sanyo Audio products purchased through a Sanyo authorized dealer in Canada are warranted against manufacturing defects in materials and workmanship for ONE YEAR from the date of purchase by the original retail purchaser. This warranty only applies in favour of the original retail purchaser of the warranted product.

SANYO CANADA INC.'S RESPONSIBILITY

During the warranty period, SANYO Canada Inc. will repair, or at our option, replace an Audio product which shows evidence of a manufacturing defect in materials or workmanship.

Replacement PARTS are warranted for the remaining portion of the warranty period.

WHAT IS NOT COVERED

- ❶ Audio products purchased outside Canada.
- ❷ Audio products purchased in a used condition.
- ❸ Problems due to product set-up and installation.
- ❹ Adjustments that are outlined in the Operating Manual
- ❺ Accessory items including antenna, batteries and cassette tapes.
- ❻ Damage in or due to transportation.
- ❼ Damage due to improper maintenance, improper wiring, accident, abuse, misuse or negligence.
- ❽ Damage caused by lightning and power surges.
- ❾ The cost of removal and reinstallation of an Audio product designed for automobile use.

ORIGINAL RETAIL PURCHASER'S RESPONSIBILITY

You, the original retail purchaser, must present your original, dated bill-of-sale together with this warranty to SANYO Canada Inc. or to an authorized Sanyo Service Depot when you make a claim under this Warranty.

You, the original retail purchaser, are responsible for any costs of TRANSPORTING the product to and from SANYO Canada Inc. or an authorized Sanyo Service Depot. You also are responsible for the cost of any MAINTENANCE necessary in respect of the product.

WARRANTY BECOMES VOID

This warranty becomes void if the product's serial numbers are altered or removed or if any repair to the product is made other than by SANYO Canada Inc. or by an authorized Sanyo Service Depot.

LIMITATIONS

- ❶ SANYO Canada Inc. Reserves the right to change or improve the design of the model of the product warranted hereunder without incurring any obligation to make any modifications to or to install any improvement in or on the product.
- ❷ In no event shall SANYO Canada Inc. or any of its Authorized Dealers be liable for special or consequential damage arising from the use of this product.

STATUTORY WARRANTIES

The above provisions do not preclude the operation of any applicable provincial statute which in certain circumstances may not allow some of the limitations and exclusions described in this Warranty. Where any terms of this Warranty are prohibited by such a statute, they shall be deemed null and void but the remainder of this warranty shall remain in effect.

HOW TO OBTAIN WARRANTY SERVICE

Please contact the Sanyo Authorized Dealer from whom the product was purchased, or contact us directly at:

SANYO Canada Inc.
1-300 Applewood Cres.
Concord, Ont. L4K 5C7
(905) 760-9944
1-800-263-2244

17