

# DVR

## Embedded Digital Video Recorder Operating Instructions



For CCTV System

Please read this user manual carefully before trying to operate this machine ,and keep it for future use.

NO.:V0.1516

---

# INDEX

<b>Chapter1 : Specifications and connector definition</b> .....	<b>Error! Bookmark not defined.</b>
1.1 System specification.....	3
1.2 DVR appearance.....	4
1.3 Connector definition.....	5
1.3.1 Front panel button definition.....	5
1.3.2 Panel key combination definition.....	5
1.3.3 Front panel <b>pilot lamp</b> definition.....	6
1.3.4 Rear panel definition.....	6
1.4 Remote controller.....	8
<b>Chapter2 : System Installation and Notes</b> .....	10
2.1 Notes.....	10
2.2 Package checking.....	11
2.3 Connection.....	12
2.3.1 Video Connection.....	12
2.3.2 Alarm input and output.....	12
2.3.3 RS-485/RS232 Connection.....	13
2.4 HDD installation.....	13
2.5 GND Connection.....	14
<b>Chapter3:Operation</b> .....	14
3.1 System operation illustration and glossary.....	14
3.2 Start system.....	15
3.3 Exit system.....	15
3.4 Status bar operation.....	16
3.5 Other operations.....	18
3.6 Main menu.....	19
3.6.1 System setting.....	<b>Error! Bookmark not defined.</b>
3.6.2 Video setting.....	21
3.6.3 Recording setting.....	23
3.6.4 Alarm setting.....	24
3.6.5 File Management.....	27
3.6.6 User Management.....	28
3.6.7 Network setting.....	29
3.6.8 Storage management.....	32
3.6.9 System info.....	33
<b>Chapter4:WAN connection instruction</b> .....	35
4.1 PPPOE.....	<b>Error! Bookmark not defined.</b>
4.2 Router setting.....	<b>Error! Bookmark not defined.</b>

**Chapter5:FAQ and Answers** ..... **Error! Bookmark not defined.**

**Appendix:** Hard disk space occupied Count table ..... **Error! Bookmark not defined.**

## Chapter1: Specifications and connector definition

### 1.1 Parameter

parameter	Model	16CH big case	4CH D1		8CH D1		16 CH small case (audio optional)
			big case	small case	big case	small case	
Video	Compression	H.264					
	Video source	PAL: 400frame NTSC: 480frame	PAL: 100 frame NTSC: 120 frame		PAL: 200 frame NTSC: 240 frame		PAL: 400 frame NTSC: 480 frame
	Live resolution	D1 (704×576)					
	Recording resolution	CIF (352×288)	D1 (704×576)		Half-D1 (704×288)		CIF (352×288)
	Input	16CH BNC	4 CH BNC		8 CH BNC		16 CH BNC
	Output	1 CH BNC, 1 CH VGA (resolution 1024×768, 60Hz)					
	Video standard	PAL、NTSC adjustable					
Audio	Audio input	16 CH	4 CH		8 CH		Audio optional
	Audio output	1 CH	1 CH		1 CH		Audio optional
	Compression	G.723					
Rec.	Recording mode	Manual, Schedule, Motion detect, alarm recording					
Storage and backup	Playback	8CH	4CH		8CH		8CH
	HDD	4X SATA HDD	4X SATA	2X SATA	4X SATA	2X SATA	2X SATA
	HDD volume	1T					
	HDD format	FAT32					
	Backup	USB device backup, network backup, Local HDD backup					
Network	Net port	Ethernet10/100Base-T , RJ45					
	protocol	UDP/IP,TCP/IP,IGMP ( multicast ), DNS&DHCP client , PPOE , DDNS					
	Net browsing method	Client software, IE browsing					
	CMS	Preview 36CH video in client software, manage 255 pcs DVR					
I/O	Alarm input	16CH	16 CH		16 CH		16 CH
	Alarm output	4 CH	4 CH		4 CH		4 CH
	RS485	1x RS485,support PTZ control					
	RS232	1 个 RS232					
	USB	1 个	1 个	2 个	1 个	2 个	2 个
Control way	Remote control	Support	Support		Support		Support
	Mouse	USB mouse					
	Panel	Support (optional)					
	Network control	Support					

3D keyboard control	Only support VC protocol 3D keyboard
---------------------	--------------------------------------

## 1.2 DVR appearance

- Black big case with button



Pic.1 Big case with button



Pic.2 Rear panel

- Big case without button ( Rear panel is same as above )



Pic.3 Big case without button

- Small case with button

















Pic.4 Small case with button



Pic.5 Rear panel

## 1.3 Connector definition



### 1.3.1 Front panel button definition:

-  **Power:** Turn ON/OFF system. If system is closed by DVR software options, you should press this button to start the system.
-  **Menu:** Enter system menu and return.
-  **Record:** Enter recording setting menu.
-  **Files:** Enter video file management menu.
-  **Mode:** witch quad ,signal picture and PIP display mode ; Long time press as the switching key of other mode, please refer to “Panel combination key definition”
-  **PTZ:** Enter PTZ control interface
-  **Page Up:** Turn up.
-  **Page Down:** Turn down.
-  **Back Space**
-  **Up:** Move up cursor.
-  **Down:** Move down cursor
-  **Right:** Move right cursor
-  **Left:** Move left cursor
-  **Enter**



### 1.3.2 Panel combination key definition



A、 ON/OFF key voice :



---

 ( Mode ) +  (Back space) : Long time press “Mode” button till you heard “DiDi” sound and then press “Backspace” button to ON or OFF key voice.

**B、 Switch video output channel :**

 ( Mode ) +  ( Up ) :Long time press “Mode” button till you heard “DiDi” sound and then press “Up” button to switch to VGA output.

 ( Mode ) +  ( Down ) : Long time press “Mode” button till you heard “DiDi” sound and then press “Up” button to switch to CVBS output

 ( Mode ) +  ( Right ) : Long time press “Mode” button till you heard “DiDi” sound and then press “Up” button to switch to digital YUV output

**Note : This mode is used to switch to LCD display on DVR all-in-one model.**

**1.3.3 Front panel pilot lamp definition:**

**PWR** : Power indicator light , It is green color when stand-by and red when work.

**HDD** : HDD work indicator light.

**REC** : Recording indicator light, it is on when DVR is recording.

**IR** : IR receiver and front panel key indicator light

**1.3.4 Rear panel**

**A、 VGA** : VGA output port, Output resolution 640x480、 800x600、 1027x768 optional.

**B、 RS232/485** : RS232/485 connector, pin definition refer to Pic.6 ( RS232/485 pin definition ) .

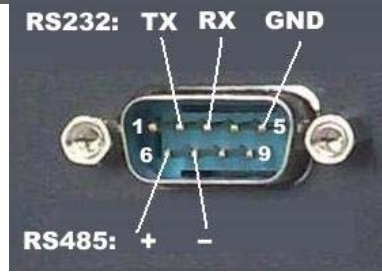

Pic.6 RS232/485 Pin definition

**C、 VIDEO**

- 1) Video In:1 ~ 16 CH CVBS Video input ;
- 2) Video Out : CVBS Video output。

**D、 AUDIO**

- 1) Audio In:1 ~ 16CH Audio input ;
- 2) Audio Out : Audio output。

**E、 LAN** : 10/100M network port。

**F、 USB** : USB2.0 port.

**G、 Alarm** : Alarm signal port :

25 pin jack in top line from left to right, the pins definition are 1, 2...13, on bottom line from left to right, the pins definition are 14, 15...25。

- 1) Alarm output ( Relay out ) : four group, they are :
  - Alarm output 1 (Relay out 1) N1D-----4
  - Alarm output 1 (Relay out 1) N1U-----17
  - Alarm output 2 (Relay out 2) N1D-----3
  - Alarm output 2 (Relay out 2) N1U-----16
  - Alarm output 3 (Relay out 3) N1D-----2
  - Alarm output 3 (Relay out 3) N1U-----15
  - Alarm output 4 (Relay out 4) N1D-----1
  - Alarm output 4 (Relay out 4) N1U-----14

Relay output 120VAC/1A 24VDC/1A , Normal ( Relay break ), alarm ( relay colse )。



2) Alarm input ( Alarm In ): 16CH alarm input pins are :

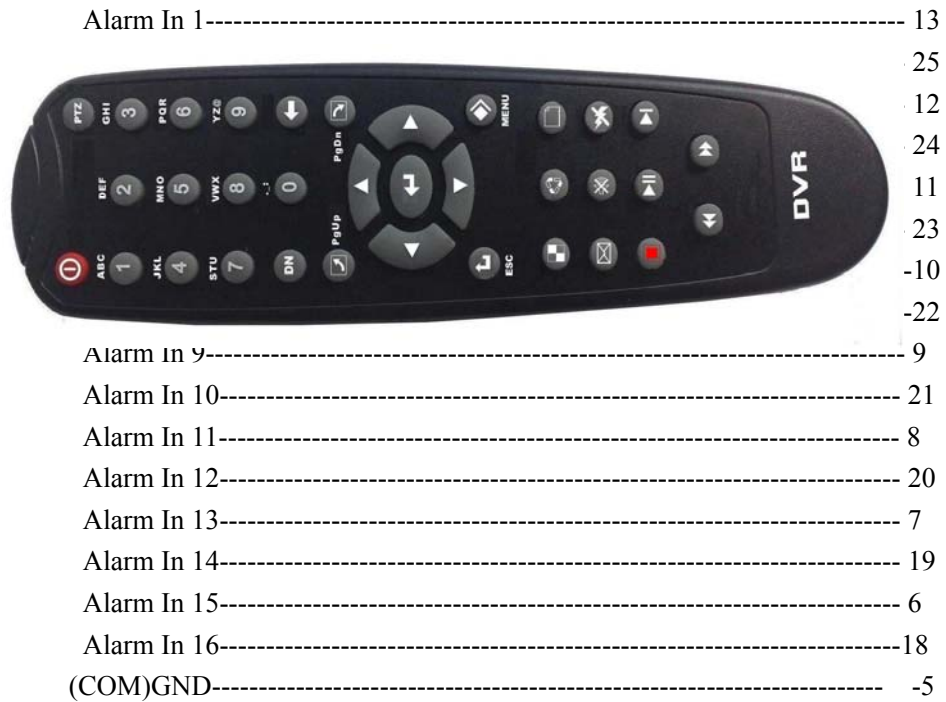

16CH alarm level input ,input impendence 22K ,window compare voltage( 3.0V to 4.18V )

**H、 Power :** Power source. , AC110V/220V , 50 ~ 60HZ。

















**I、 Power switch(I/O) :** ON/OFF system power.









**J、**  : GND

## 1.4 Remote Controller instruction







Pic.7 Remote Controller

**(1) Remote Controller key definition**

- 1 . **Figure key ( 0 ~ 9 )** : Input figure and letter. In preview model, figures 1 ~ 9 are used to switch 1-9channel.
- 2 .  **Power** : ON/OFF system power
- 3 .  **PTZ** : Enter PTZ control interface
- 4 .  **Device Number** : Enter device No. input dialog box
- 5 .  **Back Space** : Delete the current input
- 6 .  **Page Up** : Turn up, reduce the number
- 7 .  **Page Down** : Turn down, add the number
- 8 .  **Menu** : Enter main menu / return
- 9 .  **ESC** : Return, exit the operation
10.  **Mode** :Switch quad ,single picture and PIP display mode ;Long time press as the switching key of other mode; please refer to “Remote controller combination key definition”.
11.  **Shift** : Switch channel display position.
12.  **Files** : Enter video file management dialog box
13.  **Information** : Check system info
14.  **Mute** : ON/OFF system audio output
15.  **Alarm clear** : Clean system alarm prompting information
16.  **Record** : Enter recording setting dialog box
17.  **Play/Pause**

18.  **Frame Forward** : Single frame play
19.  **Speed back** : Speed back play key , there are 4 levels : 1X、 2X、 3X、 4X
20.  **Speed Forward** :Speed forward play key ,there are 4 levels:1X,2X、 3X、 4X
21.  **Up** : Cursor move up
22.  **Down** : Cursor move down
23.  **Left** : Cursor move left
24.  **Right** : Cursor move right
25.  **Enter**

**(2) Remote controller combination key definition**

- 1、  ( Mode ) +  (mute) : Long time press “**Mode**” button till you heard “**DiDi**” sound and then press “**Mute**” button to ON or OFF key voice.
- 2、  ( Mode ) + direction key ( Up, Down, Right ) : Switch output channel. Long time press “**Mode**” button till you heard “**DiDi**” sound and then press figure key to choose video output channel : Press “  ” - > CVBS output , press “  ” - >VGA output , press“  ” - >YUV output。

**Note : This mode is used to switch to LCD display on DVR all-in-one model**

## Chapter2 System Installation and Notes

### 2.1 Caution

◆ **Power supply**

※ The applicable power supply for this machine is AC100 ~ 240V 50 ~ 60Hz or 12VDC/4A, Please use our special power supply come with the machine.

※ Please keep the power plug away from socket if you don't use this machine for long time.

◆ **Safety**

※ As indoor equipment, this machine shouldn't be put in moist or dusty place. In order to prevent from danger of short circuit and electric shock.

※ Once any solid or liquid come into the machine, please cut off power immediately, And then ask the technician to inspect it before you use it again.

※ If there is any malfunction with the machine, you should ask the technician to examine and repair or contact with the dealer, please don't ever mend it by your self.

◆ **Installation place**

※ You should select the right place where the air can circulate over the machine, thus can prevent the machine from overheating.

※ This machine shouldn't be installed in hot places near radiator or vent-pipe, or some other places where is insulated or dusty and moist, as well as those places with strong magnetic field or with mechanical shake and strike.

◆ **Copyright protection**

※ Please don't infringe the related right of the third party when you make image recording program.

※ Any change or modification on this machine without our permission might destroy the machine and cause many inconvenience to the user.

## 2.2 Package checking

After unpack the carton, please check whether the host and spare parts are in good condition, if anything wrong, please stop using and contact your supplier immediately. Also please check whether the following items are complete:

- ◆ User manual X 1pcs
- ◆ IR remoter X 1pcs
- ◆ Remoter batteries X 2pcs
- ◆ QC Certificate X 1pcs
- ◆ After sales guarantee card X 1pcs
- ◆ HDD cable: SATA HDD cable X several
- ◆ AC power cable X 1pcs
- ◆ HDD bracket and screws X 1set
- ◆ Client manager software CD X 1pcs
  
- ◆ 9pin COM portconnector X 1PCS
- ◆ 25pin alarm port connector X 1PCS
- ◆ USB mouse x 1pcs

## 2.3 Connection

### 2.3.1 Video connection

#### A、 Video input connection :

System support 16CH CVBS input, input resistance is  $75\Omega$  , BNC connector.

#### B、 Video output connection :

- a) System support 1CH CVBS output , output resistance is  $75\Omega$  , BNC connector.
- b) System support 1CH VGA output , resolution 1024x768 60Hz / 800x600 60Hz / 640x480 60Hz optional.

**Note: When VGA and CVBS output connected , system can only support one connection, otherwise the video output will be abnormal caused by load resistance mismatch..**

### 2.3.2 Alarm input and output

#### A、 Sensor connection :

- a) Sensor adopt N.C. output contact

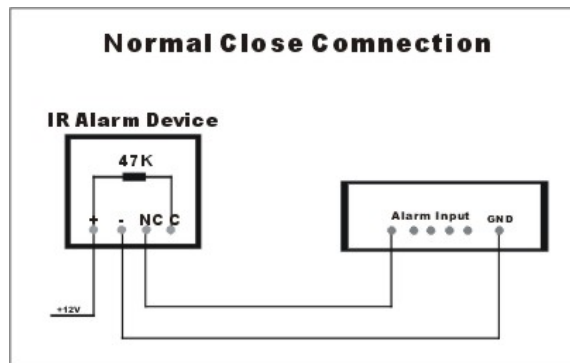

Alarm input connection1-N.C.

- b)Sensor adopt N.O. output contact

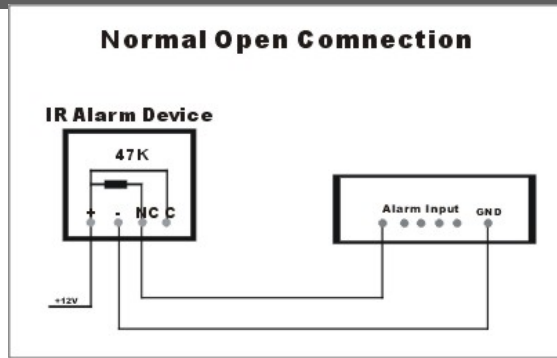

Alarm input connection 1-N.O.

**B、 Alarm output connection :**

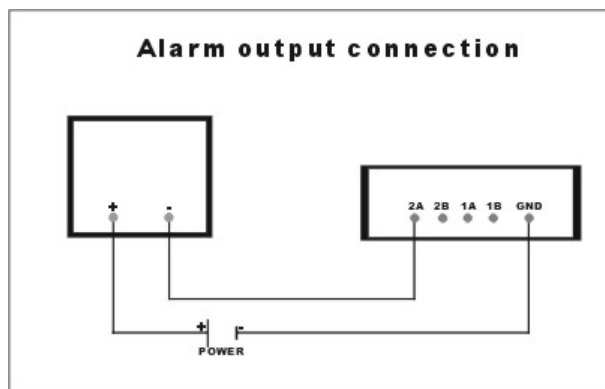

Alarm output connection

**2.3.3 RS-485/RS485 connection**

Host have one standard RS-485/232 port, pin definition please refer to Pic.3. RS485 is used to control PTZ decoder and camera, RS232 is used to debugging software and other communications expanding.

Host builds in many PTZ/camera protocols, it can connect 4 PTZ decoders/cameras at the same time, and each channel corresponds to one. Default PTZ decoder/camera decoder is same as its channel number.

**2.4 HDD installation**

System only supports 4pcs SATA HDD , and set the jumper on SATA I ( Limit to 1.5Gb/s

Operation ) mode. After that, use bracket to fix the HDD in the DVR, connect the power cable and date cable.



---

## 2.5 GND connection

After connect the signal cable, please connect the  screw with the grand to protect the host.

# Chapter3 Operation

## 3.1 System operation illustration and glossary

- 1) Selection box :   
Used to point the checked operation, yellow frame, and press direction key to move it.
- 2) Checked : The position of selection box is the current operation position. Move the box to every target means check this item.
- 3) Click : After checked the items, press “OK” button to click this object.
- 4) Soft keyboard : Checked edition box, press “OK” button to pop-up soft keyboard. You can do input work via this keyboard.
- 5) Clink : Such as ENTER,  etc .“clink” this button to realize “Confirm”、 “Cancel” and “enter next page” function.
- 6) Edit box : used to input figure、 letter etc, it include text input box and figure input box.

Text input box : Select the text input box, such as the "host name" amendment etc. Input the text in Software or the figure on IR remoter.

Figure input box : Such as time set, host No. set etc. Input the text in Software or the figure on IR

remoter. Also support page up “

- 7) Drop-down box  : choose and press “OK” to confirm it.
- 11) Radio button  : Make a mutually exclusive choice in same list or group.
- 12) Soft keyboard : press “OK” button in edit box to pop-op soft keyboard.

## 3.2 Start-up

- 1) **Start system** : Insert 12V adapter output connector into DVR power port, set the power switch(on back panel) on “ON” position, now the PWR indicator on front panel is light, when its color is green, system is stand-by (default working status).Press the power key “

## 3.3 Exit system

- 1) **Normal shutdown** : When system is in working status, press the power key “

---

15

---



the IR remoter, system will be forced shutdown.

### 3.4 Status bar operation

When system running, exit the operation interface and main interface, the status bar will display in the bottom left corner. It will show the system mute audio monitor and login status, also include system info query/ alarm/backup and system clock, as below



Pic.11 Status Bar



: Start menu button, press it to bob up start menu.



: Mute ON/OFF button





: Video/Audio monitoring status and display mode option



: Login/Lock button



: System info button, When alarm incident occurred show alarm status button : “

When system backup the data in the background show “

: Time and date setting button

#### 1) Display/Hide

In preview status, press any key to display status bar. Press return “

#### 2) Mute

Pitch on “Mute” icon, press “OK”, system will mute “

#### 3) Video/Audio monitoring status and display mode option

Pitch on monitoring select box, directly input the channel No. to switch to this channel and display in

single picture; press pageup “

to switch display mode: 16CH - >9CH - >8CH - >6CH - >Quad - >Single - >PIP - > cycle

#### 4) Login/Lock

After start system, system is in lock status, and the user can only switch the channel and display mode in panel and IR remoter. If you want to do other operation, you should login system and after that, you can do relevant operation in authorities.

**a) System Login**

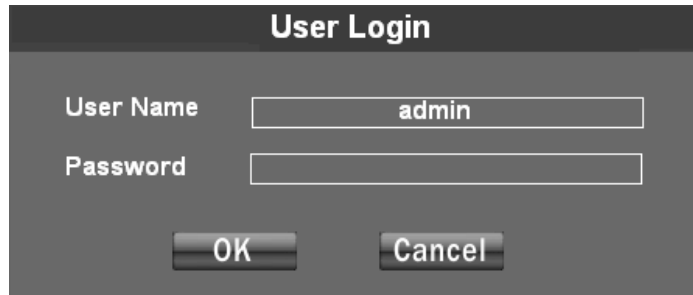

On status bar, move the cursor to LOGIN/LOCK icon  , press “OK” to pop-up login dialog box, as below. Input the user name and password and press “OK” to enter login status, the LOGIN/LOCK icon will change into login status icon .

When system is locked, any operation that needs to be authorized will trigger pop-up login dialog box. Now the user should login system and then continue his operation. ( **Note : no password in new DVR )**





Pic.12 User Login

**b) System Lock**

On status bar, move the cursor to LOGIN/LOCK icon  , press “OK” to turn into lock status  .In login status, if user do not do any operation in 2 minutes, the system will turn into lock status automatically.

**5) SYSTEM INFO**

On status bar, move the cursor to system info icon  , press “OK” to pop-up the system information checking dialog box.(Refer to “System info” chapter).

When alarm occurred, the system info icon will change into alarm prompt button icon  , press this button to pop-up alarm information query dialog box. (Refer to “System info”/“alarm query” chapter).

When system is doing backup in background , the system info icon will change into backup prompt button icon  , press this button to pop-up the backup prompt information.

**6) Time and date setting**

Move the cursor to time setting button  to pop-up system time setting

dialog box. (Refer to “System info”/“time setting” chapter)

### 3.5 Other operations





#### 1) Host number operation:

- a) **Start system** : If the system had been set the host No., that's to say the host No. is not 0, when you want to start system, the host No. should match. Detailed start method please refer to “Start system”/“Start system when the host No. is not 0”.
- b) **Match IR remoter** : If the system have the host No., that's to say the host No. is not 0, when the IR remoter control this DVR after it operated other host (not 0 host number), you should do IR remoter match and then you can control this DVR by that remoter .The match purpose is to control several hosts in one IR remoter. Match method: : Press host No., the system will pop-up host No. match dialog box after “DIDI” two sound, as follow: Input the host number in “**Input host No.( 0 ~ 99 )**”edit box and press “**OK**” to confirm. Please refer to the oval box in the picture.



Pic.13 Host No





#### 2) Video output channel switch

- a) **Front panel operation** : Long time press mode button“” till you heard “DIDI” two sound, and then press up button“”to choose VGA output, or press down button “” to choose CVBS output.
- b) **IR remoter operation** : Long time press mode button“” , till you heard “DIDI” two sound, and then press figure key to choose video output channel : 1 - >CVBS output , 2 - >VGA output , 3 - >YUV output.

#### 3) Storage device format

Enter “Main menu”/“Storage management” , pitch on the device that need to be formatted, press backspace button“” to format the chosen device. After the format, the file format is FAT32.

4) ON/OFF key voice :

- a) IR remoter operation :Long time press mode button“”till you heard “DIDI” two sound, and then press mute button “” to turn on or turn off the key voice.
- b) Panel operation :Long time press mode button “” ,till you heard “DIDI” two sound, and then press backspace button “” to turn on or turn off the key voice.

### 3.6 Main menu

Press menu button to enter main menu interface, pitch on the relevant icon button and press “OK” to enter the corresponding menu item.



Pic.14 Main Menu

#### 3.6.1. System Set

In “System Set” page, you can set the host name, host number and language. In its sub-menu, you can set system time, recover the factory settings and upgrade the system software.



Pic.15 System Set

- 1) Name : input and amend host name
- 2) Number : Amend the local host number
- 3) Language : choose the system language
- 4) Time set : Presses “Time Set” button to pop-up the time setup dialog. As below:



Pic.16 Time Set

- 5) FACT.SET: press “FACT. Set” button to pop-up the “recover factory set” dialog. As below:



Pic.17 Recover Factory Set

After recover factory set, the host number, video format, recording setting parameter etc. will not change.

- 6) **Upgrade** :Copy the system upgrade file( \*.bif )to your Flash disk, and insert it into USB port of DVR, press “upgrade” button to pop-up “Search upgrade file” dialog as below: Choose the right upgrade file, press confirm button to pop-up “Upgrade Confirm” dialog. The process of upgrading will last about 1 minute and the system will automatically restart, after the completion of the upgrade system.

**NOTE : You can not cut off the power when upgrading, otherwise the DVR system will collapse.**



Pic.18 Search Upgrade File

### 3.6.2 VIDEO SET

Set the system video properties, include the output channel, video format, PIP property, video cycle parameter, video channel title, video color parameter ect.

VIDEO SET menu as below:

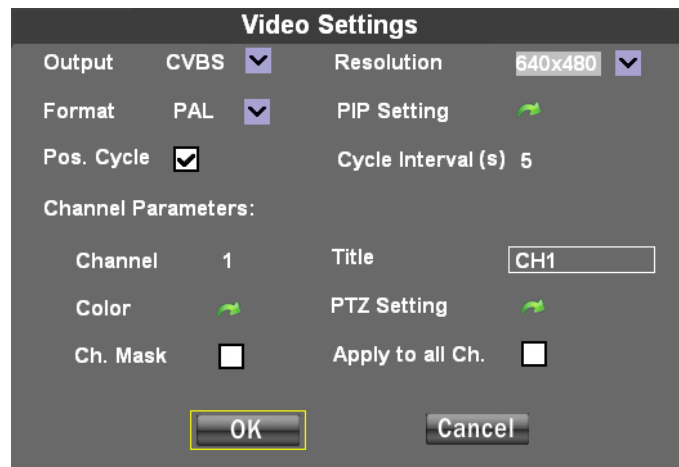

Pic.19 VIDEO SET

- 1) **Video Output** :choose output port “CVBS” ,press “PGUP” or “PGDW” to choose

**CVBS、VGA、YUV three output Way.**

If CVBS output, the resolution bar will be gray, that means disable.

If VGA output , the resolution can be : 640x480、800x600、1024x768

If YUV output , the resolution can be : 640x480、800x600、1024x768。

YUV output is digital video output way, it is used to drive digital LCD screen directly.

If you change the output way, the system need to be restart to enable it.

**2 ) VIDEO FROMAT :**

You can choose PAL or NTSC as your system format. If you change the system format, system will be restarted

**3 ) PIP setting:**

Choosing the corresponding channel, when set the PIP, this channel will displayed on the top of the screen.

**4 ) POS.CYCLE :**

Enable image cycle, choose cycle interval, the picture will automatically be cycle displayed in selected time.

**5 ) Channel parameter :**

- a) **Channel number** : To select the appropriate channel ( 1 ~ 16 )
- b) **Channel title** : Amend channel title
- c) **Color parameter** : To adjust the appropriate channel color parameter(Brightness、 contrast、 chroma 、 saturation) , press color parameter amendment button to enter color parameter amendment page, as below:



Pic.20 Progress bar

Press left or right button to adjust parameter values, press UP or DOWN button to switch parameter type, press PGUP or PGDW to switch channel

- d) **CH MASK** : Select to shield this channel
- e) **PTZ setting** : Enter PTZ setting interface

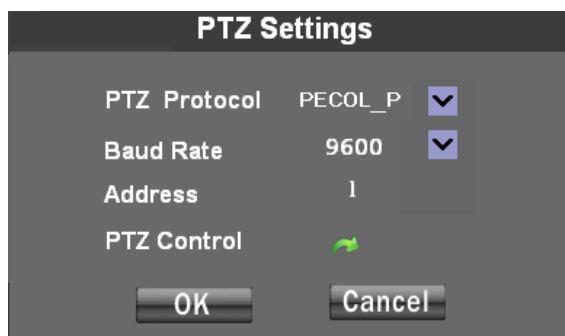

Pic.21 PTZ SET

**PTZ SET** :In this page, you can choose protocol of PTZ which associate with this channel, the baud rate and PTZ ID code. Default PTZ ID code is same as the number of channel that the PTZ associated with.

**PTZ CTRL** : Press this button to enter PTZ control interface. You can control it via operation panel. In this interface, you can set and call the preset point, can control the PTZ UP/DOWN/LEFT/RIGHT run, can control the zoom, focus and aperture ,can control the PTZ cruising.

- f) **Apply to all CH.** : choose this item and press confirm, you can copy this channel setting to others channel.

### 3.6.3 RECORD SET

Set the recording bit stream、 record mode etc

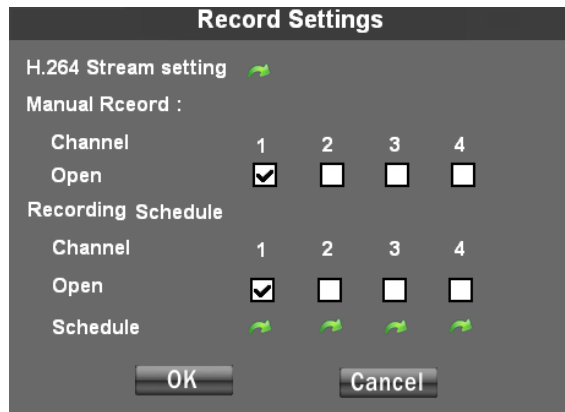

Pic.22 Record Setting

**Recording mode choose** : You can choose Manual recording, Timing recording and Alarm recording

**a) Manual recording :**

After choose the channel, this channel will start to recording under scheduled parameters (refer to recording parameter setting), and you should manual stop the recording if you need to, the method is to anti-election and confirm it.

**b) Schedule Recording**

First you should set the recording time period and then turn on this channel recording. When in scheduled time period, the system will start recording automatically till the time period over.

Time period setting: press relevant channel time period setting button to enter setting page.

Please be noted that the time period can not be in two days.



c) **Alarm recording** : Refer to alarm setting

2) **Bit stream parameter setting : setting interface as below.**

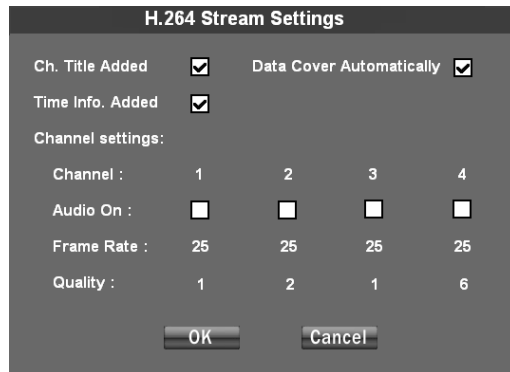

Pic.23 Stream setting

- a) **CH title Added** : Add the channel title into bit rate, so that the recording file and long range preview picture will have channel title information.
- b) **Time Info. Add** : Add the time into bit rate, so that the recording file and long range preview
- c) picture will have time information.
- d) **Data Cover Automatically** : When HDD is full, new recording file will automatically cover old files from beginning.
- e) **Add audio** : Video and audio recording simultaneously, can remote monitoring voice.
- f) **Frame rate setting** : you can set recording frame rate , PAL format from 1 ~ 25FPS optional, NTSC format from 1 ~ 30FPS optional.
- g) **Image quality level** : There are 6 level image quality.1 is best , 6 is worst. The higher level of image quality, the greater the stream. The more clear image, the greater the share of network bandwidth and disk space.

### 3.6.4 Alarm set

Set the host alarm trigger channel and relevant trigger condition, setting interface as below:  
include “motion ” and “sensor” setup :

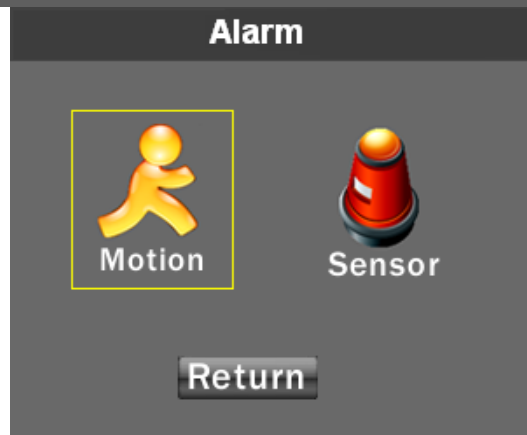

Pic.24 Alarm set

● **Motion :**

Set video lost alarm, motion detection alarm trigger condition and associated channel. Setting interface as below :



图 25 Video Detect

- a) **Channel No. :** Choose the channel that need to be set and the channel title will automatically display in the behind
- b) **Trigger schedule :** Set the trigger time periods.
- c) **Alarming Duration :** Set the alarm duration. After triggered alarm, system will output the alarm signal till you clean it by manual or the end of pre-setting alarm duration.
- d) **Alarm Associate :**
  - > Sound prompt: After triggered alarm, system will output “du...du...”warning tone.
  - > Buzzer : After triggered alarm , the buzzer on the machine will output “Di ...Di... Di” warning tone.
  - > Relay : After triggered alarm ,system will close the switch of relay to connect the outer alarm system.○
- e) **Video lost alarm :** Unlock video lost alarm, when video signal lost, system will trigger alarm.
- f) **Motion Detect :**

- > Sensibility :Set the video motion detect sensibility ,1 ~ 10levels optional ,level 10 is highest , level 1is lowest。 The higher-level set, the more sensitive when motion detected.
- > Prerecord : Set the prerecord time. After motion detect triggered alarm,
- > Recording duration : After motion detect triggered alarm, system will on-going record for the set duration time
- > Area setting : Set the motion detect area. Press setup button to enter the setup interface, as below: :

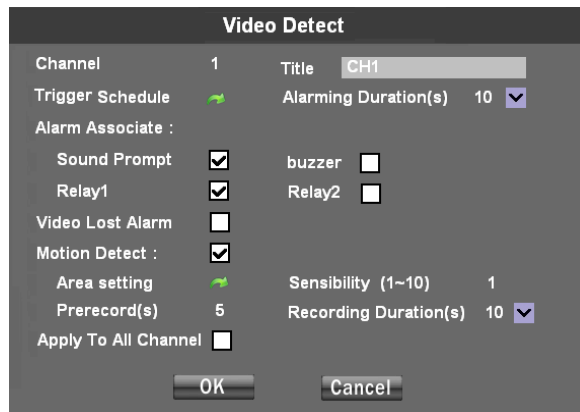
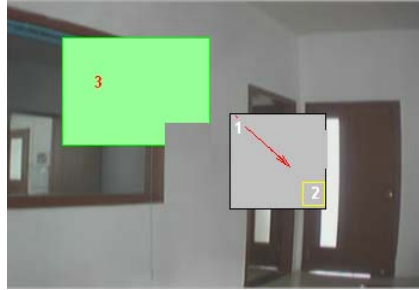

Pic.26 Video detect area setting

**Area setting** : press direction button to move the cursor to the detected area starting point, and press “Enter” button to confirm it, refer to the “1” position on above picture.

After the confirmation of starting point, press direction button to set the detecting area, refer to the “2” position on above picture. Press “Enter” button to finish the setting, the selected area will become to green color, refer to the “3” position on above picture. Use same method to set other detecting area.

**Area Edit** : Moving the selection box to the appropriate location in the selected area, use above-mentioned area selection way to edit the detection area.

**Apply to all channels**: Apply this video detection parameter setting to all channels

● **Sensor** :

**Set sensor trigger time, associate alarm and associate recording channel etc. Setting interface as below**

- a) Sensor channel No. : select sensor input channel number ( 1 ~ 16 )
- b) Trigger on : Unlock sensor trigger
- c) Trigger schedule : Set the trigger time periods
- d) Associate Channel : Set alarm trigger associate recording channel
  - > Prerecord time : Set the prerecord time. After sensor triggered alarm, system will ahead of “prerecord time” to start the recording
  - > Recording duration : After sensor triggered alarm, systems will on-going record for the set duration time.
- e) **Alarm associate**
  - > Sound prompt : After triggered alarm, system will output “du...du ...”warning tone.
  - > Buzzer : After triggered alarm ,the buzzer on the machine will output “Di ...Di... Di” warning tone.
  - > Relay : After triggered alarm , system will close the switch of relay to connect the outer alarm system.
  - > Alarming Duration : Set the alarm duration. After triggered alarm, system will output the alarm

signal till you clean it by manual or the end of pre-setting alarm duration.

- f) **Apply to all channel:** Apply this channel sensor parameter settings to all channels.

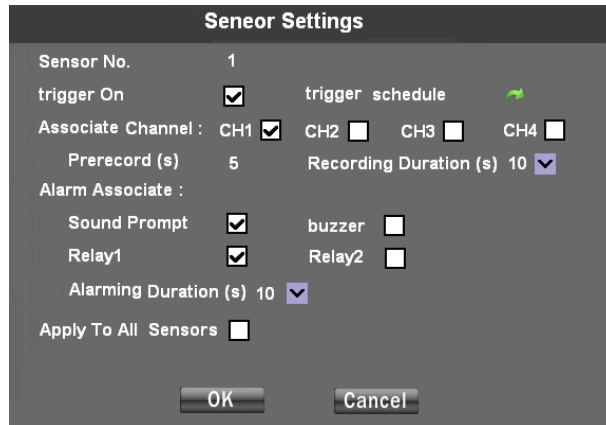

Pic.27 Sensor Setting

### 3.6.5 File Management

Manage the recording files , can search, playback and backup the recording files based on the given search condition. Search conditions include channel No., Date type, Record type, Recording date and search periods. Interface as below: Left is date column, the blue background of the date on behalf of the day that has recording files.

**1) Recording Search :**

Input Search channel No., Recording date and search time period. Press“Search” , It will show the time period which has the recording file in “Start time”、“End time” under the each chosen channels.

**2) Playback :** As above, input the search condition , press“Search”to play the eligible

**3) video files.** System support 8ch playback at the same time ( Means you can choose any 8CH at the most ) .

**4) Backup :**As above, input the search condition ,press“Backup”to copy the eligible video files to pointed device. Backup device selection interface as Pic.29 :

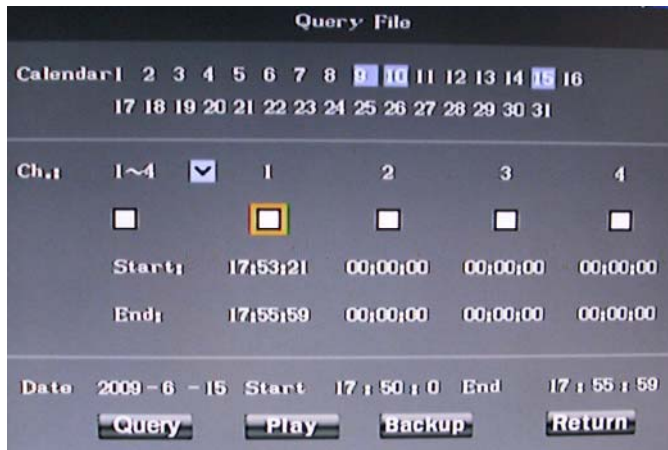

Pic.28 Recording Files Management

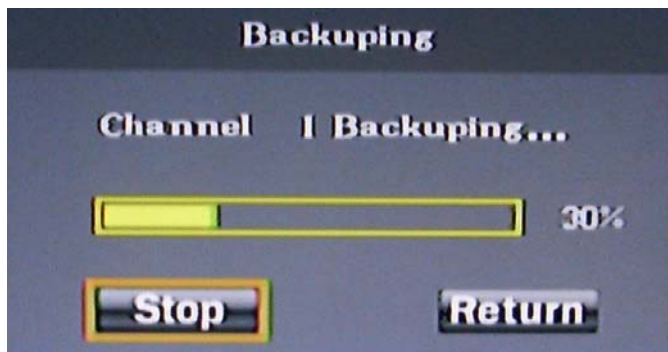

Pic.29 Video file backup

In operation interface, you can choose “play” or “Backup” this file to pointed device.

### 3.6.6 User Management

Create the user account, modify the user’s access, change password etc. Setting interface as

below :

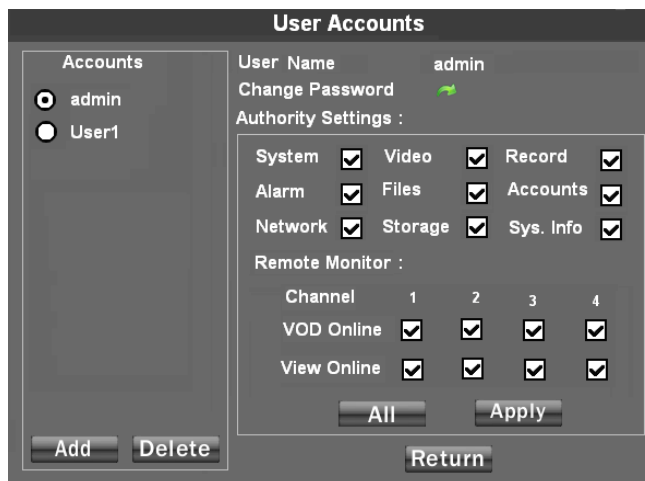

Pic.30 User management

**1) Add/Delete user account :**

System can manage 8 local accounts. Admin is default administrator account which can not be deleted.

Press “Add” button to pop-up user account create dialog box. As Below :

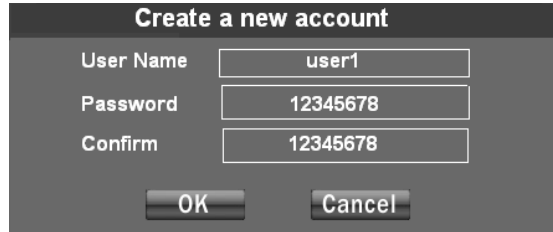

Pic.31 Create a new account

Input user name and password, press “ok” to finish the creation.

**NOTE : The maximum length of User name and password is 16 characters !**

**2) Change password :**

Press change password “” to popup the changing password dialog box, as below:



Pic.32 : Change password

**3) Authority settings :** Change user’s privilege and press “MODIFY” to confirm it.

**3.6.7 NET SET**

System support LAN、 DDNS and PPPOE. Setting interface as below :

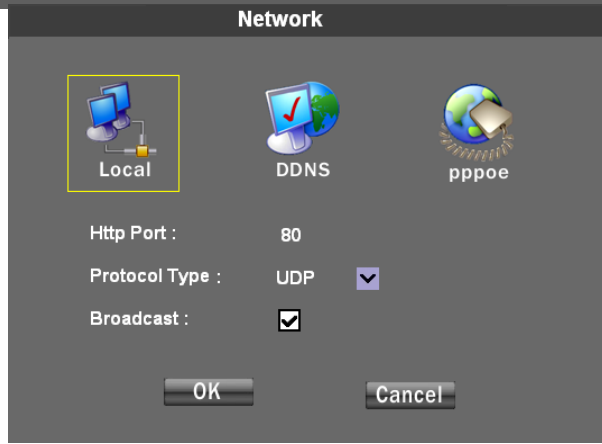

Pic.33 Network Setting

- 1) **HTTP port set** : Set HTTP port, default is 80.If this port changed, when login the host via Web server ( IE ),The IP address input method is IP add “ : ”and new port number. For example:( 192.168.1.121 :88 ):



图 34 Web Server Login

- 2) **Protocol Type** : Net transport protocol can be “UDP” or “TCP”. Usually choose “UDP” in LAN and choose “USE Multicast”; Choose “TCP” in WAN.

**NOTE: In WAN, please close “USE Multicast” !**

- 3) **Local Connect setting** : Local Connect setting also can set host IP, gateway and other clauses. You can choose “Obtain an IP automatically” or manual input IP. Setting interface as below:

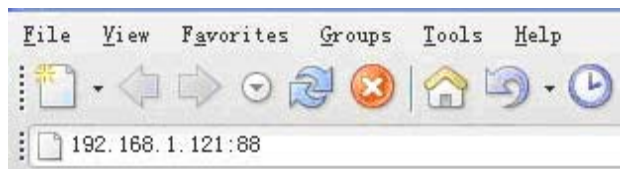
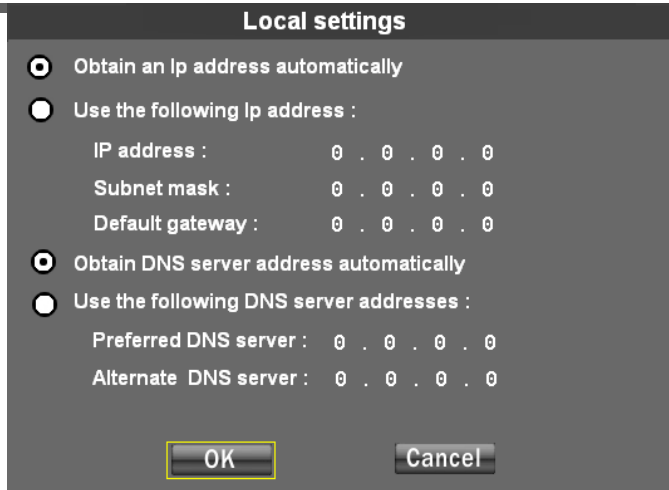

Pic.35 Local Setting

**a) Obtain an IP automatically :**

When connected network support DHCP IP(DHCP server open),when you choose “Obtain an IP automatically” , DHCP server will allocate an available IP. System default setting is “Obtain an IP automatically”.

**b) Manual input IP :**

System input manual input IP. When choose “Use the following IP address” , IP address filed will be editable, and you can input an IP address ,and then press “OK” to confirm it. DNS server can set in same way.

**DDNS setting :**

System support DDNS setting. You need to apply an account from the DDNS server provider( Such as Peanut passport : include account number, password and domain name , known as web site , for example:videoweb.vicp.net ) , and then input the account information into “DDNS setting” column , press “OK”, the system will connect the DDNS server automatically to apply DNS. The server will analyze corresponding domain name to host actual IP address. When the user wants to login the DVR, he only need to input the domain name in IE. Setting interface as below:

**Note :** We only test the [www.Oray.Net](http://www.Oray.Net) DNS server.

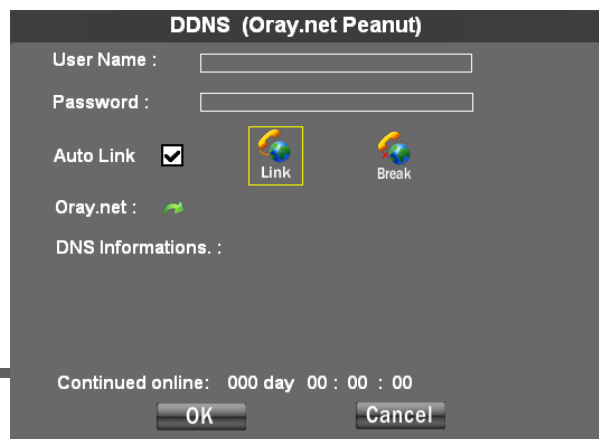



Pic.36 DDNS Setting

- 4) **PPPOE setting** : System support ADSL PPPOE dial connection directly. Connect the host with the ADSL model via RJ45 or LAN , it will dial automatically or by manual to connect the WAN .PPPOE setting interface as below:

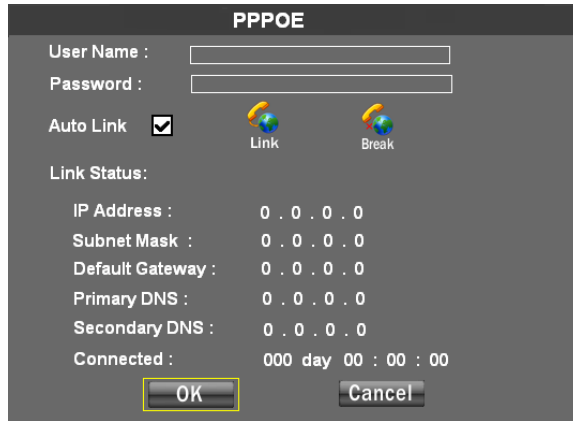

Pic.37 PPPOE Setting

### 3.6.8 Storage Management

Manage the storage device, display the device working condition, format and file selection.

Interface as below :

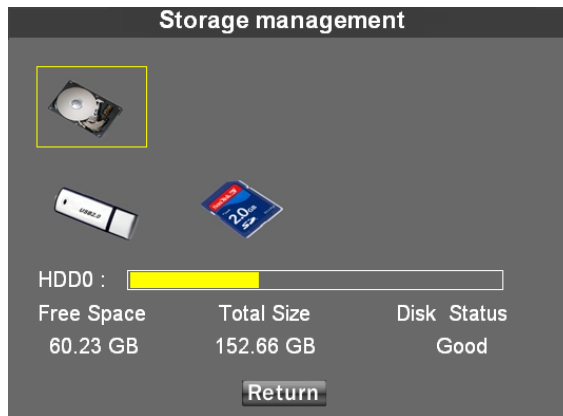

Pic.38 : Storage Management

- 1) **Device Info** : Select and display the device information, as above:

- 2) Device Format : Select the device, press “Delete” button to format this device in FAT32 division format.
- 3) File management : Press the device to enter “Stored File Info” list. In this list, you can choose the recording file to play or choose upgrade file to update the system.

### 3.6.9 System Info

Enter system info dialog box to check the host “Serial Number”, “Software Version”, “IP Address” and “MAC Address” etc

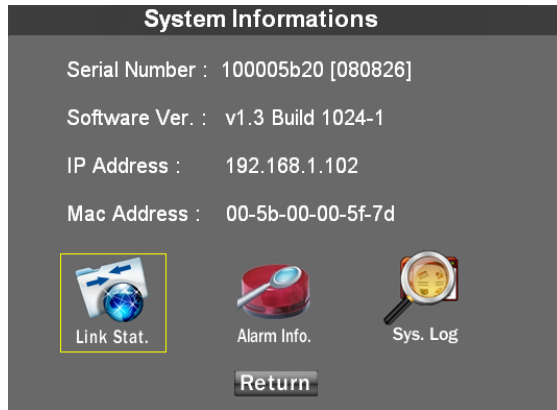

Pic.39 : System Information

1) **Host Information :**

Display the host serial No., software version, IP address and MAC address.

2) **Link statistics :**

Press “Link Stat.” to check the customer login information, and you can you can disconnect this IP connection. As below :

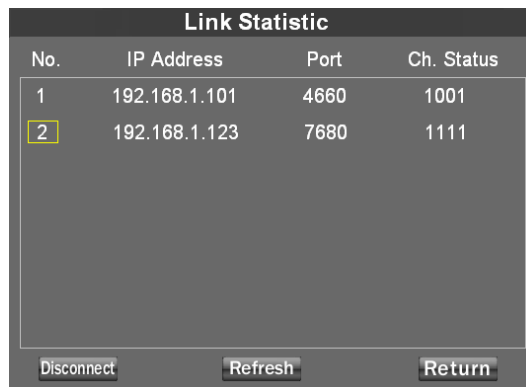

Pic.40 : Link Statistic

Above picture tell us the host is connected by two users. It also tells us the visitors IP, port No. and remote monitoring status. Channel status is displayed in 4 figures: “0” means close and “1” means open. The sequence is CH1-CH2-CH3-CH4.For example: 0101 means CH2 and CH4 are open and CH1 and CH3 are close. Select the connection IP and press “Disconnect” to cut off this connection.

**3) Alarm information :**

Check the system alarm status which is displayed into matrix form chart; junction shows the incident triggered alarm types. Green color means no alarm and red color means alarm triggered. When alarm triggered, you can press the triggered incidents to clean the alarm. As below



Pic.41 : Alarm information

**4) System log :**

Check the host operations recording. Input the date and press “SERACH” to list the operation recording.



Pic.42 : System Log

Left is date column, the blue background of the date on behalf of the day that has operation

## Chapter4 WAN connection

There are two methods to connect the DVR with WAN: one is PPPoE and the other is router forwarding.

### 4.1 PPPOE

Please check relevant chapter.

### 4.2 Router forwarding

#### 1 ) Set the host IP

Set the host IP in“Local setting” , please refer to the chapter “Net set”.

**Note : Set the “protocol” in “TCP” when connecting the DVR with WAN.**

#### 2 ) Port forwarding

Login the router and mapping following port:

80 : WEB port

9101 : order transport port

9301 : Support Video-on-demand

9501 : Support multi channels live picture transport

9601 : Support remote talkback

9801 : Support multi hosts connection backup

#### 3 ) DDNS (Oray.net)

Take oray software for example: first login the website [www.oray.net](http://www.oray.net) to apply user account and domain name.

There are tow method to login DVR via Oray domain name: One is setting the DDNS in host , the other is setting the DDNS in router.

#### **4 ) Remote login**

Input the Domain name in IE browser, for example: <http://dvrtest01.eicp.net:80> to open the surveillance window. You also can input the domain name in software to remote login the host.

#### **5 ) IE trusted site and security level setting**

a) Open Internet Explorer and press“tool” - >“Internet options”to bob up the following dialog box :

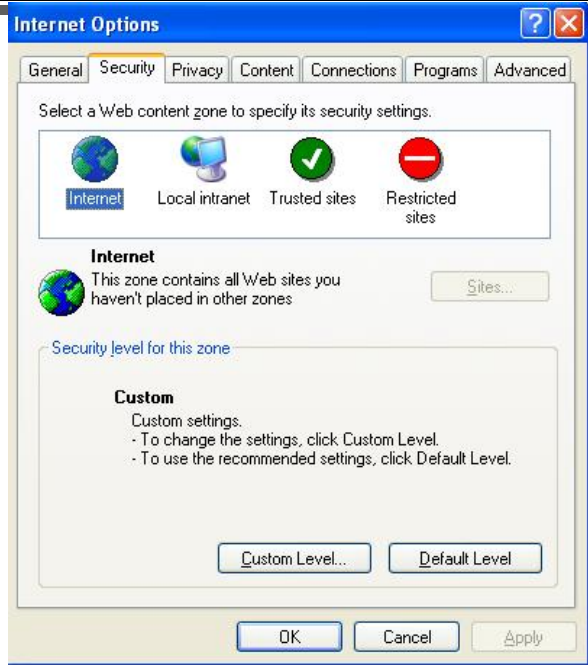

b) Press “Trusted sites” and “sites” in red box as follow to bob up the “trusted sites” dialog box:

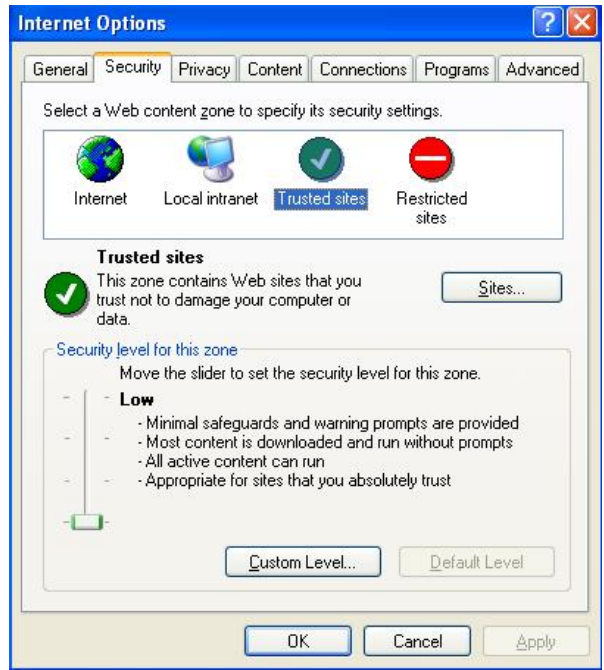

c) Input the DVR IP, press “add” and “OK” to quit this dialog box.

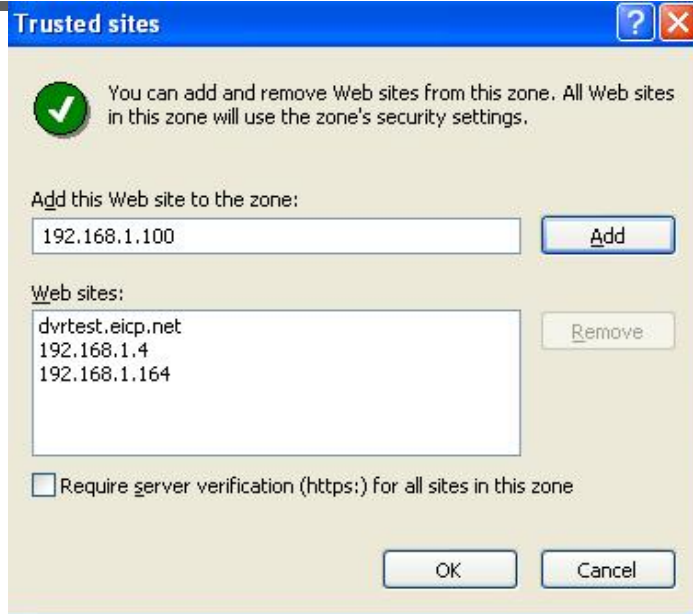

- d) After above setting, press “default level” to set the “security level” into “low” and then press “Apply”.

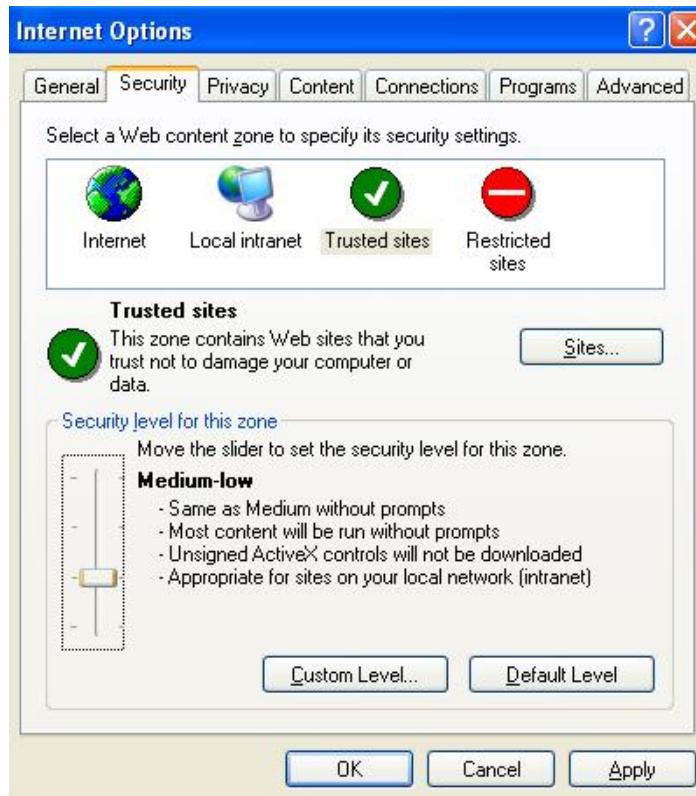



- e) Or you can set the custom level: press “custom level”and enable all clauses under the “ActiveX controls and plug-in” options.

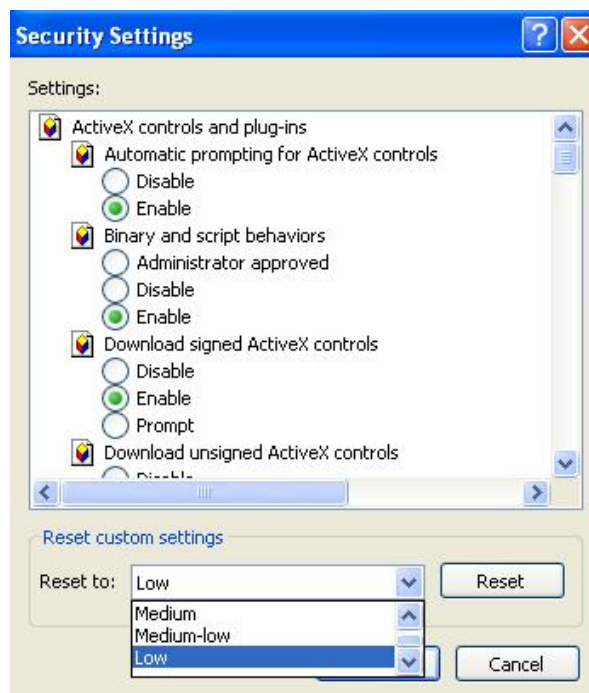

- f) In IE “Privacy” label, please cancel the “√” before the “Pop-up block”and then press“Apply”.



