



ULTRA SLIM
AUDIO SYSTEM
CD-R/RW PLAYBACK
EV-1/EV-1S

Instruction Manual



Safety Warnings

**CLASS 1 LASER PRODUCT
KLASSE 1 LASER PRODUKT
LUOKAN 1 LASER LAITE
KLASS 1 LASER APPARAT
PRODUCTO LASER CLASE 1**

CLASS 1 LASER PRODUCT

This Compact Disc player is classified as a CLASS 1 LASER product.

Use of controls adjustments or performance of procedures other than those specified herein may result in hazardous radiation exposure.

CAUTION-INVISIBLE LASER RADIATION WHEN OPEN AND INTER LOCKS DEFEATED, AVOID EXPOSURE TO BEAM.

WARNING: TO REDUCE THE RISK OF FIRE OR ELECTRIC SHOCK, DO NOT EXPOSE THIS APPLIANCE TO RAIN OR MOISTURE.

CAUTION: TO PREVENT ELECTRIC SHOCK, MATCH WIDE BLADE OF PLUG TO WIDE SLOT, FULLY INSERT.



CAUTION:

TO REDUCE THE RISK OF ELECTRIC SHOCK, DO NOT REMOVE REAR COVER, NO USER SERVICEABLE PARTS INSIDE, REFER SERVICING TO QUALIFIED SERVICE PERSONNEL.



This symbol indicates that dangerous voltage constituting of a risk of electric shock is present within this unit.



This symbol indicates that there are important operating and maintenance instructions in the owners manual accompanying this unit.

Wiring the Mains Power Supply Plug(UK Only)

IMPORTANT NOTICE

The mains lead on this equipment is supplied with a moulded plug incorporating a fuse. The value of the fuse is indicated on the pin face of the plug and, if it requires replacing, a fuse approved to BS1362 of the same rating must be used.

Never use the plug with the fuse cover omitted. If the cover is detachable. If a replacement fuse cover is required, it must be of the same colour as the pin face of the plug. Replacement covers are available from your dealer.

If the fitted plug is not suitable for the power points in your house or the cable is not long enough to reach a power point, you should obtain a suitable safety approved extension lead or consult your dealer for assistance.

However, if there is no alternative to cutting off the plug, remove the fuse and then safely dispose of the plug. Do NOT connect the plug to a mains socket as there is a risk of shock hazard from the bared flexible cord.

IMPORTANT

The wires in the mains lead are coloured in accordance with the following code:-

BLUE = NEUTRAL BROWN = LIVE

As these colours may not correspond to the coloured markings identifying the terminals in your plug, proceed as follows:-

The wire coloured BLUE must be connected to the terminal marked with the letter N or coloured BLUE or BLACK. The wire coloured BROWN must be connected to the terminal marked with the letter L or coloured BROWN or RED.

WARNING: DO NOT CONNECT EITHER WIRE TO THE EARTH TERMINAL WHICH IS MARKED WITH THE LETTER E OR BY THE EARTH SYMBOL  , OR COLOURED GREEN OR GREEN AND YELLOW.

Precautions

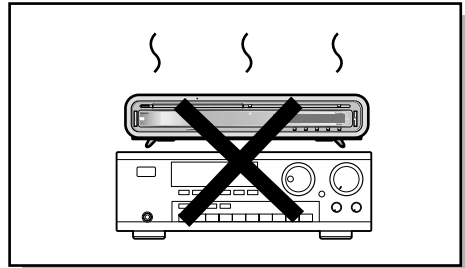
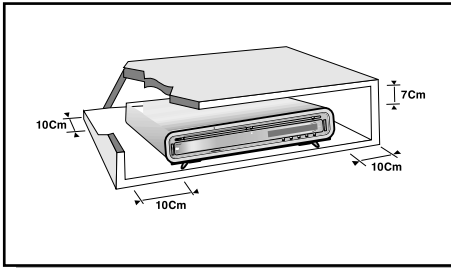

Ensure that the AC power supply in your house complies with the identification sticker located on the back of your player. Install your player horizontally, on a suitable base (furniture), with enough space around it for ventilation (3-4inches). Make sure the ventilation slots are not covered. Do not stack anything on top of the player. Do not place the player on amplifiers or other equipment which may become hot. Before moving the player, ensure the disc tray is empty. This player is designed for continuous use. Switching off the CD player to the stand-by mode does not disconnect the electrical supply. In order to disconnect the player completely from the power supply, remove the main plug from the wall outlet, especially when left unused for a long period of time.

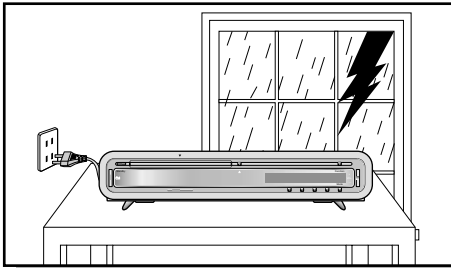

During thunderstorms, disconnect the main plug from the socket. Main voltage peaks due to lightning could damage the unit.

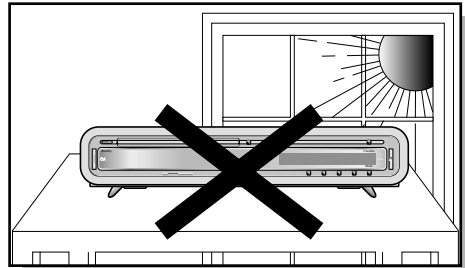

Do not expose the unit to direct sun radiation or other heat sources. This could lead to overheating and malfunction of the unit.

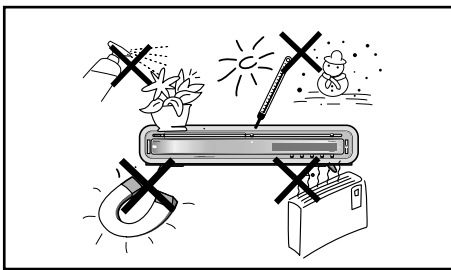

Protect the player from moisture (dripping or splashing and that no objects filled with liquids, such as vases, shall be placed on the player), and excess heat (e.g. fireplace) or equipment creating strong magnetic or electric fields (i.e. speakers...) disconnect the power cable from the mains electricity supply if the player malfunctions. Your player is not intended for industrial use but for domestic purposes only. Use of this product is for personal use only. Condensation If your player or disc have been stored in a cold atmosphere, as for example during transportation in the winter, wait for approximately 2 hours until they have reached room temperature.

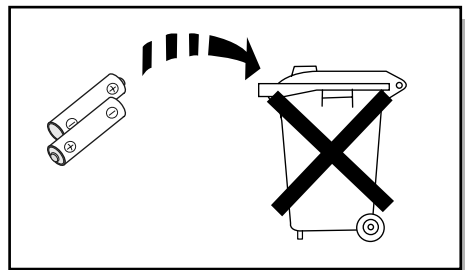

The battery used in this product contains the chemicals that are harmful to the environment. Do not dispose of batteries in the general household waste. It is recommended that the replacement of the battery should be done by technician.

Thank you for buying this
SAMSUNG ULTRA SLIM audio system.

Please take time to read these instructions.
They will allow you to operate your
system with ease and take full advantage
of its features.

◆ SAFETY WARNINGS	1
◆ Precautions	2
◆ INSTALLING YOUR ULTRA SLIM AUDIO SYSTEM	
■ Front Panel View	4
■ Rear Panel View	4
■ Remote Control	5
■ Speaker Connection	6
■ Connecting your System to the Power Supply	6
■ Connecting the FM and AM(MW/LW) Antennas	7
■ Connecting to an External Source	8
■ Viewing the Various Functions on Your System	8
■ Adjusting the brightness of the LCD display	8
■ Using the function button	9
■ Using the Mode button	9
■ Setting the Clock	10
■ Listening to a Compact Disc	10
■ Regarding the playback of CD-R/RW	10
■ Selecting a Track	11
■ Searching for a Specific Music Passage on a CD	11
■ Function to skip through 10 tracks at a time	11
◆ CD-PLAYER	
■ Random play function	12
■ Repeating One or All Tracks on the Compact Discs	12
■ Programming the Order of Playback	13
■ Checking or Changing Programmed Tracks	13
■ Searching for and Storing the Radio Stations	14
■ Selecting a Stored Station	14
■ Improving Radio Reception	14
◆ TUNER	
■ About RDS broadcasting	15
■ About RDS DISPLAY function	15
■ PTY(Program Type) indication and PTY-SEARCH function	16
■ Timer Function	17
■ Cancelling the Timer	17
■ Mute Function	18
■ Selecting an Equalizer Preset	18
■ S. Bass Function	18
■ Power Sound	18
◆ OTHER FUNCTIONS	
■ Setting the System to Switch off Automatically	19
■ Connecting Headphones	19
◆ RECOMMENDATIONS FOR USE	
■ Cleaning Your ULTRA SLIM Audio System	19
■ Precautions When Using Compact Discs	19
■ Before Contacting the After-Sales Service	20
■ Technical Specifications	21

Symbols



Front Panel View

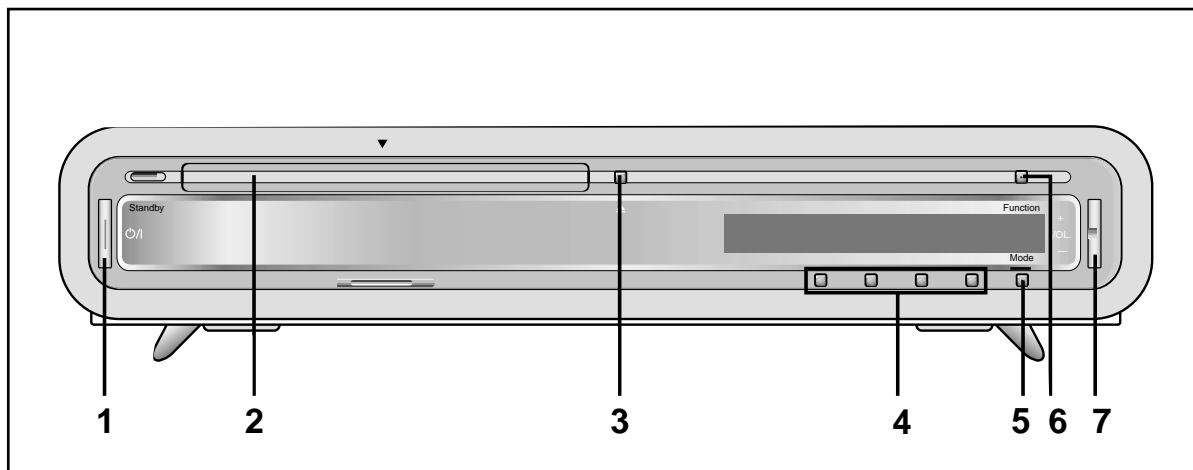

1. On/Standby
2. Disc Tray
3. Open/Close
4. Multi-function Button
*Depending on the selected Mode, pressing the corresponding button will activate that button.
5. Mode
6. Function(CD, TUNER, AUX)
7. Volume

Rear Panel View

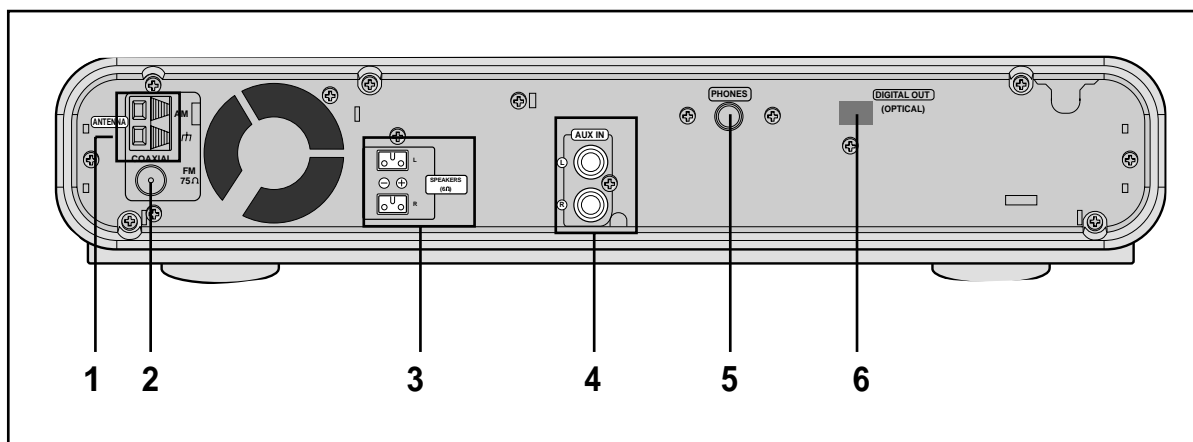

1. AM Aerial Connector Terminal
2. FM Aerial Connector Terminal
3. Speaker Connector Terminal
4. Aux-Input
5. Headphone Jack connector
6. Digital Out Jack

Remote Control

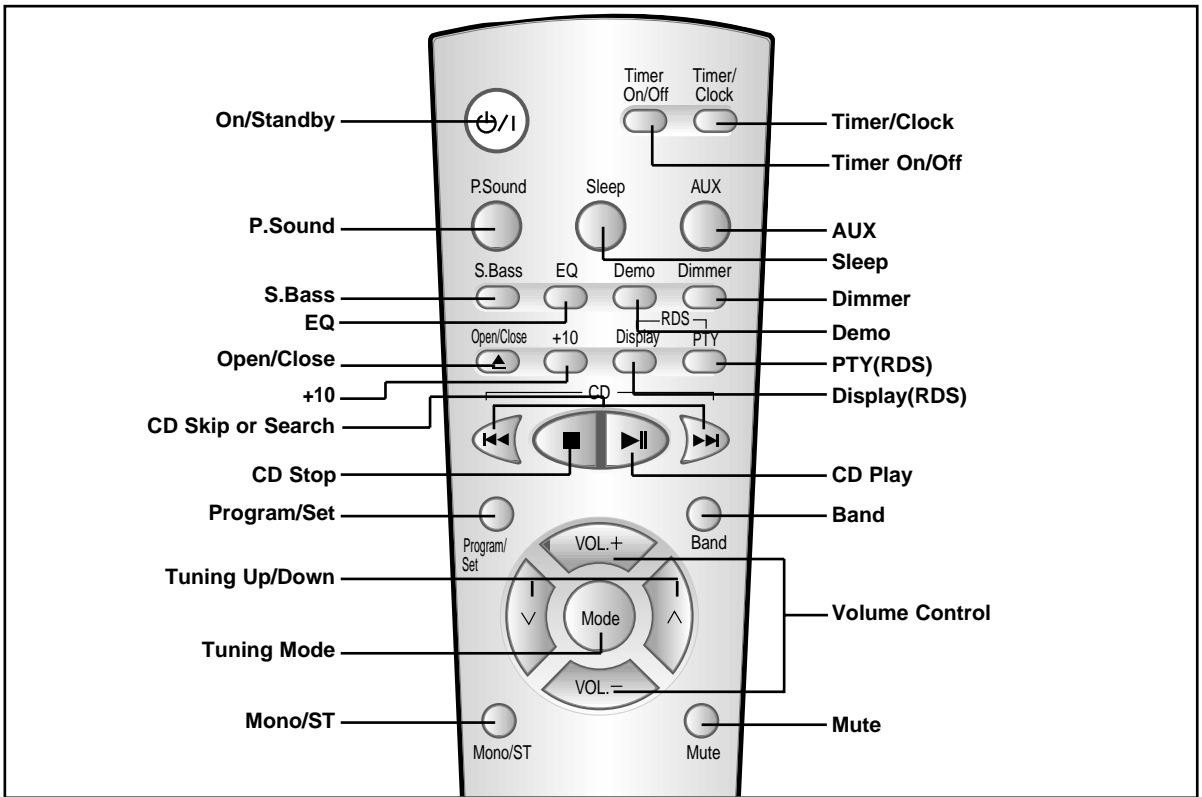

Insert Remote Batteries

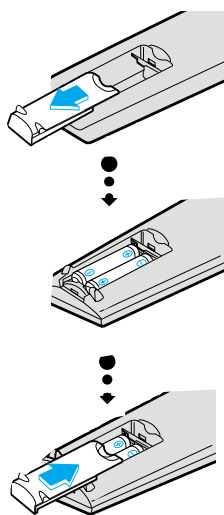

- 1** Remove the battery cover on the back of the remote by pressing down and sliding the cover in the direction of the arrow.
- 2** Insert two 1.5V AAA batteries, paying attention to the correct polarities (+ and -).
- 3** Replace the battery cover.

CAUTION Follow these precautions to avoid leaking or cracking cells:

- Place batteries in the remote control so they match the polarity:(+) to (+)and (-)to (-).
- Use the correct type of batteries.Batteries that look similar may differ in voltage.
- Always replace both batteries at the same time.
- Do not expose batteries to heat or flame.

Range of Operation of the Remote Control

The remote control can be used up to approximately 23 feet/7 meters in a straight line. It can also be operated at a horizontal angle of up to 30° from the remote control sensor.

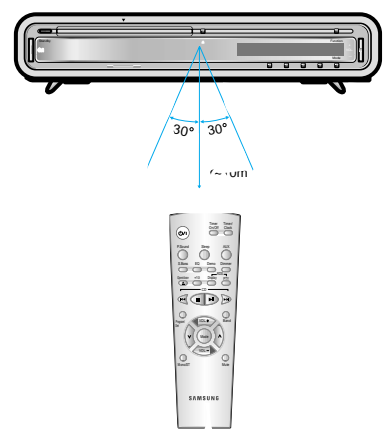

Speaker Connection



- **Speaker Connection:** Connect the Speaker cords (red/black) to the Speaker jack of the system.

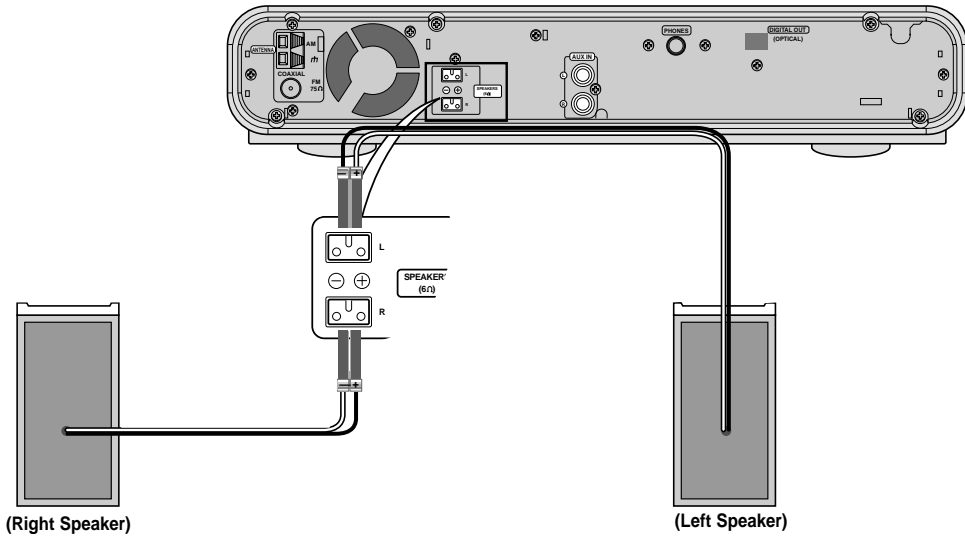

Directions in Installing Speaker

- Installation in a place near heating apparatus, under directly of light or with high humidity may cause performance deration of the speaker.
- Do not install on the wall or on a high place of pole or other unstable place to prevent any safety accident caused by falling of the speaker.
- Do not take the speaker apart from TV or computer monitor.
The speaker near the TV or computer monitor may influence the quality of the screen display.

Connecting your System to the Power Supply

The main lead must be plugged into an appropriate socket.

- Before plugging your system into a main socket, you must check the voltage.

1. Plug the main lead (marked AC Cord on the rear of the system) into an appropriate socket.
2. Press the On/Standby button to switch your ULTRA SLIM audio system on.

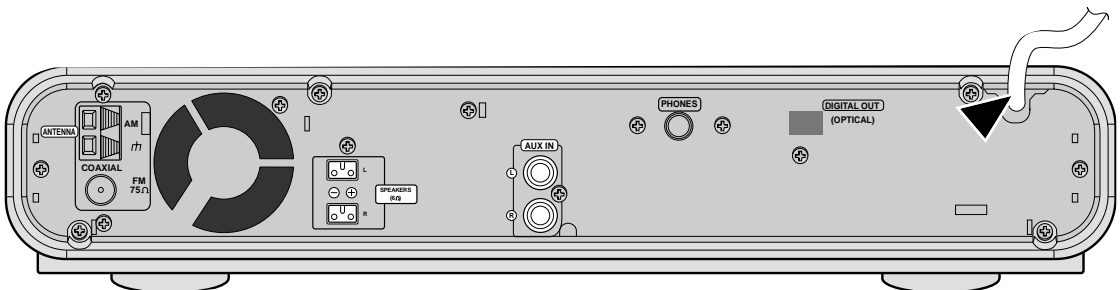

Connecting the FM and AM(MW/LW) Antennas

GB

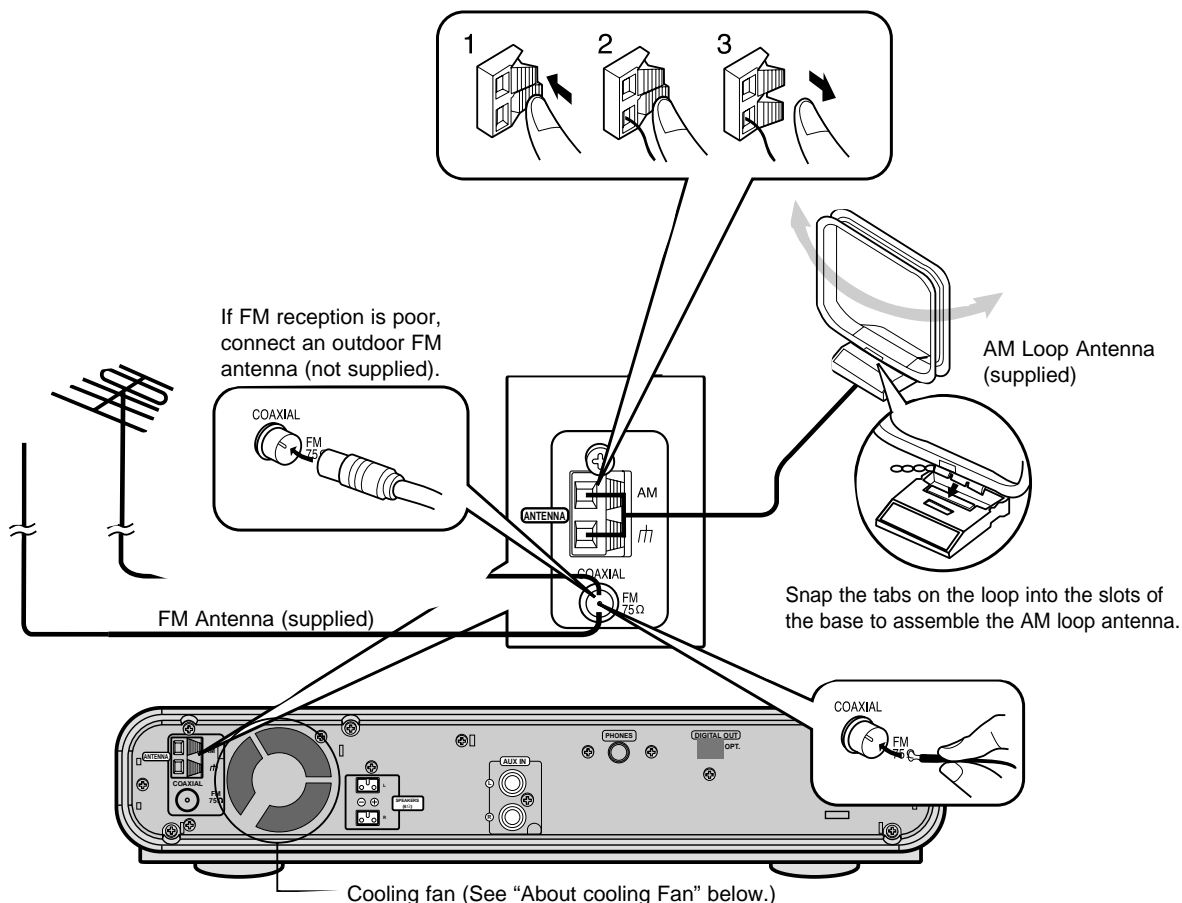

FM antenna connection

1. Connect the FM antenna supplied to the FM 75Ω COAXIAL terminal.
2. Slowly move the antenna wire around until you find a location where reception is good, then fasten it to a wall or other rigid surface.

- If reception is poor, connect an outdoor antenna. Before attaching a 75Ω coaxial cable (with a standard type connector), disconnect the supplied FM antenna.

AM(MW/LW) antenna connection

1. Connect the AM loop antenna supplied to the AM and Π terminals.
2. If reception is poor, connect an outdoor single vinyl-covered wire to the AM terminal. (Keep the AM loop antenna connected).

(About the cooling fan)

A cooling fan is mounted on the rear panel of the center unit to prevent abnormal temperature inside the center unit, thus assuring normal operation. The cooling fan automatically starts rotating to supply external cool air to the inside of the center unit when the internal temperature exceeds the specified limit.

For safety, observe the following carefully.

- Make sure there is good ventilation around the center unit. Poor ventilation could overheat and cause damage.
- DO NOT block the cooling fan and the ventilation openings or holes. (If they are blocked by a newspaper or cloth, etc., the heat may not be able to escape.)

Connecting to an External Source

The auxiliary input can be used to take advantage of the sound quality of your ULTRA SLIM audio system when listening to other sources.

- Examples:**
- ◆ A television
 - ◆ A video disc player
 - ◆ A Hi-Fi stereo video cassette recorder

➤ To connect the external source, the source must have an audio output. In addition, you need an RCA connection cable.

1 Set the system to standby mode and disconnect it and the external source from the main.

2 Connect the audio cable to the rear of the ULTRA SLIM audio system.

Connect the... To the connector marked...

Red jack R (right)

White jack L (left)

➤ For optimum sound quality, do not invert the right and left channels.

3 Plug the system back into the main socket and press **On/Standby** (⏻) to switch it on.

4 Select the AUX source by pressing the **AUX** button.
Result: **AUX** is displayed.

5 Switch the external source on.

6 Adjust the volume and balance as required:

- ◆ Volume
- ◆ Equalizer
- ◆ S.Bass

Example: You can watch a film and take advantage of stereo sound provided that the original sound track is in stereo (as if you were in a cinema).

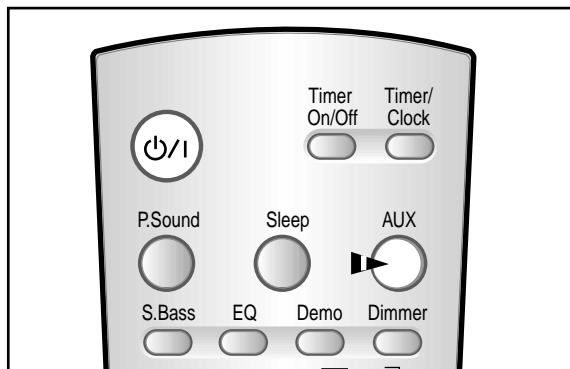
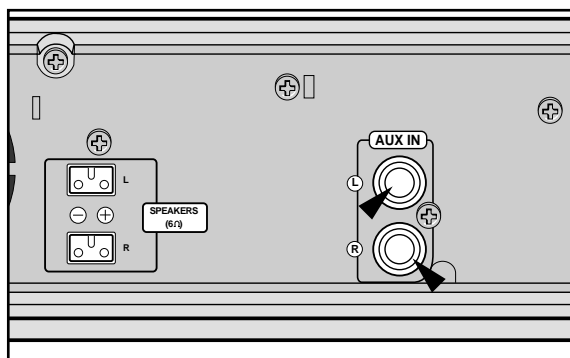

Viewing the Various Functions on Your System

You can view the various functions available on your system.

1 Press the **Demo** button.
Result: The various functions available are listed in turn on the display.

➤ All these functions are described in detail in this booklet. For instructions on how to use them, refer to the appropriate sections.

2 To cancel this function, press **Demo** again.

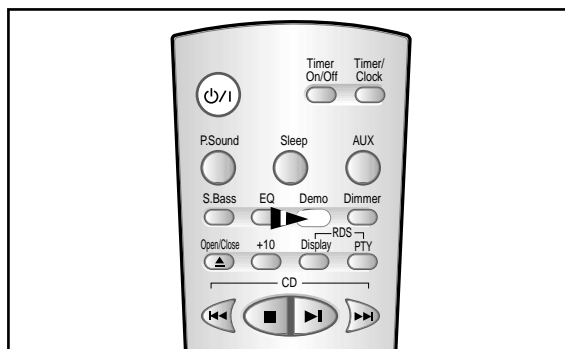

Adjusting the brightness of the LCD display

You can adjust the brightness of the LCD display depending on the surrounding lighting conditions

Press the **Dimmer** button on the remote control to adjust the brightness.

- ◆ The selection switches each time the button is pressed:
Dimmer1(Bright) → Dimmer2 (Medium) → Dimmer3(Dim).

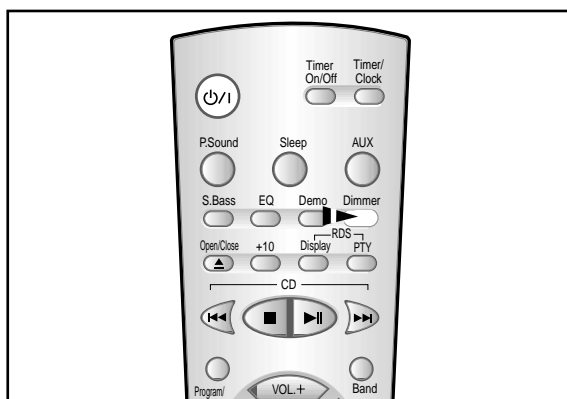

Using the Function button

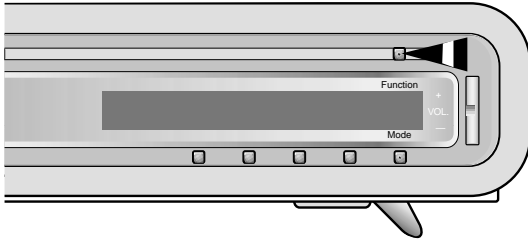

- Press the Function button
Each time the button is pressed, one of the following function are selected.

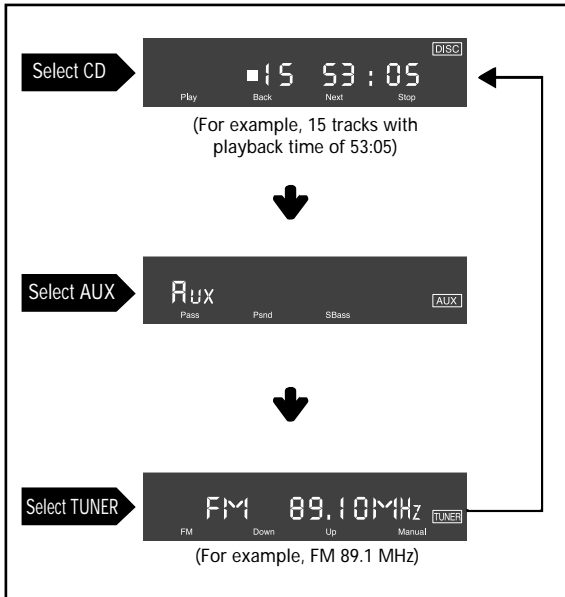

About the Mode button

If no button is pressed within 8 seconds while in the Mode 1 or Mode 2, the Display switches to the Normal Mode.

Using the Mode button

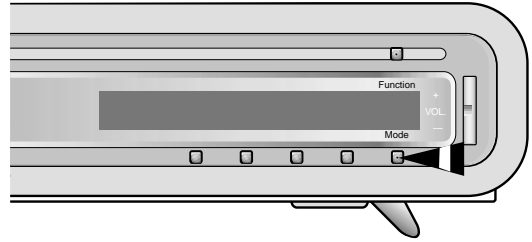

- Press the Mode button on the front panel of the main unit.
Each time the button is pressed, the selection changes as follows.
You can pressed the button below the display to select the desired function.

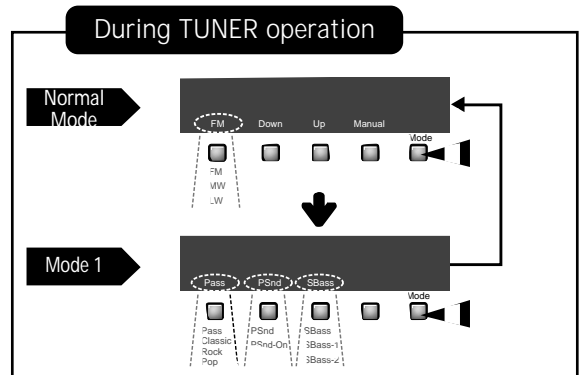
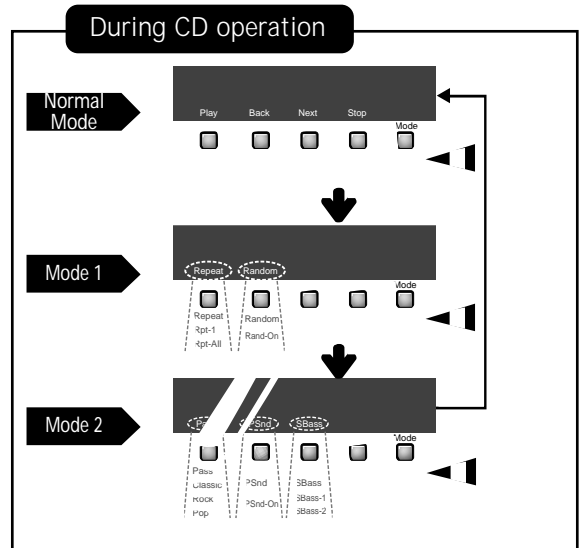

➤ Mode does not work in AUX Function.

Setting the Clock

Your system is equipped with a clock which allows you to turn your system on and off automatically.

You should set the clock:

- ◆ When you first purchase the ULTRA SLIM audio system
- ◆ After a power failure
- ◆ After unplugging the unit

◆ For each step, you have a few seconds to set the required options. If you exceed this time, you must start again.

1 Switch the system on by pressing **On/Standby** ().

2 Press **Timer/Clock** twice.
Result: **Clock** is displayed.

3 Press **Program/Set**.
Result: The hour flashes.

To...	Press...
Increase the hours	^
Decrease the hours	v

5 When the correct hour is displayed, press **Program/Set**.
Result: The minutes flash.

To...	Press...
Increase the minutes	^
Decrease the minutes	v

7 When the correct time is displayed, press **Program/Set**.
Result: The clock starts and is displayed, even when the system is in standby mode.

➤ You can display the time, even when you are using another function, by pressing **Timer/Clock** once.

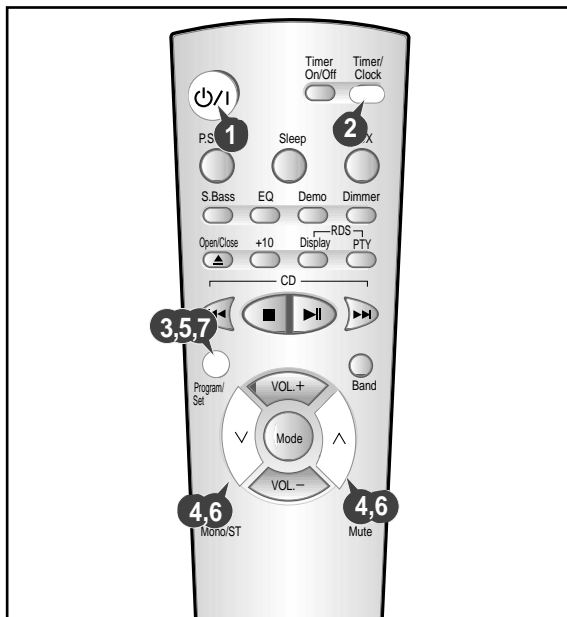

Listening to a Compact Disc

◆ Do not use CDs of irregular shapes like heart or octagon shapes. The performance of the player be degraded.

➤ The CD disc 12 cm or 8 cm compact discs without using an adapter.

1 Press the **CD** button on the main body and select CD.

2 Press the **Open/Close** () button.
Result: The CD tray is opened.

3 Place the CD on the tray so that the CD Label faces upward.

4 Press the **Open/Close** () button to close the tray.
Result: Number of tracks and the total playback time are shown on the display.

5 Press the **CD** () button for playback.

6 Adjust the volume according to needs with the following procedures.
◆ Press the **VOL.+** or **-** button on the remote control
◆ Press the **VOL.+** or **-** button on the front panel.

7 If it desired to stop while the playback is processing, press the **CD** () button.

➤ Press the **CD** () button once again to playback again.

8 To stop playback, press the () button.

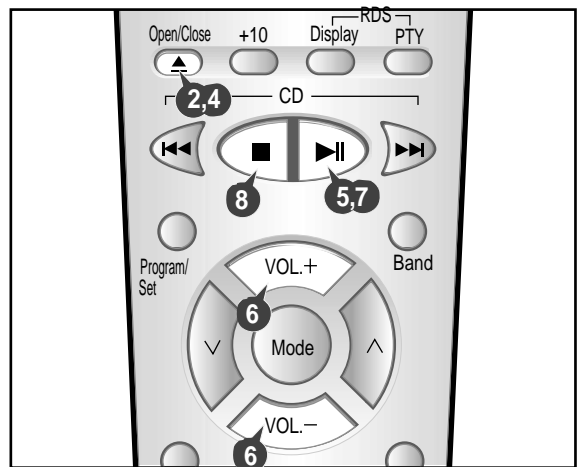

Regarding the playback of CD-R/RW

- ◆ In the case of an original CD-R(Recordable) recorded in audio CD format, CD-RW(Rewritable)and editing by the user, playback is processed on the respective completed status. (The player may not be played back according to the characteristics of the CD or recorded status.)
- ◆ The CD-RW is comparably less reflexive than CD which cause more time delay to read.

Selecting a Track



You can select the track you wish to listen to, either when the compact disc player is stopped or when a disc is playing.

To start playback at the beginning of the...	Press...
Next track	▶▶ once
Current track	◀◀ once
Previous track	◀◀ twice
Track of your choice	◀◀ or ▶▶ the appropriate number of times.

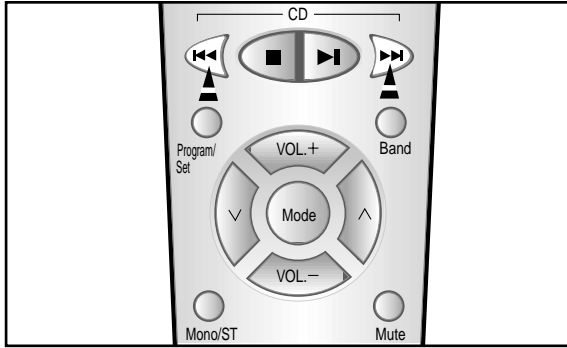

Searching for a Specific Music Passage on a CD

When listening to a compact disc, you can quickly search for a specific music passage on a track.

To search through the tracks...	Press and hold down...
Forwards	▶▶ for at least one second
Backwards	◀◀ for at least one second

➤ It is recommended that you turn the volume down before using this function.

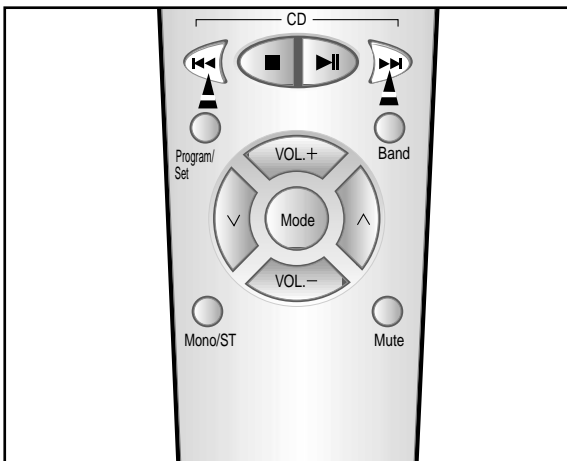

Function to skip through 10 tracks at a time

Press the +10 button briefly while playing back a CD. The track 10 tracks after the current one will then be played back.

Example: If you want to select track 43 during playback of track 15, press the +10 button three times, and then press the ▶▶ button three times.

15 → 20 → 30 → 40 → 41 → 42 → 43

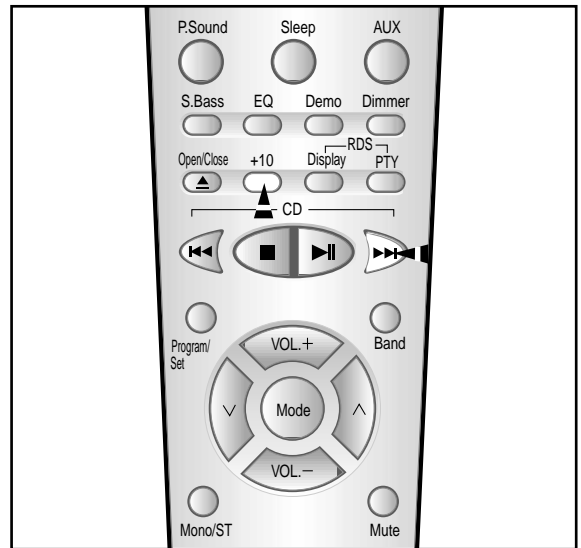

Random play function

You can listen to the tracks on a compact disc in a different order each time, as the various tracks will be selected automatically in a random sequence.

- 1 Press the Mode button on the Front Panel until **"Random"** is displayed to bottom.
 - ◆ If this button is pressed when the CD is being played back or stopped, any track recorded in the CD may be selected to playback again.
- 2 Press Random button, **"Rand-On"** is displayed.
- 3 When you finished the random playback, press the Random button again.

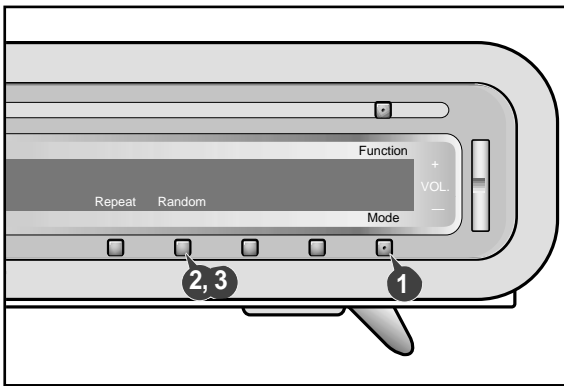

Repeating One or All Tracks on the Compact Discs

You can repeat indefinitely:

- ◆ A specific track on a compact disc.
- ◆ All tracks on the compact disc selected.

- 1 Press the **Mode** button on the front Panel until **"Repeat"** is displayed on the bottom.
- 2

To repeat...	Press the Repeat button one or more times until...
The current track indefinitely	Repeat 1 is displayed
All songs	Repeat All is displayed
- 3 When you wish to stop the Repeat function, press the **Repeat** button until **"Repeat off"** is displayed.

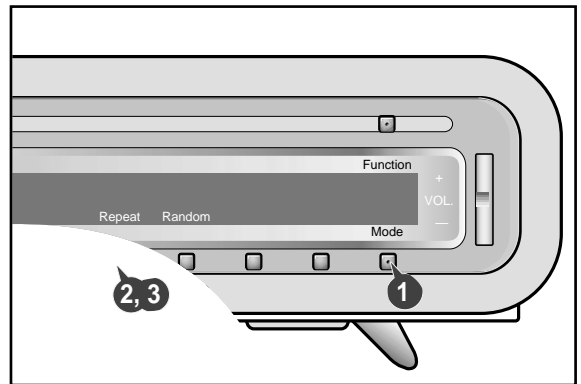

- If no button is pressed within 8 seconds, the Display changes to the Normal Mode. To proceed with the third operation, you should repeat from the first operation.

Programming the Order of Playback

You can decide:

- ◆ The order of the track desired to listen
- ◆ The track not desired to listen
 - ◆ A maximum of up to 24 order of tracks desired to listen may be programmed.
 - ◆ Before selecting the track, the CD player should be stopped.
 - ◆ This function may be used simultaneously with the CD Repeat function.

- 1 Load the selected CDs.
- 2 If the CD function is selected, stop the player by pressing ■ button .
- 3 Press **Program/Set**.
Result: The following indications are displayed:

Pr : 01 Tr : _____
Program no. Track no. on the disc

- 4 Select the required track by pressing:
 - ◆ ◀◀ to move back through the tracks
 - ◆ ▶▶ to move forward through the tracks
- 5 Press **Program/Set** to confirm your selection.
Result: The selection is stored and is displayed.
- 6 To select other tracks, repeat Steps 5 to 6.
- 7 Press **CD** (▶▶) to listen to the track selection in the order programmed.
- 8

To...	Press...
Listen to the current track again	◀◀ once
Listen to the previous track	◀◀ twice
Listen to the next track	▶▶ once
Skip forwards or backwards	◀◀ or ▶▶ the appropriate number of times
- 9 To cancel the selection, press ■ button.
 - ◆ Once if the compact disc player is stopped
Result: **Program function** is no longer displayed.

➤ ◆ If you open the compartment, the selection is cancelled.

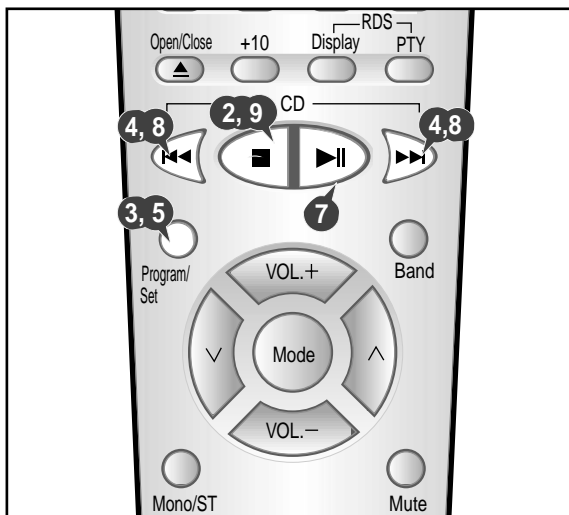

Checking or Changing Programmed Tracks

You can check or change your selection of tracks at any time.

- 1 Press ■ once if you have started listening to the selection.
- 2 Press **Program/Set** twice.
Result: The following indications are displayed:

Ch : 01 Tr : _____
Program no. Track no. on the disc

➤ If you have already programmed 24 tracks, **Ch** is displayed instead of **Pr** when you press **Program/Set**.

- 3 Press **Program/Set** one or more times until the track to be changed is displayed.
- 4 Press ◀◀ or ▶▶ to select a different track.
- 5 Press **Program/Set** to confirm your change.
- 6 Press **CD** (▶▶) to start listening to the selection.
Result: The first track selected is played.

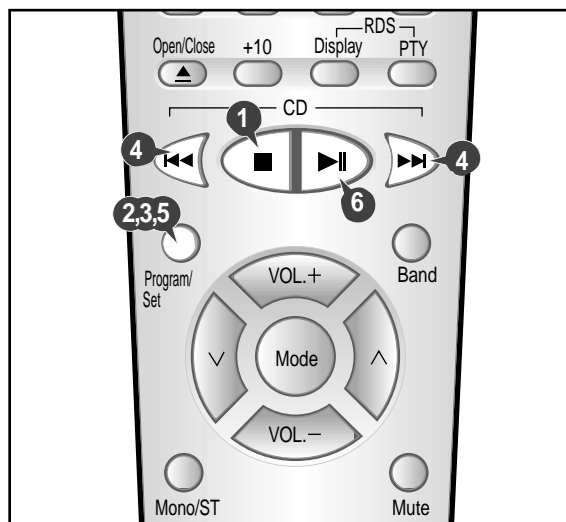

Searching for and Storing the Radio Stations

You can store up to:

- ◆ 15 FM stations
- ◆ 15 MW stations
- ◆ 7 LW stations

- 1 Switch the system on by pressing **On/Standby** ().
 - 2 Select the required frequency band by pressing **Band** on the remote control.
Result: The appropriate indication is displayed:

◆ FM	Frequency Modulation
◆ AM(MW)	Medium Wave
◆ LW	Long Wave
 - 3 To search for a station... Press Mode on the remote Control

Manually	One or more times until Manual is displayed.
Automatically	One or more times until Auto is displayed.

➤ PRESET function is explained in detail in the section "Selecting a Stored Station" on.
 - 4 Select the station to be stored by:
 - ◆ Pressing ∇ or \wedge buttons to increase or decrease the frequency respectively.
 - ◆ To scroll through the frequencies faster when searching manually, hold down the \lll or \ggg buttons.
 - ◆ The automatic search procedure may stop on a frequency that does not correspond to a radio station. If this happens, use the manual search mode.
 - 5 If you do not want to store the radio station found, revert to Step 4 and search for another station.
 Otherwise:
 - a Press **Program/Set**.
Result: 'Program No.' is displayed for a few seconds.
 - b Press **Program/Set** to store the radio station.
Result: 'Program No.' is no longer displayed and the station is stored.
 - 6 To store any other radio frequencies required, repeat Steps 3 to 5.
- ◆ The PROGRAM function can be used to assign a new station to an existing program number.

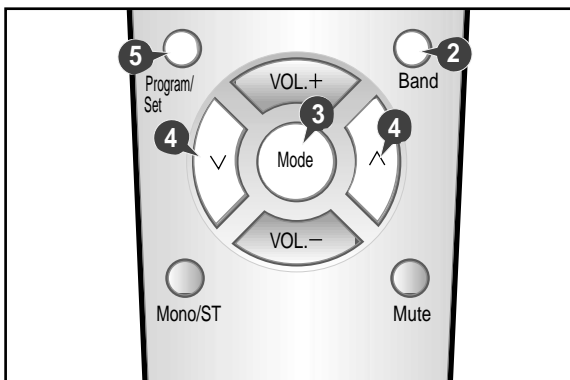

Selecting a Stored Station

You can listen to a stored radio station as follows:

- 1 Switch the system on by pressing **On/Standby** ().
- 2 Select the required frequency band by pressing **Band** on the remote control.
- 3 Select the radio station as follows.

To listen to ...	Press ...
Stored station	1. Press the Mode button on the remote control until " Preset " is displayed. 2. Press ∇ or \wedge button to select the required program.

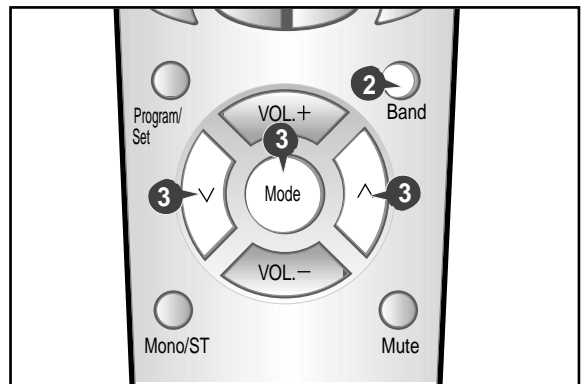

Improving Radio Reception

You can improve the quality of radio reception by:

- ◆ Rotating the FM or AM(MW) aerial
- If reception from a specific FM radio station is poor, press **Mono/ST**. to switch from stereo mode to mono. The quality of the sound will be improved.

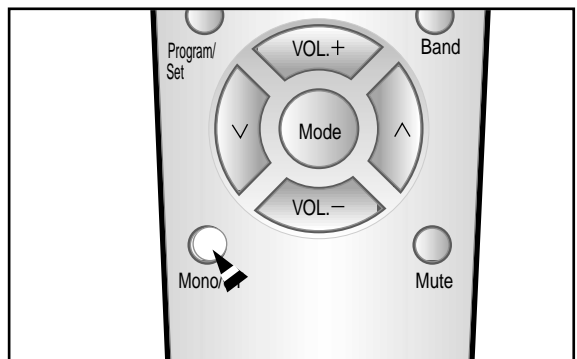

About RDS broadcasting

GB

This unit has the RDS (Radio Data System) function, which enables for the various information such as broadcasting station, radio text, time and 30 types of programs (News, Rock, Classic, etc.) to be received from the FM RDS station together with normal radio signal.

- 1 Press the **On/Standby** () button.
- 2 Receive the FM radio.
 - ◆ See the radio receiving method on the **page 14**.
 - ◆ FM and frequency are shown on the display
 - ◆ If the received station transfers the RDS information, 'RDS' appears automatically on the display.
- 3 Press the **RDS Display** button to select the desired RDS mode.
 - ◆ Whenever the button is pressed, RDS mode changes as follows.

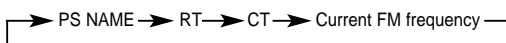

- ◆ The RDS function is available only in **FM** broadcasting.

➤ Description on RDS function

1. **PTY**(Program Type) : Displays the type of programme currently being broadcast
2. **PS NAME**(Program Service Name) : Indicates the name of broadcasting station and is composed of 8 characters.
3. **RT**(Radio Text) : Decodes the text broadcast by a station (if any) and is composed of maximum 64 characters.
4. **CT**(Clock Time) : Decodes the real time clock from the FM frequency.
 - Some stations may not transmit PTY, RT or CT information therefore this may not be displayed in all cases.
5. **TA**(Traffic Announcement) : When this symbol flashes it shows that the traffic announcement is in progress.

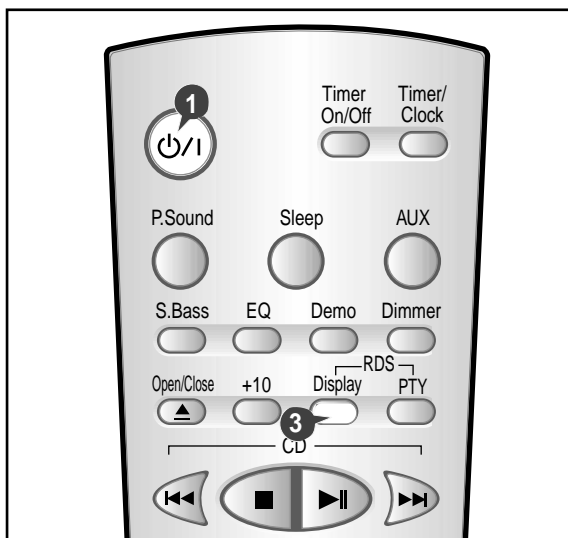

About RDS DISPLAY function

About "PS NAME" MODE

- Displays the name of broadcasting station.

Press the **RDS Display** button to select the PS NAME.

- ◆ "PS NAME" appears on the display.
- ◆ If the PS information is being received, the PS name (BBC, AFO, NDR, etc.) is shown on the display.
- ◆ If the PS information isn't received, the original FM frequency is shown.

- ◆ Even though no **RDS Display** button is pressed, the reception of PS information ensures the PS name is displayed.

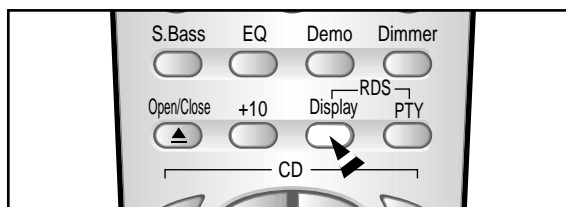

About 'RT' MODE

- Displays the character transmitted from the broadcasting station.

Press the **RDS Display** button to select the RT MODE.

- ◆ "RT" appears on the display.
- ◆ If the RT information is being received, the received information is shown on the display.
- ◆ If the RT information isn't received, the "NO RT" is shown. On the display.

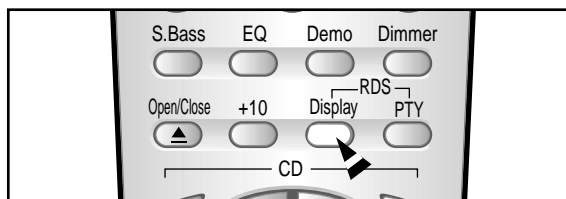

About CT(Clock Time)

- Sets the time of RDS clock.

To select the CT time, set the **RDS Display** button to CT MODE.

- ◆ The CT information will take up to 2 minutes to be decoded therefore the clock isn't displayed immediately.
- ◆ If there is no received CT information, "NO CT" is displayed.

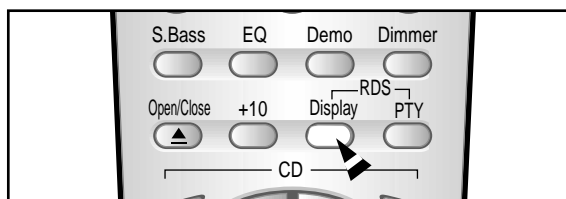

PTY(Program Type) indication and PTY-SEARCH function



- ◆ The PTY information is composed of an identification symbol, which helps the FM radio to recognize the program type of each FM station.
- ◆ The below 30 PTY information is shown on the display by pressing the Pty button.

Display	Program Type
News	• News including an announced opinion and report
Affairs	• Several matters including a current incident, documentary, discussion and analysis.
Info	• Information including weights and measures, returns and forecast, matters interesting the customer, medical information, etc.
Sport	• Sports
Educate	• Education
Drama	• Drama-Radio serial, etc.
Culture	• Culture-National or local culture including the religious problem, social science, language, theater, etc.
Science	• Natural science and technology
Varied	• Others-Speech, amusing program (quiz, game), interview, comedy and satirical play, etc.
Pop M	• Pop music
Rock M	• Rock music
M.O.R.M	• M.O.R.- Comfortable music, occasionally vocal or piece
Light M	• Light classical music- Classical music and instrumental and chorus music
Classics	• Heavy classical music-Orchestra music, symphony, chamber music and opera
Other M	• Other music - Jazz, R&B country music
Weather	• Weather
Finance	• Finance
Children	• Children's programmes
Social	• Social affairs
Religion	• Religion
Phone In	• Phone in
Travel	• Travel
Leisure	• Leisure
Jazz	• Jazz Music
Country	• Country Music
National M	• National Music
Oldies	• Oldies Music
Folk M	• Folk Music
Document	• Documentary
Test	• Alarm Test

About PTY-SEARCH

- 1 Receive the FM radio.
 - ◆ See the radio receiving method on the **page 14**.
 - ◆ The FM and frequency appear on the display.
 - ◆ If the received station is transmitting the RDS information, "RDS" lights up.
 - 2 Press the **PTY** button.
 - ◆ The PTY MODE(NEWS, AFFAIRS, etc.) appears on the display.
 - ◆ Press the TUNING ∇ or \blacktriangle button to select the desired PTY MODE.
- ◆ If the station is transmitting no PTY information, 'NO PTY' lights on the display.
- ◆ When the PTY MODE is selected(The PTY MODE is shown on the display), press the PTY KEY once again to convert into PTY-SEARCH MODE and auto-search the station sequentially.
- ◆ If the PTY MODE received in the course of auto-search agrees with the selected PTY MODE, the auto-search stops and the PTY-SEARCH is finished.
- ☞ If the PTY MODE which agrees with the PTY MODE selected in the course of auto-search, isn't received, it is returned to the first frequency at beginning the PTY SEARCH and the auto-search and PTY SEARCH are suspended.

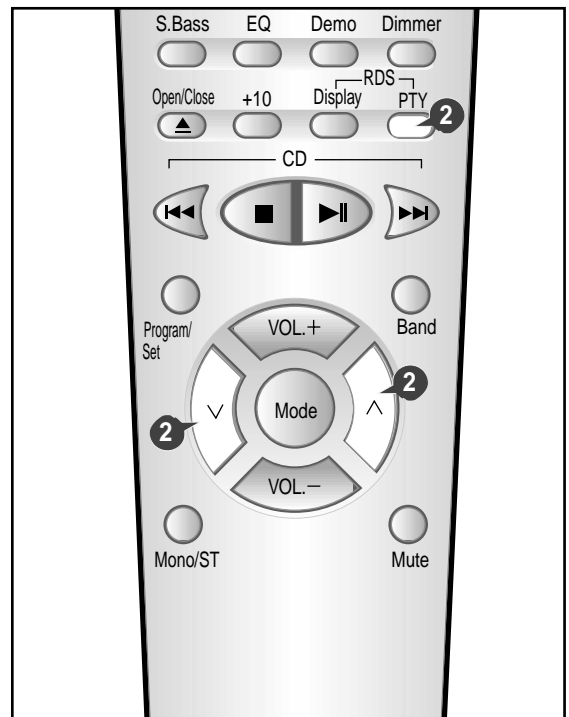

Timer Function



The timer enables you to switch the system on or off at specific times.

Example: You wish to wake up to music every morning.

- If you no longer want the system to be switched on or off automatically, you must cancel the timer.
- ◆ Before setting the timer, check that the current time is correct.
- ◆ For each step, you have a few seconds to set the required options. If you exceed this time, you must start again.

- 1 Switch the system on by pressing **On/Standby** ().
- 2 Press **Timer/Clock** until **TIMER** is displayed.
- 3 Press **Program/Set**.
Result: **ON TIME** is displayed for a few seconds, followed by any switch-on time already set; you can set the timer switch-on time.
- 4 Set the timer switch-on time.
 - a Set the hour by pressing ∇ or \blacktriangle button.
 - b Press **Program/Set**.
Result: The minutes flash.
 - c Set the minutes by pressing ∇ or \blacktriangle button.
 - d Press **Program/Set**.
Result: **OFF TIME** is displayed for a few seconds, followed by any switch-off time already set; you can now set the timer switch-off time.
- 5 Set the timer switch-off time.
 - a Set the hour by pressing ∇ or \blacktriangle button.
 - b Press **Program/Set**.
Result: The minutes flash.
 - c Set the minutes by pressing ∇ or \blacktriangle button.
 - d Press **Program/Set**.
Result: **VOL 20** is displayed, where **20** corresponds to the volume already set.
- 6 Press ∇ or \blacktriangle button to adjust the volume level and press **Program/Set**.
Result: The source to be selected is displayed.
- 7 Press ∇ or \blacktriangle button to select the source to be played when the system switches on.

If you select...	You must also...
TUNER (radio)	a Press Program/Set . b Select a preset station by pressing Tuning ∇ or \blacktriangle .
CD (compact disc)	Load a compact disc.

- 8 Press **Program/Set** to confirm the timer.
- 9 Press **On/Standby** () to set the system to standby mode.
Result: is displayed to the bottom right of the time, indicating that the timer has been set. The system will switch on and off automatically at the required times.

- ◆ If the timer switch on and off times are identical, the word **Error** is displayed.

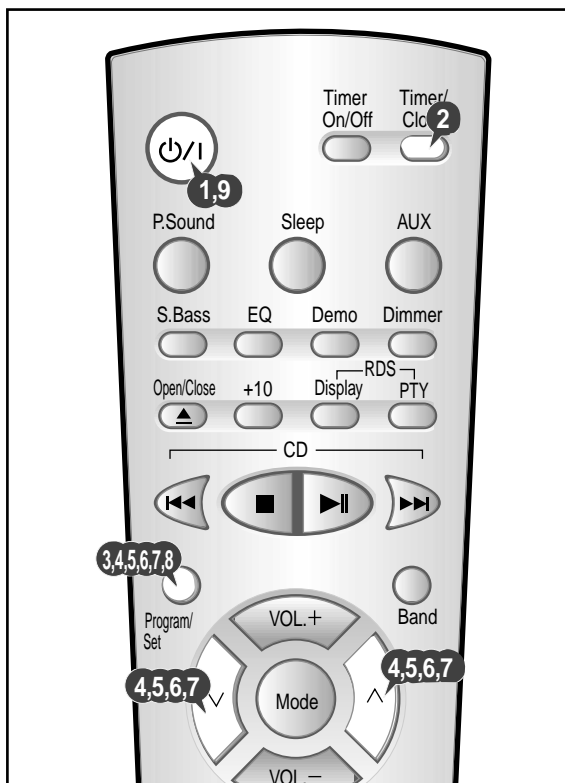

Cancelling the Timer

After having set the timer, it will start automatically as shown by the **TIMER** indication on the display. If you no longer wish to use the timer, you must cancel it.

- You can stop the timer at any time (system on or in standby mode).

To...	Press Timer On/Off...
Cancel the timer	Once. Result: is no longer displayed.
Restart the timer	Twice. Result: is displayed again.

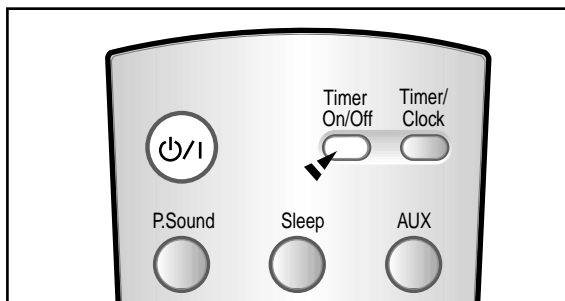

Mute Function

You can turn the sound off temporarily on your system.
Example: You wish to answer a telephone call.

- 1 Press **Mute**.
- 2 To switch the sound back on (at the same volume as before), press **Mute** again or the **Volume** buttons.

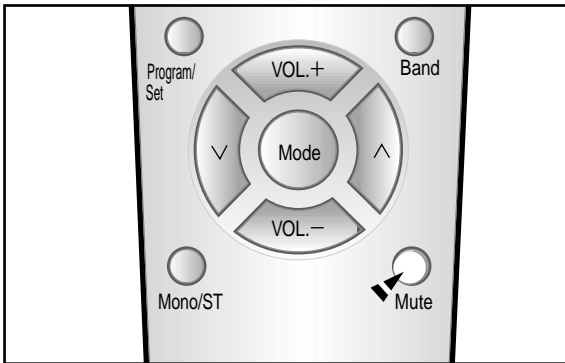

S. Bass Function

GB

S.Bass(Super Bass) function emphasizes the bass sound to produce the effect of explosion or booms.

Turn the S.Bass Level button.

- ◆ Press **S.Bass** on the remote control repeatedly to select S-Bass Off → S-Bass 1 → S-Bass 2.
- ◆ Select the desired level for the bass.

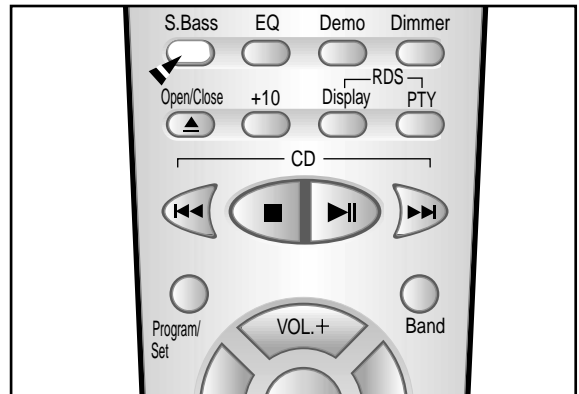

Selecting an Equalizer Preset

Your micro component system is equipped with a preset equalizer that allows you to choose the most appropriate balance between treble and bass frequencies, according to the type of music you are listening to.

Press **EQ** on the remote control until the required option is selected.

- Press the button repeatedly to select **Pass** → **Classic** → **Rock** → **Pop**.

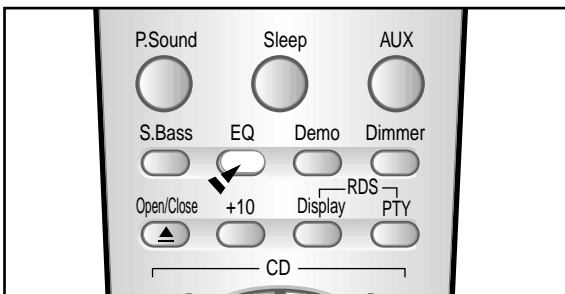

Power Sound

This machine is equipped with the function of Power Sound which amplifies bass treble output to twice as much for powerful real sound.

- 1 Press the **P. Sound** button.
 - ◆ Press the button repeatedly to select P-Sound On → P-Sound Off.
- 2 To cancel this function, press **P. Sound** button again.

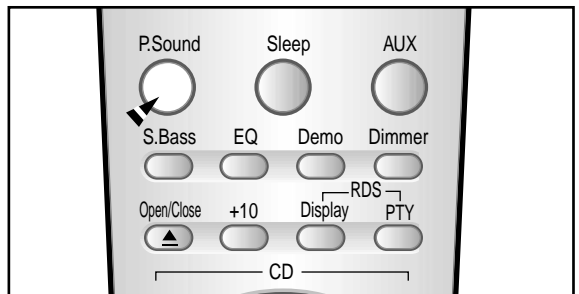

Setting the System to Switch off Automatically

GB

While listening to a compact disc or a cassette, you can set the system to switch off automatically
Example: You wish to go to sleep to music.

- Press **Sleep**.
Result: The following indications are displayed:

Sleep 90
- Press **Sleep** one or more times to indicate how long the system should continue playing before it switches off:

Sleep 90 → Sleep 60 → Sleep 45
 Sleep Off ← Sleep 10 ← Sleep 20 ← Sleep 30

➤ At any time, you can:

 - Check the remaining time by pressing **Sleep**
 - Change the remaining time by repeating Steps 1 and 2
- To cancel SLEEP function, press **Sleep** one or more times until **Sleep Off** is displayed.

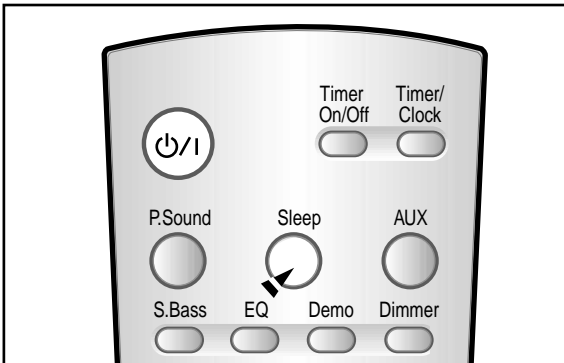

Connecting Headphones

You can connect a set of headphones to your ULTRA SLIM audio system so that you can listen to music or radio programmers without disturbing other people in the room. The earphones must have a 3.5ø jack or an appropriate adapter.

Connect the headphones to the **Phones** jack on the rear panel.
Result: The loudspeakers are no longer used to output the sound.

- Prolonged use of headphones at a high volume may damage your hearing.

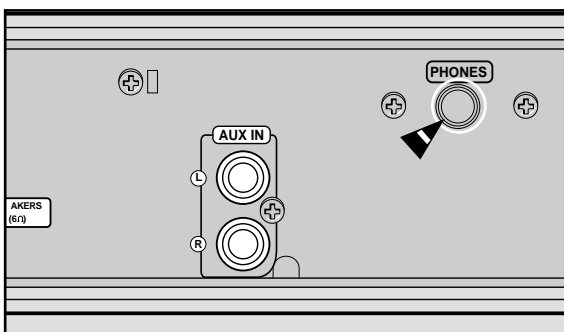

Cleaning Your ULTRA SLIM Audio System

To obtain the best possible results from your ULTRA SLIM audio system, you must clean the following elements regularly:

- ◆ The outer casing
- ◆ The compact disc player
- Always unplug the system from the wall outlet:
 - ◆ Before cleaning it
 - ◆ If you are not going to be using it for a long time

Outer Casing

Clean the outer casing regularly using a soft cloth and a light detergent. Do not use abrasive powders, liquids or aerosol cleaners. Never let any liquids get into the system.

Compact Disc Player

- Before playing a compact disc, clean it with a special CD cleaning agent. Do not use the same cleaning agents as for vinyl LP records. Carefully wipe the disc from the centre outward.
- Regularly clean the player with a special cleaning disc (available from your local dealer).

- If you will not be using the remote control for a long time, remove the batteries to prevent corrosion.
- ◆ Although your system is very hard-wearing, it should not be used in an excessively dusty environment or subjected to shocks or extreme heat (close to heating appliances or in direct sunlight, etc.).
- ◆ If the unit emits an unpleasant odor when in use, unplug it from the main supply and contact the after-sales service.

Precautions When Using Compact Discs

- ◆ Handle your compact discs with care. Always hold them by the edges to avoid leaving fingerprints on the shiny surface.
- ◆ When you have finished playing a compact disc, always put it back in its case.
- ◆ Do not fix paper or adhesive tape to the discs and do not write on the label.
- ◆ Clean them with a special-purpose cloth.
- ◆ Store your compact discs in a clean place, out of direct sunlight, where they will not be exposed to high temperatures.
- ◆ Always use compact discs marked .

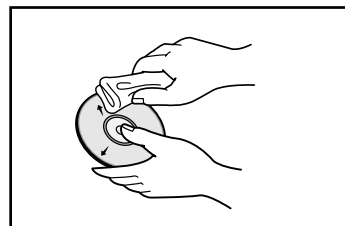

Before Contacting the After Sales Service

It always takes a little time to become familiar with a new appliance.

If you have any of the problems listed below, try the solutions given. They may save you the time and inconvenience of an unnecessary service call.

	Problem	Checks/Explanation
G E N E R A L	The system does not work	<ul style="list-style-type: none"> • The main lead is not correctly plugged into a wall socket or the wall socket is not switched on. • The remote control batteries need replacing or the polarity has not been respected. • The On/Standby button has not been pressed.
	There is no sound	<ul style="list-style-type: none"> • The volume has been completely turned down. • The correct function (TUNER, CD, AUX) has not been selected. • You have connected a set of earphones. • The loudspeaker wires have been disconnected. • The Mute button on the front panel for has been pressed.
	The Timer does not work	<ul style="list-style-type: none"> • The timer has been stopped by pressing Timer On/Off.
	In case it does not work, even the action is taken as above.	<ul style="list-style-type: none"> • Press the Mode button on the front panel for 5 seconds in power 'OFF'(standby), then it is returned the original position (RESET)
C D	The compact disc player does not start playing	<ul style="list-style-type: none"> • The CD function has not been selected. • The disc has been inserted face down or is either dirty or scratched. • The laser sensor is dirty or dusty. • The system has not been installed on a flat, horizontal surface. • Condensation has formed in the player; leave the system in a warm, airy room for at least one hour.
R A D I O	Reception is poor or no radio stations are received at all	<ul style="list-style-type: none"> • The TUNER function has not been selected. • The radio frequency has not been correctly selected. • The aerial has been disconnected or is not facing the right way. Turn it until you find the best orientation. • You are in a building that blocks radio waves; you must use an outside aerial.

If the above guidelines do not allow you to solve the problem, take a note of:

- ◆ The model and serial numbers, normally printed on the rear of the system
- ◆ Your warranty details
- ◆ A clear description of the problem

Then contact your local dealer or SAMSUNG after-sales service.

Technical Specifications

SAMSUNG strives to improve its products at all times. Both the design specifications and these user instructions are thus subject to change without notice.

RADIO

LW

Usable sensitivity 60 dB

AM (MW)

Signal/noise ratio 40 dB

Usable sensitivity 54 dB

Total harmonic distortion 2 %

FM

Signal/noise ratio 62 dB

Usable sensitivity 5 dB

Total harmonic distortion 1.0 %

COMPACT DISC PLAYER

Frequency range 20 Hz - 20 KHz (\pm 1 dB)

Signal/noise ratio 90 dB (at 1 KHz) with filter

Distortion 0.05 % (at 1 KHz)

Channel separation 75 dB

Disc sizes Diameter: 120 or 80 mm. Thickness: 1.2 mm

AMPLIFIER

Output power

◆ Main(6 Ω)2 X 30 Watts RMS (total harmonic distortion : 10%)

Channel separation 50 dB

Signal/noise ratio 75 dB

GENERAL

Dimensions 350(W) x 60 (H) x 290(D) mm

THIS APPLIANCE IS MANUFACTURED BY:

