

Notebook PC User Guide

User Guide

© Copyright 2007 Hewlett-Packard
Development Company, L.P.

Microsoft and Windows are U.S. trademarks
of Microsoft Corporation.

The information contained herein is subject
to change without notice. The only
warranties for HP products and services are
set forth in the express warranty statements
accompanying such products and services.
Nothing herein should be construed as
constituting an additional warranty. HP shall
not be liable for technical or editorial errors
or omissions contained herein.

First Edition: January 2007

Document Part Number: 436947-001

Table of contents

1 Notebook Tour

Components	1
Top components	2
Keys	2
TouchPad	3
Buttons and switches	4
Lights	5
Display components	6
Front components	6
Rear components	7
Right-side components	8
Left-side components	9
Bottom components	10
Wireless antennae (select models only)	11
Additional hardware components	12
Labels	13
Specifications	14
Operating environment	14
Rated input power	14

2 TouchPad and Keyboard

TouchPad	15
Using the TouchPad	16
Using an external mouse	16
Setting TouchPad preferences	16
Keyboard	17
Hotkeys	17
Hotkey quick reference	18
Hotkey procedures	18
Displaying and clearing system information (fn+esc)	18
Opening Help and Support (fn+f1)	19
Opening the Print Options window (fn+f2)	19
Opening a Web browser (fn+f3)	19
Switching the screen image (fn+f4)	20
Initiating Hibernation (fn+f5)	20
Initiating QuickLock (fn+f6)	21
Decreasing screen brightness (fn+f7)	21
Increasing screen brightness (fn+f8)	21
Playing, pausing or resuming an audio CD or a DVD (fn+f9)	21

Stopping an audio CD or a DVD (fn+f10)	21
Playing previous track or section of an audio CD or a DVD (fn+f11)	21
Playing next track or section of an audio CD or a DVD (fn+f12)	21
Keypads	22
Using the embedded numeric keypad	22
Enabling and disabling the embedded numeric keypad	22
Switching key functions on the embedded numeric keypad	23
Using an external numeric keypad	23
Enabling or disabling num lock mode as you work	23

3 Power management

Setting power options	24
Using power-saving states	24
Initiating and exiting Sleep	24
Initiating and exiting Hibernation	25
Using the battery meter	25
Using power plans	26
Viewing the current power plan	26
Selecting a different power plan	26
Customizing power plans	26
Setting password protection on wakeup	26
Using battery power	27
Using Battery Health in Help and Support	27
Displaying the remaining battery charge	27
Inserting or removing the battery	28
Charging a battery	29
Managing low battery levels	29
Identifying low battery levels	29
Resolving a low battery level	30
Resolving a low battery level when external power is available	30
Resolving a low battery level when a charged battery is available	30
Resolving a low battery level when no power source is available	30
Resolving a low battery level when the computer cannot exit Hibernation	30
Calibrating a battery	30
Step 1: Fully charge the battery	31
Step 2: Disable Hibernation and Sleep	31
Step 3: Discharge the battery	32
Step 4: Fully recharge the battery	32
Step 5: Reenable Hibernation and Sleep	32
Conserving battery power	33
Storing a battery	33
Disposing of a used battery	33
Using external AC power	34
Connecting the AC adapter	34
Shutting down the computer	35

4 Drives

Drive care	36
IDE drive light	37
Hard drive	38
Optical drives	41
Inserting an optical disc	42
Removing an optical disc (with power)	43
Removing an optical disc (without power)	44
Avoiding the Sleep state or Hibernation	45

5 Multimedia

Multimedia hardware	46
Using the optical drive	46
Identifying the installed optical drive	46
Inserting an optical disc	47
Removing an optical disc (with power)	48
Removing an optical disc (without power)	49
Using media activity hotkeys	50
Using the audio features	51
Using the audio-in (microphone) jack	51
Using the audio-out (headphone) jack	51
Adjusting the volume	52
Using the video features	53
Using the external monitor port	53
Using the S-Video-out jack	54
Multimedia software	55
Identifying preinstalled multimedia software	55
Installing multimedia software from a CD (select models only)	55
Using DVDPlay	55
Using multimedia software	56
Preventing playback disruptions	57
Protecting the CD or DVD write process	57
Changing DVD region settings	58
Observing the copyright warning	58

6 External Devices

Using a USB device	59
Connecting a USB device	59
Stopping a USB device	60
Required USB software	60

7 Memory Modules

Adding or replacing memory modules	61
--	----

Index	64
--------------------	-----------

1 Notebook Tour

Components

This chapter explains the hardware features of the computer.

To see a list of installed hardware in the computer:

1. Select **Start > Computer > System properties**.
2. In the left pane, click **Device Manager**.

You can also add hardware or modify device configurations using Device Manager.



NOTE Components included with the computer may vary by region and by model. The illustrations in this chapter identify the standard features included in most computer models.

Top components

Keys

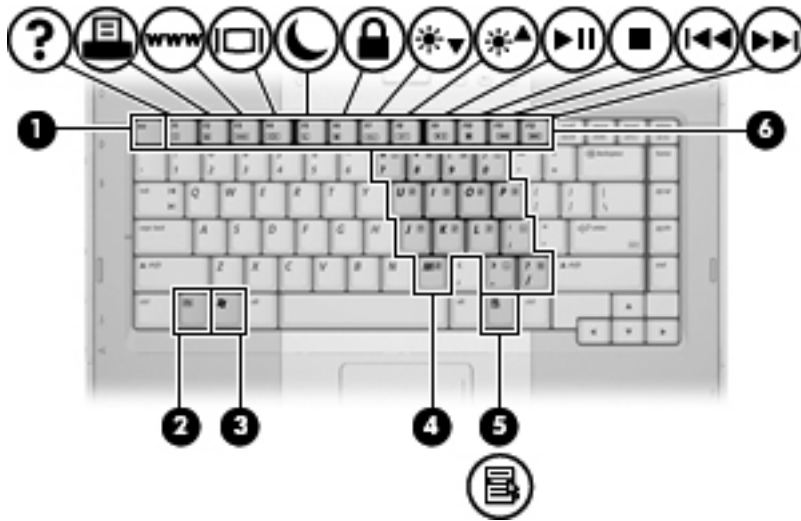

Component	Description
(1) <code>esc</code> key	Displays system information when pressed in combination with the <code>fn</code> key.
(2) <code>fn</code> key	Executes frequently used system functions when pressed in combination with a function key or the <code>esc</code> key.
(3) Windows® logo key	Displays the Windows Start menu.
(4) Embedded numeric keypad keys	Can be used like the keys on an external numeric keypad.
(5) Windows applications key	Displays a shortcut menu for items beneath the pointer.
(6) Function keys	Execute frequently used system functions when pressed in combination with the <code>fn</code> key.

TouchPad

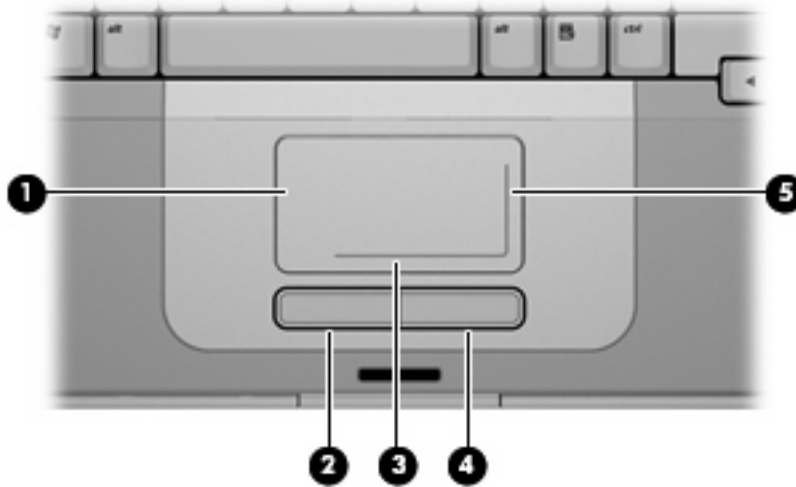

Component	Description
(1) TouchPad*	Moves the pointer and selects or activates items on the screen. Can be set to perform other mouse functions, such as scrolling, selecting, and double-clicking.
(2) Left TouchPad button*	Functions like the left button on an external mouse.
(3) TouchPad horizontal scroll zone*	Scrolls left or right.
(4) Right TouchPad button*	Functions like the right button on an external mouse.
(5) TouchPad vertical scroll zone*	Scrolls up or down.

*This table describes default settings. To view and change TouchPad preferences, select **Start > Control Panel > Hardware and Sound > Mouse**.

Buttons and switches

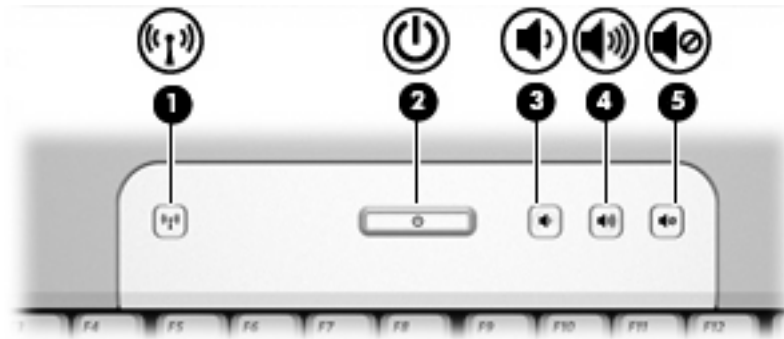

Component	Description
(1) Wireless button*	<p>Turns the wireless functionality on or off, but does not create a wireless connection.</p> <p> NOTE To establish a wireless connection, a wireless network must already be set up.</p>
(2) Power button*	<p>When the computer is off, press the power button to turn on the computer.</p> <p>If the computer has stopped responding and Windows shutdown procedures cannot be used, press and hold the power button for at least 5 seconds to turn off the computer.</p> <p>To learn more about your power settings, select Start > Control Panel > System and Maintenance > Power Options.</p>
(3) Volume down button	Decreases system volume.
(4) Volume up button	Increases system volume.
(5) Volume mute button	Mutes system sound.

*This table describes default settings.

Lights

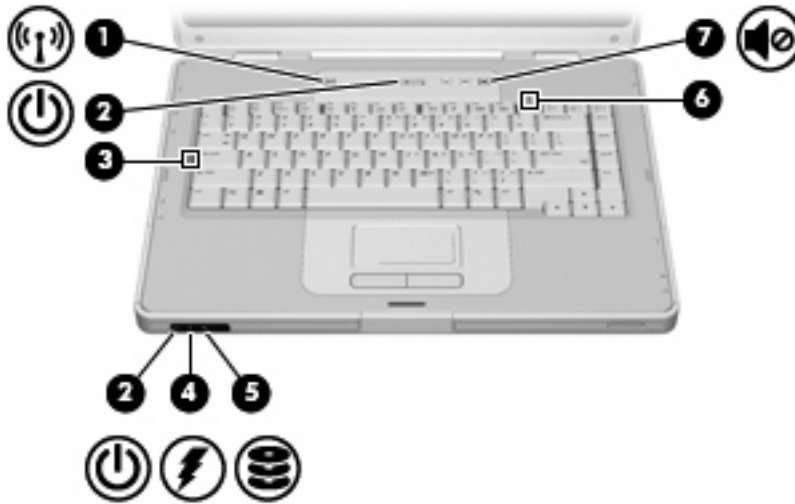

Component	Description
(1) Wireless light	On: An integrated wireless device, such as a wireless local area network (LAN), is turned on.
(2) Power lights* (2)	On: The computer is on. Blinking: The computer is in the Sleep state. Off: The computer is off or in Hibernation.
(3) Caps lock light	On: Caps lock is on.
(4) Battery light	On: A battery pack is charging or is close to full charge capacity. Blinking: A battery pack that is the only available power source has reached a low battery level. When the battery reaches a critical battery level, the battery light begins blinking rapidly. Off: If the computer is plugged into an external power source, the light is turned off when all batteries in the computer are fully charged. If the computer is not plugged into an external power source, the light stays off until the battery reaches a low battery level.
(5) IDE (Integrated Drive Electronics) drive light	Blinking: The hard drive or optical drive is being accessed.
(6) Num lock light	On: Num lock is on or the embedded numeric keypad is enabled.
(7) Volume mute light	On: System sound is turned off.

*There are 2 power lights. Both display the same information. The light on the power button is visible only when the computer is open; the other power light is always visible on the front of the computer.

Display components



Component	Description
(1) Display release button	Opens the computer.
(2) Internal display switch	Initiates Sleep if the display is closed while the notebook is turned on.

CAUTION The internal display switch is magnetic. Keep diskettes and other magnetic media away from magnetic fields, which can erase data.

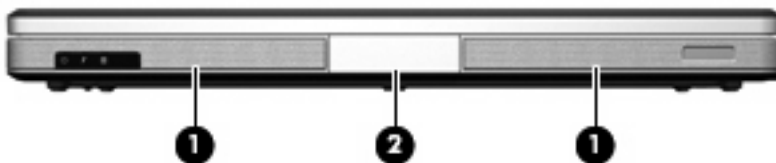

Front components



Component	Description
(1) Speakers (2)	Produce system sound.
(2) Display release button	Opens the computer.

Rear components



Component	Description
Vent*	<p data-bbox="836 443 1474 485">Provides airflow to cool internal components.</p> <p data-bbox="836 499 1474 653"> CAUTION To prevent overheating, do not obstruct vents. Use the computer only on a hard, flat surface. Do not allow another hard surface, such as an adjoining optional printer, or a soft surface, such as pillows or thick rugs or clothing, to block airflow.</p> <p data-bbox="836 674 1474 814"> NOTE The computer fan starts up automatically to cool internal components and prevent overheating. It is normal for the internal fan to cycle on and off during routine operation.</p>

*The computer has 3 vents. The other vents are located on the bottom of the computer.

Right-side components

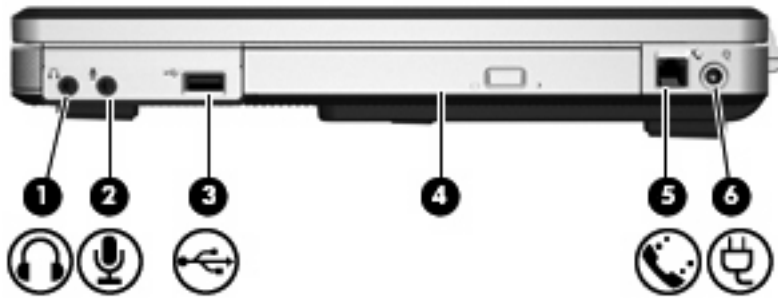

Component	Description
(1) Audio-out (headphone) jack	Produces system sound when connected to optional powered stereo speakers, headphones, ear buds, a headset, or television audio.
(2) Audio-in (microphone) jack	Connects an optional computer headset microphone or a microphone.
(3) USB port (select models only)	Connects an optional USB device.
(4) Optical drive	Reads an optical disc.
(5) RJ-11 (modem) jack	Connects an optional modem cable.
(6) Power connector	Connects an AC adapter or an optional power adapter.

Left-side components

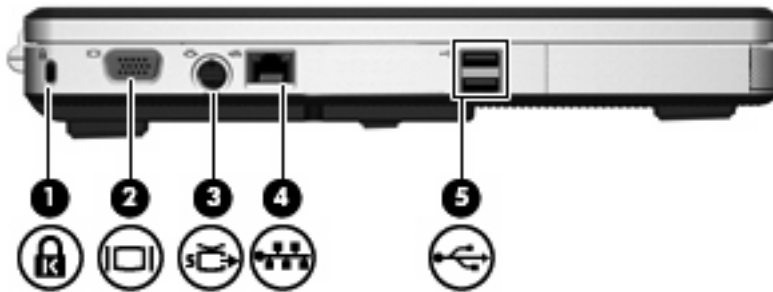

Component	Description
(1) Security cable slot	Attaches an optional security cable to the computer.  NOTE The security cable is designed to act as a deterrent, but may not prevent the computer from being mishandled or stolen.
(2) External monitor port	Connects an external monitor.
(3) S-Video-out jack	Connects an optional S-Video device such as a television, VCR, camcorder, overhead projector, or video capture card.
(4) RJ-45 (network) jack	Connects a network cable.
(5) USB ports (2)	Connect an optional USB device.

Bottom components

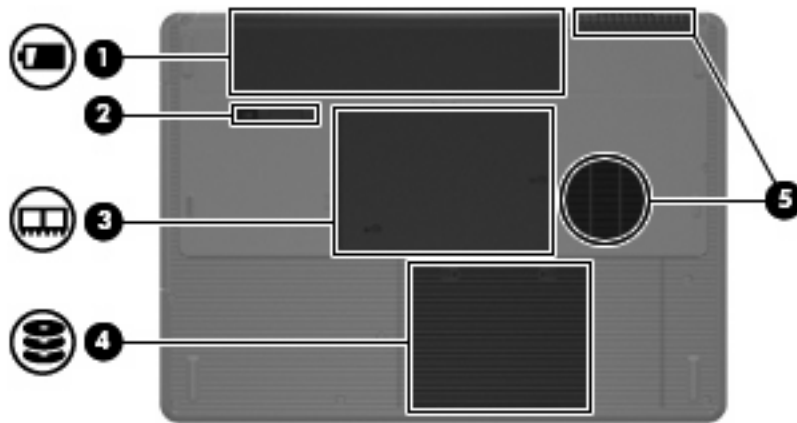

Component	Description
(1) Battery bay	Holds the primary battery pack.*
(2) Battery pack release latch	Releases the battery pack from the battery bay.
(3) Memory module compartment	Contains the memory module slots.
(4) Hard drive bay	Holds the hard drive.
(5) Vents (2)†	Enable airflow to cool internal components.

CAUTION To prevent overheating, do not obstruct vents. Use the computer only on a hard, flat surface. Do not allow another hard surface, such as an adjoining optional printer, or a soft surface, such as pillows or thick rugs or clothing, to block airflow.

NOTE The computer fan starts up automatically to cool internal components and prevent overheating. It is normal for the internal fan to cycle on and off during routine operation.

*Battery packs vary by model.

†The computer has 3 vents. One other vent is located on the rear of the computer.

Wireless antennae (select models only)

On select computer models, at least 2 wireless antennae send and receive wireless device signals. These antennae are not visible from the outside of the computer.

To see wireless regulatory notices, refer to your country's section of the *Regulatory, Safety and Environmental Notices* located in Help and Support.



NOTE For optimal transmission, keep the areas immediately around the antennae free from obstructions.

Additional hardware components



Component	Description
(1) Battery pack*	Powers the computer when the computer is not connected to external power.
(2) AC adapter	Converts AC power to DC power.
(3) Power cord*	Connects an AC adapter to an AC outlet.

*Battery packs and power cords vary in appearance by region and country.

Labels

The labels affixed to the computer provide information you may need when you troubleshoot system problems or travel internationally with the computer.

- Service tag—Provides the product name, serial number (S/N), and other specifics about the computer. Have this information available when you contact Customer Care. The service tag label is affixed to the bottom of the computer.
- Microsoft® Certificate of Authenticity—Contains the Windows Product Key. You may need the Product Key to update or troubleshoot the operating system. This certificate is affixed to the bottom of the computer.
- Regulatory label—Provides regulatory information about the computer. The regulatory label is affixed inside the battery bay.
- Modem approval label—Provides regulatory information about the modem and lists the agency approval markings required by some of the countries in which the modem has been approved for use. You may need this information when traveling internationally. The modem approval label is affixed inside the memory door.
- Wireless certification labels—Provide information about optional wireless devices available on select models, and the approval markings of some of the countries in which the devices have been approved for use. An optional device may be a wireless local area network (WLAN). If the computer model includes one or more wireless devices, a certification label is included with the computer. You may need this information when traveling internationally. Wireless certification labels are affixed inside the memory door.

Specifications

Operating environment

The operating environment information in the following table may be helpful if you plan to use or transport the computer in extreme environments.

Factor	Metric	U.S.
Temperature		
Operating	10°C to 35°C	50°F to 95°F
Nonoperating	-20°C to 60°C	-4°F to 140°F
Relative humidity (noncondensing)		
Operating	10% to 90%	10% to 90%
Nonoperating	5% to 95%	5% to 95%
Maximum altitude (unpressurized)		
Operating (14.7 to 10.1 psia*)	-15 m to 3,048 m	-50 ft to 10,000 ft
Nonoperating (14.7 to 4.4 psia*)	-15 m to 12,192 m	-50 ft to 40,000 ft

*Pounds per square inch absolute (psia) is another unit of measurement for altitude.

Rated input power

The power information in this section may be helpful if you plan to travel internationally with the computer.

The computer operates on DC power, which can be supplied by an AC or a DC power source. Although the computer can be powered from a stand-alone DC power source, it should be powered only with an AC adapter or a DC power cord supplied by or approved for this computer.

The computer is capable of accepting DC power within the following specifications.

Input Power	Rating
Operating voltage	18.5 V dc to 19.0 V dc
Operating current	3.5 A or 4.74 A

This product is designed for IT power systems in Norway with phase-to-phase voltage not exceeding 240 V rms.

2 TouchPad and Keyboard

TouchPad

The following illustration and table describe the computer TouchPad.

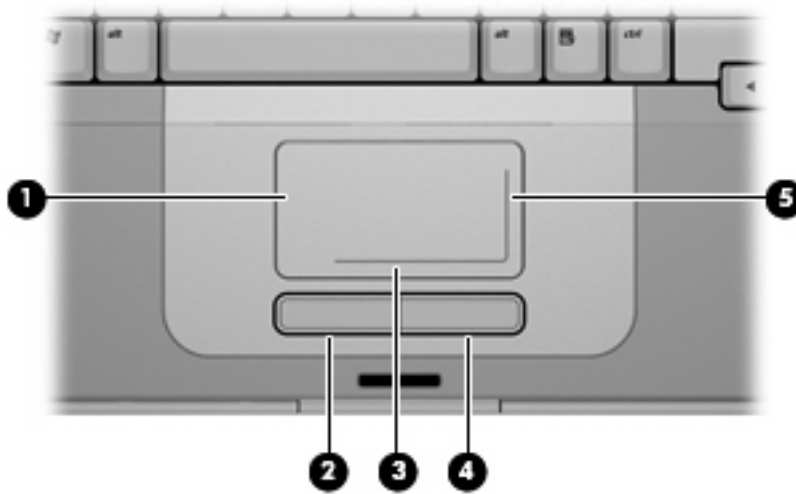

Component	Description
(1) TouchPad*	Moves the pointer and selects or activates items on the screen. Can be set to perform other mouse functions, such as scrolling, selecting, and double-clicking.
(2) Left TouchPad button*	Functions like the left button on an external mouse.
(3) TouchPad horizontal scroll zone*	Scrolls left or right.
(4) Right TouchPad button*	Functions like the right button on an external mouse.
(5) TouchPad vertical scroll zone*	Scrolls up or down.

*This table describes default settings. To view and change TouchPad preferences, select **Start > Control Panel > Hardware and Sound > Mouse**.

Using the TouchPad

To move the pointer, slide your finger across the TouchPad surface in the direction you want the pointer to go. Use the left and right TouchPad buttons as you would the left and right buttons on an external mouse. To scroll up and down using the TouchPad vertical scroll zone, slide your finger up or down over the vertical white line. To scroll left and right using the TouchPad horizontal scroll zone, slide your finger left or right over the horizontal white line.

Using an external mouse

An external USB mouse can be connected to the computer using one of the USB ports on the computer.

Setting TouchPad preferences

Mouse Properties in Windows allows you to customize settings for pointing devices, such as button configuration, click speed, and pointer options.

To access Mouse Properties, select **Start > Control Panel > Hardware and Sound > Mouse**.

Keyboard

The following sections provide information on the keyboard features of the notebook.

Hotkeys

Hotkeys are combinations of the **fn** key (1) and either the **esc** key (2) or one of the function keys (3).

The icons on the **f1** through **f12** keys represent the hotkey functions. Hotkey functions and procedures are discussed in the following sections.

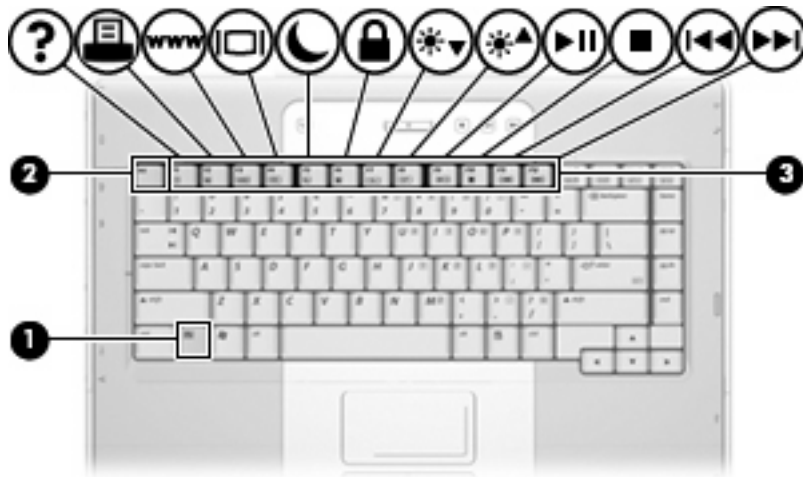

Hotkey quick reference

Function	Key Combination
Display and clear system information.	fn+esc
Open Help and Support.	fn+f1
Open the Print Options window.	fn+f2
Open a Web browser.	fn+f3
Switch the screen image between the computer display and an external display.	fn+f4
Initiate Hibernation.	fn+f5
Initiate QuickLock.	fn+f6
Decrease screen brightness.	fn+f7
Increase screen brightness.	fn+f8
Play, pause, or resume an audio CD or a DVD.	fn+f9
Stop an audio CD or a DVD.	fn+f10
Play the previous track or section on an audio CD or a DVD.	fn+f11
Play the next track on an audio CD or a DVD.	fn+f12

Hotkey procedures

To use a hotkey command on the computer keyboard, either

- Briefly press the **fn** key, and then briefly press the second key of the hotkey command.
– or –
- Press and hold down the **fn** key, briefly press the second key of the hotkey command, and then release both keys at the same time.

Displaying and clearing system information (fn+esc)

Press **fn+esc** to display information about system hardware components and the system BIOS version number. Press **fn+esc** a second time to remove the system information from the screen.

In the Windows **fn+esc** display, the version of the system BIOS (basic input-output system) is displayed as the BIOS date. On some computer models, the BIOS date is displayed in decimal format. The BIOS date is sometimes called the system ROM version number.

Opening Help and Support (fn+f1)

Press **fn+f1** to open Help and Support.

In addition to providing information about your Windows operating system, Help and Support provides

- Information about your computer, such as model and serial number, installed software, hardware components, and specifications.
- Answers to questions about using your computer.
- Tutorials to help you learn to use computer and Windows features.
- Updates for your Windows operating system, drivers, and the software provided on your computer.
- Checkups for computer functionality.
- Automated and interactive troubleshooting, repair solutions, and system recovery procedures.
- Links to support specialists.

You can also access Help and Support by selecting **Start > Help and Support**.

Opening the Print Options window (fn+f2)

Press **fn+f2** to open the Print Options window of the active Windows application.

Opening a Web browser (fn+f3)

Press **fn+f3** to open your default Web browser.

Until you have set up your Internet or network services, the **fn+f3** hotkey opens the Windows Internet Connection Wizard.

After you have set up your Internet or network services and your Web browser home page, you can press **fn+f3** to quickly access your home page and the Internet.

Switching the screen image (fn+f4)

Press **fn+f4** to switch the screen image among display devices connected to the system. For example, if a monitor is connected to the computer, each time you press **fn+f4** the image switches among the computer display, the monitor display, and a simultaneous display on both the computer and the monitor.

Most external monitors receive video information from the computer using the external VGA video standard. The **fn+f4** hotkey can also toggle images among other devices receiving video information from the computer, such as S-Video.

The following video transmission types, with examples of devices that use them, are supported by the **fn+f4** hotkey:

- LCD (computer display)
- External VGA (most external monitors)
- S-Video (televisions, camcorders, VCRs, and video capture cards with S-Video-in jacks, on select models)

Initiating Hibernation (fn+f5)

Press **fn+f5** to initiate Hibernation.

When Hibernation is initiated, your information is saved to a hibernation file on the hard drive and the computer turns off.



CAUTION To reduce the risk of information loss, save your work before initiating Hibernation.

The computer must be on before you initiate Hibernation.

To exit Hibernation, briefly press the power button.

The function of the **fn+f5** hotkey can be changed. For example, you can set the **fn+f5** hotkey to initiate Sleep instead of Hibernation.

Initiating QuickLock (fn+f6)

Press **fn+f6** to initiate the QuickLock security feature.

QuickLock protects your information by displaying the operating system Log On window. While the Log On window is displayed, the computer cannot be accessed until a Windows user password or a Windows administrator password is entered.



NOTE Before you can use QuickLock, you must set a Windows user password or a Windows administrator password. For instructions, refer to Help and Support.

To use QuickLock, press **fn+f6** to display the Log On window and lock the computer. Then follow the instructions on the screen to enter your Windows user password or your Windows administrator password and access the computer.

Decreasing screen brightness (fn+f7)

Press **fn+f7** to decrease screen brightness. Hold down the hotkey to decrease the brightness level incrementally.

Increasing screen brightness (fn+f8)

Press **fn+f8** to increase screen brightness. Hold down the hotkey to increase the brightness level incrementally.

Playing, pausing or resuming an audio CD or a DVD (fn+f9)

The **fn+f9** hotkey functions only when an audio CD or a DVD is inserted. If the audio CD or the DVD is

- Not playing, press **fn+f9** to begin or resume the play.
- Playing, press **fn+f9** to pause the play.

Stopping an audio CD or a DVD (fn+f10)

Press **fn+f10** to stop the play of an audio CD or a DVD.

Playing previous track or section of an audio CD or a DVD (fn+f11)

While an audio CD or a DVD is playing, press **fn+f11** to play the previous track of the CD or the previous section of the DVD.

Playing next track or section of an audio CD or a DVD (fn+f12)

While an audio CD or a DVD is playing, press **fn+f12** to play the next track of the CD or the next section of the DVD.

Keypads

The computer has an embedded numeric keypad and also supports an optional external numeric keypad or an optional external keyboard that includes a numeric keypad.



Component	
(1)	fn key
(2)	num lock light
(3)	num lk key
(4)	Embedded numeric keypad

Using the embedded numeric keypad

The 15 keys of the embedded numeric keypad can be used like the keys on an external keypad. When the embedded numeric keypad is turned on, each key on the keypad performs the function indicated by the icon in the upper-right corner of the key.

Enabling and disabling the embedded numeric keypad

Press **fn+num lk** to enable the embedded numeric keypad. The num lock light turns on. Press **fn+num lk** again to return the keys to their standard keyboard functions. The num lock light turns off.



NOTE The embedded numeric keypad will not function while an external keyboard or keypad is connected to the computer.

Switching key functions on the embedded numeric keypad

You can temporarily alternate the functions of keys on the embedded numeric keypad between their standard keyboard functions and their keypad functions by using the **fn** key or the **fn+shift** key combination.

- To change the function of a keypad key to keypad functions while the keypad is off, press and hold the **fn** key while pressing the keypad key.
- To use the keypad keys temporarily as standard keys while the keypad is on:
 - Press and hold the **fn** key to type in lowercase.
 - Press and hold **fn+shift** to type in uppercase.

Using an external numeric keypad

Most keys on most external keypads function differently according to whether num lock mode is on or off. (By default num lock mode is off.) For example:

- When num lock is on, most keypad keys type numbers.
- When num lock is off, most keypad keys function like the arrow, page up, or page down keys.

When num lock on an external keypad is turned on, the num lock light on the computer is turned on. When num lock on an external keypad is turned off, the num lock light on the computer is turned off.

If an external keypad is connected, the embedded numeric keypad cannot be turned on.

Enabling or disabling num lock mode as you work

To turn num lock on or off on an external keypad as you work, press the **num lk** key on the external keypad, not on the computer.

3 Power management

Setting power options

Using power-saving states

Windows has two power-saving states enabled at the factory: Sleep and Hibernation.

When you initiate Sleep, the power lights blink and the screen clears. Your work is saved to memory, letting you exit Sleep faster than exiting Hibernation. If the computer is in the Sleep state for an extended period or if the battery reaches a critical battery level while in the Sleep state, the computer initiates Hibernation.

When you initiate Hibernation, your work is saved to a hibernation file on the hard drive and the computer turns off.



CAUTION To prevent possible audio and video degradation, or loss of audio or video playback functionality, or loss of information, do not initiate Sleep or Hibernation while reading from or writing to a disc or an external media card.



NOTE You cannot initiate any type of networking communications or perform any computer functions while the computer is in the Sleep state or in Hibernation.

Initiating and exiting Sleep

The system is set at the factory to initiate Sleep after 10 minutes of inactivity when running on battery power and 25 minutes of inactivity when running on external power.

Power settings and timeouts can be changed using Power Options in Windows Control Panel.

With the computer on, you can initiate Sleep in any of the following ways:

- Press the power button.
- Close the display.
- Click **Start**, and then click the **Power** button.
- Click **Start**, click the arrow next to the Lock button, and then click **Sleep**.

You can exit Sleep in any of the following ways:

- Press the power button.
- If the display is closed, open the display.

- Press a key on the keyboard.
- Activate the TouchPad.

When the computer exits Sleep, the power lights turn on and your work returns to the screen where you stopped working.



NOTE If you have set a password to be required on wakeup, you must enter your Windows password before your work will return to the screen.

Initiating and exiting Hibernation

The system is set at the factory to initiate Hibernation after 120 minutes of inactivity when running on battery power, 1080 minutes (18 hours) of inactivity when running on external power, or when the battery reaches a critical battery level.

Power settings and timeouts can be changed using Power Options in Windows Control Panel.

To initiate Hibernation:

1. Click **Start**, and then click the arrow next to the Lock button.
2. Click **Hibernate**.

– or –

- ▲ Press **fn+f5**.

To exit Hibernation:

- ▲ Press the power button.

The power lights turn on and your work returns to the screen where you stopped working.



NOTE If you have set a password to be required on wakeup, you must enter your Windows password before your work will return to the screen.

Using the battery meter

The battery meter is located in the notification area at the far right of the taskbar. The battery meter allows you to quickly access power settings, view remaining battery charge, and select a different power plan.

- To display the percentage of remaining battery charge and the current power plan, move the pointer over the battery meter icon.
- To access Power Options, or to change the power plan, click the battery meter icon and select an item from the list.

Different battery meter icons indicate whether the computer is running on battery or external power. The icon also displays a message if the battery has reached a critical battery level.

To hide or display the battery meter icon:

1. Right-click the taskbar, and then click **Properties**.
2. Click the **Notification Area** tab.

3. Under **System icons**, clear the **Power** check box to hide the battery meter icon, or select the **Power** check box to display the battery meter icon.
4. Click **OK**.

Using power plans

A power plan is a collection of system settings that manages how the computer uses power. Power plans can help you conserve power or maximize performance.

You can change power plan settings or create your own power plan.

Viewing the current power plan

- ▲ Move the pointer over the battery meter icon in the notification area, at the far right of the taskbar.
– or –
Select **Start > Control Panel > System and Maintenance > Power Options**.

Selecting a different power plan

- ▲ Click the battery meter icon in the notification area, and then select a power plan from the list.
– or –
Select **Start > Control Panel > System and Maintenance > Power Options**, and then select a power plan from the list.

Customizing power plans

1. Click the battery meter icon in the notification area, and then click **More power options**.
– or –
Select **Start > Control Panel > System and Maintenance > Power Options**.
2. Select a power plan, and then click **Change plan settings**.
3. Change the **Turn off the display** and **Put the computer to sleep** timeout settings, as needed.
4. To change additional settings, click **Change advanced power settings** and make your changes.

Setting password protection on wakeup

To set the computer to prompt for a password when the computer exits Sleep or Hibernation, follow these steps:

1. Select **Start > Control Panel > System and Maintenance > Power Options**.
2. In the left pane, click **Require a password on wakeup**.
3. Click **Change Settings that are currently unavailable**.
4. Click **Require a password (recommended)**.
5. Click **Save changes**.

Using battery power

When a charged battery is in the computer and the computer is not plugged into external power, the computer runs on battery power. When the computer is plugged into external AC power, the computer runs on AC power.

If the computer contains a charged battery and is running on external AC power supplied through the AC adapter, the computer switches to battery power if the AC adapter is disconnected from the computer.



NOTE The display brightness is decreased to save battery life when you disconnect AC power. To increase display brightness, use the **fn+f8** hotkey or reconnect the AC adapter.

You can keep a battery in the computer or in storage, depending on how you work. Keeping the battery in the computer whenever the computer is plugged into AC power charges the battery and also protects your work in case of a power outage. However, a battery in the computer slowly discharges when the computer is off and unplugged from external power.



WARNING! To reduce potential safety issues, use only the battery provided with the computer, a replacement battery provided by HP, or a compatible battery purchased from HP.

Computer battery life varies, depending on power management settings, programs running on the computer, display brightness, external devices connected to the computer, and other factors.

Using Battery Health in Help and Support

The Battery Health section of the Help and Support Learning Center provides the following tools and information:

- Battery Check tool to test battery performance
- Information on calibration, power management, and proper care and storage to maximize battery life
- Information on battery types, specifications, life cycles, and capacity

To access Battery Health:

- ▲ Select **Start > Help and Support > Learning Center > Battery Health**.

Displaying the remaining battery charge

- ▲ Move the pointer over the battery meter icon in the notification area, at the far right of the taskbar.

– or –

View the estimated number of minutes of battery charge remaining in Windows Mobility Center:

- ▲ Click the battery meter icon, and then click **Windows Mobility Center**.

– or –

Select **Start > Control Panel > Mobile PC > Windows Mobility Center**.

The time shown indicates the approximate running time remaining on the battery *if the battery continues to provide power at the current level*. For example, the time remaining will decrease when a DVD is playing and will increase when a DVD stops playing.

Inserting or removing the battery

 **CAUTION** To prevent loss of information when removing a battery that is the sole power source, initiate Hibernation or turn off the computer before removing the battery.

To insert the battery:

1. Turn the computer upside down on a flat surface, with the battery bay toward you.
2. Insert the battery into the battery bay (1) and rotate it downward until it is seated (2).

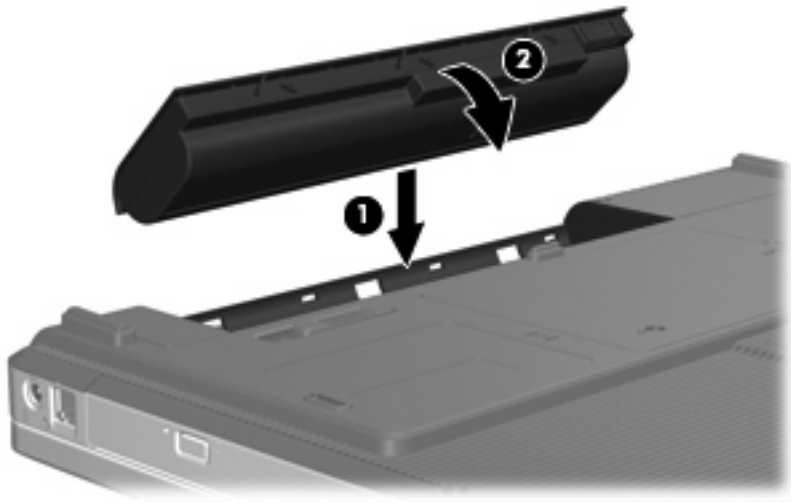

To remove the battery:

1. Turn the computer upside down on a flat surface, with the battery bay toward you.
2. Slide the battery release latch (1) to release the battery.
3. Pivot the battery (2) away from the computer and remove it (3).

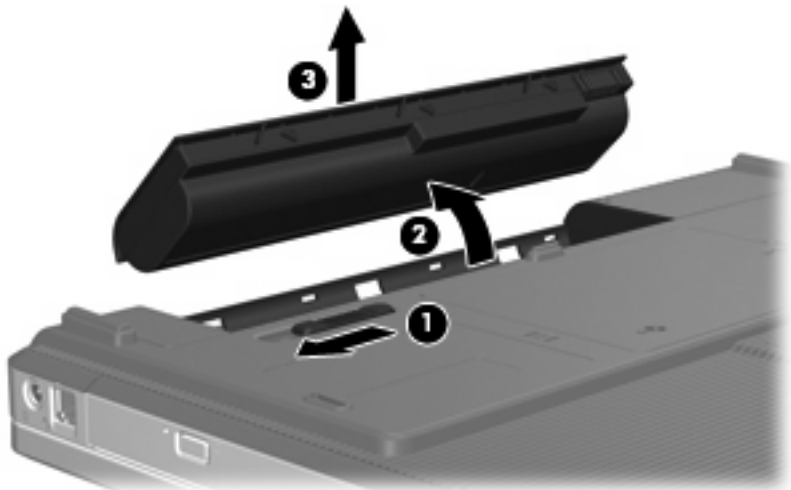

Charging a battery



WARNING! Do not charge the computer battery while you are onboard aircraft.

The battery charges whenever the computer is plugged into external power through an AC adapter, an optional power adapter, an optional expansion product, or an optional docking device.

The battery charges whether the computer is off or in use, but it charges faster when the computer is off.

Charging may take longer if a battery is new, has been unused for 2 weeks or more, or is much warmer or cooler than room temperature.

To prolong battery life and optimize the accuracy of battery charge displays, follow these recommendations:

- If you are charging a new battery, charge it fully before turning on the computer.
- Charge the battery until the battery light turns off.



NOTE If the computer is on while the battery is charging, the battery meter in the notification area may show 100 percent charge before the battery is fully charged.

- Allow the battery to discharge below 5 percent of a full charge through normal use before charging it.
- If the battery has been unused for one month or more, calibrate the battery instead of simply charging it.

The battery light displays charge status:

- On: The battery is charging.
- Blinking: The battery has reached a low battery level and is not charging.
- Off: The battery is fully charged, in use, or not installed.

Managing low battery levels

The information in this section describes the alerts and system responses set at the factory. Some low battery alerts and system responses can be changed using Power Options in Windows Control Panel. Preferences set using Power Options do not affect lights.

Identifying low battery levels

When a battery that is the sole power source for the computer reaches a low battery level, the battery light blinks.

If a low battery level is not resolved, the computer enters a critical battery level, and the battery light continues to blink.

The computer takes the following actions for a critical battery level:

- If Hibernation is enabled and the computer is on or in the Sleep state, the computer initiates Hibernation.
- If Hibernation is disabled and the computer is on or in the Sleep state, the computer remains briefly in the Sleep state, and then shuts down and loses any unsaved information.

Resolving a low battery level



CAUTION To reduce the risk of losing information when the computer reaches a critical battery level and has initiated Hibernation, do not restore power until the power lights turn off.

Resolving a low battery level when external power is available

Connect one of the following devices:

- AC adapter
- Optional expansion product or docking device
- Optional power adapter

Resolving a low battery level when a charged battery is available

1. Turn off the computer or initiate Hibernation.
2. Remove the discharged battery, and then insert a charged battery.
3. Turn on the computer.

Resolving a low battery level when no power source is available

- ▲ Initiate Hibernation.

– or –

Save your work and shut down the computer.

Resolving a low battery level when the computer cannot exit Hibernation

When the computer lacks sufficient power to exit Hibernation, follow these steps:

1. Insert a charged battery or plug the computer into external power.
2. Exit Hibernation by pressing the power button.

Calibrating a battery

Calibrate a battery under the following conditions:

- When battery charge displays seem inaccurate
- When you observe a significant change in battery run time

Even if a battery is heavily used, it should not need to be calibrated more than once a month. It is also not necessary to calibrate a new battery.

Step 1: Fully charge the battery



WARNING! Do not charge the computer battery while you are onboard aircraft.



NOTE The battery charges whether the computer is off or in use, but it charges faster when the computer is off.

To fully charge the battery:

1. Insert the battery into the computer.
2. Connect the computer to an AC adapter, optional power adapter, optional expansion product, or optional docking device, and then plug the adapter or device into external power.

The battery light on the computer turns on.

3. Leave the computer plugged into external power until the battery is fully charged.

The battery light on the computer turns off.

Step 2: Disable Hibernation and Sleep

1. Click the battery meter icon in the notification area, and then click **More power options**.

– or –

Select **Start > Control Panel > System and Maintenance > Power Options**.

2. Under the current power plan, click **Change plan settings**.
3. Record the **Turn off the display** and **Put the computer to sleep** settings listed in the **On battery** column so that you can reset them after the calibration.
4. Change the **Turn off the display** and **Put the computer to sleep** settings to **Never**.
5. Click **Change advanced power settings**.
6. Click the plus sign next to **Sleep**, and then click the plus sign next to **Hibernate after**.
7. Record the **On battery** setting under **Hibernate after** so that you can reset it after the calibration.
8. Type *Never* in the **On battery** box.
9. Click **OK**.
10. Click **Save changes**.

Step 3: Discharge the battery

The computer must remain on while the battery is being discharged. The battery can discharge whether or not you are using the computer, but the battery will discharge faster while you are using it.

- If you plan to leave the computer unattended during the discharge, save your information before beginning the discharge procedure.
- If you use the computer occasionally during the discharge procedure and have set energy-saving timeouts, expect the following performance from the system during the discharge process:
 - The monitor will not turn off automatically.
 - Hard drive speed will not decrease automatically when the computer is idle.
 - System-initiated Hibernation will not occur.

To discharge a battery:

1. Unplug the computer from its external power source, but do not turn off the computer.
2. Run the computer on battery power until the battery is discharged. The battery light begins to blink when the battery has discharged to a low battery level. When the battery is discharged, the battery light turns off and the computer shuts down.

Step 4: Fully recharge the battery

To recharge the battery:

1. Plug the computer into external power and maintain external power until the battery is fully recharged. When the battery is recharged, the battery light on the computer turns off.

You can use the computer while the battery is recharging, but the battery will charge faster if the computer is off.

2. If the computer is off, turn it on when the battery is fully charged and the battery light has turned off.

Step 5: Reenable Hibernation and Sleep



CAUTION Failure to reenable Hibernation after calibration may result in a full battery discharge and information loss if the computer reaches a critical battery level.

1. Click the battery meter icon in the notification area, and then click **More power options**.

– or –

Select **Start > Control Panel > System and Maintenance > Power Options**.

2. Under the current power plan, click **Change plan settings**.
3. Reenter the settings that you recorded for the items in the **On battery** column.
4. Click **Change advanced power settings**.
5. Click the plus sign next to **Sleep**, and then click the plus sign next to **Hibernate after**.
6. Reenter the setting that you recorded for **On battery**.

7. Click **OK**.
8. Click **Save changes**.

Conserving battery power

- Select low power-use settings through Power Options in Windows Control Panel.
- Turn off wireless and local area network (LAN) connections and exit modem applications when you are not using them.
- Disconnect external devices that are not plugged into an external power source, when you are not using them.
- Stop, disable, or remove any external media cards that you are not using.
- Using the **fn+f7** and **fn+f8** hotkeys to adjust screen brightness as needed.
- If you leave your work, initiate Sleep or Hibernation, or shut down the computer.

Storing a battery



CAUTION To prevent damage to a battery, do not expose it to high temperatures for extended periods of time.

If a computer will be unused and unplugged from external power for more than 2 weeks, remove the battery and store it separately.

To prolong the charge of a stored battery, place it in a cool, dry place.

Calibrate a battery before using it if it has been stored for one month or more.

Disposing of a used battery



WARNING! To reduce the risk of fire or burns, do not disassemble, crush, or puncture a battery; short the external contacts on a battery; or dispose of a battery in fire or water. Do not expose a battery to temperatures above 60°C (140°F). Replace the battery only with a battery approved for this computer.

Refer to the *Regulatory, Safety and Environmental Notices* for battery disposal information.

Using external AC power

External AC power is supplied through one of the following devices:



WARNING! To reduce potential safety issues, use only the AC adapter provided with the computer, a replacement AC adapter provided by HP, or a compatible AC adapter purchased from HP.

- AC adapter included with the computer
- Optional docking device or expansion product
- Optional power adapter

Connect the computer to external AC power under any of the following conditions:

- When you are charging or calibrating a battery



WARNING! Do not charge the computer battery while you are onboard aircraft.

- When you are installing or modifying system software
- When you are writing information to a CD or DVD

When you connect the computer to external AC power, the following events occur:

- The battery begins to charge.
- If the computer is turned on, the battery meter icon in the notification area changes appearance.

When you disconnect external AC power, the following events occur:

- The computer switches to battery power.
- The display brightness is automatically decreased to save battery life. To increase display brightness, press the **fn+f8** hotkey or reconnect the AC adapter.

Connecting the AC adapter



WARNING! To reduce the risk of electric shock or damage to the equipment:

Plug the power cord into an AC outlet that is easily accessible at all times.

Disconnect power from the computer by unplugging the power cord from the AC outlet (not by unplugging the power cord from the computer).

If provided with a 3-pin attachment plug on the power cord, plug the cord into a grounded (earthed) 3-pin outlet. Do not disable the power cord grounding pin, for example, by attaching a 2-pin adapter. The grounding pin is an important safety feature.

To connect the computer to external AC power:

1. Plug the AC adapter into the power connector **(1)** on the computer.
2. Plug the power cord into the AC adapter **(2)**.

3. Plug the other end of the power cord into the AC outlet (3).



Shutting down the computer

 **CAUTION** Unsaved information will be lost when the computer is shut down.

The Shut Down command closes all open programs, including the operating system, and then turns off the display and computer.

Shut down the computer under any of the following conditions:

- When you need to replace the battery or access components inside the computer
- When you are connecting an external hardware device that does not connect to a USB port
- When the computer will be unused and disconnected from external power for an extended period

To shut down the computer:



NOTE If the computer is in the Sleep state or in Hibernation, you must first exit Sleep or Hibernation before shutdown is possible.

1. Save your work and close all open programs.
2. Click **Start**, and then click the arrow next to the Lock button.
3. Click **Shut Down**.

If the computer is unresponsive and you are unable to use the preceding shutdown procedures, try the following emergency procedures in the sequence provided:

- Press **ctrl+alt+delete**, and then click the **Power** button.
- Press and hold the power button for at least 5 seconds.
- Disconnect the computer from external power and remove the battery.

4 Drives

Drive care

Drives are fragile computer components that must be handled with care. The following cautions apply to all drives. Additional cautions are included with the procedures to which they apply.



CAUTION To reduce the risk of damage to the computer, damage to a drive, or loss information, observe these precautions:

Initiate Sleep before you move a computer or external hard drive from one location to another.

Before handling a drive, discharge static electricity by touching the unpainted metal surface of the drive.

Do not touch the connector pins on a removable drive or on the computer.

Handle a drive carefully; do not drop or compress the drive.

Before removing or inserting a drive, shut down the computer. If you are unsure whether the computer is off or in Hibernation, turn the computer on, and then shut it down through the operating system.

Do not use excessive force when inserting a drive into a drive bay.

Do not type on the keyboard or move the computer when the drive is writing to media. The write process is sensitive to vibration.

When the battery pack is the only source of power, ensure that the battery pack is sufficiently charged before writing to media.

Avoid exposing a drive to temperature or humidity extremes.

Avoid exposing a drive to liquids. Do not spray it with cleaning products.

Remove media from a drive before removing the drive from the drive bay, or traveling with, shipping, or storing a drive.

If a drive must be mailed, place the drive in a bubble-pack mailer or other suitable protective packaging and label the package “FRAGILE.”

Avoid exposing a drive to magnetic fields. Security devices with magnetic fields include airport walk-through devices and security wands. The airport security devices that check carry-on luggage, such as conveyor belts, use x-rays instead of magnetism and will not damage a drive.

IDE drive light

The IDE drive light blinks when either the primary hard drive or an optical drive is being accessed.

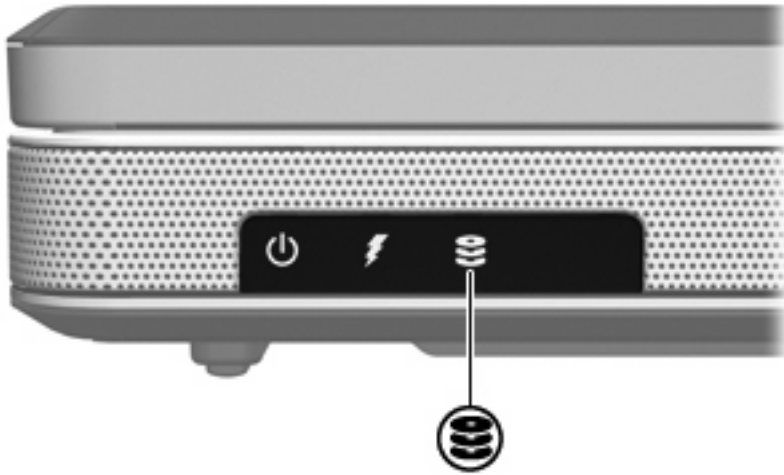

Hard drive

 **CAUTION** To prevent system lockup and loss of information:

Shut down the computer before removing the hard drive from the hard drive bay. Do not remove the hard drive while the computer is on, in the Sleep state, or in Hibernation.

If you are not sure whether the computer is off or in Hibernation, turn the computer on by pressing the power button. Then shut down the computer through the operating system.

To remove the hard drive:

1. Save your work.
2. Shut down the computer and close the display.
3. Turn the computer upside down, with the hard drive bay toward you.
4. Loosen the 2 hard drive cover screws (1).
5. Lift the hard drive cover away from the computer (2).

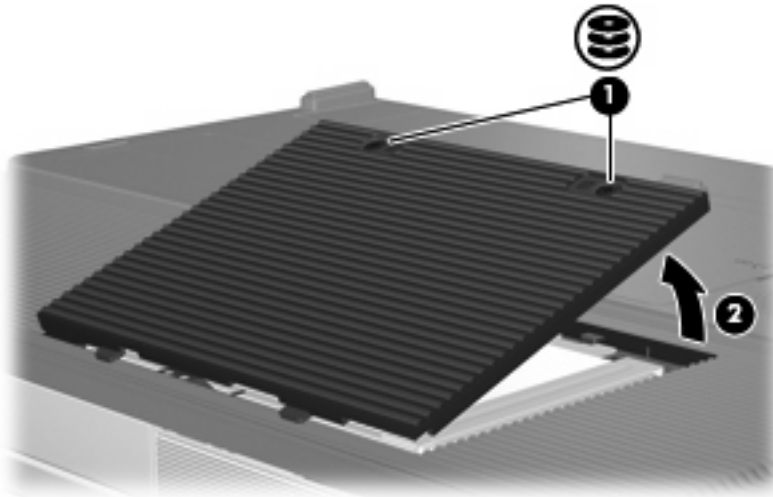

6. Disconnect the hard drive (1) by sliding it to the right.

7. Lift the hard drive away from the computer (2).

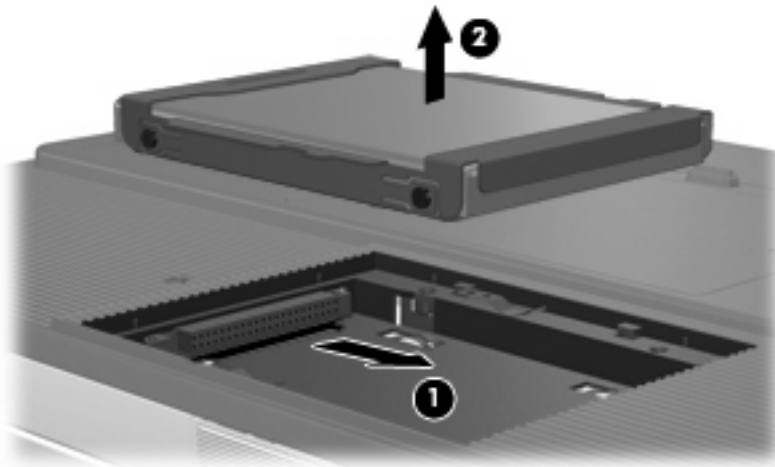

To install a hard drive:

1. Lower the hard drive into the hard drive bay (1).
2. Slide the hard drive toward the hard drive connector (2) until it is fully seated.

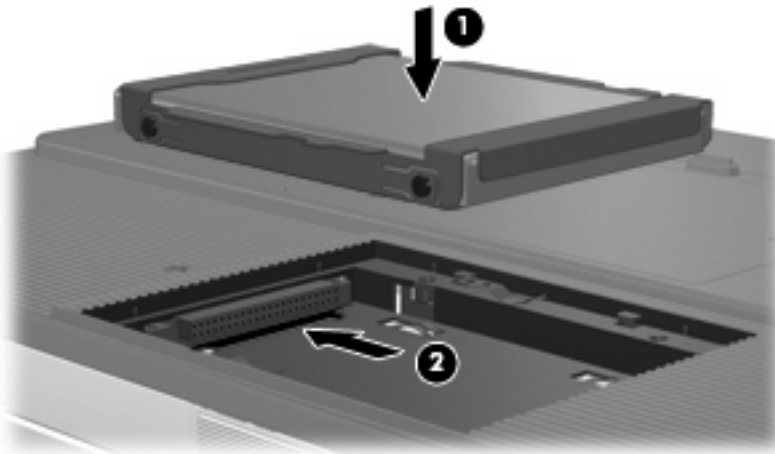

3. Align the tabs (1) on the hard drive cover with the notches on the computer.
4. Close the cover (2).

5. Tighten the hard drive cover screws (3).

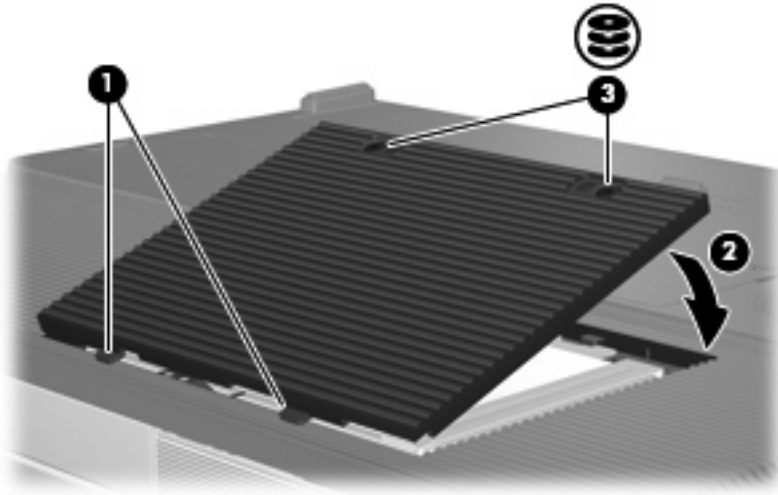

Optical drives

An optical drive, such as a DVD-ROM drive, supports optical discs (CDs and DVDs). These discs are used to store or transport data and to play music and movies. DVDs have a higher capacity than CDs.

The computer can read or write to optical drives as described in the following table.

Type of Optical Drive	Read CD and DVD-ROM	Write to CD-RW	Write to DVD ±RW/R	LightScribe
DVD/CD-RW Drive	Yes	Yes	No	No
DVD±RW Double Layer	Yes	Yes	Yes	No
LightScribe DVD±RW Double Layer	Yes	Yes	Yes	Yes



NOTE Some of the optical drives listed may not be supported by your computer. The listed drives are not necessarily all of the supported optical drives.

Inserting an optical disc

1. Turn on the computer.
2. Press the release button **(1)** on the drive bezel to release the media tray.
3. Pull out the tray **(2)**.
4. Hold the CD or DVD by the edges to avoid touching the flat surfaces, and position the disc over the tray spindle, with the label-side up.



NOTE If the tray is not fully accessible, tilt the disc carefully to position it over the spindle.

5. Gently press the disc **(3)** down onto the tray spindle until the disc snaps into place.

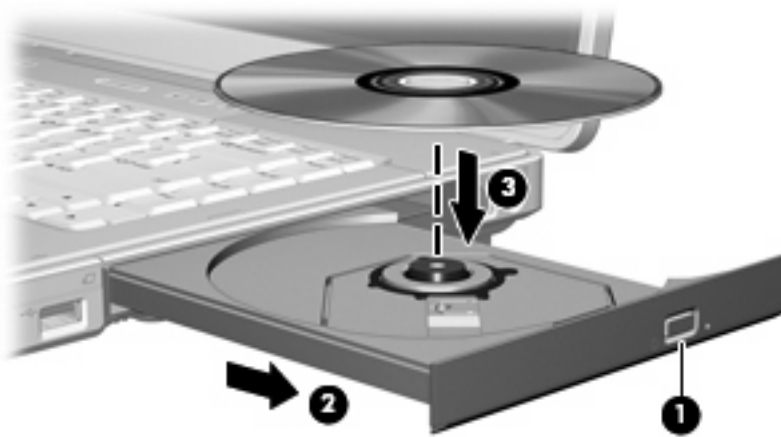

6. Close the media tray.



NOTE After you insert a disc, a short pause is normal. If you have not selected a default media player, an AutoPlay dialog box opens. It prompts you to select how you want to use the media content.

Removing an optical disc (with power)

If the computer is running on external or battery power:

1. Turn on the computer.
2. Press the release button **(1)** on the drive bezel to release the media tray, and then pull out the tray **(2)**.
3. Remove the disc **(3)** from the tray by gently pressing down on the spindle while lifting the outer edges of the disc. Hold the disk by the edges and avoid touching the flat surfaces.



NOTE If the tray is not fully accessible, tilt the disc carefully as you remove it.

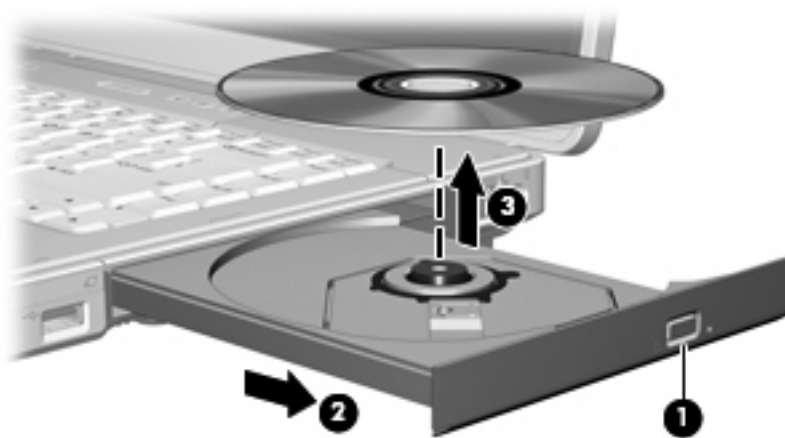

4. Close the media tray and place the disc in a protective case.

Removing an optical disc (without power)

If external or battery power is unavailable:

1. Insert the end of a paper clip (1) into the release access in the front bezel of the drive.
2. Press in gently until the tray is released, and then pull out the tray (2).
3. Remove the disc (3) from the tray by gently pressing down on the spindle while lifting the outer edges of the disc. Hold the disk by the edges and avoid touching the flat surfaces.



NOTE If the tray is not fully accessible, tilt the disc carefully as you remove it.



4. Close the media tray and place the disc in a protective case.

Avoiding the Sleep state or Hibernation



CAUTION To prevent possible audio and video degradation, or loss of audio or video playback functionality, do not initiate Sleep or Hibernation while reading or writing to a CD or DVD.

To prevent loss of information, do not initiate Sleep or Hibernation when writing to a CD or DVD.

If Sleep or Hibernation is initiated during playback of drive media (such as a CD or DVD):

- Your playback may be interrupted.
- You may see a warning message asking if you want to continue. If this message is displayed, click **No**.
- You may need to restart the CD or DVD to resume audio and video playback.

5 Multimedia

Multimedia hardware

Using the optical drive

The optical drive allows you to play, copy, and create CDs or DVDs, depending on the type of installed drive and installed software.

Identifying the installed optical drive

To view the type of optical drive installed in the computer:

- ▲ Select **Start > Computer**.

Inserting an optical disc

1. Turn on the computer.
2. Press the release button **(1)** on the drive bezel to release the media tray.
3. Pull out the tray **(2)**.
4. Hold the CD or DVD by the edges to avoid touching the flat surfaces, and position the disc over the tray spindle, with the label-side up.



NOTE If the tray is not fully accessible, tilt the disc carefully to position it over the spindle.

5. Gently press the disc **(3)** down onto the tray spindle until the disc snaps into place.

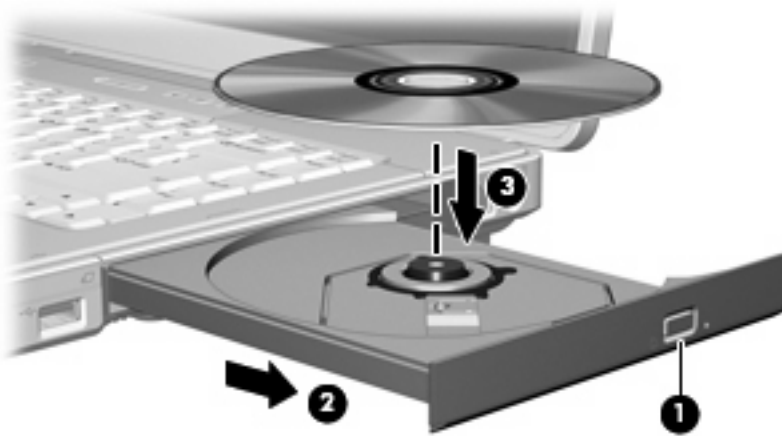

6. Close the media tray.



NOTE After you insert a disc, a short pause is normal. If you have not selected a default media player, an AutoPlay dialog box opens. It prompts you to select how you want to use the media content.

Removing an optical disc (with power)

If the computer is running on external or battery power:

1. Turn on the computer.
2. Press the release button (1) on the drive bezel to release the media tray, and then pull out the tray (2).
3. Remove the disc (3) from the tray by gently pressing down on the spindle while lifting the outer edges of the disc. Hold the disk by the edges and avoid touching the flat surfaces.

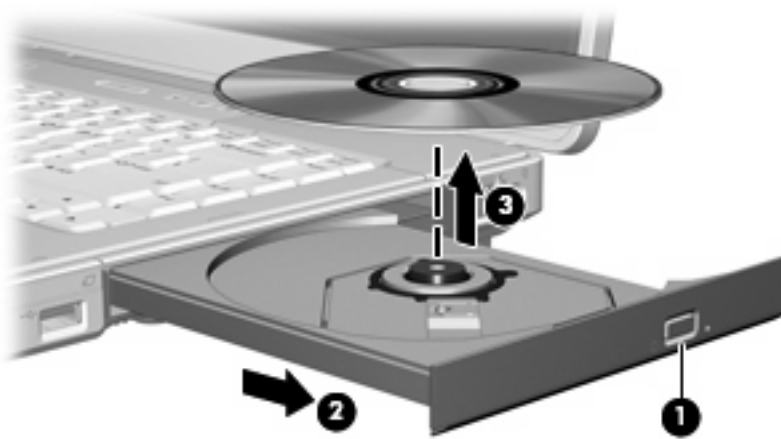

NOTE If the tray is not fully accessible, tilt the disc carefully as you remove it.

4. Close the media tray and place the disc in a protective case.

Removing an optical disc (without power)

If external or battery power is unavailable:

1. Insert the end of a paper clip (1) into the release access in the front bezel of the drive.
2. Press in gently until the tray is released, and then pull out the tray (2).
3. Remove the disc (3) from the tray by gently pressing down on the spindle while lifting the outer edges of the disc. Hold the disk by the edges and avoid touching the flat surfaces.



NOTE If the tray is not fully accessible, tilt the disc carefully as you remove it.

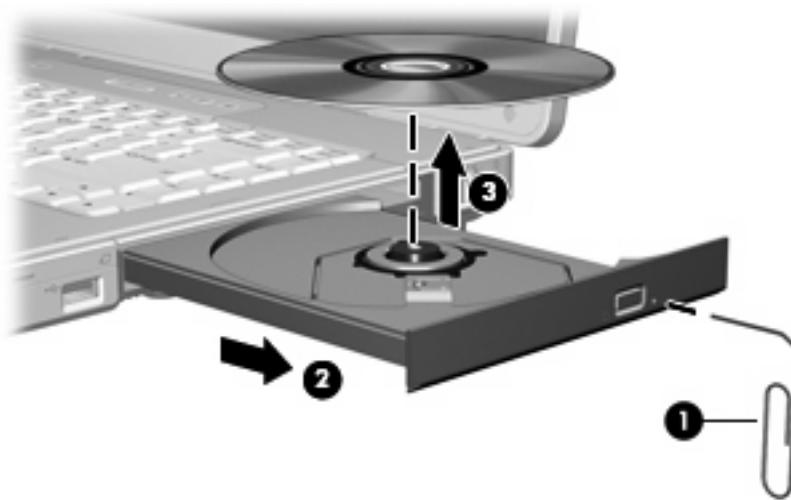

4. Close the media tray and place the disc in a protective case.

Using media activity hotkeys

Media activity hotkeys are combinations of the **fn** key **(1)** and 4 of the function keys. You can use these keys to control the play of an audio CD or a DVD that is inserted in the optical drive.



NOTE To control the play of an inserted video CD, use the media activity controls in your video CD player application.

- To play, pause, or resume an inserted audio CD or a DVD, press **fn+f9 (2)**.
- To stop an inserted audio CD or a DVD that is playing, press **fn+f10 (3)**.
- To play the previous track of an audio CD or the previous chapter of a DVD that is playing, press **fn+f11 (4)**.
- To play the next track of an audio CD or the next chapter of a DVD that is playing, press **fn+f12 (5)**.



Using the audio features

The following illustration and table describe the audio features of the computer.



Component	Description
(1) Volume down button	Decreases computer sound.
(2) Volume up button	Increases computer sound.
(3) Volume mute button	Turns off computer sound.
(4) Audio-in (microphone) jack	Connects an optional computer headset or microphone.
(5) Audio-out (headphone) jack	Connects optional powered stereo speakers, headphones, ear buds, headset, or television audio.
(6) Speakers (2)	Produce computer sound.

Using the audio-in (microphone) jack

The computer is equipped with a microphone jack that supports an optional monaural (single sound channel) microphone. Select models support a stereo (dual sound channel) microphone.



NOTE When connecting a microphone to the microphone jack, use a microphone with a 3.5-mm plug.

Using the audio-out (headphone) jack



WARNING! To reduce the risk of personal injury, adjust the volume before putting on headphones, earbuds, or a headset.

In addition to connecting headphones, the headphone jack is used to connect the audio function of an audio/video device such as a television or VCR.

When connecting a device to the headphone jack use only a 3.5-mm stereo plug.



NOTE When a device is connected to the headphone jack, the internal speakers are disabled.

Adjusting the volume

You can adjust the volume using the following controls:

- Computer volume buttons:
 - To mute or restore volume, press the volume mute button.
 - To decrease the volume, press the volume down button.
 - To increase the volume, press the volume up button.



NOTE The tapping sound made by the volume button is enabled at the factory. You can disable the sound in the Setup Utility (f10).

- Windows volume control:
 - a. Click the **Volume** icon in the notification area, at the far right of the taskbar.
 - b. Increase or decrease the volume by moving the slider up or down. Click the **Mute** icon to mute the volume.

– or –

 - a. Right-click the **Volume** icon in the notification area, and then click **Open Volume Mixer**.
 - b. In the Device column, increase or decrease the volume by moving the slider up or down. You can also mute the volume by clicking the **Mute** icon.

If the Volume icon is not displayed in the notification area, follow the steps below to place it there:

- a. Right-click in the notification area, and then click **Properties**.
- b. Click the **Notification Area** tab.
- c. Under System icons, select the **Volume** check box.
- d. Click **OK**.

Volume can also be adjusted within some applications.

Using the video features

The computer includes the following video features:

- S-Video-out jack that connects a range of video components that allow you to maximize your multimedia features
- External monitor port that connects a television, monitor, or projector to the computer

Using the external monitor port

The external monitor port connects an external display device to the computer.

To connect a display device to the computer:

- ▲ Connect the device cable to the external monitor port.



NOTE If a properly connected external display device does not display an image, press **fn+f4** to transfer the image to the device.

Using the S-Video-out jack

The 7-pin S-Video-out jack connects the computer to an optional S-Video device such as a television, VCR, camcorder, overhead projector, or video capture card.

The computer can support one S-Video device connected to the S-Video-out jack, while simultaneously supporting an image on the computer display or on any other supported external display.



NOTE To transmit video signals through the S-Video-out jack, you need an S-Video cable, available from most electronics retailers. If you are combining audio and video functions, such as playing a DVD movie on your computer and displaying it on your television, you also need a standard audio cable connected to the headphone jack, available from most electronics retailers.

To connect a video device to the S-Video-out jack:

1. Plug one end of the S-Video cable into the S-Video-out jack on the computer.

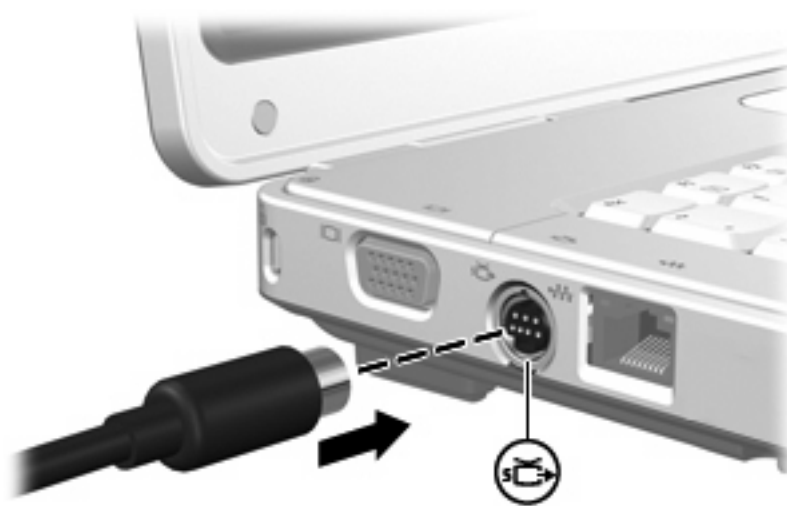

2. Connect the other end of the cable to the video device, as instructed in the documentation included with the device.
3. Press the **fn+f4** keys to switch the image between display devices connected to the computer.

Multimedia software

The computer includes preinstalled multimedia software. Some models may be shipped with additional multimedia software on an optical disc.

Depending on the hardware and software included with the computer, the following multimedia tasks may be supported:

- Playing digital media, including audio and video CDs, audio and video DVDs, and Internet radio
- Creating or copying data CDs
- Creating, editing, and burning audio CDs
- Creating, editing, and burning a video or movie to a DVD or video CD



NOTE For details about using software included with the computer, refer to the software user guides. These guides may be provided on CD or as online Help files within the specific application. User guides may also be found on the software manufacturer's Web site.

Identifying preinstalled multimedia software

To view and access the preinstalled multimedia software on the computer:

- ▲ Select **Start > All Programs**.



NOTE You can also reinstall multimedia software on the computer. Select **Start > All Programs > Software Setup**.

Installing multimedia software from a CD (select models only)

To install multimedia software from a CD included with the computer:

1. Insert the multimedia software CD into the optical drive.
2. When the installation wizard opens, follow the installation instructions on the screen.
3. Restart the computer if prompted.

Repeat the installation procedure for all multimedia software on CD that you want to install.

Using DVDPlay

DVDPlay, a software solution that has a simple and easy-to-use interface, allows you to watch DVD movies.

To open DVDPlay:

- ▲ Double-click the DVDPlay icon on the desktop.

– or –

Click **Start > All Programs > DVDPlay**.

For additional information, refer to the DVDPlay online Help.

Using multimedia software

To use the multimedia software installed on the computer:

1. Select **Start > All Programs**, and then open the multimedia application you want to use. For example, if you want to use Windows Media Player to play an audio CD, select **Windows Media Player**.



NOTE Some applications may be located in subfolders.

2. Insert the media disc, such as an audio CD, into the optical drive.
3. Follow the instructions on the screen.

– or –

1. Insert the media disc, such as an audio CD, into the optical drive.
An AutoPlay dialog box opens.
2. Click a multimedia task from the list of tasks.

Preventing playback disruptions

To reduce the possibility of playback disruption:

- Save your work and close all open applications before playing a CD or a DVD.
- Do not connect or disconnect hardware while playing a disc.

Do not initiate Hibernation or Sleep while playing a disc. Otherwise, you may see a warning message asking if you want to continue. If this message is displayed, click **No**. After you click No:

- Playback may resume.
– or –
- Playback may stop and the screen may clear. To return to playing the CD or DVD, press the power button and then restart the disc.

Protecting the CD or DVD write process



CAUTION To prevent loss of information and damage to a disc:

Before writing to a disc, connect the computer to a reliable external power source. Do not write to a disc while the computer is running on battery power.

Before writing to a disc, close all open applications except the disc software you are using.

Do not copy directly from a source disc to a destination disc or from a network drive to a destination disc. Instead, copy from a source disc or network drive to your hard drive, and then copy from your hard drive to the destination disc.

Do not use the computer keyboard or move the computer while the computer is writing to a disc. The write process is sensitive to vibration.

Changing DVD region settings

Most DVDs that contain copyrighted files also contain region codes. The region codes help protect copyrights internationally.

You can play a DVD containing a region code only if the region code on the DVD matches the region setting on your DVD drive.

If the region code on a DVD does not match the region setting on your drive, the following message is displayed when you insert the DVD: “Playback of content from this region is not permitted.” To play the DVD, you must change the region setting on your DVD drive. DVD region settings can be changed through the operating system or through some DVD players.



CAUTION The region settings on your DVD drive can be changed only 5 times.

The region setting you select the fifth time becomes the permanent region setting on the DVD drive.

The number of allowable region changes remaining on the drive is displayed in the **Changes remaining** field on the **DVD Region** tab. The number in the field includes the fifth and permanent change.

To change settings through the operating system:

1. Select **Start > Computer > System properties**.
2. In the left pane, click **Device Manager**.



NOTE Windows includes the User Account Control feature to improve the security of your computer. You may be prompted for your permission or password for tasks such as installing applications, running utilities, or changing Windows settings. Refer to Windows online Help for more information.

3. Click the “+” sign next to DVD/CD-ROM drives.
4. Right-click the DVD drive for which you want to change region settings, and then click **Properties**.
5. Make the desired changes on the **DVD Region** tab.
6. Click **OK**.

Observing the copyright warning

It is a criminal offense, under applicable copyright laws, to make unauthorized copies of copyright-protected material, including computer programs, films, broadcasts, and sound recordings. Do not use this computer for such purposes.

6 External Devices

Using a USB device

Universal Serial Bus (USB) is a hardware interface that can be used to connect an optional external device, such as a USB keyboard, mouse, drive, printer, scanner, or hub, to the computer. A hub provides additional USB ports for the system and can be connected to the computer or to another hub.

The computer has 2 standard USB ports on the left side of the computer. A third USB port on the right side of the computer is available on select models only. The USB ports on the computer support USB 2.0 and USB 1.1 devices.

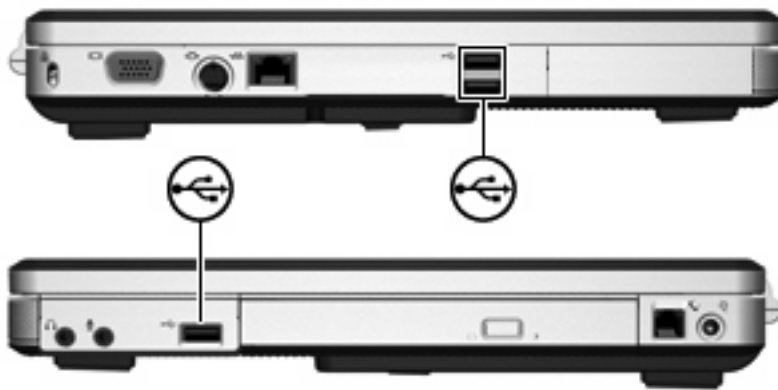

Connecting a USB device



CAUTION To prevent damage to the USB connectors, use minimal force to connect a USB device.

To connect a USB device to the computer, connect the USB cable of the device to the USB port. The operating system will issue a sound to indicate that a device has been connected.



NOTE The first time you connect a USB device, the "Installing device driver software" message is displayed in the notification area, at the far right of the taskbar.

Stopping a USB device



CAUTION To prevent loss of information or an unresponsive system, stop the USB device before removing it.

To stop a USB device:

1. Double-click the **Safely Remove Hardware** icon in the notification area, at the far right of the taskbar.
2. Click the USB device listing.



NOTE To display the Safely Remove Hardware icon, click **Show Hidden Icons** in the notification area.

3. Click **Stop**, and then click **OK**.

Required USB software

Some USB devices may require additional support software, which is usually included with the device. For more information about device-specific software, refer to the user guide for the device.

7 Memory Modules

Adding or replacing memory modules

The computer has one memory module compartment, which is located on the bottom of the computer. The memory capacity of the computer can be upgraded by adding a memory module to the vacant expansion memory module slot or by upgrading the existing memory module in the primary memory module slot.



WARNING! To reduce the risk of electric shock and damage to the equipment, unplug the power cord and remove all battery packs before installing a memory module.



CAUTION Electrostatic discharge (ESD) can damage electronic components. Before beginning any procedure, ensure that you are discharged of static electricity by touching a grounded metal object.

To add or replace a memory module:

1. Save your work and close all open programs.



NOTE If the computer is in the Sleep state or in Hibernation, you must first exit Sleep or Hibernation before shutdown is possible.

2. Click **Start**, click the arrow next to the Lock button, and then click **Shut Down**.
3. Close the display.
4. Disconnect all external devices connected to the computer.
5. Disconnect the power cord.
6. Turn the computer upside down.
7. Remove the battery pack from the computer.
8. Loosen the memory module compartment cover screw **(1)**.

9. Lift the memory module compartment cover (2) away from the computer.

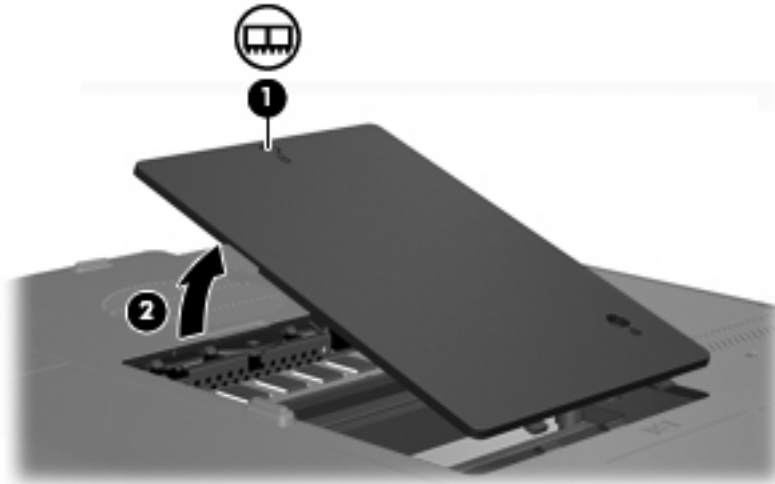

10. To remove a memory module:

- a. Pull away the retention clips (1) on each side of the memory module . (The memory module tilts up.)
- b. Grasp the edge of the memory module (2) and gently pull the module out of the memory module slot. (To protect a memory module after removal, place it in an electrostatic-safe container.)

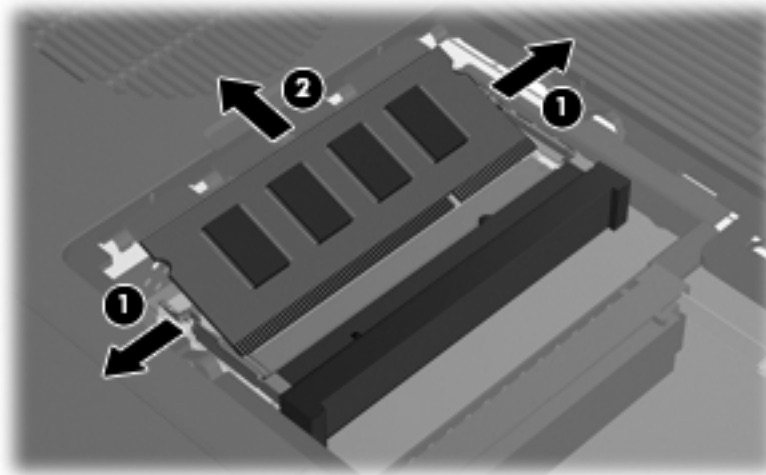

11. To insert a memory module:

- a. Align the notched edge (1) of the memory module with the tab in the memory module slot.
- b. With the memory module at a 45-degree angle from the surface of the memory module compartment, press the module (2) into the memory module slot until it is seated.

- c. Press the memory module (3) down until the retention clips snap into place.

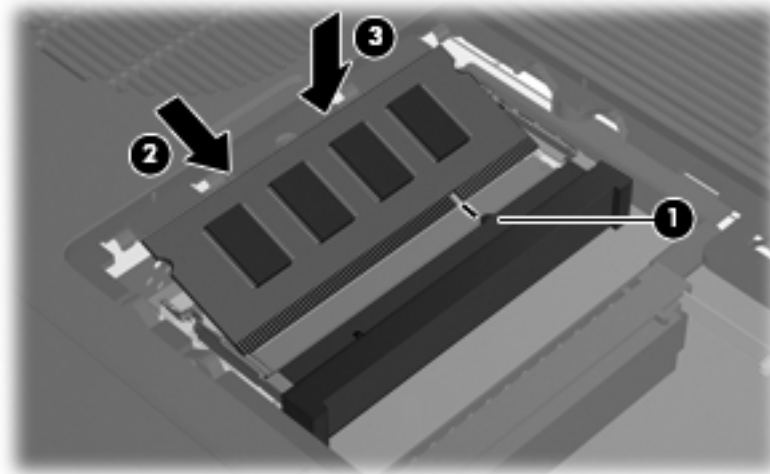

12. Align the tabs (1) on the memory module compartment cover with the notches on the computer.
13. Close the cover (2).
14. Tighten the memory module compartment cover screw (3).

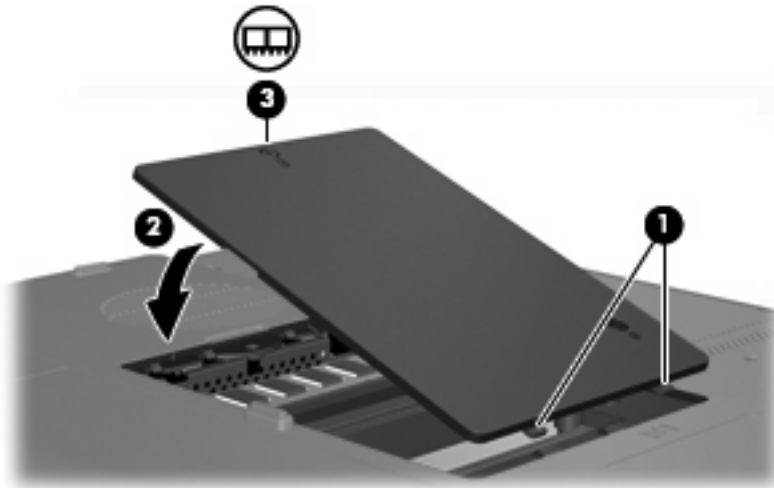

15. Replace the battery pack.
16. Reconnect external power and external devices.
17. Turn on the computer.

Index

- A**
 - AC adapter
 - identifying 12
 - AC adapter, connecting 34
 - altitude specifications 14
 - antennae 11
 - applications key, Windows 2
 - audio features 51
 - audio-in (microphone) jack 8, 51
 - audio-out (headphone) jack 8, 51
- B**
 - battery
 - calibrating 30
 - charging 29
 - conserving power 33
 - disposing 33
 - inserting 28
 - low battery levels 30
 - removing 28
 - storing 33
 - battery bay 10, 13
 - battery light, identifying 5
 - battery pack
 - identifying 12
 - battery pack release latch 10
 - battery power 27
 - bays
 - battery 10, 13
 - hard drive 10
 - buttons
 - display release 6
 - mute 4
 - power 4
 - TouchPad 3, 15
 - volume 4
 - volume down 51, 52
 - volume mute 51, 52
 - volume up 51, 52
 - wireless 4
- C**
 - cable
 - USB 59
 - calibrating battery 30
 - caps lock light 5
 - Certificate of Authenticity label 13
 - charging batteries 29
 - compartments, memory module 10
 - components
 - bottom 10
 - display 6
 - front 6
 - left-side 9
 - rear 7
 - right-side 8
 - top 2
 - connection, external power 34
 - connector, power 8
 - conservation, power 33
 - copyright warning 58
 - cord, power, identifying 12
 - critical battery level 30
- D**
 - display
 - image, switching 18, 20
 - screen brightness
 - hotkeys 18, 21
 - display release button 6
 - drives
 - caring for 36
 - IDE drive light 37
 - optical 8
 - See *also* hard drive, optical drive
 - drives. 37
 - See *also* hard drive; optical drive
 - DVD region settings 58
 - DVDPlay
 - using 55
- E**
 - environmental specifications 14
 - external monitor port 9, 53
- F**
 - fn key
 - hotkeys 17
 - identifying 2
 - function keys
 - hotkeys 17
 - identifying 2
- H**
 - hard drive
 - installing 39
 - removing 38
 - hard drive bay, identifying 10
 - headphone (audio-out) jack 8
 - Help and Support hotkey 18, 19
 - Hibernation
 - exiting 25
 - hotkey 18, 20
 - initiating 25
 - writing to CD or DVD 45
 - hotkeys
 - audio CD or DVD
 - controls 18, 21
 - decreasing screen brightness 18, 21
 - description 17
 - displaying system information 18
 - increasing screen brightness 18, 21
 - initiating Hibernation 18, 20
 - initiating QuickLock 18, 21

- media activity 50
- opening Help and Support 18, 19
- opening Print Options window 18, 19
- opening Web browser 18, 19
- quick reference 18
- switching screen image 18, 20
- using 18
- hubs 59
- humidity specifications 14

I
IDE drive light 5, 37

J
jacks

- audio-in (microphone) 8, 51
- audio-out (headphone) 8, 51
- RJ-11 (modem) 8
- RJ-45 (network) 9
- S-Video-out 9, 53, 54

K
keyboard

- hotkeys 17

keypad keys 2
keypad, embedded

- enabling and disabling 22
- identifying 22
- switching key functions 23
- using 22

keypad, external

- num lock mode 23
- using 23

keys

- esc 2
- fn 2
- function 2
- keypad 2
- Windows applications 2
- Windows logo 2

L
labels

- Microsoft Certificate of Authenticity 13
- modem approval 13
- regulatory 13

- service tag 13
- wireless certification 13
- WLAN 13

latches

- battery pack release 10

lights

- battery 5
- caps lock 5
- IDE drive 5, 37
- mute 5
- num lock 5
- power 5
- wireless 5

LightScribe 41
lock, security cable 9
low battery level 30

M
media activity hotkeys 50
media controls, hotkeys 18, 21
memory

- adding or replacing memory modules 61

memory module compartment 10
memory module compartment cover

- removing 62
- replacing 63

memory modules

- adding 61
- replacing 61

microphone (audio-in) jack 8
microphones, supported 51
Microsoft Certificate of Authenticity label 13
modem approval label 13
monitor port, external 9
mouse, external

- setting preferences 16
- using 16

multimedia software

- described 55
- identifying 55
- installing 55
- using 56

mute button 4, 51, 52
mute light 5

N
network (RJ-45) jack 9

- num lock light 5
- num lock mode, external keypad 23

O
operating environment specifications 14
operating system

- Microsoft Certificate of Authenticity label 13
- Product Key 13

optical disc

- inserting 42, 47
- removing, with power 43, 48
- removing, without power 44, 49

optical drive

- identifying 8, 46
- supported types 41

P
pointing devices.. See TouchPad
ports

- external monitor 9, 53
- USB 8, 9, 59

power

- connecting 34
- conserving 33

power button 4
power connector 8
power cord 12
power light 5
Print Options window hotkey 18, 19
Product Key 13
product name and number, computer 13

Q
QuickLock hotkey 18, 21

R
rated input power specifications 14
regulatory information

- modem approval label 13
- regulatory label 13
- wireless certification labels 13

release button display 6

- release latch
 - battery pack 10
- RJ-11 (modem) jack 8
- RJ-45 (network) jack 9
- S**
- S-Video 20
- S-Video-out jack 9, 53, 54
- screen brightness hotkeys 18, 21
- screen image, switching 18, 20
- scroll zones, TouchPad 3, 15
- security cable slot 9
- serial number, computer 13
- service tag 13
- shutdown 35
- shutting down 35
- Sleep
 - exiting 24
 - initiating 24
 - writing to CD or DVD 45
- slots
 - memory module 10
 - security cable 9
- software
 - multimedia 55
 - USB devices 60
- speakers 6, 51
- specifications
 - operating environment 14
 - rated input power 14
- storing battery 33
- system information
 - hotkey 18
- system information hotkey 18
- T**
- temperature specifications 14
- TouchPad
 - identifying 15
 - setting preferences 16
 - using 16
- TouchPad buttons 3, 15
- TouchPad scroll zones 3, 15
- traveling with the computer
 - environmental
 - specifications 14
 - modem approval label 13
 - wireless certification labels 13

- U**
- USB cable, connecting 59
- USB devices
 - connecting 59
 - description 59
 - required software 60
 - stopping 60
- USB hubs 59
- USB ports, identifying 8, 9, 59

- V**
- vents 7, 10
- video features 53
- video transmission types 20
- volume buttons 4
- volume down button 51, 52
- volume mute button 51, 52
- volume up button 51, 52
- volume, adjusting 52

- W**
- Web browser hotkey 18, 19
- Windows applications key 2
- Windows logo key 2
- wireless antennae 11
- wireless button 4
- wireless certification label 13
- wireless light 5
- WLAN label 13

