

ROBERTS

Sound for Generations

R9929

PLL Digital 3 band radio with
station name display



Please read this manual before use

Contents

<i>Important Information</i>	1	<i>Operating your radio using RDS</i>	16
<i>Automatic plug and play setup</i>	2	<i>Display modes</i>	16
<i>Controls</i>	3-4	<i>Alternate frequency (AF)</i>	16
<i>Display</i>	5	<i>Radio text</i>	17
<i>Battery Operation</i>	6	<i>Programme type display (PTY)</i>	17
<i>Mains Operation</i>	6	<i>Programme type search</i>	18
<i>Setting the clock automatically</i>	7	<i>Traffic announcements (TA)</i>	18-19
<i>Setting the clock manually</i>	8	<i>Display backlight</i>	20
<i>Setting the day of week manually</i>	8	<i>Demonstration mode</i>	20
<i>Setting the alarm time</i>	9	<i>Headphones</i>	20
<i>Displaying the alarm time</i>	9	<i>Troubleshooting</i>	21
<i>Wake to buzzer</i>	9	<i>General</i>	21
<i>Wake to radio</i>	10	<i>Specifications</i>	22
<i>Snooze control</i>	10	<i>Circuit features</i>	22
<i>Sleep timer</i>	10		
<i>Weekend alarm cancel</i>	11		
<i>Operating your radio - search tuning</i>	11		
<i>Operating your radio - manual tuning</i>	12		
<i>Presetting stations</i>	13		
<i>Recalling a preset station</i>	14		
<i>Last station memory</i>	14		
<i>RDS features</i>	15		



Important Information - please read before use

To assist the auto setup of your radio it is recommended that, before connecting your radio to a power supply (batteries or mains), to fully extend the telescopic aerial and place your radio in a position where radio reception is best.

note : the two LR6 (AA size) batteries provide power for the clock/memory backup and must be fitted at all times.

Automatic Plug and Play setup

When your radio is first connected to a power supply (batteries or mains) or after a power failure (when backup batteries are not installed), the Auto setup will proceed as follows:-

- Automatically search all wavebands and store stations in presets.
 - Automatically set the time and day of week.
1. Install batteries or connect to mains (see page 6). Your radio will show "SEARCHING FM PLEASE WAIT" followed by a Demonstration of the RDS features available.
 2. Your radio is ready for use when the **Auto Time indicator**  stops flashing.
 3. The auto time indicator  will flash in the display whilst time setting is carried out.
 4. If the first station detected by the automatic setup does not carry Clock Time information your radio will automatically change to another station after 1-2 minutes. This process will repeat until the clock is set.
 5. Press the **Power button** to switch on your radio and press one of the **Preset buttons** to select a station. Adjust the volume using the **Volume control**. To switch off your radio press the **Power button**.
Note:- Auto setup can take up to 5 minutes to complete and is dependent on the signal strength and number of stations in your area.
To interrupt the Auto setup press and release the **Memo button**.
Should Auto setup fail, setting the clock and pre-setting stations can be carried out manually as described in the following sections.

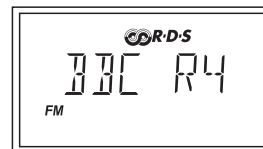
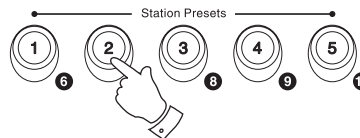
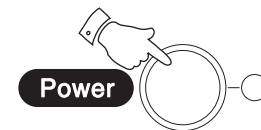
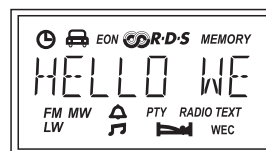
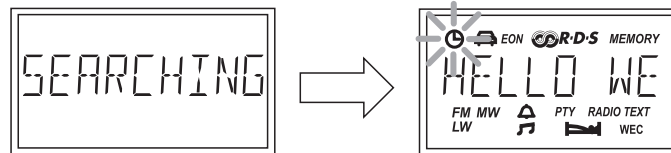
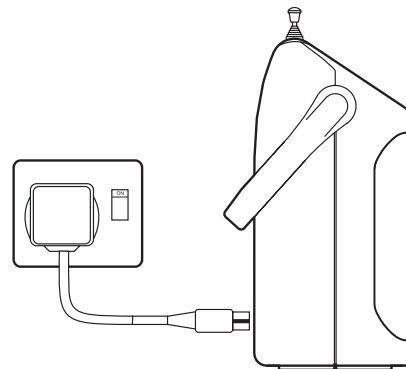

If you need any further advice, please call our Technical Helpline on :-
020 8758 0338 (Mon-Fri)

Controls

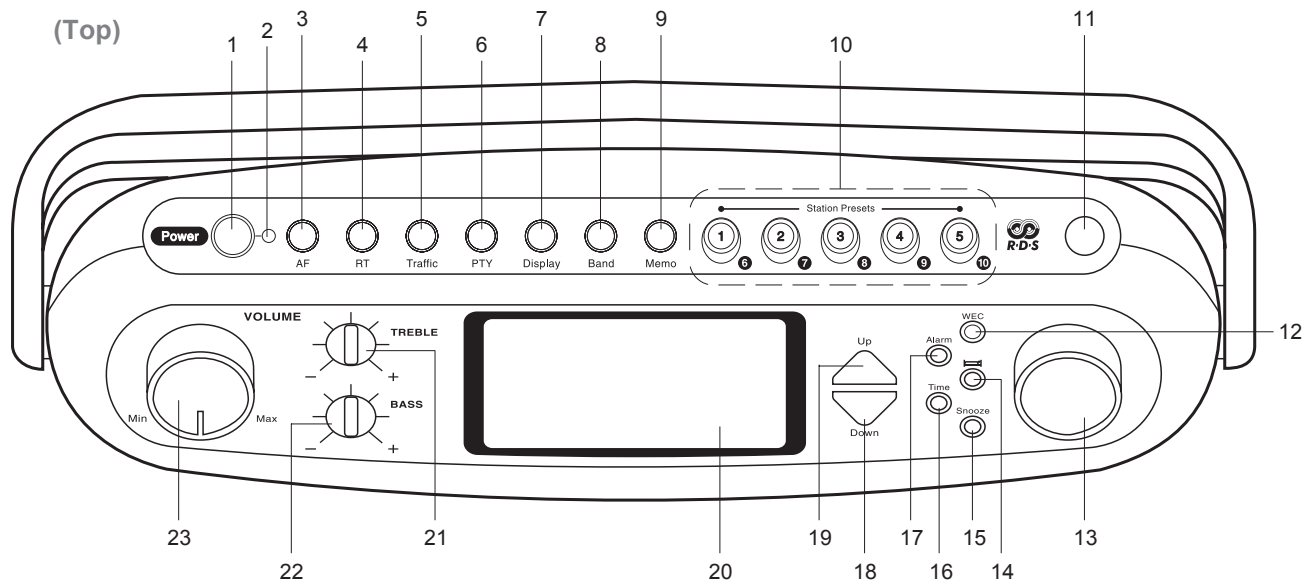

1. Power button
2. Mains LED indicator
3. Alternate frequency button
4. Radio text button
5. Traffic button
6. Program type button

7. Display button
8. Band button
9. Memo button
10. Preset buttons
11. Telescopic aerial
12. Weekend cancel button

13. Tuning control
14. Sleep button
15. Snooze button
16. Time button
17. Alarm button
18. Tuning down button

19. Tuning up button
20. Liquid crystal display (LCD)
21. Treble control
22. Bass control
23. Volume control

Controls

(Rear)

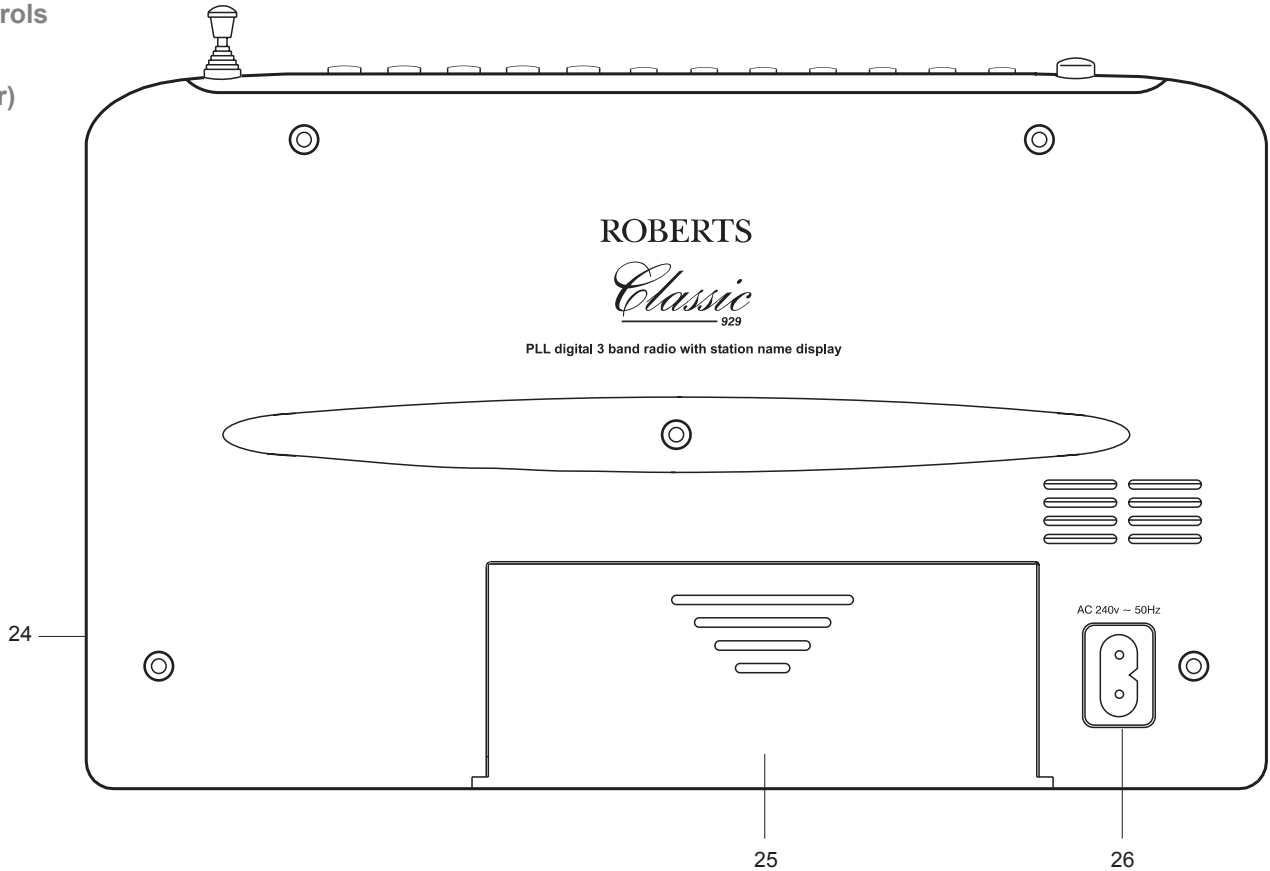

- 24. Headphone socket (on side)
- 25. Battery compartment

- 26. Mains socket

If you need any further advice, please call our Technical Helpline on :-
020 8758 0338 (Mon-Fri)

Display

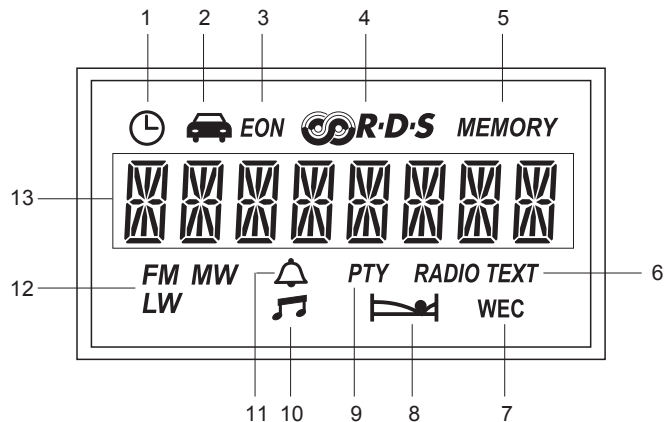

- | | |
|--------------------------------------|---|
| 1. Auto time indicator | 8. Sleep time indicator |
| 2. Traffic information indicator | 9. Programme type indicator |
| 3. Enhanced other networks indicator | 10. Radio alarm indicator |
| 4. RDS indicator | 11. Buzzer alarm indicator |
| 5. Memory indicator | 12. Waveband indicator |
| 6. Radio text indicator | 13. Frequency, time and text display area |
| 7. Weekend cancel indicator | |

Battery operation

1. Remove the **Battery cover** on the rear of the unit by pushing the battery door in and downwards.
2. Insert two LR6 (AA size) batteries into the small spaces under flap with yellow label. Insert four LR14 (C size) batteries into the remaining spaces in the compartment. Take care to ensure all batteries are inserted with the correct polarity as shown inside the battery compartment. Replace the battery cover.

note : the two LR6 (AA size) batteries provide power for the clock/memory backup and must be fitted at all times.

3. Reduced power, distortion and a 'stuttering' sound are all signs that the batteries may need replacing.
4. If the radio is not to be used for any extended period of time it is recommended that the batteries are removed from the radio.

We would recommend for economy that the R9929 is used on the mains whenever possible with battery operation for occasional or stand-by use only.

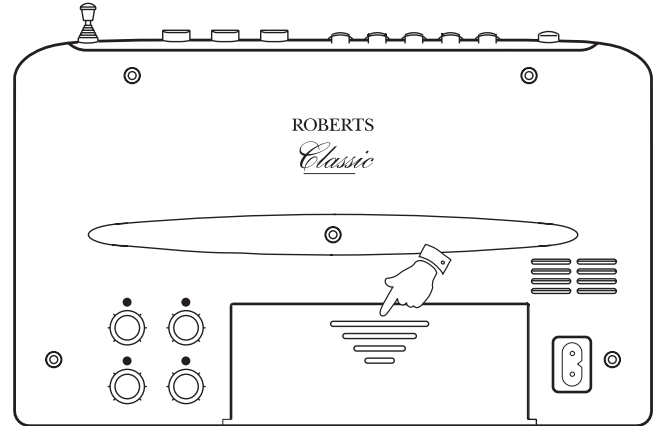

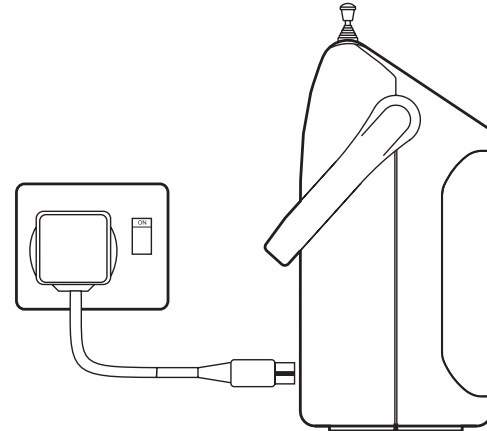

Mains operation

1. Place your radio on a flat surface.
2. Plug the mains lead into the **Socket** located on the rear of your radio ensuring that the plug is pushed fully into the socket.
3. Plug the other end of the mains lead into a wall socket and switch on the wall socket.



Setting the clock automatically

The clock time and day of week can be set automatically when receiving an RDS station that transmits clock time (CT). The CT information is transmitted once every minute. If the station has sufficient signal strength the clock will set within one or two minutes.

1. Switch on the radio with the **Power button**.
2. Select the FM waveband using the **Band button**.
3. Fully extend the **Telescopic aerial**.
5. Repeatedly press the **Time button** until the auto time symbol  appears in the display.
6. Press and hold down the **Up or Down buttons** until the frequency in the display begins to change rapidly, release the button.
7. The radio will now start to search the FM waveband and will stop when it finds a station of sufficient strength. If the station is of sufficient strength the **RDS** symbol will light up in the liquid crystal display.
8. The auto time indicator  will flash in the liquid crystal display indicating that the radio is waiting for the RDS time signal. The  indicator will stop flashing when the time is set.

If the clock does not set within three to four minutes, the radio station may not be transmitting clock time (CT) information - try another radio station. eg. BBC R1, R2, R3 or R4.

The clock time and day of week are updated each time the radio is switched on and whilst listening to an RDS station transmitting clock time (CT) information.

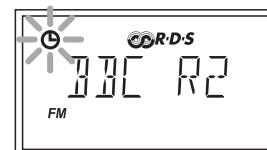
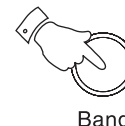
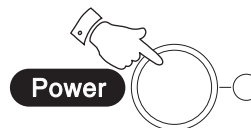

Setting the clock manually

1. Ensure that the radio is switched off.
2. Repeatedly press the **Time button** until the auto time symbol  is removed from the display.
3. Press and hold down the **Time button**.
4. Whilst the **Time button** is held down set the time by rotating the **Tuning control** or by pressing the **Up or Down buttons**. The clock uses the 24 hour system e.g. 2:30pm is shown as 14:30
5. Release the **Time button** when clock setting is complete.

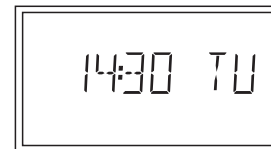
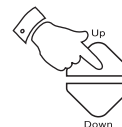
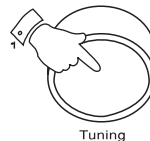

Setting the day of week manually

1. Ensure that the radio is switched off.
2. Press and hold down the **Snooze button**.
3. Whilst the **Snooze button** is held down set the day of week by rotating the **Tuning control** or by pressing the **Up or Down buttons**
4. Release the **Snooze button** when day of week setting is complete.

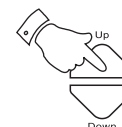
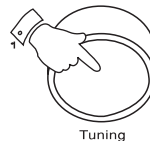

Setting the alarm time

1. Press and hold down the **Alarm button**.
2. Whilst the **Alarm button** is held down set the alarm time by rotating the **Tuning control** or by pressing the **Up or Down buttons**. The clock uses the 24 hour system e.g. 2:30pm is shown as 14:30. At this stage disregard symbols.
3. Release the **Alarm button** when alarm setting is complete.

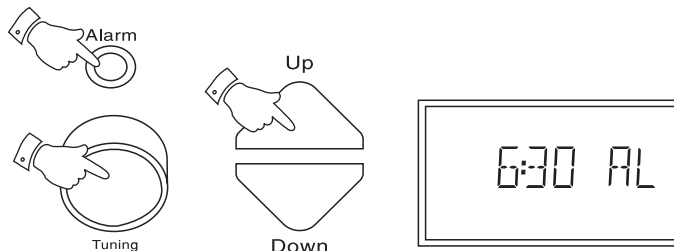

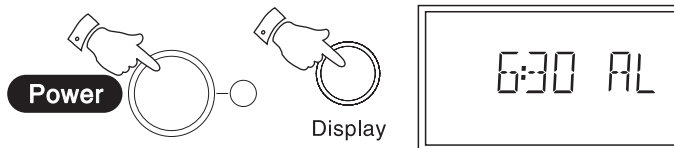

Displaying the alarm time

1. Ensure that the radio is switched off.
2. Press the **Display button** once to display alarm time. Clock time will resume automatically after 3 seconds.



Wake to buzzer

1. Set the alarm time as previously described.
2. Switch off your radio using the **Power Button**. Repeatedly press and release the **Alarm button** until the  symbol appears in the display.
3. At the preselected time the buzzer will turn on. The buzzer will switch off automatically after 90 minutes. The buzzer alarm may be turned off for 24 hours by pressing the **Power button**.
4. To permanently cancel the buzzer alarm repeatedly press and release the **Alarm button** until the  and  symbols are removed from the display.



Wake to radio

1. Set the alarm time as previously described. Tune to the required station and set the **Volume control** to the level at which you wish to wake.
3. Switch off your radio using the **Power Button**. Repeatedly press and release the **Alarm button** until the 🎵 symbol appears in the display.
4. At the preselected time the radio will turn on. The radio will switch off automatically after 90 minutes. The radio alarm may be turned off for 24 hours by pressing the **Power button**.
5. To permanently cancel the radio alarm repeatedly press and release the **Alarm button** until the 🎵 and 🔔 symbols are removed from the display.



Snooze control

1. The radio or buzzer alarm can be silenced for 5 minutes by pressing the **Snooze button**. This sequence can be repeated during the 90 minutes alarm period.



Sleep timer

Your radio can be set to turn off after a preset time has elapsed.

1. Press and hold down the **Sleep button** until the desired time is reached (maximum 90 minutes in 10 minute steps). The radio will switch off after the sleep time has elapsed.
2. To cancel the sleep function before the preset time has expired, press the **Power button**.

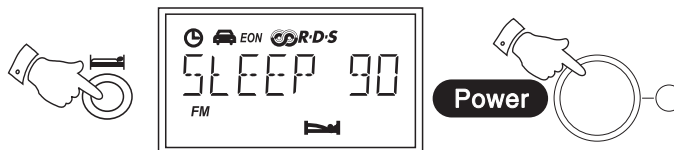

If you need any further advice, please call our Technical Helpline on :-
020 8758 0338 (Mon-Fri)

Weekend alarm cancel

If you do not wish to be woken by the preset alarm at weekends proceed as follows:-

1. Repeatedly press and release the **Weekend cancel button** until the **WEC** symbol appears in the display. The alarm will now only sound on weekdays.
2. Press the **Weekend cancel button** to switch off this function. The **WEC** symbol will be removed from the display



Operating your radio - search tuning

1. Switch on your radio by pressing the **Power button**.
2. Select the required waveband by pressing the **Band button**. The waveband selected will appear in the display. On FM fully extend the **Telescopic aerial**. On MW and LW rotate your radio for best reception.
3. Press and hold down either the **Tuning Up or Down buttons** until the frequency in the display begins to change rapidly. Release the button.
4. Your radio will scan the selected waveband, stopping each time it finds a station of sufficient strength. Adjust the **Volume control**, **Bass and Treble controls** to the required settings.
5. To search for additional stations repeat the above procedure. Search tuning may be stopped by a single press on either the **Tuning Up or Down buttons**.
6. Press the **Power button** to turn off your radio.

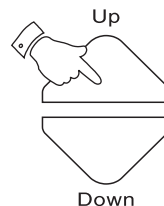
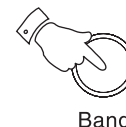
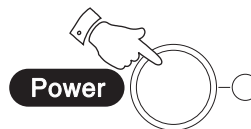

Operating your radio - manual tuning

1. Switch on your radio by pressing the **Power button**.
2. Select the required waveband by pressing the **Band button**. The waveband selected will appear in the display. On FM fully extend the **Telescopic aerial**. On MW and LW rotate your radio for best reception.
3. Rotate the Tuning control to select the required frequency. The frequency steps are:- FM 50kHz, MW 9kHz and LW 1kHz. Adjust the **Volume control**, **Bass and Treble controls** to the required settings.
4. Press the **Power button** to turn off your radio.

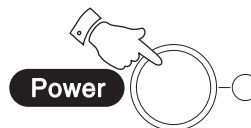
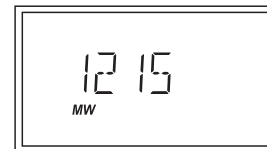
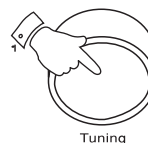
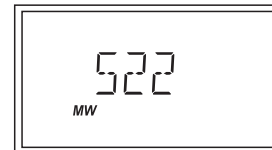
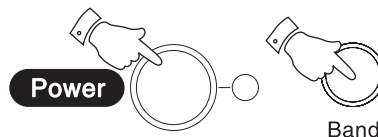

Pre-setting stations

You may store up to 10 different stations on each of the three wavebands giving a total of 30 preset stations.

1. Switch on your radio using the **Power button**.
2. Select the desired waveband using the **Band button**.
3. Tune into the required station using one of the tuning methods previously described.
4. Press and release the **Memo button**, the word 'Memory' will flash in the display.
5. Whilst 'Memory' is flashing press one of the **Preset buttons** under which you wish to store the station. Presets 6 to 10 are obtained by pressing the **Preset button** twice.
6. Press the **Memo button** to store the station. The preset number will now appear under 'Memory' in the display.
7. Repeat the above procedure for the remaining presets
8. Press the **Power button** to turn off your radio.

Note: Pre-setting of stations can only be carried out whilst 'Memory' is flashing in the display (5 seconds).

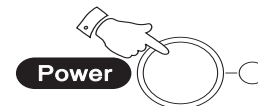
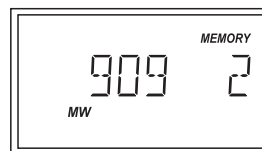
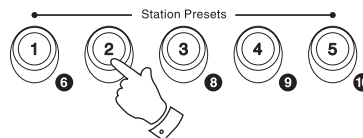
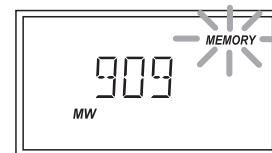
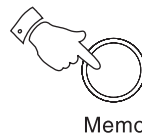
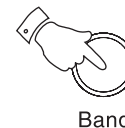
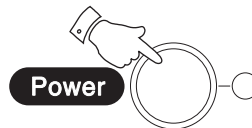

Recalling a preset station

1. Switch on your radio using the **Power button**.
2. Select the desired waveband using the **Band button**.
3. Press one of the **Preset buttons** to recall the station. Presets 6 to 10 are obtained by pressing the **Preset button** twice.

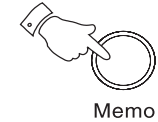
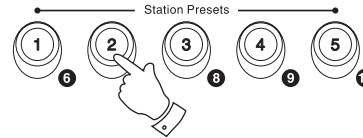
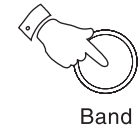
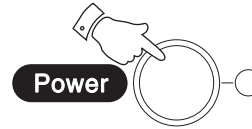

Last station memory

1. Your radio provides an automatic last station memory function. This function recalls the station that was playing when the radio was switched off.

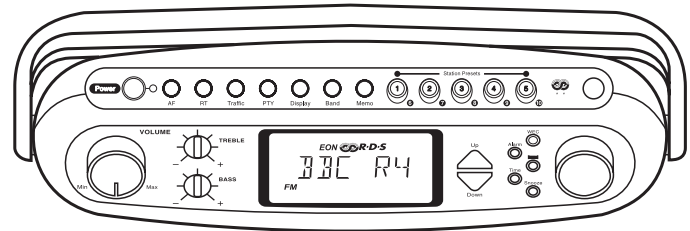

Radio Data System (*RDS*)

The **Radio Data System** (*RDS*) is a system in which inaudible digital information is transmitted in addition to the normal FM radio programme. *RDS* offers several useful features, the following are available on your radio:-

Programme Identification (PI)

This information consists of a code, which is assigned to each individual radio programme to enable it to be distinguished from all others. It is not intended for direct display or access by the user but used internally by the microprocessor.

Programme Service (PS) name

The **Programme Service** name is a text usually consisting of not more than eight alphanumeric characters. It indicates information about the programme being broadcast. A station name or an abbreviation is shown in the display instead of the tuned frequency (Example: *BBC R4*).

Traffic Information System

The **Traffic Programme** identification (**TP**) indicates which *RDS* stations provide Traffic information. The **Traffic Announcement** identification (**TA**) indicates Traffic information is being broadcast. When **TA** is received, the  symbol will flash and the volume increases slightly.

Enhanced Other Network (EON)

Additional information about other programmes within the same network is transmitted when your broadcasting station is using an **Enhanced Other Network**. The *EON* indicator will be displayed and you will hear traffic flashes of other programmes within the network automatically (if the **Traffic Announcement / EON** function is switched on).

Clock Time (CT) automatic adjustment

The **Clock Time** information transmitted from the broadcasting station can be used for setting and synchronising the clock of your radio automatically. The Auto-Time function can be enabled or disabled by the user.

Alternative Frequencies (AF)

This feature provides a list of **Alternative Frequencies** for the station being received. You can switch to those frequencies directly if desired.

Programme Type (PTY)

This is an identification number transmitted with each programme to specify the type of the programme being broadcast e.g. *NEWS*, *ROCK*, *CLASSIC* etc. The **PTY** number can be used so that search tuning responds only to the selected programme type.

Radio Text (RT)

Radio Text is a text message of up to 64 characters in length. It is displayed by scrolling the characters of the message from right to left.

Note: *RDS* features are available on the **FM** band only.

Operating your radio using RDS (Radio data system)

1. Switch on your radio and select the FM waveband.
2. Tune into a station, the display will indicate frequency for two seconds and then change to show the station name. The  **RDS** symbol will appear in the display
3. If the station does not carry RDS information only the station frequency will be shown.

Note: the  **RDS** indicator will flash if the signal is too weak for RDS operation.

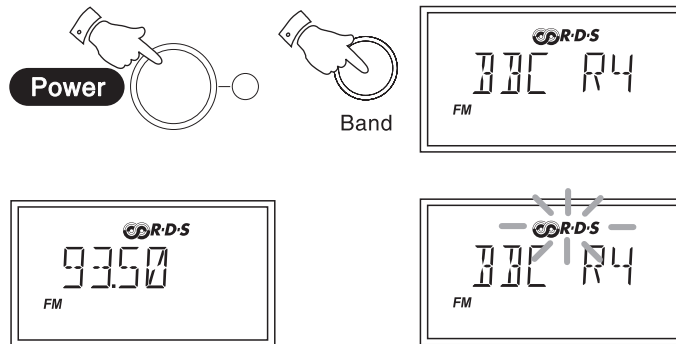

Display Modes

1. Whilst tuned to an RDS station you can change between station name and normal time display by pressing the **Display button**.



Alternate Frequency (AF)

The RDS system provides a list of alternative frequencies for the station you are tuned to.

1. Switch on your radio and select the FM waveband. Tune into a station carrying RDS information.
2. Press the **AF button**, your radio will scan the list of alternate frequencies and select the one giving best reception. If AF information has not yet been received or is not provided by the station you are listening to, the radio will remain at the current frequency and the display will indicate 'NO AF'

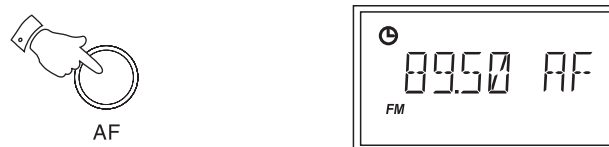

Radio Text (RT)

The RDS system provides a text message of up to 64 characters in length. It is displayed by scrolling the characters of the message from right to left.



1. Switch on your radio and select the FM waveband. Tune into a station carrying RDS information.
2. Press the **RT button**, the **Radio Text** symbol will appear in the display.
3. If the station provides **Radio Text**, the message will scroll from right to left in the display.
4. To speed up the scrolling of **Radio Text** press and hold down the **RT button**.
5. If radio text is not available the display will show **'NO TEXT'**
6. Press the **RT button** to switch off the **Radio Text** display.

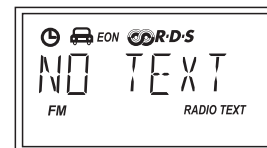
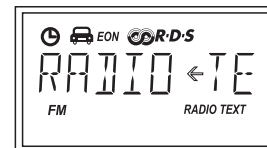

Programme type display (PTY)

The RDS system provides display of programme type e.g. *NEWS*, *ROCK*, *POP* etc.



1. Switch on your radio and select the FM waveband. Tune into a station carrying RDS information.
2. To display the programme type of the current station press the **PTY button**, the programme type will appear in the display. The display will return to showing station name after approximately 5 seconds.

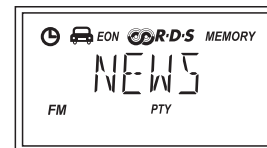

Programme Type search (PTY)

1. To search for a station of a particular type, repeatedly press and release the PTY button until the required programme type is shown in the display. Press and release either the **Up or Down buttons**.
2. Your radio will now search for a station of the selected type. When a station of the required type is found the search will stop and the station will play. The **PTY** indicator will flash during programme type search.
3. Programme type search may be stopped by pressing either the **Up or Down buttons**.

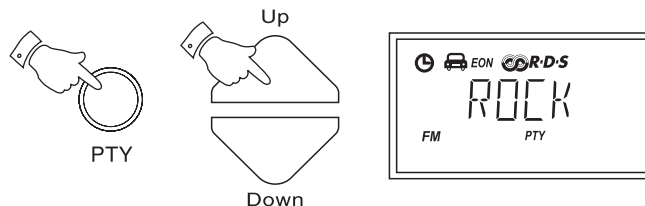

Traffic Announcements (TA)

1. Switch on the radio select the FM waveband and tune to an RDS station. The **RDS** symbol will appear in the display.
2. Press the **Traffic button** once. If the station provides traffic information the **car** symbol will appear in the display.
3. If the station does not provide traffic information the **car** symbol will not appear and the radio will beep indicating that no traffic information is available.
4. During traffic announcements the **car** symbol will flash in the display and the volume will increase slightly.

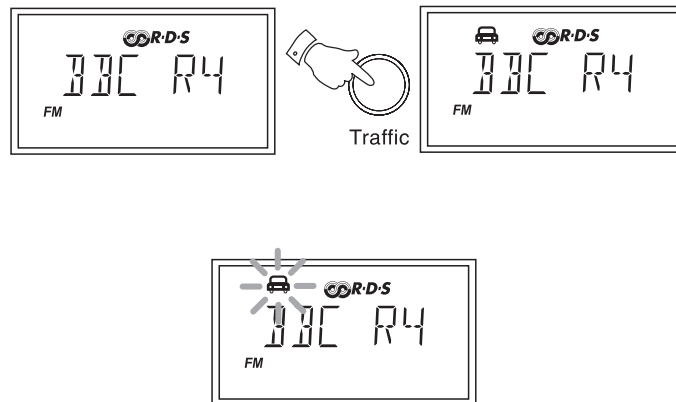

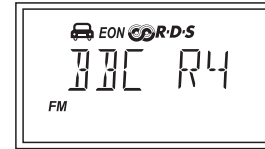

- If the station carries Enhanced Other Network information the **EON** symbol will appear in the display. The radio will automatically tune to other stations transmitting traffic information. When the traffic announcement has finished the radio will re-tune to the previously selected station.

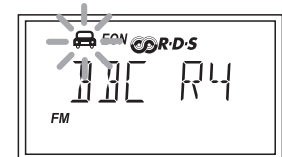
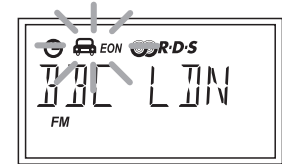
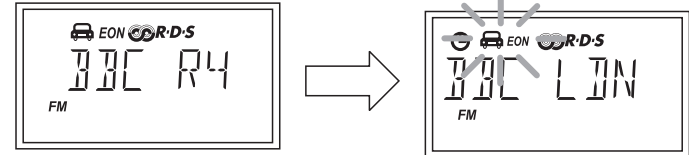

e.g. If the radio is tuned to a national station such as BBC Radio 4, it will automatically re-tune to any BBC local station broadcasting traffic announcements. When the traffic announcement on the local station is finished the radio will re-tune to the previously selected station.

Note: There may be occasions when the station to which you are listening tells the radio to re-tune to a traffic announcement on a local station that is not receivable at your location. Under these circumstances there will be some hiss before the radio re-tunes back to the previously selected station.



- To turn off traffic information press the traffic button, the  symbol will be removed from the display.



Display backlight

1. The display backlight will be switched on for 8 seconds whenever a button is pressed. During Automatic Set Up, Demonstration and Radio Text modes the display backlight will remain on.

Demonstration mode

Your radio is equipped with a demonstration mode which when active highlights the main features available on your radio.

1. Press and hold down the **Display button** until the display enters Demonstration mode.
2. Press any key to cancel demonstration mode.

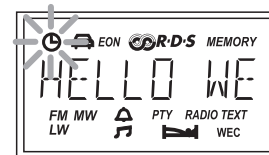
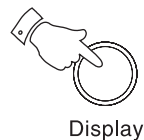

Headphones

1. A **Headphone Socket** (3.5mm) located on the right hand end of your radio is provided for use with either headphones or an earpiece. Inserting the headphone plug automatically mutes the internal loudspeaker.

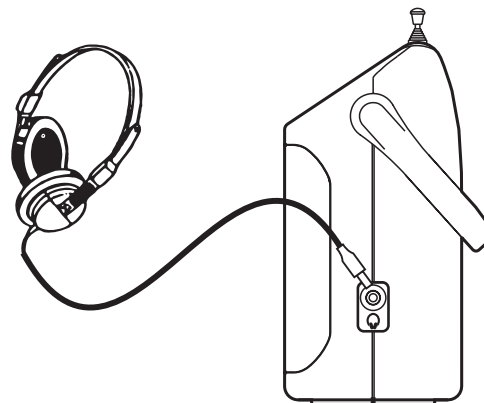

Troubleshooting

Due to external interference (caused by static charges from carpets, thunderstorms, etc.), the control electronics of your radio could receive bad information. If the display is incomplete or the radio is not responding to control buttons, proceed as follows:-

Remove the power supply (the mains and all batteries) and re-install them again after one minute.

This resets the radio to its initial state. The stored data for the individual memory positions, the clock, the alarm settings and the Last Station Memory are all cleared.

General

Do not allow this radio to be exposed to water, steam or sand. Do not leave your radio where excessive heat could cause damage such as in a parked car where the heat from the sun can build up even though the outside temperature may not seem too high. It is recommended that the FM band be used wherever possible as better results in terms of quality and freedom from interference will usually be obtained than on the MW or LW bands.



Specifications

Power Requirements

Mains	AC 230 volts, 50Hz  only
Batteries	4 x LR14 (C size) for radio 2 x LR6 (AA size) for clock/memory

Battery Life

Approx. 40hrs of listening for 4 hours a day at normal volume using alkaline cells.

Frequency Coverage

FM	87.5-108MHz
MW	522- 1620kHz
LW	144- 281kHz

Circuit Features

Loudspeaker	92mm 4ohms
Output Power	1W into 4ohms
Headphone socket	3.5mm dia
Aerial System	FM Telescopic aerial MW Built-in Ferrite aerial LW Built-in Ferrite aerial

ROBERTS RADIO LIMITED

PO BOX 130
MEXBOROUGH
SOUTH YORKSHIRE
S64 8YT

The Company reserves the right to amend the specification without notice.

Guarantee

This instrument is guaranteed for twelve months from the date of delivery to the original owner against failure due to faulty workmanship or component breakdown, subject to the procedure stated below. Should any component or part fail during this guarantee period it will be repaired or replaced free of charge.

The guarantee does not cover:

1. Damage resulting from incorrect use.
2. Consequential damage.
3. Receivers with removed or defaced serial numbers.

N.B. Damaged or broken telescopic aerials will not be replaced under guarantee.

Procedure:

Any claim under this guarantee should be made through the dealer from whom the instrument was purchased. It is likely that your Roberts' dealer will be able to attend to any defect quickly and efficiently, but should it be necessary the dealer will return the instrument to the company's service department for attention. In the event that it is not possible to return the instrument to the Roberts' dealer from whom it was purchased, please contact Roberts Radio Technical Services at the address shown below.

These statements do not affect the statutory rights of a consumer.

ROBERTS RADIO TECHNICAL SERVICES DEPARTMENT

97-99 Worton Road
Isleworth Middlesex
TW7 6EG

Technical Helpline:- 020 8758 0338 (*Mon-Fri*)

