

# MOLON

officine meccaniche macchine agricole  
[www.molonmachinery.com](http://www.molonmachinery.com)

MOLON GIOVANNI s.n.c  
di MOLON ENIO e BRUNO  
VIA MESTRINA 10 - ARLESEGA  
35035 MESTRINO - PD - ITALY  
Tel. +39-499000103 - Fax +39-499000694  
e-mail: [info@molonmachinery.com](mailto:info@molonmachinery.com)

## USE AND MAINTENANCE MANUAL

Machine: HAY RAKE MINOR MINI 120

Model: **M002** **MINOR MINI 120**

Serial no.: 13753

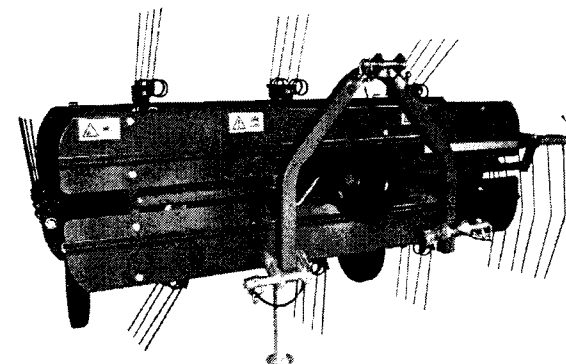

Dealer:

Delivery date:

Owner or user:

N.B: This part of the manual must be filled in at the time of delivery or installation; it is important to refer the above mentioned numbers in any communication with your dealer.

## INTRODUCTION

### Guide to the consultation

Congratulations on your purchase of a MOLON machine. This machine has been developed by engineers with years of experience on the field and it is built to the highest MOLON quality standards. This manual will help you to know better and to appreciate the features of your machine and it is considered integral part of the machine itself.

This machine can be relied on to last a long time without inconveniences and accidents if used in the correct way: for this reason, it is necessary to read carefully these pages before setting up and using the machine.

The manual, or a copy of it, must always be on the machine to be consulted by the user.



Pay attention to this symbol; it indicates the most dangerous operations and situations.

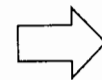

This symbol points out a note or a very important warning.

### Machine identification

The machine is identified by the data which are indicated in the label.

The label is stuck on the frame and it is well visible (fig. 1); it carries the following data:

- Model**
- Serial No**
- Year**
- Weight**
- R.p.m. max./1'**

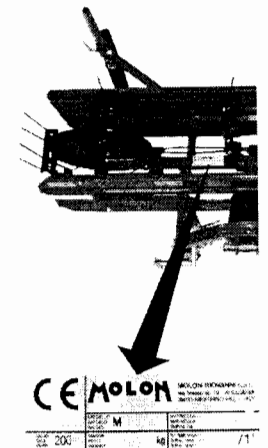

Fig. 1

## WARRANTY

The warranty is valid for those parts of the machine which present manufacturing or assembly defects according to the manufacturer's opinion.

The validity of the warranty covers a period of 12 months from the date of the purchase.

The warranty does not cover the parts which are subjected to wear and tear (teeth, plastic bearings, wheels), the breaking caused by carriage, inexperience, carelessness, alteration and negligence and the possible injuries to people or things caused by the use of the machine.

The warranty declines in case of a different use from the described one.

Check the machine at the time of delivery to verify if it has been damaged during the transport.

Possible claims for damages must be put down in writing and sent to the dealer within 8 (eight) days from the delivery.

The warranty declines if the instructions given in this manual are not respected; moreover, it declines if the machine undergoes a change or if unoriginal spare parts are used.

The court of Padua is competent for every controversy.

## INDEX

INTRODUCTION	page 1
Guide to the consultation	page 1
Machine identification	page 1
WARRANTY	page 2
MACHINE EMPLOYMENT	page 4
ACCIDENT PREVENTION MEASURES	page 4
USE OF THE MACHINE	page 6
Checks and advice before starting to work	page 6
The controls	page 6
Guide for the user	page 7
Adjustments for the use	page 7
Bad working and failure research	page 8
MAINTENANCE	page 8
Periodical maintenance	page 8
Teeth replacement	page 8
Extraordinary maintenance	page 9
INACTIVITY	page 9
Setting for a stop	page 9
Restarting	page 9
MACHINE TRANSPORT	page 9
TECHNICAL DATA	page 10
DEMOLITION AND GETTING RID OF MACHINE	page 10
EC DECLARATION OF CONFORMITY	page 11

### MACHINE EMPLOYMENT

The machine is a hay-rake tedder. Use it only and exclusively for raking and tedding hay and cut grass.

The manufacturer declines any responsibility for a different use from the described one.

Familiarize yourself with the operating controls and the correct use of the machine.

 Never permit children or inexperienced to operate your machine.

 Avoid working whilst people, especially children and pets, are nearby. Keep in mind that the operator is responsible for accidents to people and to their property.

The user must know the characteristics and the safety procedures of the machine.

The accident prevention rules and any other requirement of safety and of occupational medicine must always be observed.

**The manufacturer declines any responsibility for possible damages deriving from any arbitrary change on the machine.**

 Do not get on the machine whilst working, nor have yourself carried by it.

### ACCIDENT PREVENTION MEASURES

Follow the instructions described on the labels stuck on the machine.

 Scour the area where the machine is to be used and remove all foreign matters (stones, wire, sticks, etc...).

Carry out the checks, the operations of maintenance, adjustment and repair when the machine is not working and is unhooked from the tractor.

In case of road haulage, the highway code rules have to be observed.

 Danger through rotating parts! It is absolutely forbidden to take away or to damage the guards and to use the machine without them.

 Danger through thrown objects! The machine can throw objects or stones that may lie on the ground.

 It is forbidden to stay within the working radius of 10 m.

 Do not carry out operations of cleaning or maintenance with engine on, nor with connected power take-off.

 While working in presence of dust, wear a mask and glasses to protect your throat and eyes if your tractor is lacking a cabin.

The acoustic pressure level is inferior to 70 dB.

The safety signals are (fig. 2):

A= Before the use of the machine, read the manual.

B= Danger through thrown objects; keep the safety distance.

C= Danger through drive belts; do not take away the guards with machine on.

D= Turn off the engine and take away the key before any operation of repair and maintenance.

The corresponding labels are stuck on the machine in the indicated places. (fig. 3)

These signals must always be visible and, when lost or illegible, they have to be replaced with original ones.

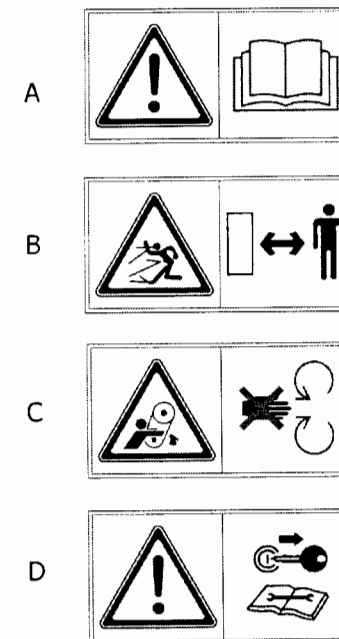

Fig. 2

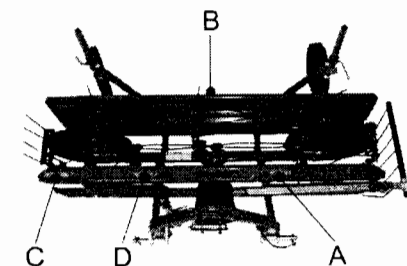

Fig. 3

Remember that a prudent operator is the best security against any accident.

## USE OF THE MACHINE

### Checks and advice before starting to work

The machine hooks directly to the three points of the tractor hydraulic lift.

➔ Every pin must be fixed with grip clips to avoid the unhooking.  
Fasten the supporting foot, which is near the connection, in high position, far from the ground.

Connect the cardan shaft when the tractor is off and the power take-off is unconnected; control the strength of the pins which do not permit the unhooking.

The power take-off of the tractor must not exceed the speed indicated on the machine (R.P.M. max./ 1').

Make sure the cardan shaft is open no less than 4 cm in maximum closing position; in case of maximum extension, the two parts of the cardan shaft must overlap no less than 15 cm (fig. 4).

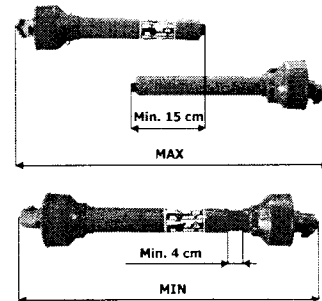

Fig. 4

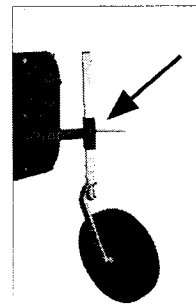

Fig. 5

### The controls

- each one of the supporting wheel has got a clamp for the height adjustment above ground level on the right or left side of the machine (fig. 5).

- the adjustable tie-rod of the third point regulates the position of the comb in the movement direction. Anyway, the comb must be parallel to the ground (fig. 6).

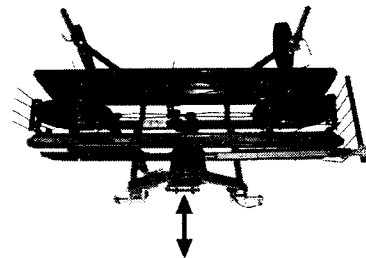

Fig. 6

### Guide for the user

#### - Hay rake -

Position the wheel levers at the same height until the combs skim the ground. Adjust the lateral rake to the width you want (fig. 7).  
Avoid stopping near the row when the combs are moving; if you need to, lift up the hydraulic lift.

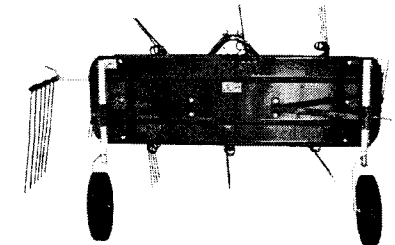

Fig. 7

#### - Tedder -

Position the wheels so that the machine results higher (3 or 4 cm) on the side of the hay unloading (fig. 8).  
Remove the lateral rake.

➔ The maximum speed of advance is 15 Km/h.

### Adjustments for the use

➔ Before starting to work, control that the teeth are in good condition and well fixed.

In case of breaking of some teeth, you must buy the original spare parts (code 818).

Often control the plastic bearings and the bushings which drag the combs: these parts, which are subjected to wear and tear, must be replaced when their minimum thickness is 4 mm.

Their replacement, like any operation on the V-belts, must be entrusted to skilled workers.

➔ Make sure that the protective sheets are correctly fixed after each operation.

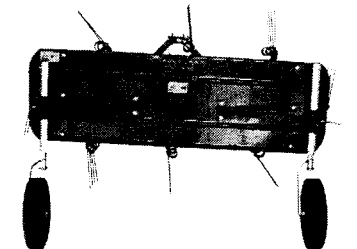

Fig. 8

*Bad working and failure research*

Inconvenience	Cause	Remedy	Danger
The combs drag the hay on the upper part	slow speed of the tractor	increase the speed	possible accumulation of hay on belts and pulleys
Accumulation of hay on belts and pulleys	incorrect use	unhook the machine from the tractor and remove the hay	never operate if the machine is connected to the tractor
The combs do not rotate	the drive belt is broken	replacement of the belt by skilled workers	never operate if the machine is connected to the tractor
The combs do not rotate	loosened belts	the belts have to be tightened by skilled workers	never operate if the machine is connected to the tractor

**MAINTENANCE**

*Periodical maintenance*

Any maintenance operation must be carried out by qualified workers according to what is written in this manual.



When you have to carry out an operation of maintenance, you must turn off the tractor engine and disconnect the power take-off.

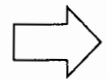

Only suitable tools must be used and they have to be in good condition.

Often grease (at least every 8 hours of work) the parts which are provided with grease cups located near the wheel axles (fig. 9).

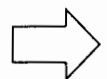

Never grease the belts and the plastic parts!

Control that the thickness of the plastic parts is superior to 4 mm. Control the tyre pressure (2,5 bar).

*Teeth replacement*

To replace a couple of teeth (code 818) you must loosen the nut (code 133)

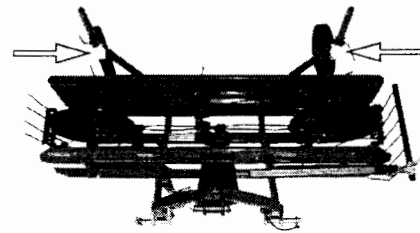

Fig. 9

which locks the connecting tang (fig. 10). Replace the new couple of teeth and take care of the perfect joint between the tang and the seat on the comb which carries the teeth; then fasten the nut strongly.

*Extraordinary maintenance*

Any operation of extraordinary maintenance must be carried out by skilled workers and it consists on the control of the V-belt conditions and also, if necessary, on the tightness or replacement of the belts, on the check of wear and tear of plastic parts with possible replacement of these last if their thickness is inferior to 4 mm.

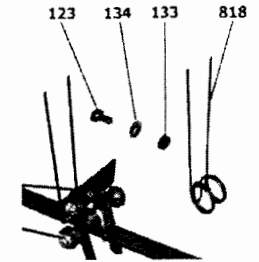

Fig. 10

**INACTIVITY**

*Setting for a stop*

Clean the machine when it is unhooked from the tractor and remove possible hay, remnants and dust, then do the operations of ordinary maintenance.

Cover the points of the teeth which are turned up with the proper accident preventive protections the machine is provided with (fig. 11).

Block the machine to avoid displacements caused by accidental collisions.

The user will benefit from finding the machine in perfect conditions when he starts working again.

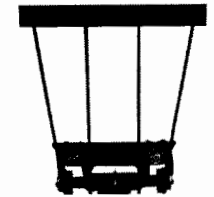

Fig. 11

*Restarting*

Control the tyre pressure (2,5 bar) and remove the protections from the teeth.

**MACHINE TRANSPORT**

The machine can easily be lifted by a crane through two belts, type- tested for its weight, which must be placed, the first on the three point connection and the other on the connection longitudinal frame members of the wheels (fig. 12).

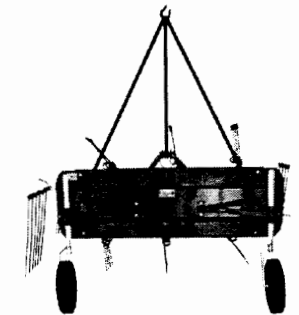

Fig. 12

The points of belt placement are indicated on the machine by proper labels (fig. 13). For the operations of loading and unloading, the machine must be placed on a level ground with sufficient surrounding space.



Fig. 13

Technical data

Model	Combs no.	Teeth per comb no.	Working width cm	Maximum width cm	Length cm
MINOR MINI 120	8	4	120	150	100

**DEMOLITION AND GETTING RID OF THE MACHINE**

Proceed to demolition and getting rid of the machine according to the regulations in force so as to avoid ecological damages.

**EC DECLARATION OF CONFORMITY**

**MOLON GIOVANNI s.n.c.**

Via Mestrina 10  
35035 MESTRINO PD ITALY

**We declare on our exclusive responsibility that the product:**

**HAY RAKE          MINOR MINI 120**

**to which this declaration refers is in conformity with the provisions of 2006/42/EC Directive of 17 May 2006. Used standards: UNI EN ISO 12100; EN 953.**

Person authorised to compile and draw up the technical file:  
Dr. Ing. Molon Bruno

Address:  
Via Mestrina 10  
35035 MESTRINO PD ITALY

Mestrino, 29 December 2009