

Memo

Type of product	Doublestar		
Date of purchase			
Name		Tel	
Address			



REVERSE OSMOSIS SYSTEM

Double Star USER'S MANUAL

- 01 Introduction of Double Star
- 02 What is Reverse Osmosis
- 03 Components & Other selections
- 04 Cartridge filters
- 05 The parts of Double Star
- 06 Tubing connection diagram
- 07 Installation diagram
- 08 Change filters
- 09 Change membrane
- 10 Operation regulation
- 12 FAQ
- 13 How UV works
- 14 Maintenance checking list
- 15 Memo

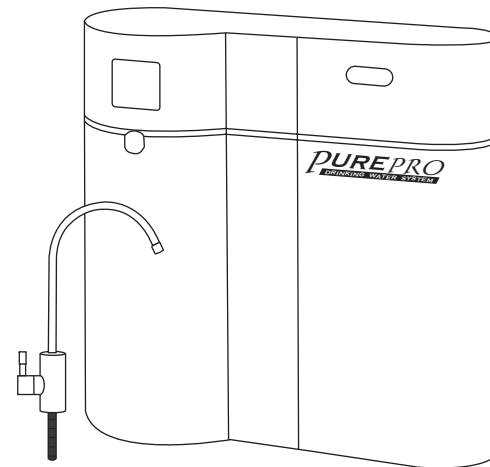

Thank you very much for selecting Pure-Pro Water Corp.
In order to bring the best use of your system, please read the user's manual carefully before installation and follow the regulations.

Introduction of Double Star

◆ Double Star- Chic Countertop RO System

As a smart and chic countertop RO system, Double Star is especially designed for homes, offices, restaurants, and shops use. It is the most delightful RO system invention of 21 century. This revolutionarily new PurePro compact system is easy to use and install as an under sink type or a countertop one. With superior quality of reverse osmosis, ultraviolet and carbon filtration to put refreshing, clean water at your fingertips.

Moreover, without tools, no mess, and no technician, the individual sanitary quick-change cartridges make it easier to maintain.

◆ Features & Specifications

- Production: 80 GPD / 300 LPD
- 3.2 gallons NSF standard water storage tank
- Safety approval: tuv (en60950) & ce mark
- With a transformer, available in 110volt, 220volt or 240volt (50/60hz)
- Input in ac 110volt, 220volt or 240volt (50/60hz); output in dc24v
- Operation pressure: 10 -100 psi
- UV stainless steel. 1 gallon per minute / 3.8 liters per minute flow rate
- Automatic shut-off valve
- Flow restrictor, stainless steel check valve
- Long reach attractive faucet
- Feed water connector & deliver valve
- Drain saddle valve
- Quick-connect fitting
- Four color coded 1/4 inch tubing for system connection
- Completely assembled & water leaking testing
- 100% factory tested and sterilized ready for installation.
- Water storage tank: 4.5gallons / 17 liters
- Dimensions: (cm) 35 (l) x 35(w) x 15 (h) - system
(cm) 28 (l) x 35 (w) x 28 (h) - tank
- Weight: 10 kg - system
4 kg - tank
- Max. inlet water temperature: 46

Suitable for: countertop / under sink

Double Star- Chic Countertop RO System



Maintenance checking list

Filters	1st stage	2nd stage	3rd stage	4th stage	5th stage	6th stage
Date						

Double Star- Chic Countertop RO System



How UV works

Using UV radiation in this manner to purify water is popular among Europeans who have known about it for decades. It's used in the United States started in the early 1990s and is becoming more prevalent especially with outbreaks of drinking water contamination by microorganisms. The UV purification system incorporates a lamp of suitable size and wattage to generate light of the proper wavelength with an electronic ballast to operate it. The electronic ballast plays an important role in how much UV the lamp generates. Dosage is a function of UV wavelength, intensity and time. Light intensity from the lamp is proportional to the electric current flowing through it, and is also affected by the frequency at which it's operated. Both of these parameters are controlled by the electronic ballast. Since many water purification systems are portable, they sometimes require power supplied from a battery rather than the typical AC source, i.e., 220-volt outlet. The electronic ballast must be able to accommodate applications with this requirement. Some of the other features users might expect from the electronic ballast are small physical size, long life and high efficiency.

At least one line of electronic ballasts can help meet these requirements. It can operate a wide variety of germicidal lamps from a number of different power supply voltages including both AC and DC (battery) sources. Many models are compact in size and can be easily incorporated into most designs. Probably one of the most attractive features of the product line is that nearly any model can be customized for a specific lamp to generate different levels of UV radiation. In some cases, new or specialty lamps require new ballast designs. In these instances, engineers can often create designs that meet or exceed customer needs. UV irradiation is becoming a more viable and economical means of water purification when used in conjunction with other methods.

Install UV lamp :

1. Take out the UV sterilizer from the box as shown in the picture.

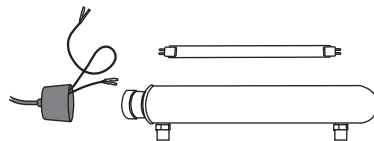

2. Connect the wire to both ends of UV lamp.



3. Tight up the UV cap.



Double Star- Chic Countertop RO System

PUREPRO
DRINKING WATER SYSTEM

What is reverse osmosis

Reverse osmosis was originally designed to make sea water drinkable for the navy. It is ideal for anyone on a low sodium diet. An R.O. membrane has a pore size much smaller than bacteria virus, or the cryptosporidium parasite. When functioning properly it will remove all microorganisms from tap water and produce sterile water. Reverse osmosis is the reversal of the natural flow of osmosis. In a water purification system, the goal is not to dilute the salt solution, but to separate the pure water from the salt and other contaminants. When the natural osmotic flow is reversed, water from the salt solution is forced to pass through the membrane in the opposite direction by application of pressure-thus the term REVERSE OSMOSIS. Through this process, we are able to produce pure water by screening out the salts and other contaminants.

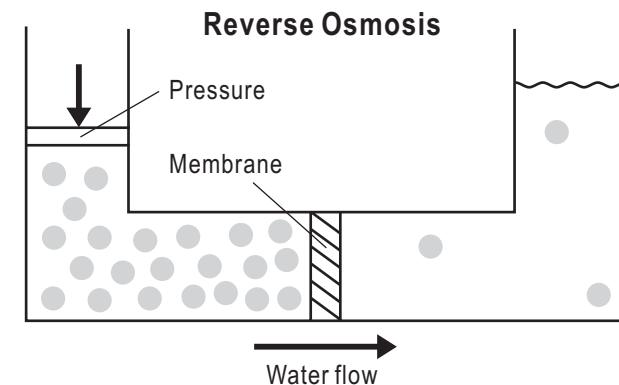

Double Star- Chic Countertop RO System

PUREPRO
DRINKING WATER SYSTEM

Components & Other selections

◆ Components

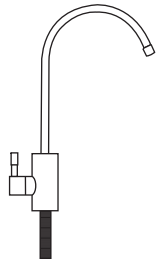

European ceramic faucet

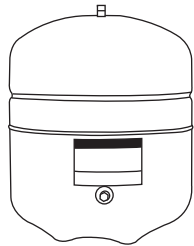

3.2G water storage tank



Housing wrench

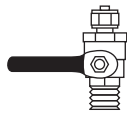

Deliver-valve

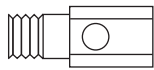

Water supply connector

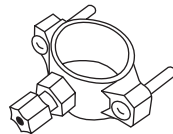

Drain saddle

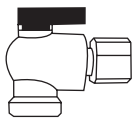

Tank ball shut-off valve

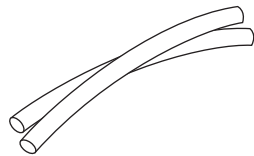

Four color coded 1/4 inch tubing for system connection

◆ Other selections

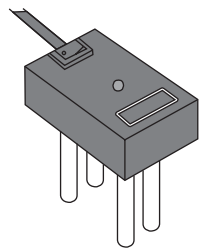

Color Tester

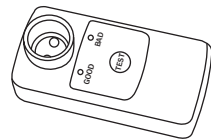

Mini TDS

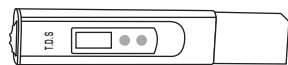

TDS meter

Double Star- Chic Countertop RO System

PUREPRO
DRINKING WATER SYSTEM

FAQ

Q: What is the guarantee on the Pure-Pro system ?

The Pure-Pro System (excluding filters) is guaranteed for 1 year for material and workmanship. All defective parts will be replaced free within the first year under natural breakdown. The membrane has one year pro-rated guarantee.

Q: What factors affect the quantity and the quality of the water production?

There are four major variables to consider:

- 1. Pressure**-The greater the water pressure, the better water quantity and quality it produced. Water pressure of 60 PSI is ideal.
- 2. Temperature**-76°F is the ideal water temperature for R.O. 40°F water will cause the production of R.O. water to fall to half of that at 76°F. The maximum water temperature recommended is 85°F.
- 3. Total Dissolved Solids (TDS)**-The higher the amount of dissolved contaminants in the water, the lower the quantity of water produced. A high level of TOTAL DISSOLVED SOLIDS can be overcome with additional water pressure.
- 4. Membrane**-Different membranes have different characteristics. Some produce more water than others; some have better contaminant rejection capabilities; some have greater resistance to chemical abrasion for longer life. Pure-Pro system includes RE1812-70 The Thin Film Composite (TFC) membranes combine the best of these characteristics and are considered the finest membrane in the world.

Q: Can the Pure-Pro system be connected to an extra faucet?

It only takes a 1/4" tee and tubing to run the water to a refrigerator or a extra faucet. Some families run Pure-Pro system to all of their bathrooms.

Q: What is the maintenance schedule for the Pure-Pro System ?

The three pre-filter cartridges should be changed every 6 months. The 5 micron sediment cartridge filter is the first one; the second is a carbon cartridge filter, and the third one is a 1 micron sediment filters. (some systems comes with the Extruded carbon filter.) Failure to change the cartridge every 6 months may cause chlorine to destroy the membrane.

Double Star- Chic Countertop RO System

PUREPRO
DRINKING WATER SYSTEM

Operation regulation







- A. With everything connected, turn on the water check for leaks.
- B. Make sure the storage tank shut-off valve is "OFF". Open the sink top faucet.
- C. Within a few minutes (up to 15) the water will start to run from the faucet slowly.
- D. Let the water run for at least 30 minutes. This flushes the carbon filters on first time use.
- E. After initial flushing, open the shut-off valve on the tank and close the sink top faucet.
- F. Tank will now full of water (usually 2 to 3 hours) after the tank has filled. Open the sink top faucet and drain all water until the storage tank is empty and there is only a small flow from the sink top faucet. *** DO NOT USE FIRST TANK OF WATER. ***
- G. Close the sink top faucet. The system is now ready for use.
- H. Change filters regularly every 6 to 12 months and have the membrane checked annually.

Caution

1. Do not use hot water (over 45°C)!
2. Do not freeze the machine!
3. Switch off electricity and water source if away for more than 5 days, and drain out pure water.

Double Star- Chic Countertop RO System

Cartridge Filters

Cartridge Filters	Filter Description	Service Life
<p>Stage 1</p> <p>Inline 1 Micron Sediment Filter</p> 	<p>This 1micron sediment filter is made by Dupont Anti-Bacteria. High capacity filter removes dusts, particles and rusts, 99.70% anti-bacterial, comply with FDA test standard. Use 100% pure PP fine fiber. Product series have been passed the test in accordance with the filtering effect test of ANSI-NSF standard 42 - particulate reduction class II-V of U.S.A. Service Life: 1500GAL</p>	6 Months
<p>Stage 2</p> <p>Inline Activated Carbon Filter</p> 	<p>This granular activated carbon filter is composed of high-performance activated carbon that removes free chlorine, odor, organic contaminants, pesticides, and chemicals that contributed to taste and odor. Service Life: 1500GAL</p>	6 Months
<p>Stage 3</p> <p>Inline Activated Carbon Filter</p> 	<p>This granular activated carbon filter is composed of high-performance activated carbon that removes free chlorine, odor, organic contaminants, pesticides, and chemicals that contributed to taste and odor. Service Life: 1500GAL</p>	6 Months
<p>Stage 4</p> <p>Flimtec Membrane</p> 	<p>Filmtec (Dow Chemical) membranes, maker of the world's most advanced reverse osmosis membranes. High rejection membrane with the capacity of producing 80 gallons per day. Eliminates up to 99.9% of most chemicals, dissolved solids, metals, bacteria, and viruses. Service Life: 10000GAL</p>	4 Years
<p>Stage 5</p> <p>Post Carbon Filter</p> 	<p>This post carbon filter is designed to improve taste. It removes any residual impurities and odors and provides a finer conditioning of pure water. Service Life: 3000GAL</p>	1 Year
<p>Stage 6</p> <p>Ultraviolet Water Sterilizer</p> 	<p>Ultraviolet light (UV), a natural part of the sunlight is widely accepted as a reliable, efficient & environmentally friendly solution for water disinfection. This UV lamp utilize the application of particularly efficient UV radiator with a 254nm wave length to cause immediate death for organisms and wipe out their ability to survive and reproduce. 99.99% Destruction Of Bacteria And Viruses.</p>	1 Year

Double Star- Chic Countertop RO System

The parts of Doublestar

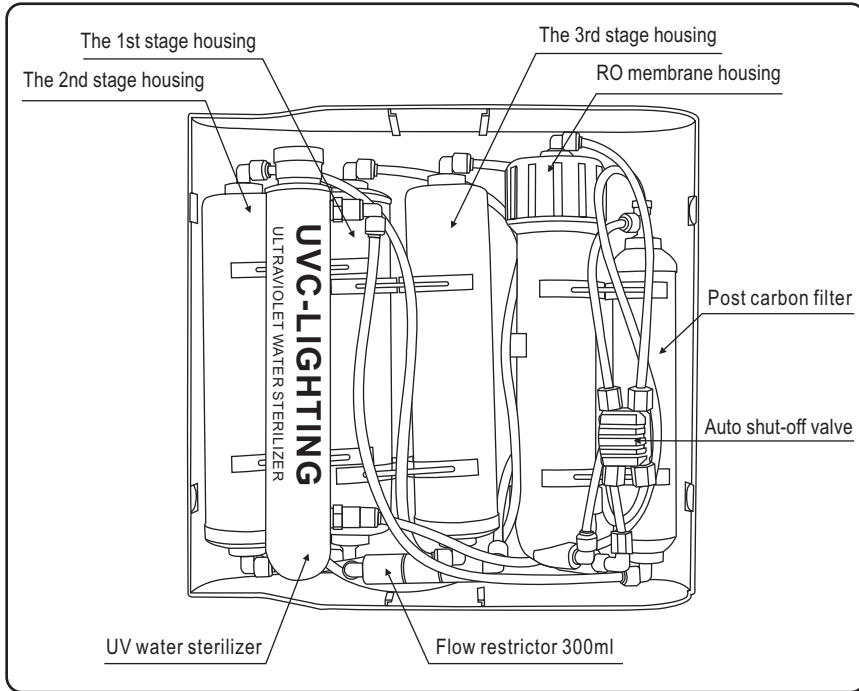

Front part

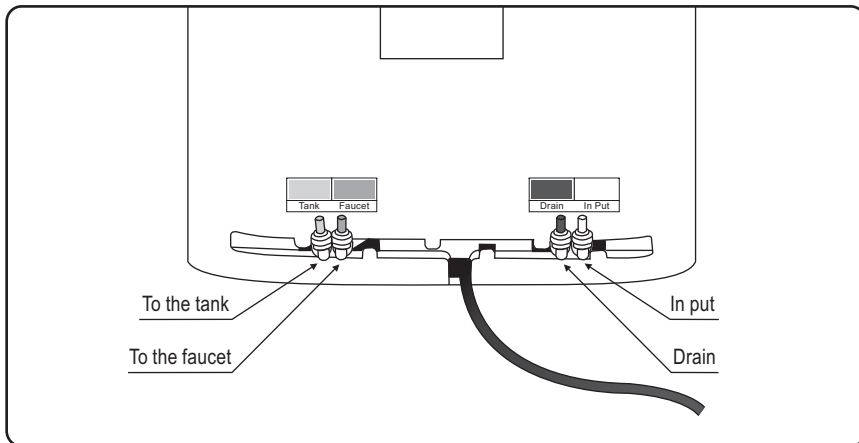

Reverse part

Double Star- Chic Countertop RO System

Operation regulation

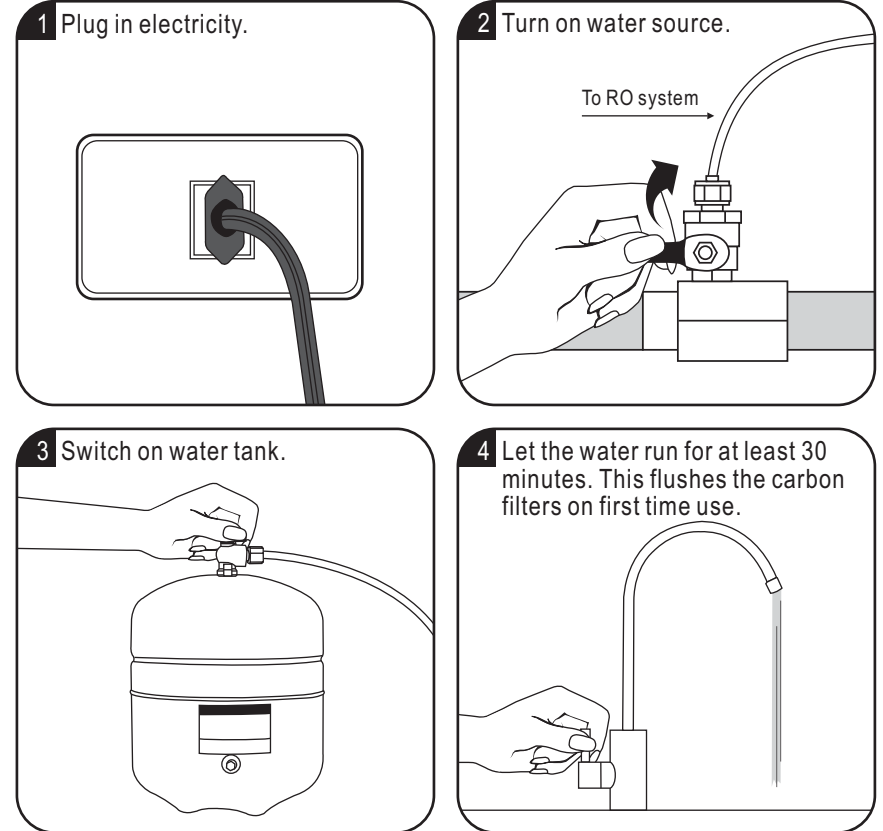

Double Star- Chic Countertop RO System

Change membrane

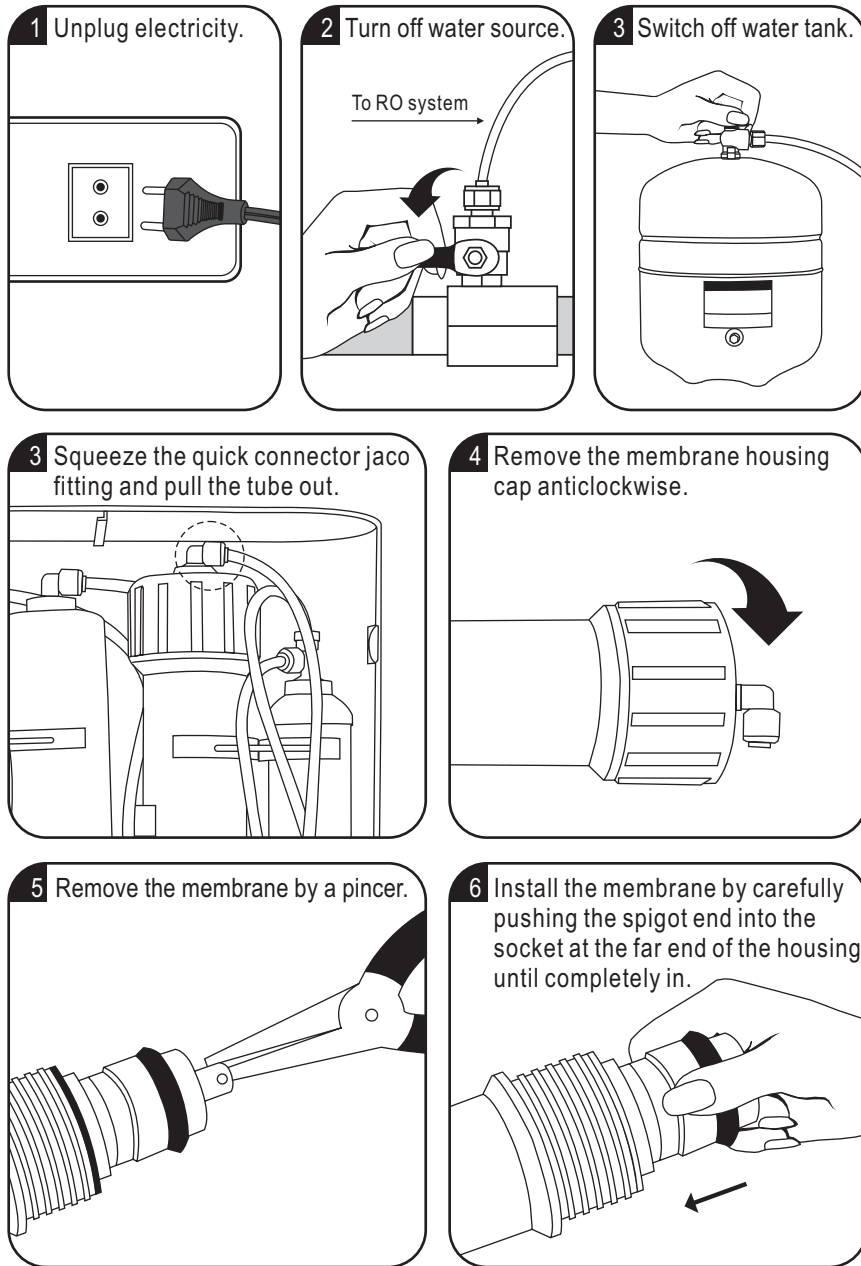

Double Star- Chic Countertop RO System

PUREPRO
DRINKING WATER SYSTEM

Tubing connection diagram

CONNECTING THE COLOR TUBING:

- A. Connect the WHITE tubing to the water supply connector.
- B. Connect the BLUE tubing to the sink top faucet.
- C. Connect the BLACK tubing to the drain saddle.
- D. Connect the RED tubing to the storage tank.

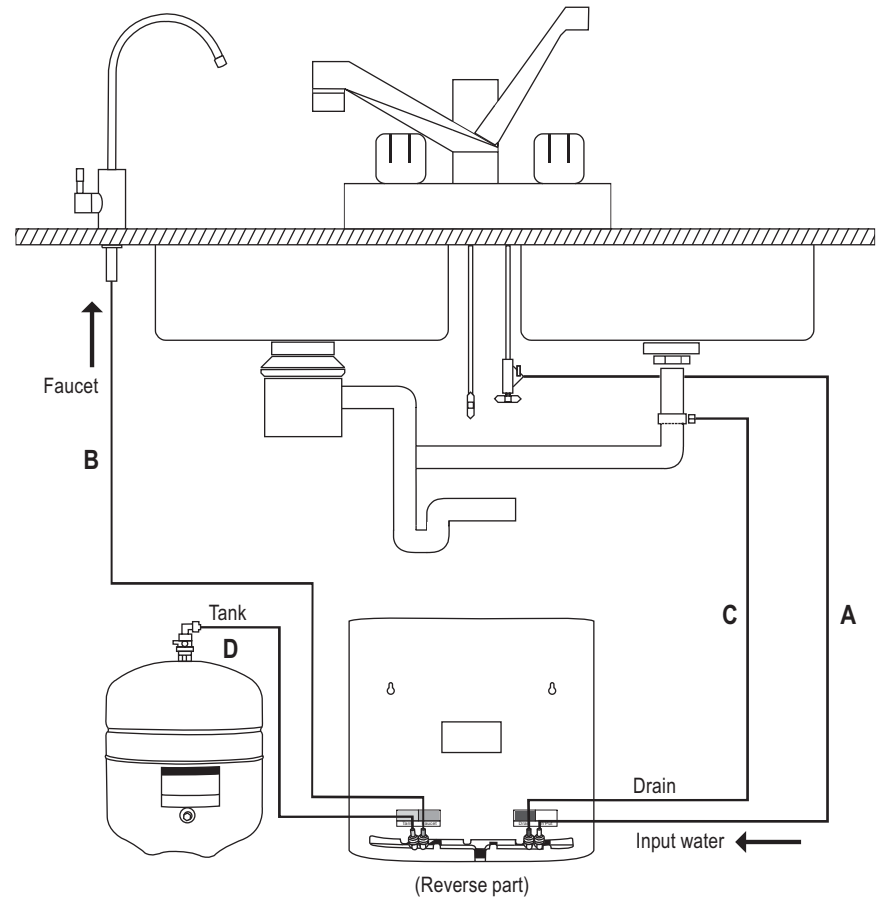

Double Star- Chic Countertop RO System

PUREPRO
DRINKING WATER SYSTEM

Installation diagram

Input water :

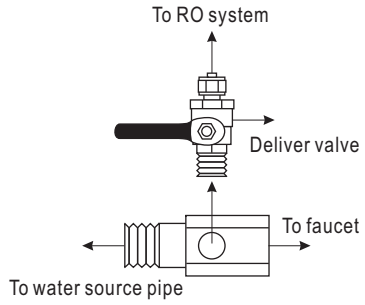

Install water tank :

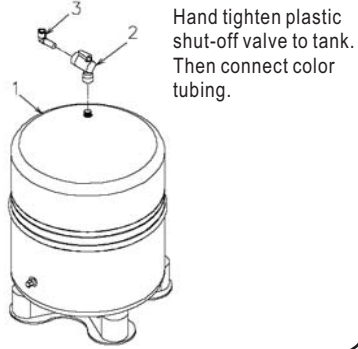

Install European ceramic faucet :

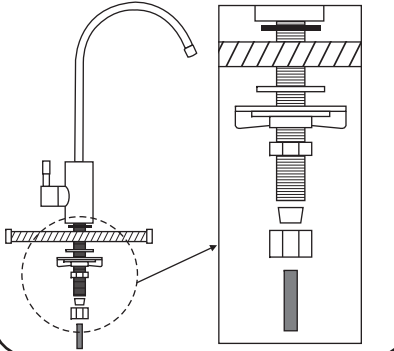

Install drain saddle :

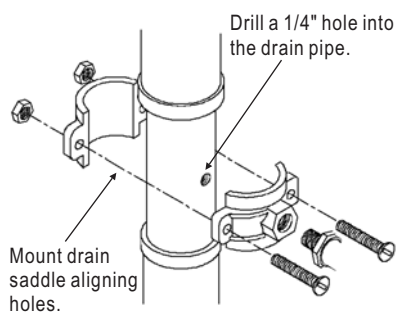

Assemble membrane :

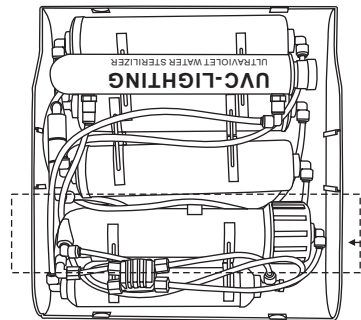

1. Remove the membrane housing cap.
2. Replace the membrane.



Double Star- Chic Countertop RO System

Change filters

1 Unplug electricity.

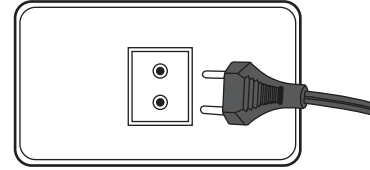

1 Turn off water source.

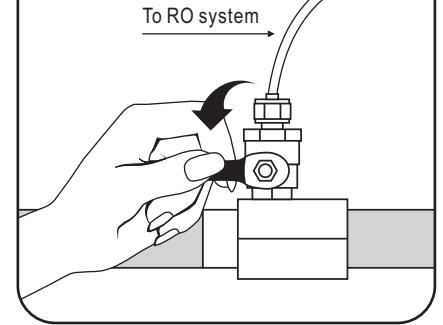

3 Switch off water tank.

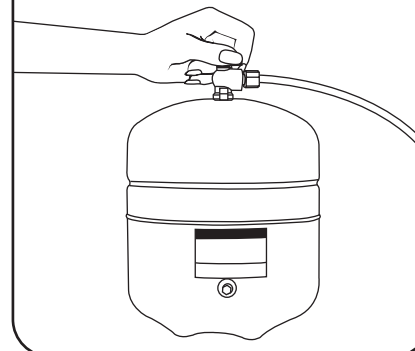

5 Squeeze the quick connector jaco fitting and pull the tube out. Loose the jaco fitting from the filter. Then replace the filter.

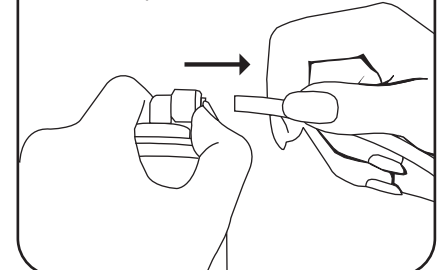

6 Tight up the jaco fitting after changing the filter. Push the tube bank into the quick connector jaco fitting.

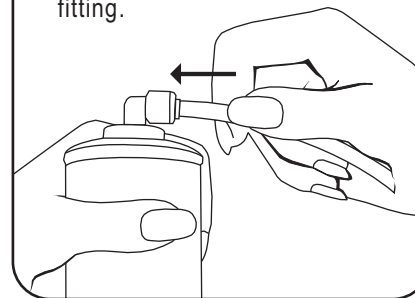

7 Drain out 1 Gallon of water to purify replacement filters.

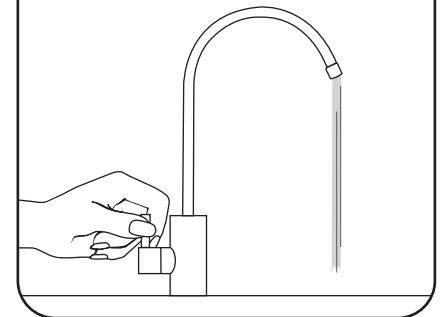

Double Star- Chic Countertop RO System