

Impulse™ 648

User Manual

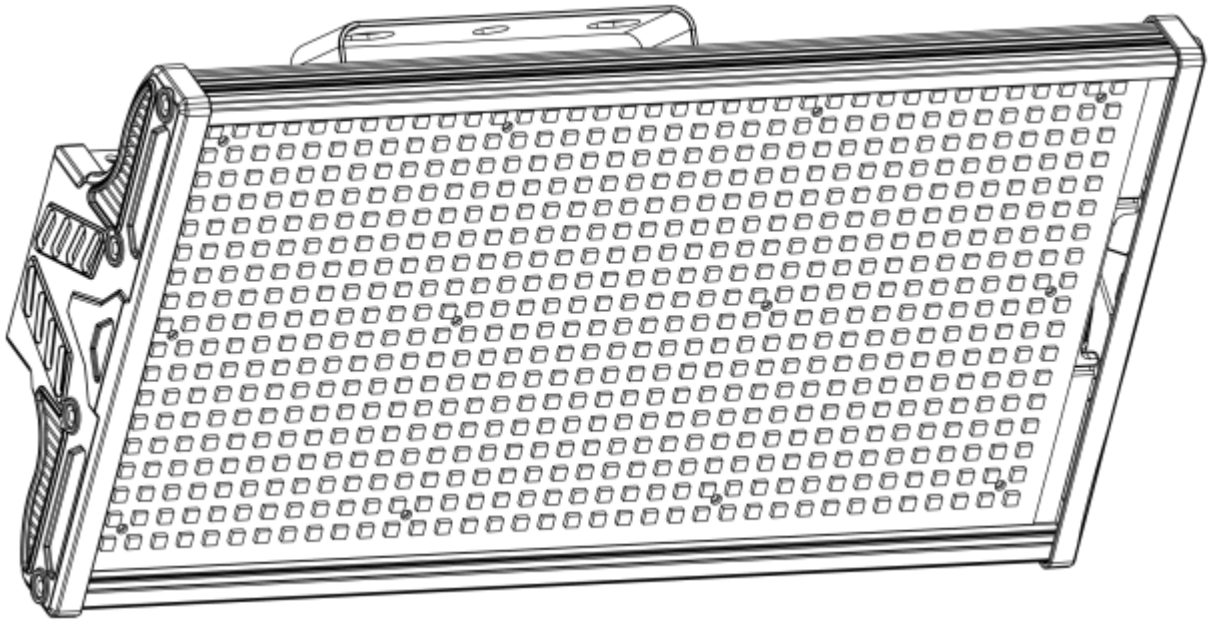

CHAUVET®
Value • Innovation • Performance
It's Green Thinking

TABLE OF CONTENTS

1. Before You Begin	4
What Is Included	4
Unpacking Instructions	4
Claims	4
Text Conventions	4
Icons	4
Document Information	4
Product at a Glance	5
Safety Notes	5
2. Introduction	6
Product Overview	6
Product Dimensions	7
3. Setup	8
AC Power	8
Fuse Replacement	8
Power Linking	9
Mounting	10
Orientation	10
Rigging	10
4. Operation	11
Control Panel Operation	11
Menu Map	11
Configuration (DMX)	11
Starting Address	11
Configuration (Standalone)	12
Sound Active Mode	12
Manual Control Mode	12
Master/Slave Mode	13
DMX Channel Assignments and Values	13
2-CH	13
5. Technical Information	14
Product Maintenance	14
General Troubleshooting	15
Contact Procedure	16
CHAUVET® Contact Information	16
Returning Products to CHAUVET®	16

DMX Primer	17
Introduction	17
The Physical Medium.....	17
The Signals	17
DMX Universes	17
The Functions	17
DMX Configuration.....	18
Personalities.....	18
Starting Address.....	18
Assigning Addresses.....	18
DMX Connectivity.....	18
Fixture Location.....	18
Number of Fixtures.....	19
DMX Data Cabling	19
Making Your Own DMX Cable	19
DMX Cable Characteristics	19
DMX Cable Connectors	19
3-Pin to 5-Pin Conversion Chart.....	20
DMX Connection	20
6. Technical Specifications	21

1. BEFORE YOU BEGIN

What Is Included

- 1 x Impulse™ 648
- 1 x Power Cord
- 1 x Warranty Card
- 1 x Quick Reference Guide

Unpacking Instructions

Immediately upon receipt, carefully unpack the product and check the container to make sure you have received all the parts indicated above in good condition.

Claims



If the container or the material inside the container (the product and included accessories) appear damaged from shipping, or show signs of mishandling, notify the carrier immediately, not CHAUVET®, upon receipt. Failure to do so in a timely manner may invalidate your claim with the carrier. In addition, keep the container and all the packing material for inspection.

For other issues such as missing components or parts, damage not related to shipping, or concealed damage, file a claim with CHAUVET® within seven (7) days of receiving the merchandise.

Text Conventions

Convention	Meaning
1~512	A range of values
50/60	A set of values of which only one can be chosen
Settings	A menu option not to be modified
Menu > Settings	A sequence of menu options to be followed
<ENTER>	A key to be pressed on the product's control panel
ON	A value to be entered or selected

Icons

Icon	Meaning
	This paragraph contains critical installation, configuration, or operation information. Failure to comply with this information may render the product partially or completely inoperative, cause damage to the product, or cause harm to the user.
	This paragraph contains important installation or configuration information. Failure to comply with this information may prevent the product from functioning correctly.
	This paragraph reminds you of useful, although not critical, information.

Document Information

The information and specifications contained in this document are subject to change without notice. CHAUVET® assumes no responsibility or liability for any errors or omissions that may appear in this manual. CHAUVET® reserves the right to update the existing document or to create a new document to correct any errors or omissions.

You can download the latest version of this document from www.chauvetlighting.com.

© Copyright 2011 CHAUVET®. All rights reserved

Electronically published by CHAUVET® in the United States of America

Author	Date	Editor	Date
A. Diaz	09/26/11	B. Pillow	09/28/11

Product at a Glance

Use on Dimmer	⊘	Auto Programs	✓
Outdoor Use	⊘	Auto-ranging Power Supply	✓
Sound Activated	✓	Replaceable Fuse	✓
DMX	✓	User Serviceable	⊘
Master/Slave	✓	Duty Cycle	⊘

Safety Notes

Please read the following Safety Notes carefully before working with the product. The Notes include important safety information about installation, usage, and maintenance.



- Always connect the product to a grounded circuit to avoid the risk of electrocution.
- Always disconnect the product from the power source before cleaning or replacing the fuse.
- Avoid direct eye exposure to the light source while the product is on.
- Make sure the power cord is not crimped or damaged.
- Never disconnect the product from power cord by pulling or tugging on the cord.
- If mounting the product overhead, always secure to a fastening device using a safety cable.
- Make sure there are no flammable materials close to the product when operating.
- Do not touch the product's housing when operating because it may be very hot.



- Always make sure that the voltage of the outlet to which you are connecting the product is within the range stated on the decal or rear panel of the product.
- The product is for indoor use only! (IP20) To prevent risk of fire or shock, do not expose the product to rain or moisture.
- Always install the product in a location with adequate ventilation, at least 20 in (50 cm) from adjacent surfaces.
- Be sure that no ventilation slots on the product's housing are blocked.
- Never connect the product to a dimmer.
- Make sure to replace the fuse with another of the same type and rating.
- Never carry the product from the power cord or any moving part. Always use the hanging/mounting bracket or the handles.
- The maximum ambient temperature is 104° F (40° C). Do not operate the product at higher temperatures.
- In the event of a serious operating problem, stop using the product immediately.
- Never try to repair the product. Repairs carried out by unskilled people can lead to damage or malfunction. Please contact the nearest authorized technical assistance center.



- Keep this User Manual for future consultation. If you sell the product to another user, be sure that they also receive this document.

2. INTRODUCTION

Product Overview

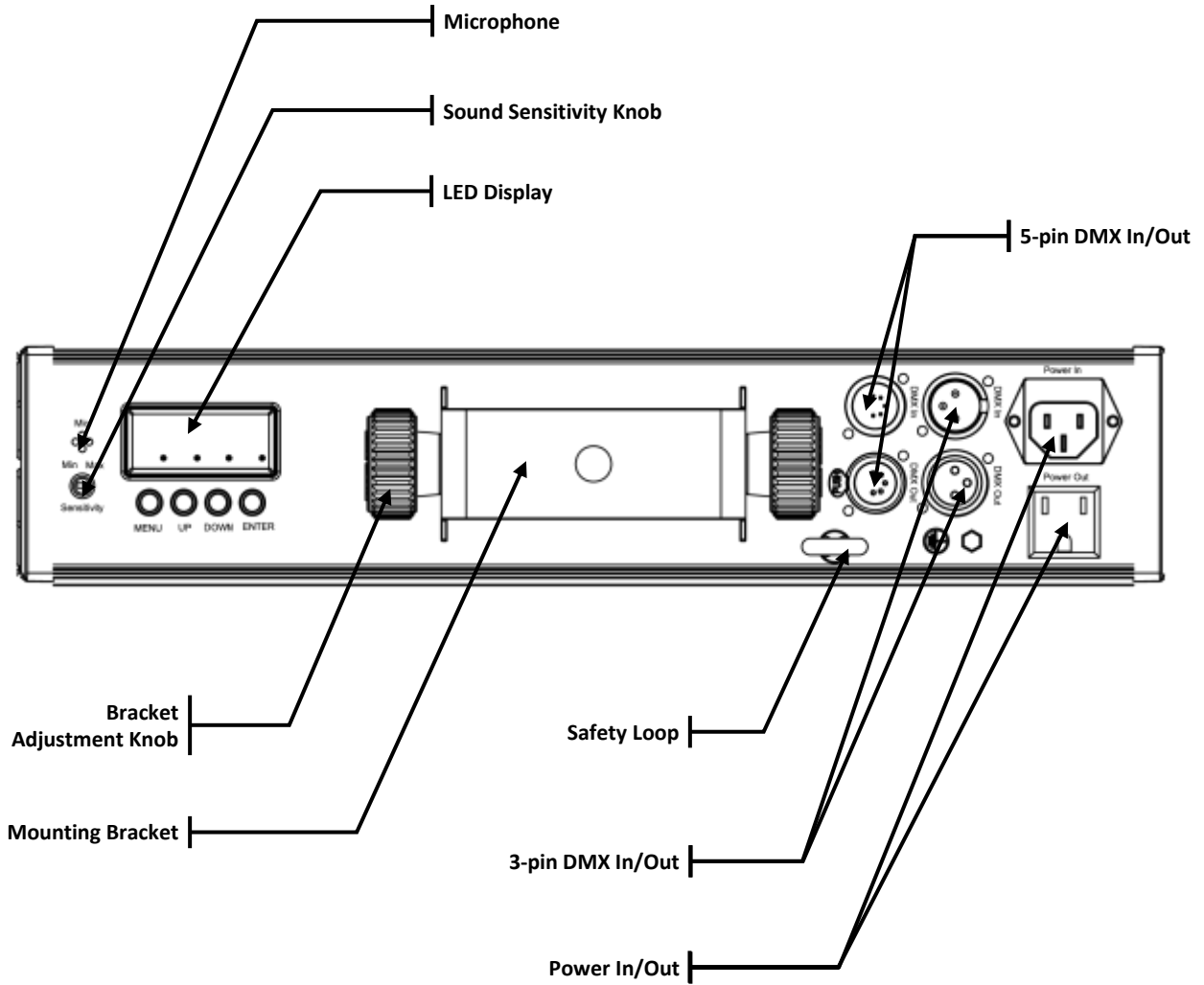

Product Dimensions

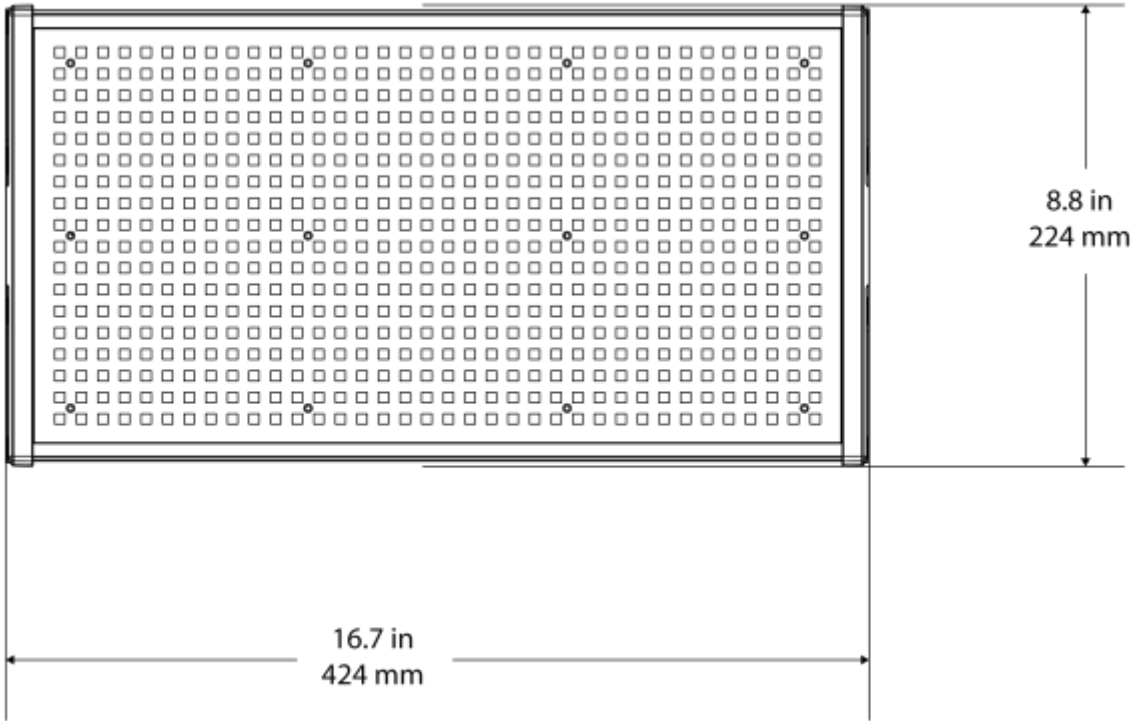
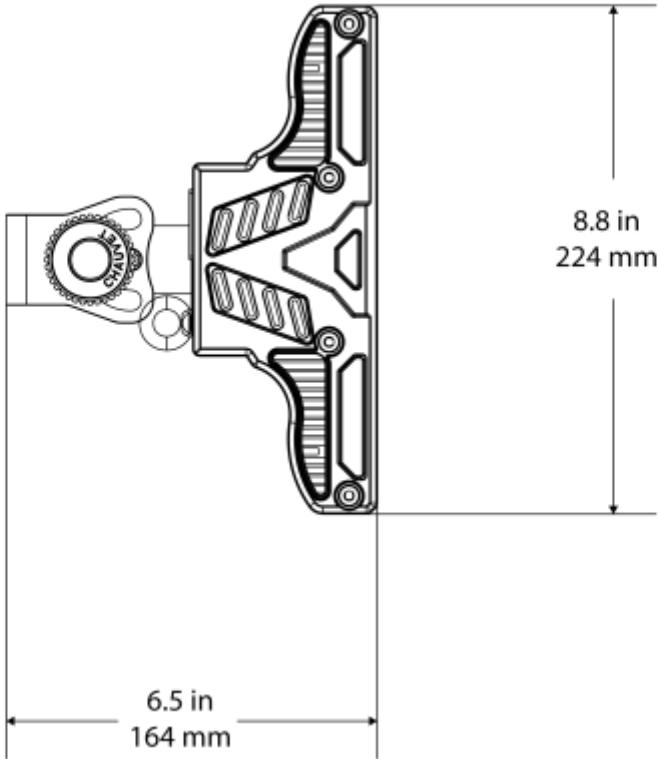

3. SETUP

AC Power The Impulse™ 648 has an auto-ranging power supply and can work with an input voltage range of 100~240 VAC, 50/60 Hz.

To determine the product's power requirements (circuit breaker, power outlet, and wiring), use the current value listed on the label affixed to the product's back panel, or refer to the product's specifications chart. The listed current rating indicates the product's average current draw under normal conditions.



Always connect the product to a protected circuit (circuit breaker or fuse). Make sure the product has an appropriate electrical ground to avoid the risk of electrocution or fire.



Never connect the product to a rheostat (variable resistor) or dimmer circuit, even if the rheostat or dimmer channel serves only as a 0 to 100% switch.

Fuse Replacement

Follow the instructions below to change the fuse, if necessary.



Disconnect the product from the power outlet before replacing the fuse.

1. Wedge the tip of a flat head screwdriver into the slot of the fuse holder.
2. Pry the fuse holder out of the housing.
3. Remove the blown fuse from the holder and replace with a fuse of the exact same type and rating.
4. Insert the fuse holder back in place and reconnect power.

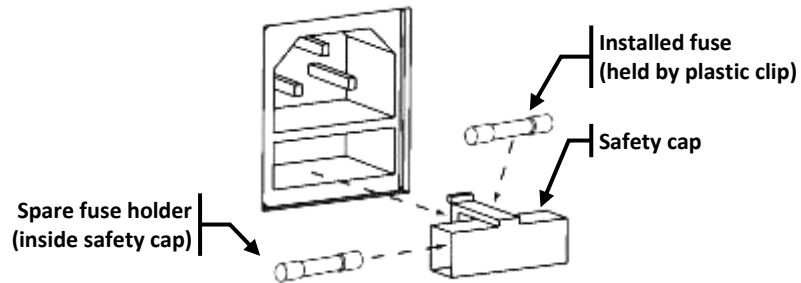

The product does not ship with a spare fuse; however, the safety cap has room for a spare.

Power Linking The product provides power linking via the Edison outlet located in the back of the unit. Please see the diagram below for further explanation.

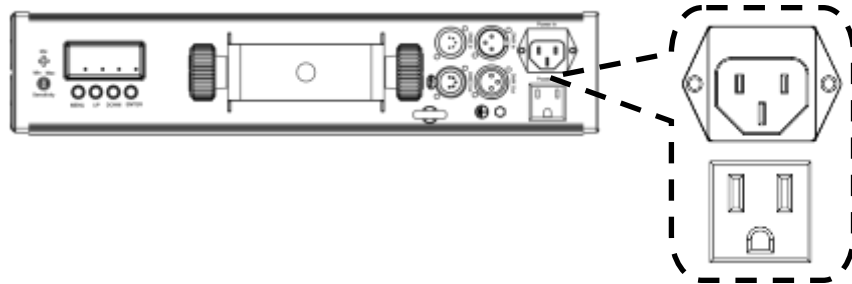

Power Linking Diagram

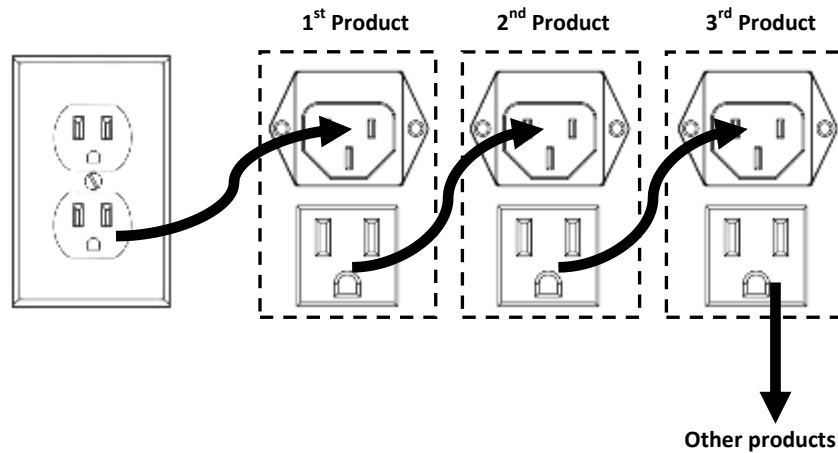

You can power link up to 5 Impulse™ 648 units on 120 VAC or up to 10 Impulse™ 648 units on 230 VAC.



The power linking diagram shown above corresponds to the North American version of the product **ONLY!** If using the product in other markets, you must consult with the local CHAUVET® distributor as power linking connectors and requirements may differ in your country or region.

Mounting Before mounting the product, read and follow the safety recommendations indicated in the *Safety Notes* section (page 2 of this manual).

Orientation The Impulse™ 648 may be mounted in any position; however, make sure adequate ventilation is provided around the product.

- Rigging**
- Before deciding on a location for the product, always make sure there is easy access to the product for maintenance and programming/fluid replenishment purposes.
 - Make sure that the structure or surface onto which you are mounting the product can support the product's weight. Please see the *Technical Specifications* section of this manual for weight information.
 - When mounting the product overhead, always use a safety cable. Mount the product securely to a rigging point, whether an elevated platform or a truss.
 - When rigging the product onto a truss, you should use a mounting clamp of appropriate weight capacity. The bracket has a 13 mm hole, which is appropriate for this purpose.
 - When power linking multiple products, you must always consider the length of the power linking cable and mount the products close enough for the cable to reach.
 - The bracket adjustment knobs allow for directional adjustment when aiming the product to the desired angle. Only loosen or tighten the bracket knobs manually. Using tools could damage the knobs.

Mounting Diagram

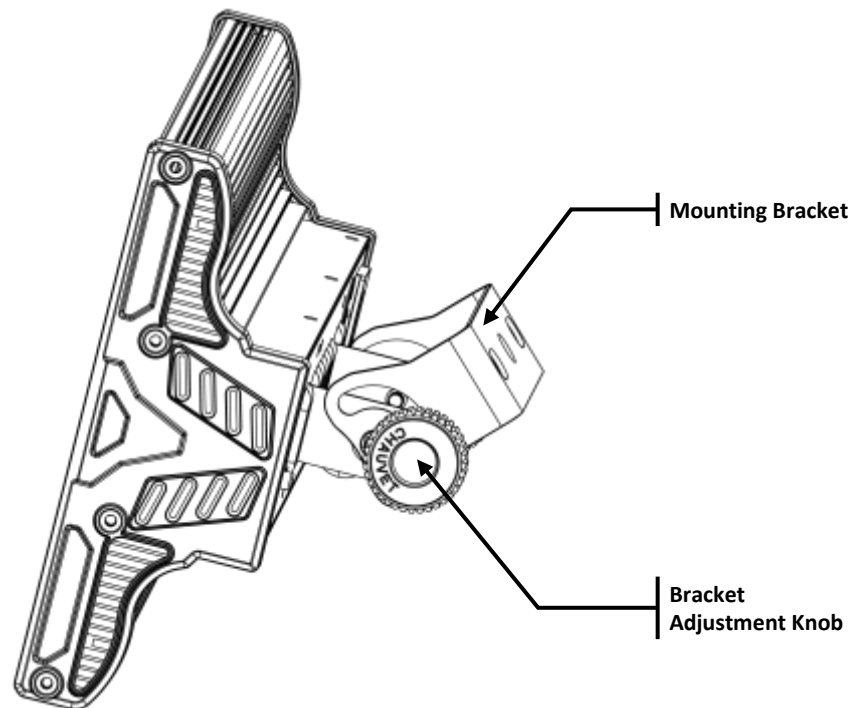

4. OPERATION

Control Panel Operation

To access the control panel functions, use the four buttons located underneath the display. Please refer to the Product Overview to see the button locations on the control panel.

Button	Function
<MENU>	Press to find an operation mode or to back out of the current menu option
<UP>	Press to scroll up the list of options or to find a higher value
<DOWN>	Press to scroll down the list of options or to find a lower value
<ENTER>	Press to activate a menu option or a selected value

Menu Map

Mode	Programming Steps		Description
<i>DMX Mode</i>	512	d_1-d512	Selects the DMX starting address
<i>Manual Control</i>	U--	d_0-d100	Controls manual dimmer
		S_0-S100	Controls manual strobe speed (0-30 Hz)
<i>Sound Active</i>	SUND		Turns on Sound Active mode

Configuration (DMX)

Set the product in DMX mode to control with a DMX controller.

1. Connect the product to a suitable power outlet.
2. Turn the product on.
3. Connect a DMX cable from the DMX output of the DMX controller to the DMX input socket on the product.

Starting Address

When selecting a starting DMX address, always consider the number of DMX channels the selected DMX mode uses. If you choose a starting address that is too high, you could restrict the access to some of the product's channels.

The Impulse™ 648 uses up to 2 DMX channels in its 2-channel DMX mode, which defines the highest configurable address to **511**.

If you are not familiar with the DMX protocol, you may refer to the *DMX Primer* section in the *Technical Information* chapter.

To select the starting address, do the following:

1. Press <MENU> repeatedly until **512** shows on the display.
2. Press <ENTER>.
3. Use <UP> or <DOWN> to select the starting address.
4. Press <ENTER>.

Configuration (Standalone)

Set the product in one of the standalone modes to control without a DMX controller.

1. Connect the product to a suitable power outlet.
2. Turn the product on.



Never connect a product that is operating in any standalone mode (either Static, Automatic, or Sound) to a DMX string connected to a DMX controller. Products in standalone mode may transmit DMX signals that could interfere with the DMX signals from the controller.

Sound Active Mode

To enable the Sound Active mode, do the following:

1. Press **<MENU>** repeatedly until **SUND** shows on the display.
2. Press **<ENTER>**.
3. Turn the music on and adjust the sound sensitivity knob until the product starts responding to the beat of the music.



The product will only respond to low frequencies of music (bass and drums).

Manual Control Mode

To control the Impulse™ 648 manually, follow the instructions below:

1. Press **<MENU>** repeatedly until **U--** shows on the display.
2. Press **<ENTER>**.
3. Use **<UP>** or **<DOWN>** when the display shows **d__0** to adjust the dimmer from off (**d__0**) to fully on (**d100**).
4. Press **<ENTER>**.
5. Use **<UP>** or **<DOWN>** when the display shows **S__0** to adjust the strobe speed between 0 Hz (**d__0**) to 30 Hz (**d100**).
6. Press **<ENTER>**.

Master/Slave Mode

The Master/Slave mode allows a single Impulse™ 648 unit (the “master”) to control the actions of one or more Impulse™ 648 units (the “slaves”) without the need of a DMX controller. The master unit will be set to operate in either Automatic or Sound Active mode, while the slave units will be set to operate in Slave Mode. Once set and connected, the slave units will operate in unison with the master unit.

Configure the units as indicated below.

Slave units:

1. Press **<MENU>** repeatedly until **512** shows on the display.
2. Press **<ENTER>** to accept.
3. Set the DMX address to **001**.
4. Connect the DMX input of the first slave unit to the DMX output of the master unit.
5. Connect the DMX input of the subsequent slave units to the DMX output of the previous slave unit.
6. Finish setting and connecting all the slave units.

Master unit:

1. Set the master unit to operate in either Automatic or Sound mode.
2. Make the master unit the first unit in the DMX daisy chain.



- **Configure all the slave units before connecting the master unit to the DMX daisy chain.**
- **Never connect a DMX controller to a DMX string configured for Master/Slave operation because the controller may interfere with the signals from the master unit.**
- **Do not connect more than 31 slave units to the master unit.**

DMX Channel Assignments and Values

2-CH	Channel	Function	Value	Setting
	1	Strobe Speed	000 ⇔ 255	0-30 Hz
	2	Dimmer	000 ⇔ 255	0~100%

5. TECHNICAL INFORMATION

Product Maintenance

Dust build up reduces light output performance and can cause overheating. This can lead to reduction of the light source's life. To maintain optimum performance and minimize wear, you should clean your lighting products at least twice a month. However, be aware that usage and environmental conditions could be contributing factors to increase the cleaning frequency.

To clean the product, follow the instructions below:

- Unplug the product from power.
- Wait until the product is cold.
- Use a vacuum (or dry compressed air) and a soft brush to remove dust collected on the external surface/vents.
- Clean all glass/transparent surfaces with a mild soap solution, ammonia-free glass cleaner, or isopropyl alcohol.
- Apply the solution directly to a soft, lint free cotton cloth or a lens cleaning tissue.
- Softly drag any dirt or grime to the outside of the glass/transparent surface.
- Gently polish the glass/transparent surfaces until they are free of haze and lint.



Always dry the glass/transparent surfaces carefully after cleaning them.

General Troubleshooting

Symptom	Possible Cause	Possible Action
Circuit breaker or fuse keeps blowing	<ul style="list-style-type: none"> Excessive load on the circuit 	<ul style="list-style-type: none"> Make sure that the total load does not exceed 80% of the breaker or fuse nominal current
	<ul style="list-style-type: none"> Short circuit along the power lines 	<ul style="list-style-type: none"> Check the power lines and power cords
Product does not power up	<ul style="list-style-type: none"> No energy on power outlet 	<ul style="list-style-type: none"> Check power outlet Change to another outlet
	<ul style="list-style-type: none"> Loose or damaged power cord 	<ul style="list-style-type: none"> Check the power cord
	<ul style="list-style-type: none"> Blown fuse 	<ul style="list-style-type: none"> Replace blown fuse with a good one of the same type and rating
	<ul style="list-style-type: none"> Internal problem 	<ul style="list-style-type: none"> Send product for repair
Product does not respond to DMX	<ul style="list-style-type: none"> Wrong starting address on the product 	<ul style="list-style-type: none"> Set the correct starting address on the product Use the right fader(s) on the controller
	<ul style="list-style-type: none"> Wrong DMX personality on the product 	<ul style="list-style-type: none"> Set the correct DMX product's personality Assign the faders accordingly
	<ul style="list-style-type: none"> Wrong polarity setting on the DMX controller 	<ul style="list-style-type: none"> Change the signal polarity on the controller
	<ul style="list-style-type: none"> Loose or damaged DMX cable 	<ul style="list-style-type: none"> Check the DMX cable before the faulty unit
	<ul style="list-style-type: none"> Internal problem 	<ul style="list-style-type: none"> Send product for repair
Intermittent DMX Problems	<ul style="list-style-type: none"> Signal cables are not DMX compatible 	<ul style="list-style-type: none"> Replace non DMX cables with true DMX cables
	<ul style="list-style-type: none"> Interference with AC or radio signals 	<ul style="list-style-type: none"> Keep DMX cables away from AC wires or radio equipment
	<ul style="list-style-type: none"> DMX cable too long 	<ul style="list-style-type: none"> Install an optically coupled DMX amplifier right before the product with intermittent problems
	<ul style="list-style-type: none"> Too many products connected 	<ul style="list-style-type: none"> Install an optically coupled DMX amplifier after unit #32
	<ul style="list-style-type: none"> Terminator not connected 	<ul style="list-style-type: none"> Install a terminator, as indicated in the <i>DMX Primer</i> section.



If you still experience problems after trying the above solutions, contact CHAUVET® Technical Support.

Contact Procedure

In case you need to return a product or request support, follow the procedure below:

- If you live in the US, contact CHAUVET® World Headquarters (see below).
- If you live in the UK or Ireland, contact CHAUVET® Europe Ltd.(see below).
- If you live in any other country, DO NOT contact CHAUVET®. Instead, contact your distributor of record. Refer to our Web site for contact details of distributors outside the US, United Kingdom, or Ireland.

CHAUVET® Contact Information

World Headquarters

CHAUVET®

General Information

Address: 5200 NW 108th Avenue
Sunrise, FL 33351
Voice: (954) 929-1115
Fax: (954) 929-5560
Toll free: (800) 762-1084

Technical Support

Voice: (954) 929-1115 (Press 4)
Fax: (954) 756-8015
Email: tech@chauvetlighting.com

World Wide Web

www.chauvetlighting.com

United Kingdom & Ireland

CHAUVET® Europe Ltd.

General Information

Address: Unit 1C
Brookhill Road Industrial Estate
Pinxton, Nottingham, UK
NG16 6NT
Voice: +44 (0)1773 511115
Fax: +44 (0)1773 511110

Technical Support

Email: uktech@chauvetlighting.com

World Wide Web

www.chauvetlighting.co.uk



If you live outside the US, United Kingdom, or Ireland, contact your distributor of record and follow their instructions on how to return CHAUVET® products to them. Visit our Web site for contact details.

Returning Products to CHAUVET®

Call the corresponding CHAUVET® Tech Support office and request a Return Merchandise Authorization (RMA) number before shipping the product. Be prepared to provide the model number, serial number, and a brief description of the cause for the return.

You must send the merchandise prepaid, in its original box, and with its original packing and accessories. CHAUVET® will not issue call tags.

Clearly label the package with the RMA number. CHAUVET® will refuse any product returned without an RMA number.



Write the RMA number on a properly affixed label. DO NOT write the RMA number directly on the box.

Before sending the product, clearly write the following information on a piece of paper and place it inside the box:

- Your name
- Your address
- Your phone number
- The RMA number
- A brief description of the problem

Be sure to pack the product properly. Any shipping damage resulting from inadequate packaging will be your responsibility. As a suggestion, proper UPS packing or double-boxing is always a safe method to use.



CHAUVET® reserves the right to use its own discretion to repair or replace returned product(s).

DMX PRIMER

Introduction

The DMX protocol (USITT DMX512-A) is a networking protocol that enables a universal DMX controller device to control the features of multiple DMX compatible fixtures, whether PAR cans, wash lights, moving heads, followspots, foggers, or proprietary fixture controllers, etc.

As any other networking protocol, the USITT DMX512-A describes the physical medium, the signals, and the functions they control.

The Physical Medium

DMX compatible fixtures are connected to the DMX controller using a DMX connection. This connection consists of a series of wired connections between the DMX controller and the various DMX compatible fixtures, also known as a daisy chain connection. In this type of connection, the DATA OUT of one fixture or the DMX controller connects to the DATA IN of the next fixture, and so on.

Each DMX fixture links to the previous and next DMX fixture or controller using a DMX cable. This type of cable consists of a section of shielded, two-conductor twisted pair cable with one 3-pin or 5-pin XLR male connector on one end, and a 3-pin or 5-pin XLR female connector on the other end. The XLR connectors pin-out is as follows: pin 1 is the *Common* (shield), pin 2 is *Signal Negative* (S-), and pin 3 is *Signal Positive* (S+).

Note: For DMX, pins 4 and 5 are not used.

The Signals

The DMX signal stream is unidirectional from the DMX controller to the DMX compatible fixtures. These signals conform to the EIA-485 standard.

The stream of DMX signals consists of 512 individual, sequential channels that form a frame. The DMX controller constantly sends frames of DMX signals to the DMX connection, even if not all of the 512 channels are in use.

Because of this constant transmission method, there can be only one DMX controller in a DMX connection. If not, the DMX signals sent by one controller would interfere with the signals sent by the other controller(s).

DMX Universes

A DMX universe is the set of DMX compatible fixtures connected to the same DMX daisy chain using the same set of 512 DMX channels. Each set of 512 channels is referred to as a DMX Universe.

In most cases, an installation will consist of only one DMX universe. However, you might find it necessary to define two or more universes because of constraints imposed by distance or the number of features.

Most DMX controllers support only one universe, although some DMX controllers may support two or more universes. Each universe will have its own separated DMX daisy chain. A DMX compatible fixture can only be part of a single DMX universe.

The Functions

Each DMX channel can have any unitary value in the 000~255 range. Each DMX compatible fixture uses as many consecutive DMX channels as features the user can control. The sequential numbers assigned to each DMX channel (1~512) are also known as DMX addresses.

The function each DMX channel has, and the results of assigning a value to each depend on the personality (or DMX channel layout) of each controlled fixture. Some fixtures only use a single DMX channel, while others may require 15 or more DMX channels to control all their functions. Personalities are discussed in the next section, *DMX Configuration*.

DMX Configuration

The DMX fixture configuration consists in determining how many channels each fixture will need as well as assigning the corresponding DMX channels to each fixture in order to size correctly the DMX controller.

Personalities

A DMX personality describes what channel or channels control which fixture parameters. A DMX fixture may have many personalities to choose from. Each personality requires a different number of channels, based on the number of features the fixture enables. The number of DMX channels used by a fixture may vary from only one (usually the general dimmer control) to 15 or more.

When a job does not require using all the fixture's capabilities, the user can select a more basic personality (less channels), allowing the DMX controller to accommodate more DMX fixtures.

Starting Address

For the DMX controller to control each DMX fixture, the user must first configure each fixture's personality to determine the number of channels required to control the fixture. Each channel will have a DMX address assigned to it.

However, since assigning a particular DMX address to each channel is impractical, the user will only need to configure the DMX address on each fixture that corresponds to the fixture's first channel of control. This is the fixture's starting address. The fixture will automatically assign the other channels to the subsequent DMX addresses.

Once this assignment is complete, and based on the number of channels used, the fixture will respond to the DMX signals sent to the range of DMX channels that begins with the starting address.

For example, a fixture that uses six DMX channels with a starting address of 100, will accept DMX data sent by the DMX controller to channels 100, 101, 102, 103, 104, and 105.

Assigning Addresses

The user must carefully assign the starting addresses for each individual fixture to avoid DMX channel overlapping. If the DMX channels do overlap, the impacted fixtures could operate erratically.

However, the user may decide to configure two or more similar fixtures with the same personality and starting address. In this case, all the fixtures with the same starting address will operate in unison.

DMX Connectivity

Connecting the DMX fixtures to a DMX controller in small to medium installations is usually a rather simple operation that requires a minimum of tools and some planning (not including the actual fixture rigging and configuration).

However, in large installations it may be necessary to plan carefully the position and cabling of each fixture to avoid unexpected problems.

Fixture Location

The order in which the fixtures connect to the DMX controller is not important and has no effect on how a controller communicates to each fixture. However, the user should always define a physical location for the fixtures that provides for the easiest and most direct cabling to the controller and other fixtures.

Number of Fixtures

When using a DMX controller, the combined number of channels required by all the fixtures on the DMX daisy chain determines the number of fixtures the DMX controller has to support. Conversely, the number of onboard sliders, page buttons, and fixture buttons limits the number of discrete DMX channels a DMX controller can support.



To comply with the EIA-485 standard, which is the base for the USITT DMX512-A protocol, do not connect more than 32 fixtures without using an optically-isolated DMX splitter. Doing otherwise may result in deterioration of the digital DMX signal.

DMX Data Cabling

You must use DMX compliant data cables to link two or more DMX compatible fixtures. You may purchase CHAUVET® certified DMX cables directly from a dealer/distributor or construct your own cable.



USITT recommends limiting the total length of the DMX cable (from the first fixture/controller to the last fixture) to 300~455 m (985~1,500 ft).

Making Your Own DMX Cable

If you choose to create your own DMX cable, make sure to use data-grade cables that can carry a high frequency signal and are less prone to electromagnetic interference. Use a Belden® 9841 or equivalent cable, which meets the specifications for EIA RS-485 applications. For certain applications, Cat5, Cat5e, or Cat6 may be appropriate.



Do not use standard microphone cables for DMX applications because they cannot transmit DMX data reliably over long distances.

DMX Cable Characteristics

The DMX data cable must have the following characteristics:

Type:	shielded, 2-conductor twisted pair
Maximum capacitance between conductors:	30 pF/ft
Maximum capacitance between conductor and shield:	55 pF/ft
Maximum resistance:	20 ohms/1000 ft
Nominal impedance:	100~140 ohms

DMX Cable Connectors

Each DMX cable must have a male (3-pin or 5-pin XLR connector) on one end and a female (3-pin or 5-pin XLR connector) on the other end.

DMX Connector Configuration

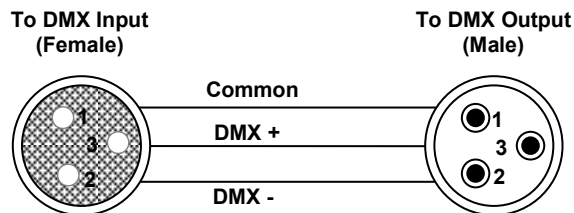

To avoid signal transmission problems and interference, connect a DMX signal terminator to the last fixture in the DMX daisy chain, as shown.

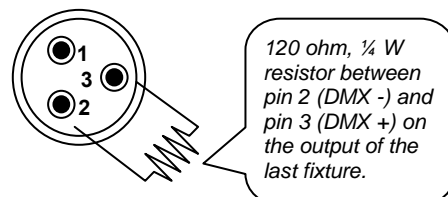



Test all DMX cables with an ohmmeter to verify their correct polarity and to make sure that there are no short-circuits between any of the pins, or between any pin and ground.

If the common wire (shield) touched the chassis ground, a ground loop could form, which may cause the fixture to perform erratically.

3-Pin to 5-Pin Conversion Chart

If you use a DMX controller or fixture with a 5-pin DMX connector, you will need to use a 5-pin to 3-pin adapter. The chart below details a proper cable conversion.

3-Pin to 5-Pin Conversion Chart

Conductor	3-Pin Female (Output)	5-Pin Male (Input)
Ground/Shield	Pin 1	Pin 1
Negative (-) signal	Pin 2	Pin 2
Positive (+) signal	Pin 3	Pin 3
Not Used		Pin 4
Not Used		Pin 5

DMX Connection

Make sure that the fixtures with which you are working can operate in DMX mode, not in a proprietary connection mode. Refer to the fixtures' manual to learn how to enable their respective DMX modes.

The procedure below illustrates a possible DMX connection method.

1. Connect the 3-pin, male connector of the first DMX cable to the DMX Output connector (3-pin, female) of the DMX controller.
2. Connect the 3-pin, female connector of the first DMX cable coming from the controller to the DMX Input connector (3-pin, male) of the first DMX fixture.
3. Connect the 3-pin, male connector of the second DMX cable to the DMX Output connector (3-pin, female) of the first DMX fixture.
4. Connect the 3-pin, female connector of the second DMX cable coming from the first DMX fixture to the DMX Input connector of the second DMX compatible fixture.
5. Continue linking the other DMX fixtures in the same way.

6. TECHNICAL SPECIFICATIONS

Dimensions and Weight	Length	Width	Height	Weight
	16.7 in (424 mm)	6.4 in (164 mm)	8.8 in (224 mm)	10.6 lbs (4.8 kg)

Note: Dimensions in inches rounded to the nearest decimal digit.

Power	Power Supply Type	Range	Voltage Selection
	Switching (internal)	100~240 V, 50/60 Hz	Auto-ranging

	Parameter	120 V, 60 Hz	230 V, 50 Hz
	Consumption	237 W	235 W
	Operating	1.9 A	1 A
	Power linking current (units)	8 A (5 units)	8 A (10 units)
	Fuse	F 5 A, 250 V	F 5 A, 250 V

	Power I/O	US/Worldwide	UK/Europe
	Power input connector	IEC	IEC
	Power output connector	Edison	IEC
	Power Cord plug	Edison (US)	Local plug

Light Source	Type	Lifespan
	LED	50,000 hours

	Color	Quantity	Current
	White	648	60 mA

Photo Optic	Parameter	
	Strobe Rate	0-30 Hz
	Illuminance @ 2 m	909 lux
	Beam angle	66°
	Field angle	105°
	Viewing angle	120°
	Color Temperature	6500-7000 K

Thermal	Maximum External Temp.	Cooling System
	104° F (40° C)	Convection

DMX	I/O Connectors	Connector Type	Channel Range
	3- and 5-pin XLR	Sockets	2

Ordering	Product Name	Item Code	Item Number
	Impulse™ 648	03050457	IMPULSE648