



# FSD-100

## Smoke Detector Sensitivity Meter

### *User Guide*



Warning: This document contains information on limitations regarding product use and function and information on the limitations as to liability of the manufacturer. Read the entire manually carefully.



# TABLE OF CONTENTS

<b>1</b>	<b>Introduction</b> . . . . .	<b>1</b>
1.1	Out of the Box . . . . .	2
1.2	Battery Installation . . . . .	2
1.3	Controls & Indicators . . . . .	3
<b>2</b>	<b>Operation</b> . . . . .	<b>4</b>
2.1	Power Up / Power Down . . . . .	4
2.2	Smoke Detector Testing . . . . .	6
2.3	Viewing Test Records. . . . .	7
2.4	Downloading Test Records . . . . .	8
2.5	Checking Tester Status . . . . .	9
<b>APP A</b>	<b>Status &amp; Troubles</b> . . . . .	<b>11</b>
<b>APP B</b>	<b>Sensitivity Measurement Conversion</b> . . . . .	<b>11</b>



# 1 Introduction

The FSD-100 Smoke Detector Sensitivity Meter is intended for comprehensive in-place-testing of the WS-4916, FSA210 and FSA410 Series Smoke Detectors. The meter is hand held and battery operated, providing 20 hours of continuous operation and stores up to 500 detector tests.

## ***Features:***

- 9 Volt alkaline battery provides 20 Hrs (minimum) operation
- Internal battery check displays remaining battery capacity.
- Battery Reverse Polarity Protection.
- Automatic shutdown 4 minutes after last key press.
- All features are accessed using 4 pushbuttons
- Storage and retrieval of up to 500 detector tests.
- Records stored in non-volatile memory
- Downloads records to PC using MicroSoft® HyperTerminal® software
- Records Date, Time, Model and Version, Date of Manufacture, and Serial Number for all tests.

## ***Detector Troubles***

Smoke, low sensitivity  
Smoke, high sensitivity  
Smoke sensor fault  
Heat sensor fault  
Measurement errors  
Memory errors  
Trouble already transmitted

## ***Detector Status***

Tampers  
Smoke Alarm  
Smoke Sensor Trouble/fault  
Low Battery (Smoke Detector)  
Heat Alarm  
Heat sensor fault  
Cold temperature warning

## 1.1 Out of the Box

The FSD-100 tester includes the following:

- 1 FSD 100 Smoke Detector Sensitivity Meter
- 1 Duracell® Procell® PC1604 Alkaline 9VDC Battery
- 1 PC-Link Local Download KIT-DB09.
- 1 Download kit adaptor
- 1 *User Guide*
- 1 *Quick Reference Guide*

## 1.2 Battery Installation:

The FSD-100 is shipped with a battery

1. Remove the rear cover
2. Remove the battery from the battery compartment.
3. Remove the plastic protection from the battery terminals.
4. Insert battery as indicated in the battery compartment.

**Figure 1 - Battery Replacement**

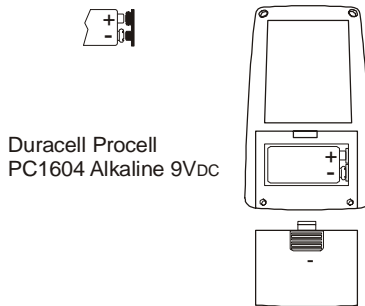

**NOTES:** Replace battery with Duracell® Procell® PC1604 Alkaline 9VDC Battery. Incorrect placement of the battery will NOT damage the unit. Removal and replacement of battery will NOT delete stored records. You will be prompted to set date and time on first power up following battery replacement.

### 1.3 Controls and Indicators:

The FSD-100 displays all information on a 32 character LCD. A PC LINK connection is located on the right side of the unit for downloading data to a PC.

The use of the <, >, \*, and # keys varies depending on the screen you are currently in. Use of these keys is indicated on each screen. The list below indicates the general use of these keys.

- > Used to Scroll forward through menu selections from the Ready Mode. Moves cursor to the right in time and date programming.
  
- < Used to Scroll back through menu selections from the Ready Mode. Moves cursor to the left in time and date programming.
  
- \* Advances to next option within a menu sequence.  
Initiates Testing and Downloading.  
Increments value selected with < and > keys in time and date programming.  
Turns off device during power down.
  
- # Exits a menu selection.

## 2 Operation:

### 2.1 Power Up/Power Down

#### **Powering Up:**

On power up the model name and version of the tester is displayed on the top line, remaining battery capacity is displayed on the second line.

**Note:** 99% indicates that the battery is fully charged.  
Replace battery when 1% is indicated.

This screen will be displayed for 2 seconds.

```
FSD-100 V1.00  
BATTERY LIFE=99%
```

#### **Record Capacity:**

Indicates the current number of tests stored in the tester out of a maximum of 500 tests.

This screen will be displayed for 2 seconds.

```
RECORD CAPACITY:  
300/500 FILLED
```

#### **Time & Date Trouble:**

This screen will only be displayed if time and date are unprogrammed (e.g., at first power up or after battery replacement).

```
TIME & DATE TRBL  
PRESS * TO PROG.
```

Press # to save date and time programming and advance to the next screen.

#### **Ready Screen:**

This screen is displayed 2 seconds after the **Record Capacity** screen is displayed or after exiting **Date and Time** programming.

This screen allows you to scroll through the 6 menu options available on the tester.



## Powering Down:

The tester can be powered down in two ways:

- (1) The unit will automatically power down 4 minutes after the last keypress regardless of the screen it is currently in.
- (2) Pressing the scroll key  $\rightarrow$  5 times from the Ready mode screen will display the "Press \* for Power Down" screen. Press the \* key twice to power down or press # to return to the Ready screen.

Figure 2 - Power Up and Main Flow Menu

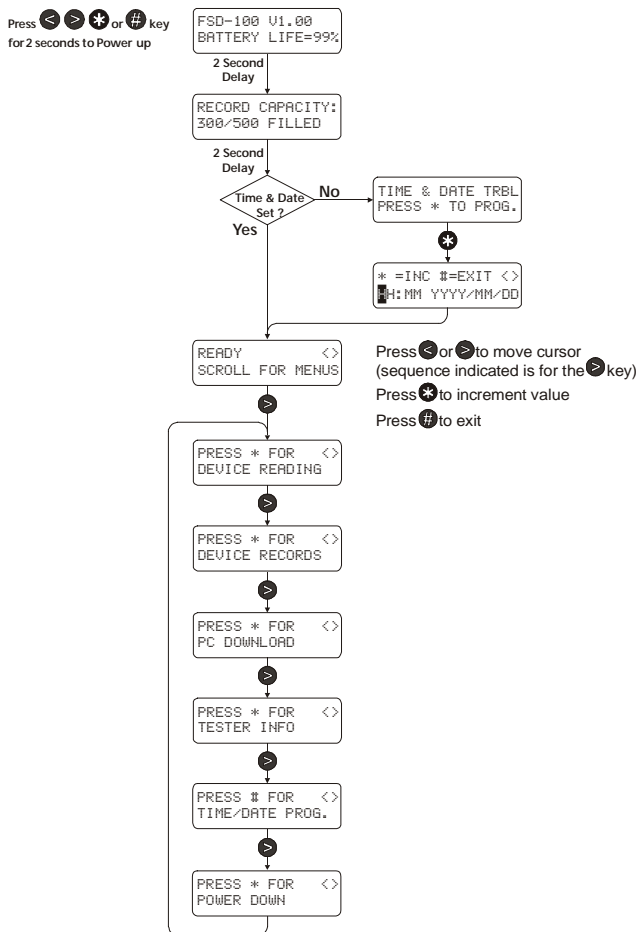

**Note:** Pressing the  $\rightarrow$  key will scroll through the menu in the sequence indicated. To scroll in the reverse direction use the  $\leftarrow$  key.

## 2.2 Smoke Detector Testing

- (1) Follow the steps indicated in figure 3 until the **TRIGGER DEVICE WAIT FOR BEEP** screen appears.
- (2) Press the LED/Test Button located on the smoke detector with the tester.
- (3) Position the tester less than 2.5 cm (1 Inch) from the center dome of the smoke detector.

The Smoke Detector and the FSD-100 Tester will indicate that data is being transmitted and received by sounding a series beeps from each device.

When data transmission is completed, the beeping will stop and the FSD-100 tester will display the **TEST COMPLETE ! DATA SAVED** screen followed by a 2 second delay.

- (4) After the delay the **PRESS \* FOR DATA REVIEW** screen will appear.
  - (a) Pressing \* will begin the test review (See Paragraph) 2.3 *Viewing Test Records*.
  - (b) Pressing the < or > keys will return you to the **TESTER READY** screen.

Figure 3 - Testing

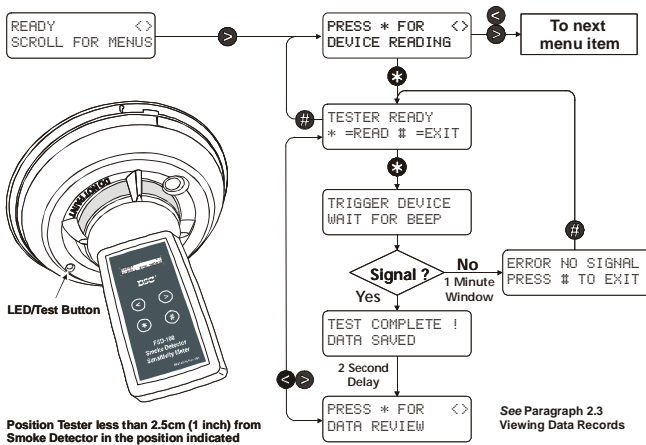

## 2.3 Viewing Test Records

The Test Records section can be entered directly after a Smoke Detector Test when the **PRESS \* FOR DATA REVIEW** screen appears. This option allows you to review the preceding test only.

Test records can be reviewed by following the steps indicated in figure 4.

**Figure 4 - Viewing Test Records**

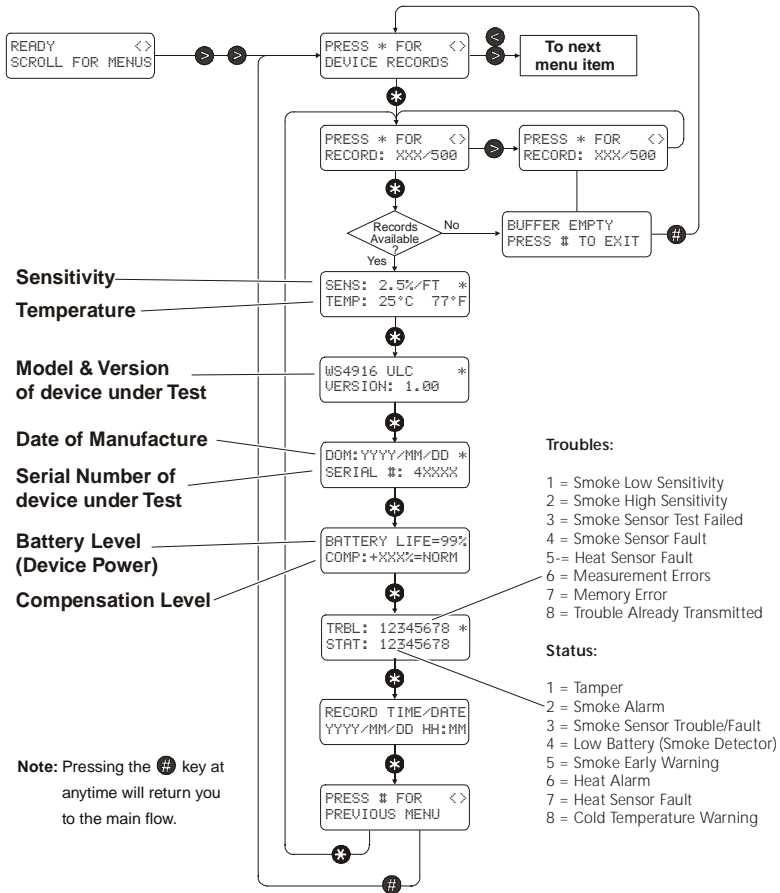

## 2.4 Downloading Test Records

- (1) Scroll to the "PRESS \* FOR DOWNLOAD" screen.
- (2) Connect the Tester to the Personal Computer.

**Figure 5 - Tester Setup**

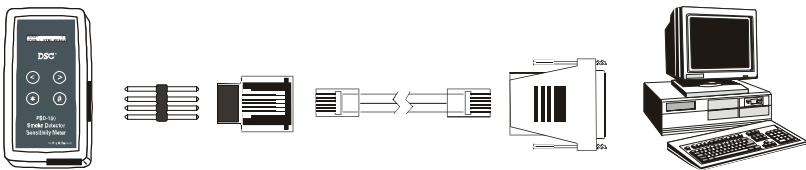

**NOTE:** A DB09 to DB25 adaptor may be required for some computer configurations

- (3) Open Microsoft® HyperTerminal® or equivalent.  
Configure the Serial COM Port as follows:
  - Set Baud Rate to 9600
  - Set Bits to 8
  - Set Parity to None
  - Set Stop Bits to 1
- (4) Press \* to initiate downloading.
- (5) When downloading is complete, a beep will be sounded and you will be prompted to delete the tester records.
- (6) Save File - The saved file can be exported to another program such as Microsoft® Excel®. See Program User Manual or Help File.

**Figure 6 - Downloading**

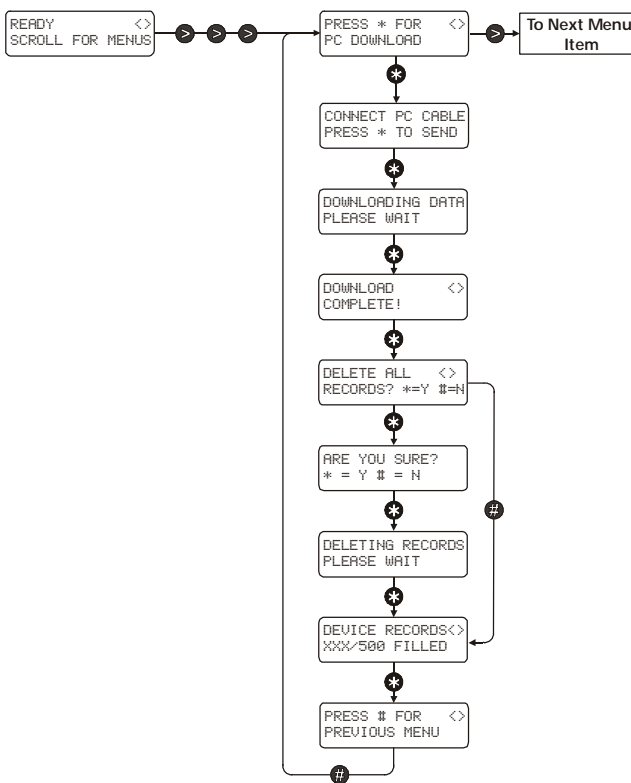

## 2.5 Checking Tester Status

Battery life, number of records stored, date & time programming and powering down can all be accessed from this screen.

Figure 7 - Checking Tester Status

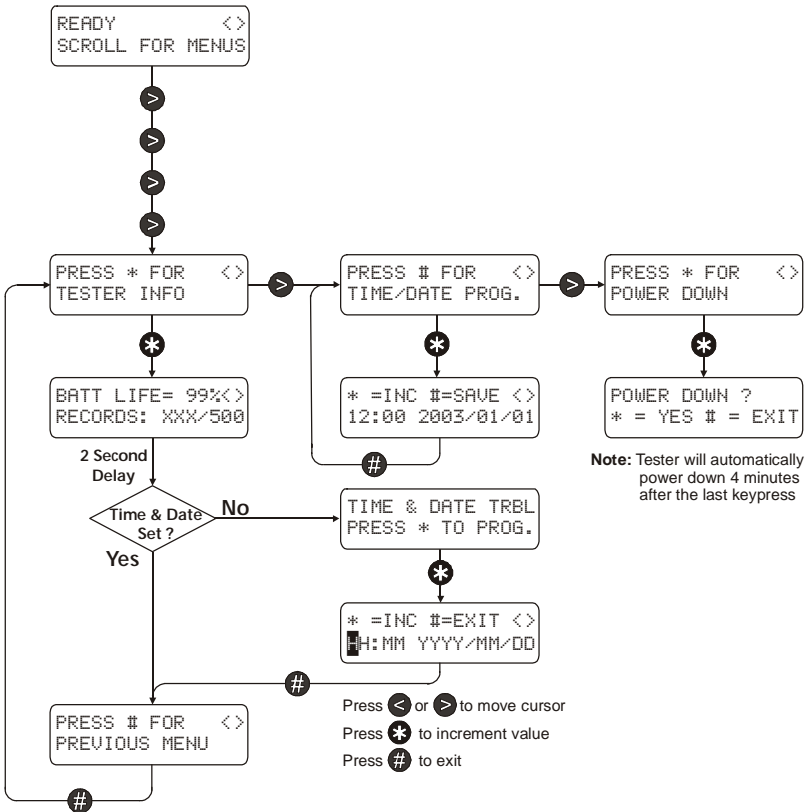



## Appendix A: Status and Troubles

The following table lists the Troubles and Status Readings found in the Trouble Status screen

TRBL: 12345678 *
STAT: 12345678

Troubles	Status
1 Smoke Low Sensitivity	1 Tamper
2 Smoke High Sensitivity	2 For Factory Use
3 Smoke Sensor Test Failed	3 Smoke Sensor Trouble/Fault
4 Smoke Sensor Fault	4 Low Battery
5 Heat Sensor Fault	5 Smoke Early Warning
6 Measurement Errors	6 For Factory Use
7 Memory Error	7 Heat Sensor
8 Trouble Already Transmitted	8 Cold Temperature Warning

## Appendix B: Sensitivity Measurement Conversion

The following table converts sensitivity measurements in % obscuration per foot (NA) to the approximate measurement in dBm (EU)

Sensitivity %/ft	Sensitivity dBm
0.25	0.036
0.50	0.071
0.75	0.107
1.00	0.143
1.25	0.179
1.50	0.215
1.75	0.252
2.00	0.288
2.25	0.324
2.50	0.361
2.75	0.397
3.00	0.434
3.25	0.471
3.50	0.508
3.75	0.545
4.00	0.582
4.25	0.619
4.50	0.656
4.75	0.693
5.00	0.731

## Limited Warranty

Digital Security Controls Ltd. warrants that for a period of twelve months from the date of purchase, the product shall be free of defects in materials and workmanship under normal use and that in fulfillment of any breach of such warranty, Digital Security Controls Ltd. shall, at its option, repair or replace the defective equipment upon return of the equipment to its repair depot. This warranty applies only to defects in parts and workmanship and not to damage incurred in shipping or handling, or damage due to causes beyond the control of Digital Security Controls Ltd. such as lightning, excessive voltage, mechanical shock, water damage, or damage arising out of abuse, alteration or improper application of the equipment.

The foregoing warranty shall apply only to the original buyer, and is and shall be in lieu of any and all other warranties, whether expressed or implied and of all other obligations or liabilities on the part of Digital Security Controls Ltd. Digital Security Controls Ltd. neither assumes, responsibility nor authorizes any other person purporting to act on its behalf to modify or to change this warranty, nor to assume for it any other warranty or liability concerning this product.

In no event shall Digital Security Controls Ltd. be liable for any direct, indirect or consequential damages, loss of anticipated profits, loss of time or any other losses incurred by the buyer in connection with the purchase, installation or operation or failure of this product.

### Smoke Detectors

Smoke detectors that are a part of this system may not properly alert occupants of a fire for a number of reasons, some of which follow. The smoke detectors may have been improperly installed or positioned. Smoke may not be able to reach the smoke detectors, such as when the fire is in a chimney, walls or roofs, or on the other side of closed doors. Smoke detectors may not detect smoke from fires on another level of the residence or building.

Every fire is different in the amount of smoke produced and the rate of burning. Smoke detectors cannot sense all types of fires equally well. Smoke detectors may not provide timely warning of fires caused by carelessness or safety hazards such as smoking in bed, violent explosions, escaping gas, improper storage of flammable materials, overloaded electrical circuits, children playing with matches or arson.

Even if the smoke detector operates as intended, there may be circumstances when there is insufficient warning to allow all occupants to escape in time to avoid injury or death.

*Warning: Digital Security Controls Ltd. recommends that the entire system be completely tested on a regular basis. However, despite frequent testing, and due to, but not limited to, criminal tampering or electrical disruption, it is possible for this product to fail to perform as expected.*

*Important Information: Changes or modifications not expressly approved by Digital Security Controls Ltd. could void the user's authority to operate this equipment.*

## FCC Compliance Statement

**CAUTION: Changes or modifications not expressly approved by DSC could void your authority to use this equipment.**

This equipment has been tested and found to comply with the limits for a Class B digital device, pursuant to Part 15 of the FCC Rules. These limits are designed to provide reasonable protection against harmful interference in a residential installation. This equipment generates, uses and can radiate radio frequency energy and, if not installed and used in accordance with the instructions, may cause harmful interference to radio communications. However, there is no guarantee that interference will not occur in a particular installation. If this equipment does cause harmful interference to radio or television reception, which can be determined by turning the equipment off and on, the user is encouraged to try to correct the interference by one or more of the following measures:

- Re-orient the receiving antenna.
- Increase the separation between the equipment and receiver.
- Connect the equipment into an outlet on a circuit different from that to which the receiver is connected.
- Consult the dealer or an experienced radio/television technician for help.

The user may find the following booklet prepared by the FCC useful: "How to Identify and Resolve Radio/Television Interference Problems". This booklet is available from the U.S. Government Printing Office, Washington D.C. 20402, Stock # 004-000-00345-4.

## Industry Canada Compliance Statement

This Class B digital apparatus meets all requirements of the Canadian interference-causing equipment regulations. Cet appareil numérique de la Classe B respecte toutes les exigences de règlement sur le matériel brouilleur du Canada.



©2003 Digital Security Controls  
Toronto • Canada • 1-800-387-3630  
[www.dsc.com](http://www.dsc.com) Printed in Canada  
Forward comments about this manual to:  
[pubs@dsc.com](mailto:pubs@dsc.com)



29034666R001