



## LCD Television Users Guide

**LT-42X899**

**LT-47X899**

1080p HDTV

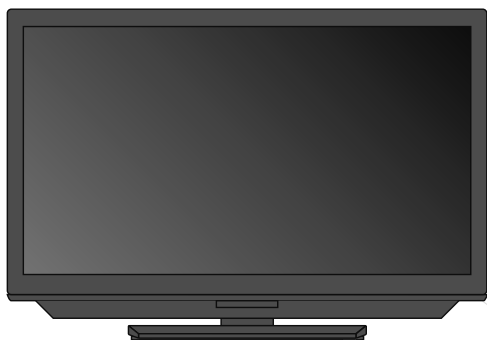

### **Important Note:**

In the spaces below, enter the model and serial number of your television (located at the rear of the television cabinet). Staple your sales receipt or invoice to the inside cover of this guide. Keep this user's guide in a convenient place for future reference. Keep the carton and original packaging for future use.

**Serial Number:** \_\_\_\_\_

**Model Number:** \_\_\_\_\_

LCT2403-001A-A  
0508TSH-II-IM

# Table of Contents

<b>Warnings</b> . . . . .	<b>3</b>	<b>Picture Adjust</b> . . . . .	<b>34</b>
<b>Precautions</b> . . . . .	<b>7</b>	Video Status . . . . .	34
<b>Remote Control</b> . . . . .	<b>10</b>	Natural Cinema . . . . .	35
<b>TV Basic Controls</b> . . . . .	<b>12</b>	Theater Pro II . . . . .	35
<b>Key Features</b> . . . . .	<b>17</b>	x.v.Color . . . . .	35
<b>Setup</b> . . . . .	<b>18</b>	Color Temp . . . . .	35
Interactive Plug-In Menu . . . . .	18	Color Management . . . . .	36
<b>Remote Control Functions</b> . . . . .	<b>20</b>	Dynamic Gamma . . . . .	36
Return+ TV . . . . .	20	Smart Picture . . . . .	36
Favorite . . . . .	20	Digital VNR . . . . .	36
Aspect . . . . .	20	MPEG NR . . . . .	36
Sound . . . . .	21	Smart Sensor . . . . .	36
Video . . . . .	21	Reset . . . . .	36
Guide . . . . .	21	<b>Sound Adjust</b> . . . . .	<b>37</b>
SUB CH . . . . .	21	Balance . . . . .	37
C.C. . . . .	22	Turn On Volume . . . . .	37
TWIN . . . . .	22	Volume Limit . . . . .	37
Sleep . . . . .	23	Optical Out . . . . .	38
ML/MTS . . . . .	23	Reset . . . . .	38
SWAP . . . . .	23	<b>Features</b> . . . . .	<b>39</b>
SELECT . . . . .	23	Video-5 Input . . . . .	39
<b>Customizing your TV</b> . . . . .	<b>24</b>	Noise Muting . . . . .	39
<b>Initial Setup</b> . . . . .	<b>25</b>	Front Panel Lock . . . . .	39
Language . . . . .	25	Auto Shut Off . . . . .	39
Tuner Setup . . . . .	25	Quick Start-up . . . . .	39
Set Clock . . . . .	26	Aspect . . . . .	40
Set Lock Code . . . . .	27	Position Adjustment . . . . .	41
Interactive Plug-in Menu . . . . .	27	Illumination . . . . .	41
Software Version . . . . .	27	Power indicator . . . . .	41
Auto Demo . . . . .	27	HDMI Size . . . . .	41
<b>V-Chip</b> . . . . .	<b>28</b>	Control with HDMI . . . . .	42
V-Chip . . . . .	29	Video-1 Audio . . . . .	42
Set US TV Ratings . . . . .	29	Video Input Label . . . . .	42
Set Movie Ratings . . . . .	30	<b>Key Items</b> . . . . .	<b>43</b>
Set Canadian Ratings English . . . . .	31	Favorite . . . . .	43
Set Canadian Ratings French . . . . .	31	Guide . . . . .	43
Unrated . . . . .	31	Display . . . . .	43
<b>Closed Caption</b> . . . . .	<b>32</b>	Sleep Timer . . . . .	43
Closed Caption . . . . .	32	Multi Language/MTS . . . . .	44
Reset . . . . .	32	<b>Photo Viewer</b> . . . . .	<b>45</b>
<b>On/Off Timer</b> . . . . .	<b>33</b>	<b>Connecting Your Devices</b> . . . . .	<b>48</b>
Mode . . . . .	33	<b>Programming Your Remote</b> . . . . .	<b>55</b>
On Time . . . . .	33	<b>Troubleshooting</b> . . . . .	<b>62</b>
Off Time . . . . .	33	<b>Specifications</b> . . . . .	<b>64</b>
Channel . . . . .	33	<b>Warranty</b> . . . . .	<b>65</b>
On Volume . . . . .	33	<b>Notes</b> . . . . .	<b>67</b>

# Warnings



**CAUTION**  
**RISK OF ELECTRIC SHOCK**  
**DO NOT OPEN**

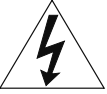

**CAUTION:** To reduce the risk of electric shock. Do not remove cover (or back). No user serviceable parts inside. Refer servicing to qualified service personnel.

 The lightning flash with arrowhead symbol, within an equilateral triangle is intended to alert the user to the presence of uninsulated “dangerous voltage” within the product’s enclosure that may be of sufficient magnitude to constitute a risk of electric shock to persons.

 The exclamation point within an equilateral triangle is intended to alert the user to the presence of important operating and maintenance (servicing) instructions in the literature accompanying the appliance.

**WARNING:** TO PREVENT FIRE OR SHOCK HAZARDS, DO NOT EXPOSE THIS APPARATUS TO RAIN OR MOISTURE.

**CAUTION:** TO INSURE PERSONAL SAFETY, OBSERVE THE FOLLOWING RULES REGARDING THE USE OF THIS UNIT.

1. Operate only from the power source specified on the unit.
2. Avoid damaging the AC plug and power cord.
3. Avoid improper installation and never position the unit where good ventilation is unattainable.
4. Do not allow objects or liquid into the cabinet openings.
5. In the event of trouble, unplug the unit and call a service technician. Do not attempt to repair it yourself or remove the rear cover.

Changes or modifications not approved by JVC could void the warranty.

- \* When you don't use this TV set for a long period of time, be sure to disconnect both the power plug from the AC outlet and antenna for your safety.
- \* To prevent electric shock do not use this polarized plug with an extension cord, receptacle or other outlet unless the blades can be fully inserted to prevent blade exposure.



- As an “ENERGY STAR®” partner, JVC has determined that this product or product model meets the “ENERGY STAR®” guidelines for energy efficiency.

# Warnings

## IMPORTANT RECYCLING INFORMATION

This product has a fluorescent lamp that contains mercury. Disposal of these materials may be regulated in your community due to environmental considerations. For disposal or recycling information, please contact your local authorities or for USA, the Electronic Industries Alliance: <http://www.eiae.org>

## IMPORTANT SAFETY INSTRUCTIONS

- 1) Read these instructions.
- 2) Keep these instructions.
- 3) Heed all warnings.
- 4) Follow all instructions.
- 5) Do not use this apparatus near water.
- 6) Clean only with dry cloth.
- 7) Do not block any ventilation openings. Install in accordance with the manufacturer's instructions.
- 8) Do not install near any heat sources such as radiators, heat registers, stoves, or other apparatus (including amplifiers) that produce heat.
- 9) Do not defeat the safety purpose of the polarized or grounding-type plug. A polarized plug has two blades with one wider than the other. A grounding type plug has two blades and a third grounding prong. The wide blade or the third prong are provided for your safety. If the provided plug does not fit into your outlet, consult an electrician for replacement of the obsolete outlet.
- 10) Protect the power cord from being walked on or pinched particularly at plugs, convenience receptacles, and the point where they exit from the apparatus.
- 11) Only use attachments/accessories specified by the manufacturer.
- 12) Use only with a cart, stand, tripod, bracket, or table specified by the manufacturer, or sold with the apparatus. When a cart is used, use caution when moving the cart/apparatus combination to avoid injury from tip-over.
- 13) Unplug this apparatus during lightning storms or when unused for long periods of time.
- 14) Refer all servicing to qualified service personnel. Servicing is required when the apparatus has been damaged in any way, such as power-supply cord or plug is damaged, liquid has been spilled or objects have fallen into the apparatus, the apparatus has been exposed to rain or moisture, does not operate normally, or has been dropped.
- 15) Apparatus shall not be exposed to dripping or splashing and no objects filled with liquids, such as vases, shall be placed on the apparatus.



# Warnings

- 16) Place the television on a stable, flat surface. Failure to do so can result in the television falling, causing injury.
- 17) **DO NOT** allow young children to play around or on the television. Do not hang from the TV. Failure to do so can result in the television falling, causing injury.
- 18) **DO NOT** allow young children to play with the plastic bag that came with the television when you unpacked it. Failure to do so can result in suffocation, causing injury.
- 19) Avoid improper installation and never position the unit where good ventilation is impossible. When installing this TV, distance recommendations must be maintained between the set and the wall, as well as inside a tightly enclosed area or piece of furniture. Keep to the minimum distance guidelines shown for safe operation.

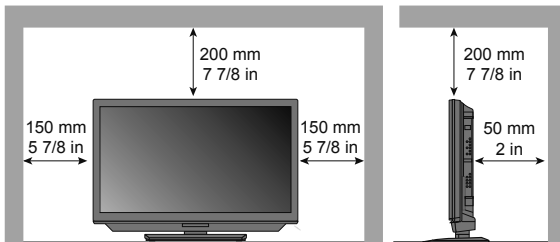

## 20) Cautions for installation

- Do not tilt the TV towards the left or right, or towards the back.
- Install the TV in a corner on the floor so as to keep cords out of the way.
- The TV will generate a slight amount of heat during operation. Ensure that sufficient space is available around the TV to allow satisfactory cooling.
- Have two people remove the TV from the box with the screen facing away from you. It's possible your clothing, (such as a belt buckle or button) may scratch the front of the TV. Do the same when moving the TV to another location.

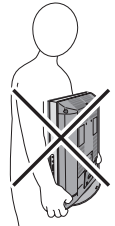

- 21) When attaching to a wall, use the optional JVC wall mounting unit.

For LT-42X899: JVC-XUF-2637 LCD FLAT WALL MOUNT

For LT-47X899: JVCPCM-MS2 TILT/FLAT WALL MOUNT

### Caution

- Consult qualified installers.
  - See the included manual on mounting procedures.
  - JVC is not responsible for damages or injuries due to improper mounting.
  - Use with other wall mounting unit is capable of resulting in instability or causing possible injury.
- 22) Make enough room for inserting and removing the power plug. Place the TV as close to the outlet as possible. The main power supply for this TV is controlled by inserting or removing the power plug.
  - 23) Batteries shall not be exposed to excessive heat such as sunshine, fire or the like.
  - 24) When this TV is connected to the wall outlet, it is always on standby even when all the LED lamps are not lit. To shut down the TV, unplug the TV from the wall outlet.

# Warnings

**FCC Notice:**

**Caution:** Changes or modifications not expressly approved by party responsible for compliance could void the user's authority to operate the equipment.

**Note:** This equipment has been tested and found to comply with the limits for a Class B digital device, pursuant to Part 15 of the FCC Rules. These limits are designed to provide reasonable protection against harmful interference in a residential installation. This equipment generates, uses and can radiate radio frequency energy and, if not installed and used in accordance with the instructions, may cause harmful interference to radio communications. However, there is no guarantee that interference will not occur in a particular installation. If this equipment does cause harmful interference to radio or television reception, which can be determined by turning the equipment off and on, the user is encouraged to try to correct the interference by one or more of the following measures:

- Reorient or relocate the receiving antenna.
- Increase the separation between the equipment and receiver.
- Connect the equipment into an outlet on a circuit different from that to which the receiver is connected.
- Consult the dealer or an experienced radio/TV technician for help.

We have an important note for customers who subscribe to basic cable services (do not have a separate cable box) and plan to use their JVC TV remote control to select channels.

Once you run the Auto Tuner Setup (which detects and programs all the channels your TV is receiving through the RF input), every channel number available from your cable company will appear in your television's Channel Summary and they will all be marked as available for scanning. Even though every channel is detected and appears as available, you will only be able to view those that you specifically subscribe to from your cable company. This will likely mean there are blank channels between those channels you wish to scan or "surf".

We apologize for any inconvenience this may cause but it is important to note that this is not a malfunction of your television. If you want to sequentially scan those channels you subscribe to without blank ones in between, you can contact your cable company for their cable box and remote, or manually deselect them using the edit / skip feature on page 25.

# Precautions

## Avoiding Temporary Burn-in

Displaying fixed images for extended periods of time can leave a subtle but temporary burn-in image on your screen. To avoid this, mix your viewing pattern.

Examples include, but are not limited to the following:

- Stock-market report bars
- Shopping channel logos and pricing displays
- Video game patterns or scoreboards
- Bright station logos
- Internet web sites or other computer-style images
- DVD discs, video tapes, laser discs
- Broadcast, cable, satellite channels or digital television tuners/converters

For example...

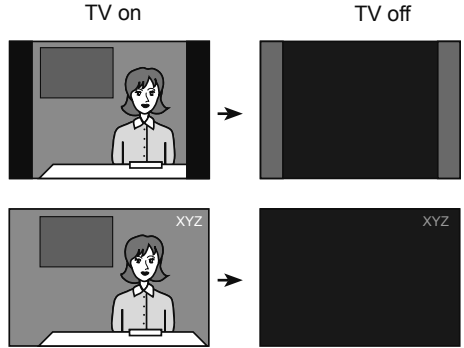

## Caring for the Cabinet

Normally, light dusting with a soft, non-scratching duster will keep your TV clean.

If you wish to wipe down the television, first unplug it. Then wipe gently with a soft cloth, slightly moistened with water. You can add a few drops of mild liquid detergent to the water to help remove spots of oily dirt.

- DO NOT allow liquid to enter the TV through the ventilation slots.
- DO NOT use strong or abrasive cleaners on the TV.
- DO NOT spray liquids or cleaners directly on the TV's surface.
- DO NOT rub or scrub the TV harshly. Wipe the set gently with a soft cloth.

## Caring for the Screen

The screen is treated with an electrostatic-proof coating. When it gets dirty, wipe it gently with a soft cloth. If the screen is very dirty, wipe it down with a cloth dipped in a diluted kitchen cleaner and thoroughly wrung-out. Then wipe immediately after with a clean, dry cloth.

Do not apply alcohol, organic solvents (like acetone), acidic or alkaline cleansers to the screen. These will remove the coating layer and cause discolorations.

Do not push or hit the screen. This could cause scratches on the screen surface and image distortions.

# Precautions

## Tidying the cables

A cable holder which keeps your connection cables tidy is attached to the back of the stand.

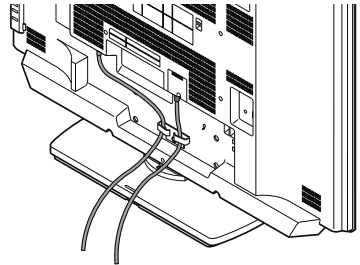

## Install your TV

To prevent the TV from falling, thread the belt through the hole on the back of the stand and secure it to the TV rack.

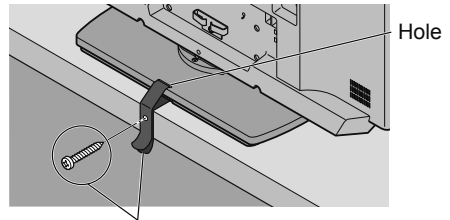

Belt and screw (not included)

## Disconnecting the stand

- 1) Place the TV face down on a soft cloth on a table.
- 2) Remove the five screws from the back of the TV.

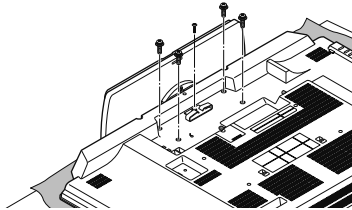

- 3) Pull out the stand from the TV.

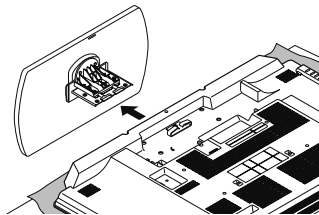

### Note:

- To re-install the stand, reverse the procedure from 3) to 1).



# Precautions

## Package Contents

Make sure you have the following.

Television x 1



Remote Control x 1



AA Batteries x 2



## How to clean the frame and stand

Your TV has a glossy frame and stand which have protection sheets attached to them. Peel them off before use, but only after the TV has been properly placed. Take care with handling the glossy frame and stand because these surfaces are delicate. If the glossy frame or stand becomes dirty, first dust it off, then wipe it softly with a cleaning cloth. If you wipe without dusting off, you may damage it.

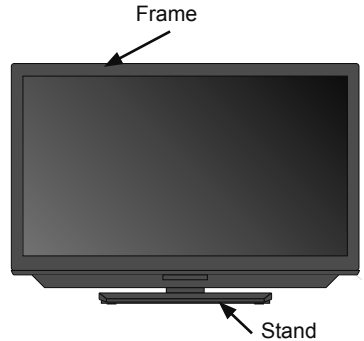

## Insert the batteries

Use two "AA" batteries (included).

Place the "-" end in the unit first, making sure the "+" and "-" markings are correct. Place the "-" end in the unit first.

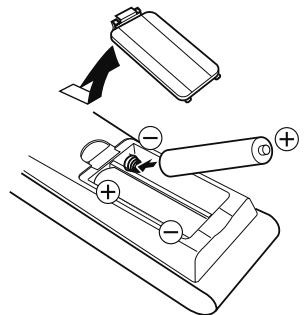

If this symbol is shown, it is only valid in the European Union

# Remote Control

The following pages gives you a brief description of each button's function. For more detailed information on the remote control buttons, see pages 20 - 23. This remote can also control up to four other devices. See page 55 - 61.



Turns the TV on or off.



Switch between "TV / STB / VCR / DVD / AUDIO devices. See page 55.

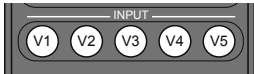

Switch between devices connected to Video-1, 2, 3, 4 and 5.

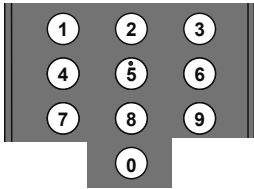

Change channels. Input remote codes. See page 55.



Lets you decide the input channel and select it. After pressing the remote 0 - 9 buttons, press TUNE.



Lets you go back to the previously selected channel. See page 20.

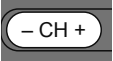

Move sequentially through the channels.



Raise or lower the volume.



All remote control buttons are illuminated, except for the **LIGHT** button.



Turns the TV volume to 0. Press again to restore the volume.

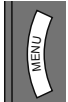

Used to access the TV's onscreen menus. See page 24.



Used to navigate through the TV's onscreen menus.



Go back to a previous onscreen menu or to correct a mistake.

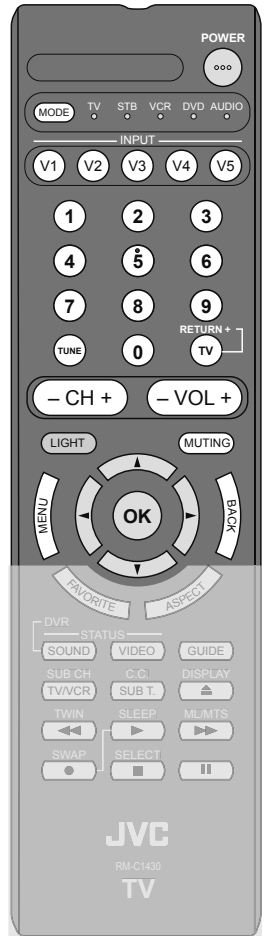

# Remote Control



Save your favorite channels. See page 20.



Change the aspect ratio of the image on your TV screen. See page 20.



Change the sound mode of the MaxxAudio function. See page 21.



Choose different display settings according to personal preferences. See page 21.



Programming information. (**Digital channels only**). See page 21.



Used to select sub channels. (**Digital channels only**). See page 21.



Use the C.C. (Closed Caption) button to select the mode of closed caption. See page 22.



View current channel information.



Activate the split screen option.



Choose how long the TV will stay on before turning off. See page 23.



Listen to a program in stereo, mono or another language (SAP). (Depending on availability in the program). See page 23.



Exchange the channel (or input) displayed in the split screen window for the main screen image.



Select the picture (channel) while viewing split screen.



\* See page 56 for buttons that control your external devices.

# TV Basic Controls

Before you connect your television to another device, please refer to the proper diagrams for your specific TV and remote. These will help assist you in understanding how to connect your television to another device, as well as use the remote to set up your television. Some of the connection terminals are color coded for easy connection with the proper cables.

## Front Panel

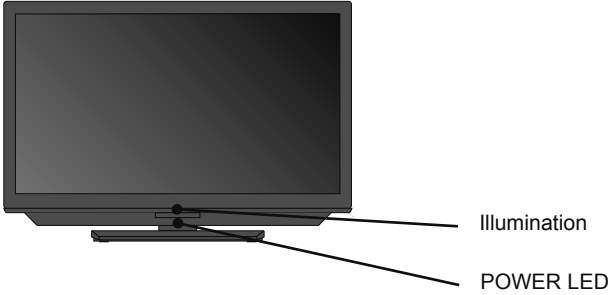

## Side Panel

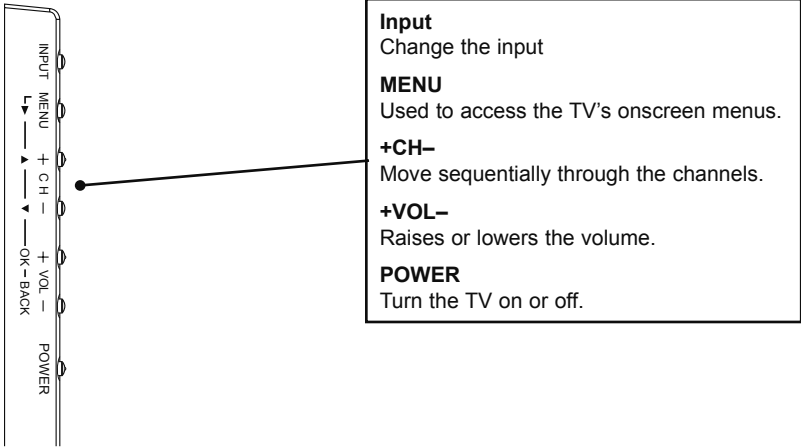

## Rear Panel

- For governing the use of the IR IN terminal, consult your dealer.







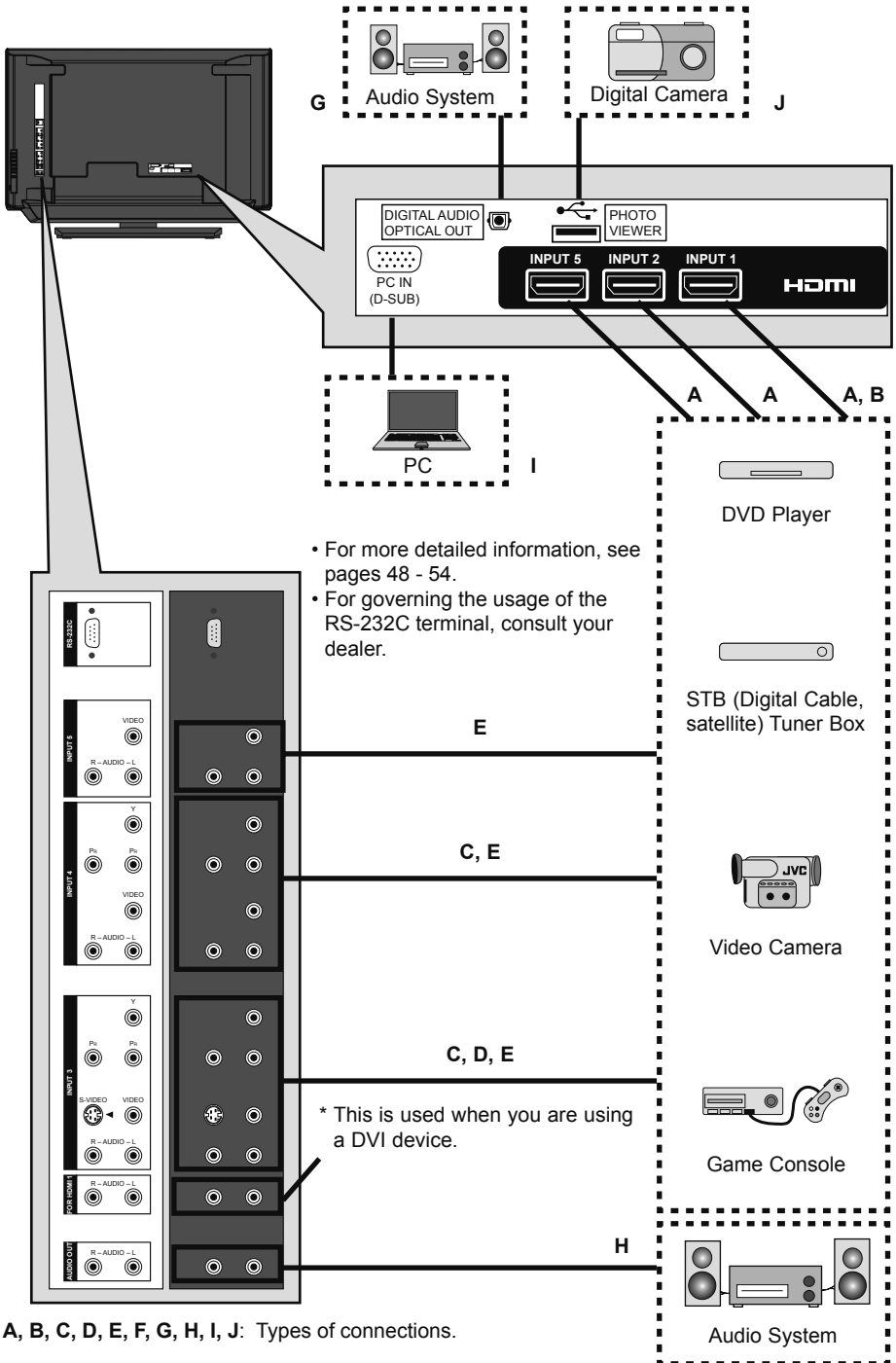





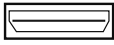

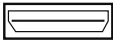
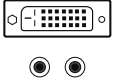
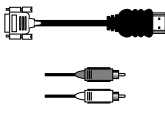
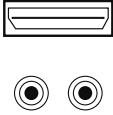
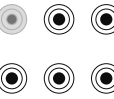
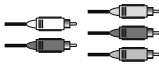
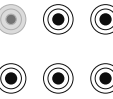

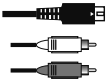



F  
Antenna / Cable

# TV Basic Controls



A, B, C, D, E, F, G, H, I, J: Types of connections.

# TV Basic Controls



		Device Side	With Cables	TV Side
VIDEO and AUDIO ↑ Best ↓ Good	A	 HDMI	 HDMI Cable	 INPUT 1, 2 or 5
	B	 DVI + Audio	 DVI – HDMI Cable, Audio Cable	 INPUT 1 + HDMI ANALOG AUDIO
	C	 Component Video + Audio	 Component Video + Audio	 INPUT 3 or 4
	D	 S-Video + Audio	 S-Video Cable, Audio Cable	 INPUT 3 + AUDIO Input
	E	 Composite Video + Audio	 Composite Video + Audio	 INPUT 3, 4 or 5
	F	 Antenna / Cable (VHF / UHF)	 RF Cable	 75Ω (VHF / UHF)
AUDIO ↑ Best ↓ Good	G	 OPTICAL INPUT	 OPTICAL AUDIO Cable	 DIGITAL AUDIO OPTICAL OUT
	H	 AUDIO INPUT (L / R)	 Audio Cable	 AUDIO OUT (L / R)

# TV Basic Controls

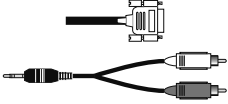

Compatible Signal	Notes
Input <ul style="list-style-type: none"><li>• HDMI (Digital) SD: 480i, 480p HD: 1080/60p / 1080/30p / 1080/24p / 1080i / 720p Audio L/R (Digital)</li></ul>	See page 52.
Input <ul style="list-style-type: none"><li>• DVI (Digital) SD: 480i, 480p HD: 1080/60p / 1080i / 720p</li><li>• Audio L/R (Analog)</li></ul>	See page 51.
Input <ul style="list-style-type: none"><li>• Component (Analog) SD: 480i, 480p HD: 1080i, 720p</li><li>• Audio L/R (Analog)</li></ul>	See page 49.
Input <ul style="list-style-type: none"><li>• S-Video (Analog)</li><li>• Audio L/R (Analog)</li></ul>	
Input <ul style="list-style-type: none"><li>• Composite (Analog)</li><li>• Audio L/R (Analog)</li></ul>	See page 49.
ATSC (Digital) NTSC (Analog) Clear QAM (Digital)	See page 48.
Output <ul style="list-style-type: none"><li>• Audio L/R (Digital) (PCM or Dolby Digital)</li></ul>	See page 50.
Output <ul style="list-style-type: none"><li>• Audio L/R (Analog) (Fixed)</li></ul>	See page 50.

# TV Basic Controls

## PC

	Device Side	With Cables	TV Side
I	 <p>D-SUB + Audio (3.5 mm stereo mini jack)</p>	 <p>D-sub (15 pin) Cable + Audio Cable</p>	 <p>PC IN (D-SUB) + INPUT 5 AUDIO Input</p>

## USB

	Device Side	With Cables	TV Side
J	 <p>USB</p>	 <p>USB Cable</p>	 <p>PHOTO VIEWER</p>



# Key Features

Your JVC TV is equipped with many features. Here are some key features highlighted in detail.

- 1 Stunning picture quality via 1920x1080 Full HD panel. Dynamic Gamma and Color Management give further fine tuned picture reproduction. Smart Picture adjusts the best possible picture quality automatically scene by scene based on the incoming signal from any source!



- 2 "120Hz Clear Motion Drive III technology displays 120 frames per second (120Hz) in the same time a conventional LCD TV displays 60 frames (60Hz). You will be able to reduce blurring or image trails when there is rapid or complex movement across the screen.



On

Off

**i-clear Motion NR** – Provides 3D noise reduction for moving images by applying the high-precision motion prediction techniques.

**Real 12bit Driver** – JVC's new bit extension technology takes 8-bit images and turns them into images with 12-bit precision. It produces smooth, natural signal gradations without sacrificing the original HD signal.

- 3 JVC exclusive twin oblique cone speakers provide excellent TV sound quality. MaxxAudio sound provides you with 4 different settings based on the program you are watching. The equalizer will fine tune your listening preferences.
- 4 Full connectivity with 3 HDMI, 2 Component, 1 S-video and others. The variety of connections are explained on pages 47 to 51.

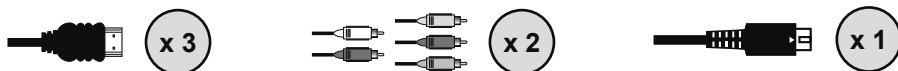

HDMI CEC (see page 42)

- 5 Aspect mode will show every pixel you are getting in High Definition. The Native mode will show 100% of 1080p. Full – with slight overscan. Panorama and Cinema will fill the screen with various aspect settings. See page 40.
- 6 Photo Viewer allows you to enjoy your digital pictures stored on your USB Mass Storage Class devices. See page 45.

# Setup

## Interactive Plug-In Menu

When you turn on your TV for the first time, the Interactive Plug-In Menu appears automatically. These menus will help you setup your TV with basic information for **Language**, **Time** and **Tuner Setup**.



### 1) Turn on the TV



### 2) Set the language

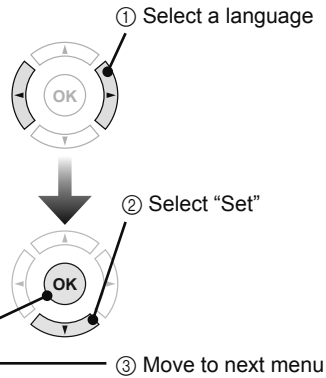

### 3) Set time attribute

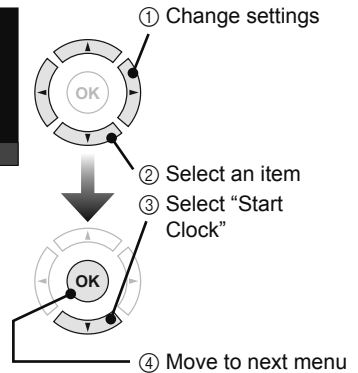

Mode	Auto (Analog), Auto (Digital), Manual
Channel	Only can select when <b>Mode</b> is in <b>Auto (Digital)</b>
Time	Only can select when <b>Mode</b> is in <b>Manual</b>
Time Zone	Choose the time zone you live in.
D.S.T.	Changes the clock automatically for daylight saving time. <b>On / Off</b>

## Interactive Plug-In Menu (Continued)



### 4) Set TV attribute

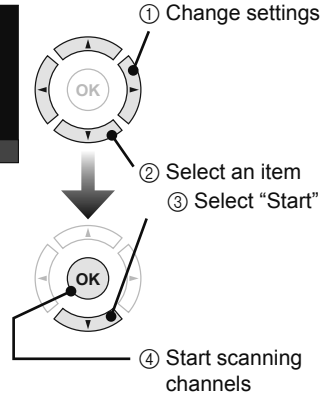

Tuner Mode	Choose Air (antenna), Cable or Skip
Scan Mode	Auto, STD, HRC, IRC

\* If you use a set top box (satellite or cable box), press "Exit" to skip this step.

**Cable Users:** After your auto tuner setup is complete, you may, (depending on the type of hookup), have only 1 channel, usually 2, 3 or 4 in the auto tuner memory. This is normal.

**"Thank you! Setup is now complete"**

# Remote Control Functions



## RETURN+ TV

---

Has three functions.

**Return** – Returns to the channel viewed just before the channel currently onscreen.

**Return+** – Lets you program a specific channel to return to while scanning through the channels using the **– CH +** button as you memorize the channel.

**TV** – Returns to the TV mode as you are watching a video, DVD, etc.

**Note:**

- Press the **RETURN+ TV** and hold for three seconds. This will memorize the current channel to return to while you scan through the other channels. To cancel, press and hold the **RETURN+ TV** button for three seconds.



## FAVORITE

---

Allows you to save channels you like so you can view them easily. First you must register the channels you like.

**Notes:**

- Go to the channel you want to register and press the **FAVORITE** button for three seconds.
- To view your favorite channels, press **FAVORITE**. Move **▲ ▼** to select your channel and press **OK**.
- To erase your favorite channels, press **FAVORITE**. Move **▲ ▼** to select your channel and press **▶**.
- Both analog and digital channels can be registered.
- The newest channel you registered will appear at the top of the list.



## ASPECT

---

Allows you to adjust the way the image appears on your TV based on the format that is being received.

**Panorama / Cinema / Full / Panorama Zoom / Cinema Zoom / Full Native / Regular / Slim**

See page 40.

**Note:**

- You can select the aspect mode by pressing the **ASPECT** button.

# Remote Control Functions



## SOUND

---

Change the sound mode of the MaxxAudio function. **High / Mid / Low / Off**

### Notes:

- You can choose the different sound modes by pressing the **SOUND** button.



## VIDEO

---

Allows you to choose different picture settings according to personal preferences. You can access this feature for each input (TV, V1, V2, V3, V4, V5).

**Standard / Dynamic / Theater / Game / Memory-1 / Memory-2**

### Note:

- You can select **Video Status** by pressing the **VIDEO** button. See page 34.



## GUIDE

---

You can view program information for Digital Channels.

### Note:

- When the program information is not being broadcast, the correct information will not be displayed.
- The GUIDE will not show the correct time and date depending on the Time Zone and D.S.T. settings. See page 43.



## SUB CH

---

Digital broadcast sometimes offers sub channels. By using the **SUB CH** button, you can select a sub channel easily.

For example, to move to sub channel 123-45:

- 1) Press **1**, **2** and **3** in order
- 2) Press the **SUB CH** button
- 3) Press **4** and **5** in order
- 4) Press the **TUNE** button

# Remote Control Functions



## C.C. (Closed Caption)

Use the C.C. (Closed Caption) button to select the mode of closed caption. At first, select TV, STB or VCR mode to use the closed caption function.

### Notes:

- You can change the mode by pressing the ▲▼ buttons and press **OK**.
- Smart Caption will appear when you press the **MUTING** button only on channels where the broadcast contains closed captioning.
- When you select **On**, it will be the mode selected in the Closed Caption Menu.
- See page 32 when you set the caption/text mode.
- If you are in PC mode or use HDMI, C.C. cannot be used.



## TWIN

Activate the split-screen option by pressing **TWIN** on the remote control. The channel (or input) you were watching before pressing **TWIN** will appear on the left, the new channel will appear on the right. To turn split-screen off and return to normal television viewing, press **TWIN** again or press the **BACK** button. At first, select TV mode to use the TWIN function.

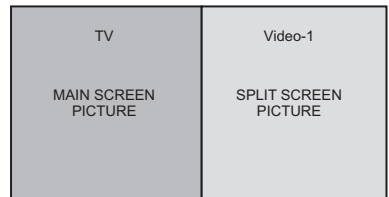

### Notes:

- You can enter the TWIN mode when you are in a single screen.
- Split screen functions will not work when you are receiving a 1080/30p and 1080/24p signal.
- Split screen functions will not work with locked channels or channels blocked by V-Chip ratings limits. A black screen will display instead.
- The aspect of Main Screen Picture becomes 16:9 when you input the picture of 480p, 720p, 1080i and 1080p from the component terminal, HDMI terminal and digital channels.
- When you are in TWIN mode, you cannot change the aspect ratio.
- When you press the **MENU** button in TWIN mode, the menu screen will not appear.
- When you are in PC mode, TWIN, SWAP and SELECT cannot be used.

# Remote Control Functions



## SLEEP

---

Allows you to choose how long the TV will stay on before turning off.

### Notes:

- You can change the interval by pressing the ▲▼ buttons and press **OK**.
- You can set the interval at 0, 15, 30, 45, 60, 90, 120 and 180 minutes.
- 60 seconds before the TV turns off, a message will appear and it will count the remaining time. If you want to extend the time, press the **SLEEP** button and you can change the interval. If you don't press the **SLEEP** button, within 60 seconds the TV will turn off.



## ML/MTS

---

Allows you to listen to a program in stereo, mono sound or another language (SAP) if available. First you must set the **MODE** to **TV** on your remote.

### Notes:

- When you are receiving a digital broadcast, if there are other languages, you can change the language by pressing the **ML/MTS** button.
- Keep the TV in stereo mode to get the best sound quality. The sound will work in stereo mode even if a certain broadcast is in mono sound only.
- Choose the mono setting to reduce excessive noise on a certain channel or broadcast.
- MTS is unavailable if your television's Input source is (**V1, V2, V3, V4, V5**).
- ML/MTS will not work when you are using HDMI or an external input.



## SWAP

---

You can exchange the channel (or input) displayed in the split screen window for the main screen image by pressing the SWAP button. At first, select TV mode to use the SWAP function.

### Notes:

- It will only work in TWIN mode.



## SELECT

---

With **SELECT**, you can select the picture (channel) while viewing split screen. When you press **SELECT** button, the channel banner on the top will be highlighted. Each press of **SELECT** will shift the channel. The sound outputs from the screen you have selected.

# Customizing your TV



## 1) Display the menu bar



## 2) Display the desired menu

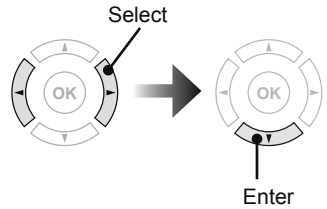
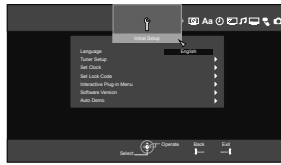

## 3) Change or adjust the setting

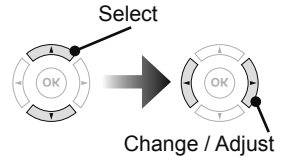

### ■ Change or adjust the setting using the pop-up menu.

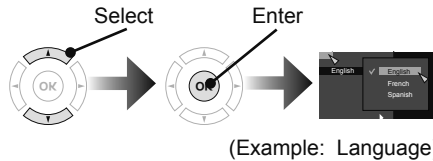

### ■ To enter an item's sub menu

### ■ To the previous screen

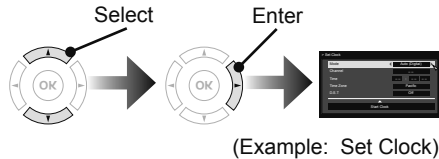

## 4) Close the menu



### Note:

- Depending on the situation (analog channels, digital channels, video signal format, external inputs, etc.), some items will be displayed in gray and can not be selected.



# Customizing your TV

## Initial setup

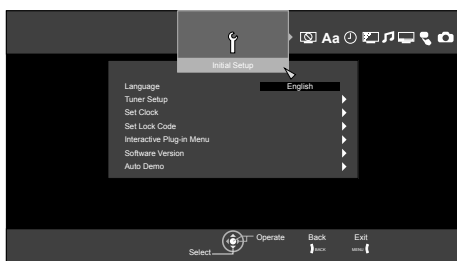

## Language

Allows you to change the TV's onscreen menu languages to English, French or Spanish.

## Tuner Setup

### Auto Tuner Setup

If you skipped this step in the initial setup or your setup has changed, you can redo your setup in this menu. **Air / Cable**

## Channel Summary

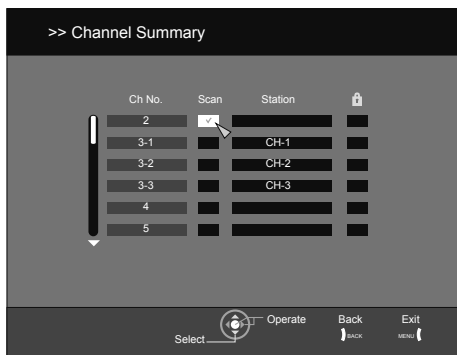

Channel summary allows you to customize the line-up of channels received by your TV. Regarding analog channels, you can add or delete channels from the line-up or prevent any unauthorized viewers from watching any or all 181 channels. Regarding digital channels, the only channels that will appear are the ones that are broadcasting.

The Channel summary screen will now be displayed with the channels set to scan marked with an "✓". Regarding analog channels, you can delete channels from the scan by removing the "✓". If any channels were missed during auto tuner setup and you wish to add them, you may be placing an "✓" next to the channel number.

### Note:

- The number of a digital channel may change, depending on the time of some broadcastings. If this channel existed and now has disappeared, the lock channel or scanned channel mark by the channel summary for that channel will be cancelled.

# Customizing your TV

## Initial setup (Continued)

### Channel Summary (Continued)

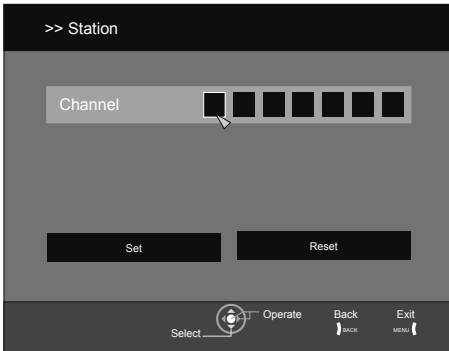

You can set the channel label by selecting the **Station** column.

#### Notes:

- You can use characters for: Alphabet, numbers, marks and spaces.



You can block access to a channel by activating the channel lock. Select the  column.

### Find Channel

Allows you to add channels by pressing the 10 key pad.

### Digital Antenna Level

This is a bar graph displaying the state of the Digital Antenna Level.

### Tuner Diagnostic

(Service Use Only)

## Set Clock

The set clock function is described on page 18 as the Interactive Plug In Menu. You can choose to set the clock automatically or manually.

# Customizing your TV

## Initial setup (Continued)

### Set Lock Code

Channel guard and V-Chip settings are protected by a four-digit lock code. Your TV comes preset with a lock code of "0000". You may change the code to any four-digit number you wish.

**Notes:**

- After a power interruption you must reset the lock code.
- Write your lock code number down and keep it hidden from potential viewers.
- If you forget the lock code, a new code may be set using the steps listed above.

### Interactive Plug-In Menu

If you skipped this step in the initial setup or your setup has changed, you can redo your setup in this menu. The Interactive Plug-in Menu is described on page 18.

### Software Version

You can confirm the TV's software version.

### Auto Demo

Auto Demo explains this TV's features to you.

**Notes:**

- Please complete the Initial Setup menu first. The Auto Demo mode will start automatically when the Interactive Plug-In Menu is completed.
- If you press any button on the television or remote, with the exception of **POWER** or **MENU**, the Auto Demo mode will stop for 30 seconds. After 30 seconds have passed with no operation, the Auto Demo mode will start again.
- If you want to turn off the Auto Demo, press the **MENU** button.

# Customizing your TV

## V-Chip

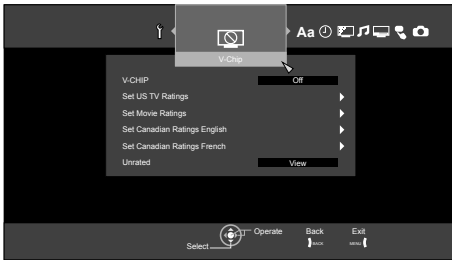

### Notes:

- V-CHIP will not work with video signals from VCRs, DVD players, Blu-ray or camcorders connected to the TV.
- **(For Canadian viewers only):** V-CHIP is designed specifically for the US and may not work properly in Canada.
- “Advanced V-Chip Rating” and “Advanced Canadian Rating” menus may be displayed sometimes. This depends on the broadcast you are receiving.

### – When entering the password –

When you try and access the V-Chip menu, “Please input password” will appear. Press the “0” button four times on your remote to access the V-Chip menu for the first time.

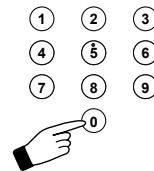
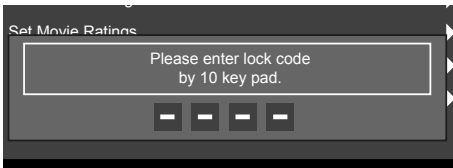

### – When you lock or unlock channels –

You can lock or unlock ratings as shown below.

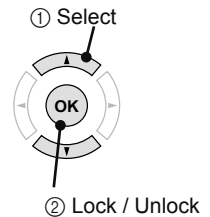
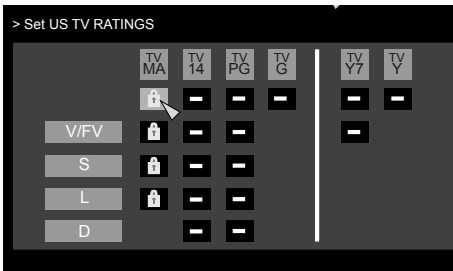

### Note:

- Once a channel has been unlocked, it will remain unlocked until the television is turned off.

# Customizing your TV

## V-Chip (continued)

### V-Chip

Allows you to block channels or content that you deem inappropriate for children. **On / Off**

### Set US TV Ratings

This setting is based on the US ratings system.

**TV Y – Appropriate for all children.**

Intended for all children 2 - 6 years old.

**TV Y7 – Appropriate for older children.**

Intended for children 7 years or older.

**TV G – General Audience.**

Suitable for all ages.

**TV PG – Parental Guidance Suggested.**

Suitable for all ages with parental guidance.

**TV 14 – Parents Strongly Cautioned.**

Intended for viewers 14 years or older.

**TV MA – Mature Audiences Only.**

Intended for viewers 18 years or older.

**Viewing Guidelines:**

In addition to the above ratings, you can also block or allow more specific content. **(Except for unrated programming).**

A program can contain any or all of the following:

**V/FV – VIOLENCE/FANTASY VIOLENCE**

**S – SEXUAL CONTENT**

**L – Strong LANGUAGE**

**D – Suggestive DIALOG**

# Customizing your TV

## V-Chip (continued)

### Set Movie Ratings

This setting is based on the US Motion Picture Association of America (MPAA) ratings system.

**NR – Not Rated.**

Any type of programming that does not contain a rating.

**G – General Audience.**

Suitable for all ages.

**PG – Parental Guidance Suggested.**

Suitable for all ages with parental guidance.

**PG 13 – Parents Strongly Cautioned.**

Intended for viewers 13 years or older.

**R – Restricted.**

Not recommended for viewers 17 years without parental guidance.

**NC-17 – No One Under 17.**

Not intended for viewers 17 years or younger.

**X – No One Under 18.**

Not intended for viewers 18 years or younger.

## V-Chip (continued)

### Set Canadian Ratings English

This setting is based on the Canada rating system.

**E – Exempt.**

Any type of programming that does not contain a rating.

**C – Intended for children.**

Suitable for all ages.

**C8+ – Intended for children over 8 years old.**

Suitable for all ages over 8 years.

**G – General Audience.**

May contain material not suited for younger viewers.

**PG – Parental Guidance.**

May contain material not suited for younger viewers. Parents may consider some content not appropriate for children 8 - 13 years old.

**14+ – 14 Years or Older.**

Parents strongly urged to use their discretion in allowing viewing by persons under 14.

**18+ – Adult.**

Intended for viewers 18 years or older.

### Set Canadian Ratings French

For instructions on “Set Canadian Ratings French”, please see page 31 in the French user’s guide.

### Unrated

You can block programs that are not rated.

Unrated programming refers to any programming which does not contain a rating signal.

Programming on television stations which do not broadcast rating signals will be placed in the “Unrated Programming” category.

Examples of Unrated programs:

- Emergency Bulletins
- News
- Public Service Announcements
- Sports
- Some Commercials
- Locally Originated Programming
- Political Programs
- Religious Programs
- Weather

**Note:**

- TV programs or movies that do not have rating signals will be blocked if the unrated category is set to **Block**.

# Customizing your TV

## Closed Caption



## Closed Caption

Allows you to select the mode of the closed caption. First you must set the **MODE** to either **TV**, **STB** or **VCR** on your remote. **On / Smart Caption / Off**

### – Smart Caption –

Will display closed captioning when you press the **MUTING** button only on channels where the broadcast contains closed captioning.

### Type

**Auto:** Shows closed caption a priority for digital channels over analog channels. It is set automatically.

**Advanced:** Shows only the digital closed caption.

**Basic:** Shows only the analog closed caption.

### Analog Service

Choose the feature that you like for analog Closed Captioning.

### Digital Service

Choose the feature that you like for digital Closed Captioning.

### Appearance Mode

**Auto / Manual**

### Font Size

Choose how big the text appears in Closed Captioning.

### Font Style

Choose the style of the font in Closed Captioning.

### Text / Edge Opacity

Choose how translucent the text appears in Closed Captioning.

### Background Opacity

Choose how translucent the background box color for the Closed Captioning text.

### Text Color

Choose the color of the text in Closed Captioning.

### Edge Color

Choose the color of the border of the background box color for the Closed Captioning text.

### Background Color

Choose the background box color for the Closed Captioning text.

## Reset

Resets all adjustments except for **Closed Caption** at once to the default settings.



## On/Off Timer



### Notes:

- In order for the **On/Off Timer** to work, the clock must be set.
- After a power interruption, the timer settings must be reset.
- If your clock is not set, "PLEASE SET CLOCK FIRST !" will appear on the screen.

## Mode

You can select timer frequency. **No / Once / Everyday**

## On Time

You can set the time you want the television to turn itself on.

## Off Time

You can set the time you want the television to turn itself off.

## Channel

You can set the channel of when **On Timer** is on.

### Note:

The **On/Off Timer** cannot be set to locked or guarded channels.

## On Volume

You can set the volume level when **On Timer** is on.

**0 - 50:** Volume level

**Current:** Start with current volume level.

## Set

Set all settings of **On/Off Timer** menu.

### Note:

- If you are out from **On/Off Timer** menu without pressing **Set**, all settings go back to previous setting.

# Customizing your TV

## Picture Adjust



## Video Status

Choose different display settings according to personal preferences. You can use this feature with TV, V1, V2, V3, V4 and V5.

**Standard** – Resets the picture display to the factory settings.

**Dynamic** – Gives a vivid picture with better contrast when viewing in a brightly lit room.

**Theater** – Gives a rich, film-like look to video when viewing in a dimly lit room.

**Game** – Used for when you are playing video games connected to your TV.

**Memory-1 / Memory 2** – You can memorize your favorite picture settings (Tint, Color, Picture, Bright, Detail, Energy Saver Mode)

### Notes:

- Each mode is memorized for each input (TV, V1, V2, V3, V4, V5) connected to the TV.
- Each video status setting has a separate memory for HD (1080i/1080p/720p) and SD (480p/480i) video signal. Each video status can be chosen along with your favorite picture settings (Tint, Color, Picture, Bright, Detail and Energy Saver Mode).
  - When an HD or SD signal is displayed, your HD or SD settings are recalled for the video status you are using.

■ Allows you to change and adjust the way the picture appears on your television.

### Tint

Allows you to adjust the levels of red and green on your TV.

### Color

Allows you to make all the colors on your TV appear more vivid or subtle.

### Picture

Allows you to adjust the level of black and white on your TV giving you a darker or brighter picture overall.

### Bright

Allows you to adjust the overall brightness of the TV.

### Detail

Allows you to adjust the level of fine detail on your TV.

### Energy Saver Mode

Allows you to adjust the brightness of the internal lamp which effects the overall brightness of the TV.

# Customizing your TV

## Picture Adjust

### Natural Cinema

Allows you to compensate for image blurring when the original video you are watching was shot at 24 frames/sec, and is broadcast at 30 frames/sec. This conversion error is known as "TELECINE". **Auto / On / Off**

#### Notes:

- When you are receiving a 480p, 720p, 1080p signal, or in PC mode, Natural Cinema cannot be selected.
- Natural Cinema is only applied for SD 480i and HD 1080i signals.

### Theater Pro II

It is possible to use Theater Pro II menu only when the Video Status mode is set to Theater, Memory-1 or Memory 2. It adjusts the detailed picture settings.

Theater Pro II Menu	Settings
DSD Detail	Shows the edge of the picture clearly
H.Sharp	Emphasizes the edge of the picture horizontally
V.Sharp	Emphasizes the edge of the picture vertically
DSD Noise Control	Reduces picture noise
Color Temp. (High, Low)	Adjusts the screen (red, blue or green) color
Color Balance	Adjust the blue color naturally
*Color Mngmt. (Red, Yellow, Green, Cyan) Axis	Select a corrected color
*Color Mngmt. (Red, Yellow, Green, Cyan) Tint	Adjusts the tints of (red, yellow, green or cyan)
*Color Mngmt. (Red, Yellow, Green, Cyan) Color	Adjusts the color of (red, yellow, green or cyan)
*Color:Bright Area	Adjusts the picture color of the bright areas
*Color:Dark Area	Adjusts the picture color of the dark areas

\* These Theater Pro II menus cannot be selected when Color Management is OFF. See page 36.

#### – Reset

Resets all **Theater Pro II** menu picture adjustments.

### x.v.Color

This makes full use of the display's capabilities to produce the perception of depth-of-field and texture. **Auto / On / Off**

## x.v.Color

x.v.Color and **x.v.Color** are trademarks.

### Color Temp

Allows you to change how strong or dull the colors appear.

**High** - Bluish picture

**Low** - Reddish picture

# Customizing your TV

## Picture Adjust (continued)

### Color Management

Allows you to compensate for dull colors to ensure dull colors are reproduced with natural hues.  
**On / Off**

### Dynamic Gamma

Allows you see more detail in very dark or bright areas so these areas don't appear "muddied". Normally, this feature should be left **On** for optimum picture quality. **On / Off**

### Smart Picture

Allows you to adjust the brightness level automatically to a level suitable for what you are watching. **On / Off**

### Digital VNR

This function can be selected to change the effect of Digital VNR (Video Noise Reduction).  
**Auto / Max / Min / Off**

### MPEG NR

This function effects the block noise removal and mosquito NR (Noise Reduction) simultaneously. **Max / Min / Off**

#### Note:

- When you are receiving digital channels, block noise removal will have no effect.

### Smart Sensor

This function automatically adjusts the brightness on your TV according to the amount of light in the room. **Display / On / Off**

– Display –

"Leaf" icon will appear on your TV screen when **Smart Sensor** brightness adjustment occurs. The leaf icon will appear a maximum of 6 leaves.

### Reset

Resets all picture adjustments at once to the default settings, except for Video Status and Natural Cinema.

# Customizing your TV

## Sound Adjust



MaxxAudio improves sound performance with four sound features (MaxxBass, MaxxTreble, MaxxStereo and MaxxVolume). **High / Mid / Low / Off**

■ Allows you to change and adjust the four sound features on your television.

**MaxxBass** – Compensates for low frequencies and widens the frequency band.

**MaxxTreble** – Compensates for high frequencies and widens the frequency band.

**MaxxStereo** – Expands the stereo sound naturally.

**MaxxVolume** – Maintains a uniform sound volume even if the sound becomes too loud all of the sudden (during commercial breaks, etc.). **On / Off**

### Note:

- Adjustment made to the four sound features (MaxxBass, MaxxTreble, MaxxStereo and MaxxVolume) will be stored in the selected “MaxxAudio” setting.



MaxxAudio is a registered trademark of Waves Audio Ltd. in the USA, Japan and other countries.

## Balance

Adjust the level of sound between the TV's left and right speakers with the balance setting.

## Turn On Volume

Turn On Volume allows you to set the volume level when you turn the TV on.

## Volume Limit

Volume Limit allows you to set the maximum volume level.

# Customizing your TV

## Sound Adjust (continued)

### Optical Out

You can select the optical digital sound output as PCM or DOLBY DIGITAL when your TV is connected to an amplifier that has a DOLBY DIGITAL decoder. If you select DOLBY DIGITAL, you can enjoy listening to 5.1ch sound when watching digital broadcasts. This only applies to digital channels.

#### Notes:

- Optical Out can be used for both digital and analog channels.
- If your amplifier does not have DOLBY DIGITAL decoder, select PCM. If you don't select PCM, it cannot output the sound from the speakers.
- For connecting an amplifier using the optical output, see page 50.



Manufactured under license from Dolby Laboratories. "Dolby", and the double-D symbol are trademarks of Dolby Laboratories.

### Reset

Resets all sound adjustments at once to the default settings, except for MaxxAudio.

# Customizing your TV

## Features

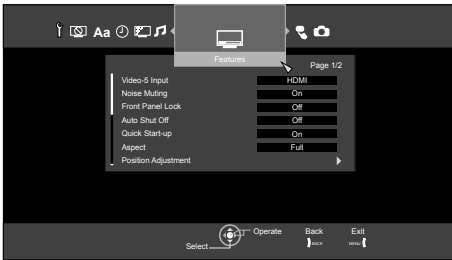

## Video-5 Input

Allows you to choose the signal type you wish to receive that you have connected to Video-5 Input. **HDMI / D-sub / Composite**

## Noise Muting

This feature inserts a blank black screen over channels which are not broadcasting or are too weak to be received clearly. **On / Off**

## Front Panel Lock

This allows you to lock the keys on the side of the TV. **On / Off**

## Auto Shut Off

“Auto Shut Off” will work when there is no signal and there is no TV operation for 10 minutes. “Auto Shut Off” will not work while you are receiving a signal, even though there is no TV operation for 10 minutes. **On / Off**

### Note:

- If the channel that you have on does not receive a signal for more than one minute, the blinking text “No Program or Weak Signal Auto shut off in 9 min.” appears on the screen, and starts the countdown. If no signal is being received within 10 minutes, the TV shuts itself off.

## Quick Start-up

This allows you to quickly start the TV by skipping over the JVC logo on the TV screen when you press the **Power** button. **On / Off**

# Customizing your TV

## Features (continued)

### Aspect

Allows you to adjust the way the image appears on your TV based on the format that is being received.

**Panorama** - When watching a 4:3 aspect picture it is stretched to fit the dimensions of the 16:9 aspect screen.

**Cinema** - This ratio “zooms in” on the center part of a 4:3 aspect picture, blowing it up proportionally to fill the 16:9 screen.

**Full** - When watching a 4:3 aspect picture, it is stretched to fit the dimensions of the TV. When watching a 16:9 aspect picture, it displays 95% of the ratio.

**Panorama Zoom** - When watching a High-Definition 16:9 aspect picture it is stretched to eliminate the black side bars.

**Cinema Zoom** - This ratio “zooms in” on the center part of a High-Definition 16:9 aspect image to eliminate the black surrounding bars.

**Full Native** - This ratio displays 100% of the ratio. Normally, all aspects except for **Full Native** display about 95%.

**Regular** - When watching a 4:3 aspect picture without modifying the original picture to fit the dimensions of your 16:9 screen. Black bars will appear along the picture’s sides. The picture will be centered within the boundaries of the 16:9 screen.

**Slim** - This aspect mode shrinks the screen of a 16:9 broadcast to 4:3. There are some programming that is already stretched by mistake at broadcasting companies, so this mode corrects it. Black side bars will appear.

#### Notes:

- Depending on the signal format, some aspect modes are unavailable.
- Slim can only be displayed when the signal is ATSC (720p, 1080i) or HD (720p, 1080i, 1080p).
- Full Native can only be displayed when the signal is ATSC (1080i) or HD (1080i, 1080p).
- If the television receives a 16:9 signal from your HDMI device, the aspect mode will turn to Full automatically. If the television receives a 4:3 signal from your HDMI device when you are in Full aspect mode, it will return to aspect mode you chose. If you change the aspect mode after the television changed it to Full automatically, the television will change to the aspect mode you choose. It also turns to Full automatically when the TV receives an HD (1080p, 1080i or 720p) signal.
- You can access the aspect modes using the buttons on the side of the TV, by using the **MENU** button, then – **CH +** button.
- You can select **Regular** or **Full** in PC mode.



# Customizing your TV

## Features (continued)

### Position Adjustment

Position adjustment allows you to adjust the position of the picture on the screen vertically when the aspect is set to panorama or cinema.

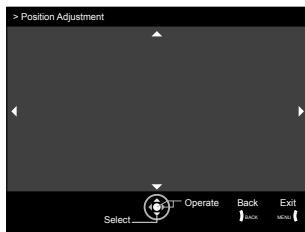

#### Notes:

- To reset the adjustment to the center, press the **OK** button.
- When the arrow disappears, while you are adjusting the position, the position is at its maximum limit.
- If you select **Regular**, **Slim**, **Full** or **Full Native** size with aspect or Multi Screen, position adjustment option is not selected.
- When you change the screen size, perform the position adjustment again.
- Position adjustment allows you to adjust the screen position vertically and horizontally when the aspect is set Panorama Zoom or Cinema Zoom for 1080p, 1080i and 720p signals, or when PC mode is set.
- It is also possible to use Position Adjustment when you are in PC Mode.

### Illumination

Allows you adjust the brightness of the illumination on the front of the TV.

**High / Low / Off**

### Power Indicator

Allows you adjust the brightness of the POWER LED on the front of the TV.

**High / Low / Off**

### HDMI Size

The HDMI Size menu can only be selected when an HDMI 480p picture signal is being input to the HDMI terminal. This option adjusts the position when an HDMI or DVI 480p picture signal is being displayed on the screen. There are two types of HDMI 480p picture signals: 640x480 and 720x480. If the displayed picture is slightly shifted, the position can be adjusted by selecting **Auto**, **Size1** or **Size2**.

#### Note:

- You can select **Auto** only when the signal is 480p for HDMI. When you select **Auto**, the television will select "**Size1**" or "**Size2**" automatically.

# Customizing your TV

## Features (continued)

### Control with HDMI

If you use a HDMI CEC compatible device, set this setting to “**On**”.

HDMI CEC (Consumer Electronics Control) allows the TV to connect and control multiple HDMI CEC enabled devices with a single remote. CEC (Consumer Electronics Control) is an optional protocol used in HDMI.

- HDMI CEC on this TV is compliant with “High-Definition Multimedia Interface Specification”.
- The TV does not support HDMI CEC functions that are not listed below.
- The TV does not guarantee to support use of all HDMI CEC enabled devices.
- Devices that are not enabled to HDMI CEC cannot be controlled with this TV.

#### – Control the TV using the HDMI CEC enabled device –

- Turn the TV on and switch to the video source of the operating device.
- Switch to the video source of the operating device.
- Turn the TV off with the HDMI CEC enabled device you are viewing.
- For operating instructions of the device, refer to the device’s manual.

#### – Control the HDMI CEC enabled device using the TV –

- Turn off the operating device by turning off the TV.
- Some device may not support this function. For more details refer to the device’s manual.

#### – Send status of the TV to the HDMI CEC enabled device –

- When switching the TV’s external input or channel.
- When switching the TV’s menu language.
- Information regarding behavior of the device when status is received, refer to the external device’s manual.

#### If “HDMI CEC” does not work correctly:

- When HDMI CEC enabled device is connected to INPUT1, INPUT2 or INPUT5 with an HDMI cable, you may not be able to control TV’s external input. To solve the problem set “**HDMI CEC**” to “**Off**”.

### Video-1 Audio

Set to “**Digital**” or “**Auto**” for HDMI devices, or “**Analog**” or “**Auto**” for DVI devices for INPUT1. (Not available for INPUT2 and INPUT5)

### Video Input Label

Allows you to label all the devices you have connected to the TV that use the VIDEO-1, 2, 3, 4 and 5 inputs.

**VCR / DVD / Blu-ray Disc / PVR / D-VHS / STB / SAT / AMP / GAME / CAM / DISC**

#### – Reset

Resets all Video Input Label settings.

# Customizing your TV

## Key Items

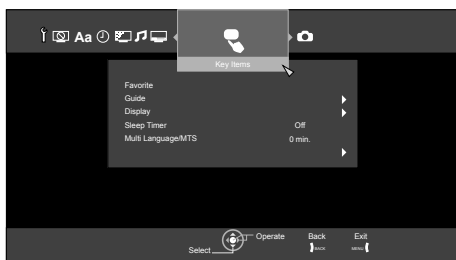

## Favorite

The Favorite button allows you to select your favorite channels easily. First, you must register the channels that you like. See page 20.

## Guide

You can view program information.

### Notes:

- The GUIDE function will work when you are receiving digital program only.
- The GUIDE will not show the correct time and date if you have not performed the set clock function on your television.
- When the program information is not being broadcasted, it will not show the correct information.

## Display

Change display of channel banner, clock etc..

**Banner/Clock / Clock / Short Banner / Off**

## Sleep Timer

Allows you to choose how long the TV will stay on before turning off. First set the **MODE** to **TV**.

**0 min. / 15 min. / 30 min. / 45 min. / 60 min. / 90 min. / 120 min. / 180 min.**

### Note:

- 60 seconds before the TV turns off, a message will appear and it will count the remaining time. If you want to extend the time, press the **SLEEP** button and you can change the interval. If you don't press the **SLEEP** button, within 60 seconds the TV will turn off.

# Customizing your TV

## Key Items (continued)

### Multi Language/MTS

Allows you to listen to a program in stereo, mono sound or another language (SAP).  
*(Depending if available in the program).* First you must set the **MODE** to **TV** on your remote.

#### Notes:

- When you are receiving a digital broadcast, if there are other languages, you can change the language by pressing the **ML/MTS** button.
- Keep the TV in stereo mode to get the best sound quality. The sound will work in stereo mode even if a certain broadcast is in mono sound only.
- Choose the mono setting to reduce excessive noise on a certain channel or broadcast.
- MTS unavailable if your television's input source is **(V1, V2, V3, V4, V5)**.
- ML/MTS will not work when you are using the HDMI and external input.

# Customizing your TV

## Photo Viewer

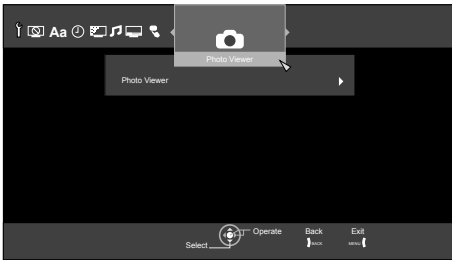

Connect your USB Mass Storage Class device to the Photo Viewer terminal on the TV. Photo Viewer allows you to enjoy your digital pictures stored on your USB Mass Storage Class devices. You can view them on the TV in high quality.

### Notes:

- Gently pull out your USB device from the Photo Viewer terminal after finishing the “Photo Viewer” menu.
- Device can only be selected when you have two or more USB devices connected to the TV.
- Photo Viewer cannot be guaranteed to work with all USB Mass Storage Devices. It may take some time to display or it may not display correctly.
- Please refer to the Customer Support website at [www.jvc.com/support](http://www.jvc.com/support) for information and notes regarding your devices you wish to connect.
- Supported file formats are “.jpg” or “.JPG”.
- All your stored data should be backed up first as a precaution before connecting to the TV.
- Depending on your stored file size, it can take extra time to display “Photo Viewer” page.

## Device

Select your devices such as USB memory or digital camera.

### Note:

- By using the USB hub, you can connect several devices. Choices are different depending on your connected devices.

## Multi Screen

Display digital pictures stored on your USB Mass Storage Class devices in thumbnail view.

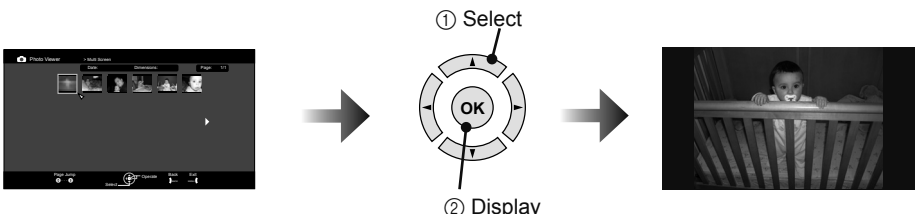

# Customizing your TV

## Photo Viewer (continued)

### Multi Screen (continued)

Choose thumbnail view by pressing ▲▼ or ◀▶ and press the **OK** button. It will now be shown on the screen. To move to the next picture, press the ◀▶ buttons.

- To go to the next page, select the right end image and press the ▶ button. To go back to the previous page, select the left end image and press the ◀ button.
- Press ① - ⑨ buttons to display the page you want in Multi Screen.
- By pressing **DISPLAY** button, you can display control help screen and detailed information of the picture when you are viewing a single image. Change the screen of control help and detailed information by pressing **DISPLAY** button several times.

### Preview Guide

You can display control help screen when you watch the picture. **On / Off**

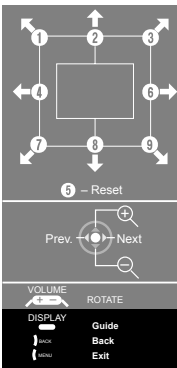

**VOL +**: 90° right-handed rotation

**-VOL** : 90° left-handed rotation

①②③④⑤⑥⑦⑧⑨ : Move to display area in each direction (only when zoomed in)

⑤ : Resets to default condition

▲ : Zoom in

▼ : Zoom back

**BACK**: Back to Multi screen

**MENU**: Back to TV

### Notes:

- Rotation settings are also memorized for Slide Show. But if you disconnected the USB Mass Storage Class device or you turn TV off, rotation settings are reset to default settings.
- Zoom in, Zoom back or position settings are only valid in current display.

## Slide Show

Display your picture image one after another automatically. Display pattern depends on **Slide Show Transition** (Page 47) and interval depends on **Interval Time(sec.)** (Page 47).

# Customizing your TV

## Photo Viewer (continued)

### Slide Show Transition

Allows you to choose display pattern of Slide Show.

**Fade / Slide / Wipe / Zoom / Blind / Shuffle**

#### – Shuffle –

Will display the pictures in 5 patterns randomly of **Fade, Slide, Wipe, Zoom** and **Blind**.

### Interval Time(sec.)

Allows you to change Slide Show interval. **1-10 / 15 / 20 / 30 / 45 / 60 / 90 / 120 / Manual**

#### – Manual –

You can slide the picture by pressing the ◀ ▶ buttons.

#### Note:

- Slide Show may take extra time more than what you set in the Interval Time. This depends on how large the file size is of the picture.

# Connecting Your Devices

## Notes:

- The following connection diagrams are examples on connecting some of the most common devices to your TV. Please refer to your device's instruction manual on other connection methods or for devices not shown here in this instruction book.
- When you are finished connecting your devices, turn on your TV and devices.

## Connect an Antenna or Basic Cable

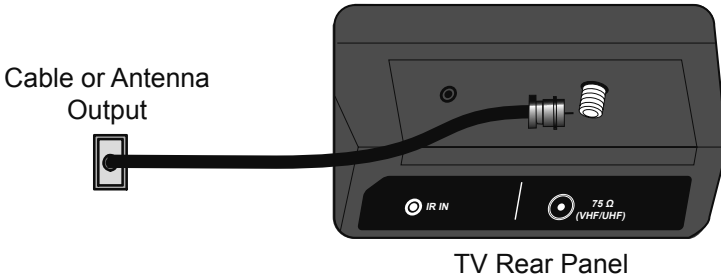

## Notes:

- If you are able to receive ATSC (Digital terrestrial) signal, High Definition (HD) broadcasting can be watched.
- All digital broadcasting is not necessary High Definition. Check by pressing the **DISPLAY** button.
- Digital broadcasting is not available in all areas.

## Connect a Cable Box

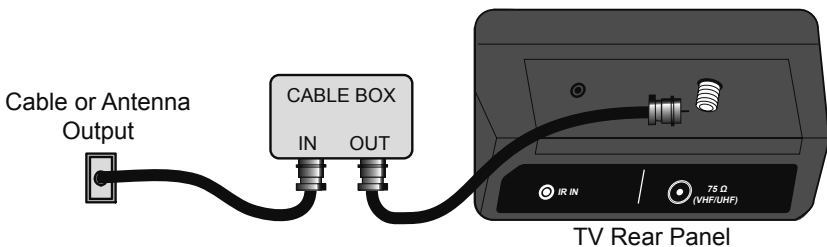

## Note:

- To view channels on your cable box, make sure your TV's channel is set to 2, 3 or 4 (depending on the area you live in).



# Connecting Your Devices

## Connect a DVD Player

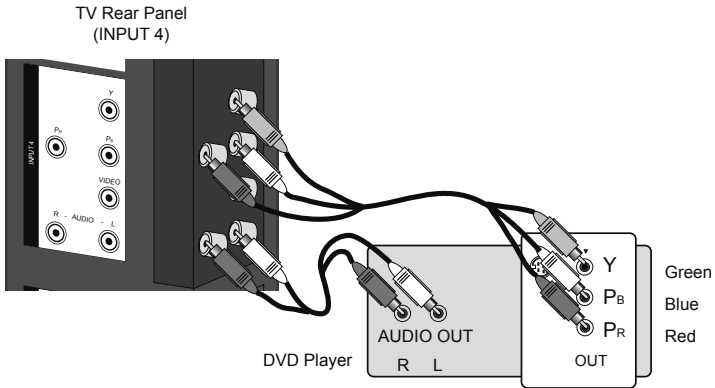

### Notes:

- Green, blue and red are the most common colors for Component Cables. Some models may vary in color.
- To watch your DVD player, make sure your TV is displaying INPUT 3 or INPUT 4 by pressing the **V3** or **V4** button on your remote control.

## Connect a Camcorder

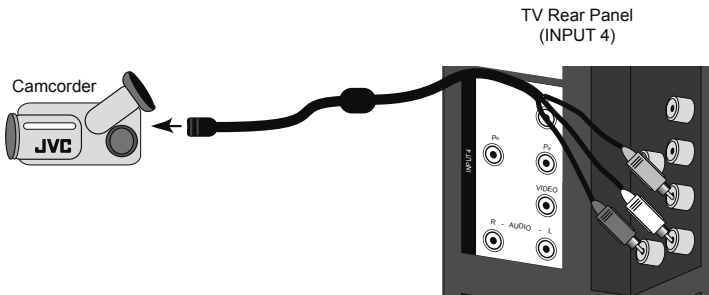

### Note:

- To watch video from your camcorder, make sure your TV is displaying INPUT 3, INPUT 4 or INPUT 5 by pressing the **V3**, **V4** or **V5** button on your remote control.

# Connecting Your Devices

## Connect an Amplifier or Home Theater System

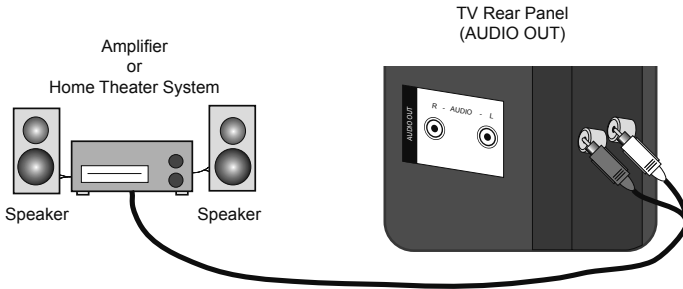

### Note:

- Refer to your amplifier's or Home Theater System's manual for more information.

## Connect an Amplifier using the DIGITAL AUDIO OPTICAL OUT

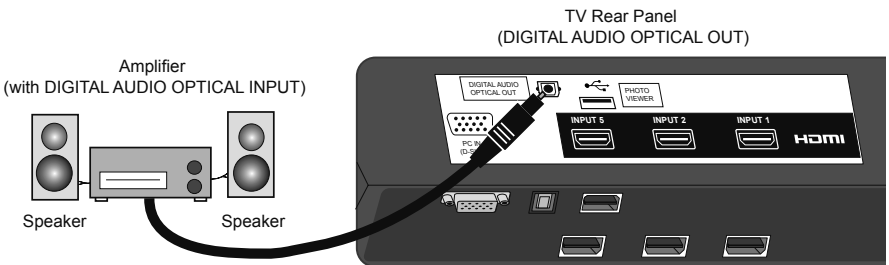

### Notes:

- Refer to your amplifier's manual for more information.
- This terminal can only output digital audio (PCM or DOLBY DIGITAL).
- In order to use the optical output connection, select PCM or DOLBY DIGITAL. See page 38.

# Connecting Your Devices

## Connect a Digital TV Device

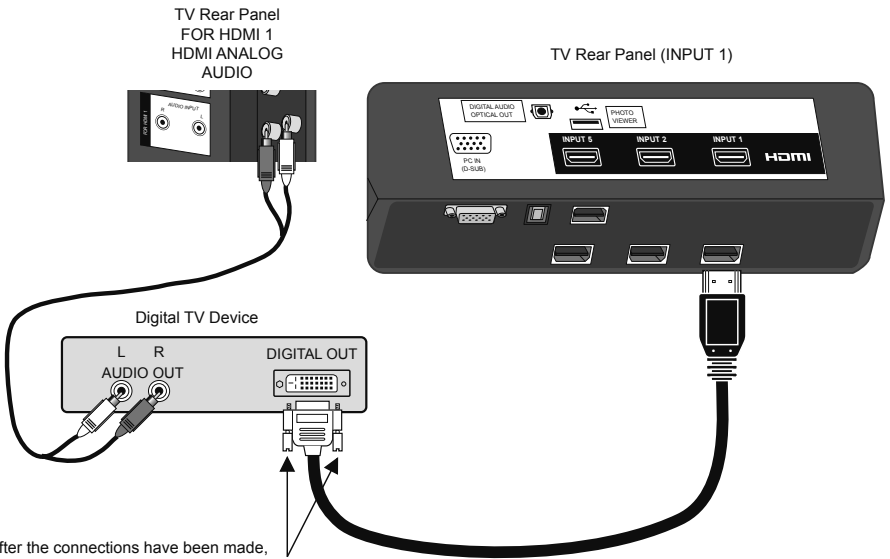

After the connections have been made, tighten the screw to secure the cables.

### Notes:

- To watch your Digital TV device, make sure your TV is displaying INPUT 1 by pressing the **V1** button on your remote control.
- This TV can accept 480i, 480p, 720p, 1080i and 1080p signals via HDMI.

## Connect a IR IN Device

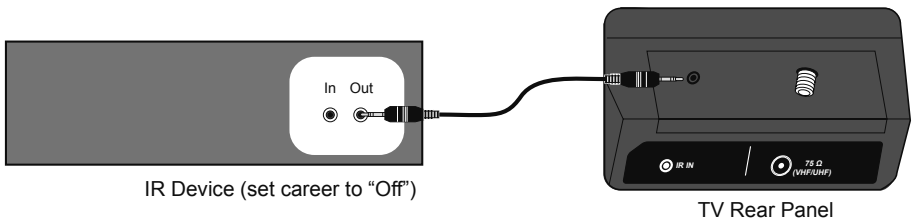

### Note:

- Refer to your IR Device's manual for more information.

# Connecting Your Devices

## Connect a Blu-ray or HDMI Device

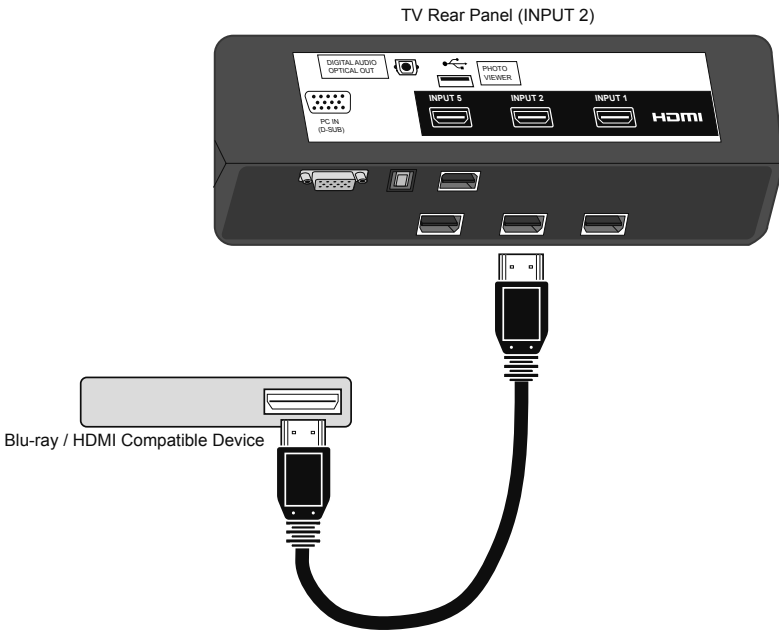

### Notes:

- To watch your Blu-ray or HDMI device, make sure your TV is displaying INPUT 1, INPUT 2 or INPUT 5 by pressing the **V1**, **V2** or **V5** button on your remote control.
- Some decoders may not respond depending on the equipment that is connected to the HDMI.
- This TV can accept 480i, 480p, 720p, 1080i and 1080p signals via HDMI.
- This JVC television can accept a variety of HD signals, including 1080/60p, 1080/60i, 1080/30p, 1080/24p and 720/60p.
- Please use a High Speed HDMI™ Cable. High Speed HDMI™ Cables are tested to carry an HD signal up to 1080p and higher.
- Some HDMI Output Devices may fail to detect this TV as a 1080p device. If this occurs, manually select 1080p on the HDMI Output Device.

HDMI™ (V.1.3, with Deep Color, with x.v.Color™)

**HDMI**™  
HIGH-DEFINITION MULTIMEDIA INTERFACE

HDMI, the HDMI Logo and High-Definition Multimedia Interface are trademarks or registered trademarks of HDMI Licensing LLC.

# Connecting Your Devices

## Connect an AV Receiver using SMART INPUT (INPUT 3)

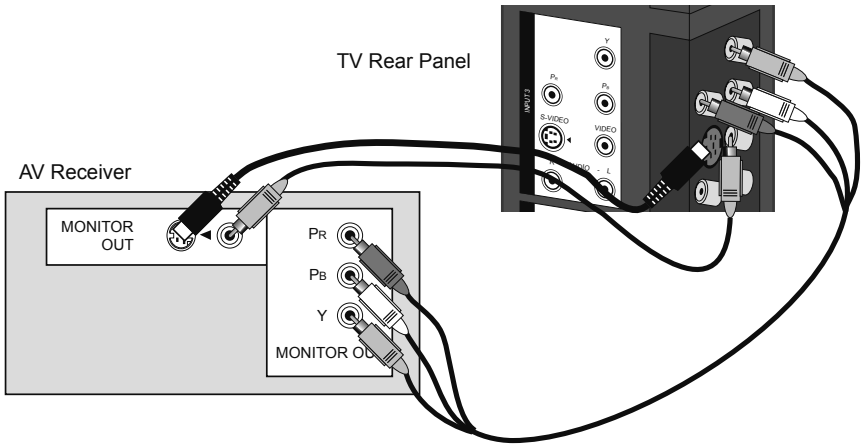

Your TV is equipped with a SMART INPUT (INPUT 3). This allows you to watch many different devices connected to your AV Receiver without having to change or use other input connections on your TV. This allows you to free up the other input connections so you can connect more devices to your TV.

### Notes:

- Refer to your AV Receiver's manual for more information on connecting your speakers and other devices.
- Use your AV Receiver's remote to switch to the different devices you have connected.
- Some AV Receivers may not respond when the V3 Smart Input function is turned on.
- Your AV Receiver's signal priority in order is Component, S-VIDEO and Composite.

# Connecting Your Devices

## Connect a Computer

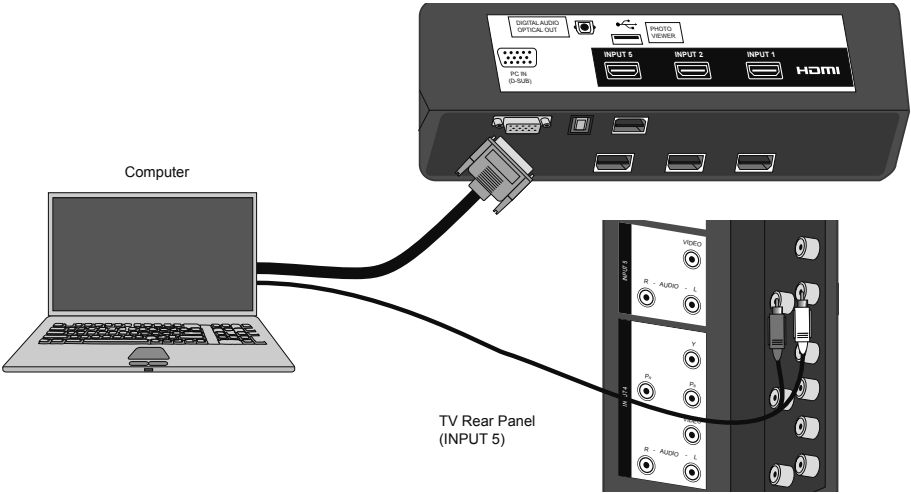

**Notes:**

- Make sure your TV is displaying INPUT 5 by pressing the **V5** button on your remote control.
- When you do the above connection, set “**Video-5 Input**” in the **Features** menu to “D-Sub”. See page 39.
- Use a D-SUB cable with ferrite cores and no longer than 3 Meters to avoid electromagnetic disturbances.
- Refer to your computer’s manual for more information.

Resolution	Vertical Frequency (Hz)	Horizontal Frequency (kHz)
640 x 480 (VGA)	60	31.5
800 x 600 (SVGA)	60	37.9
1024 x 768 (XGA)	60	48.4

**Notes:**

- Depending on signal quality, some pictures may not be displayed correctly.
- Computers that cannot set the refresh rate to 60 Hz, cannot be used with this TV.
- If you are inputting a PC signal that is invalid, “Invalid Signal” will appear on the TV screen. It appears when the input is PC and it is a single screen.

# Programming Your Remote

You can program your remote control to operate your external devices, using the instructions and codes on pages 55 - 61.

## How to set the codes

- 1) Manually turn on the device.
- 2) Change the remote control mode according to the device by pressing the **MODE** button. Refer to the following list for which mode to use.
- 3) Find the remote control code for your device. See pages 57 - 61.
- 4) Set the remote code.

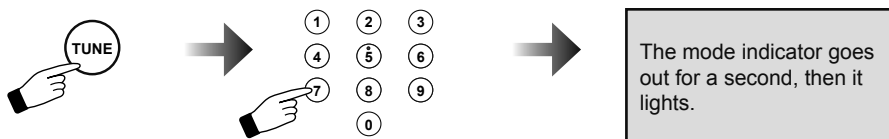

Press and hold

Enter the four digit number

- 5) Point the remote at the device and press power. If your device did not turn off or respond, try another code.

### Notes:

- If your device doesn't respond to any of the codes listed or is not listed, see page 55.
- Some codes may have only limited functions. Try other codes that may have more functions.

## Search Code Function

This function searches for codes one by one if none of the codes listed for your device has worked.

- 1) Manually turn on the device.
- 2) Change the remote control mode according to the device. Press **MODE** to select the correct mode.
- 3) Activate the search code function. Press and hold **POWER** and **RETURN+/TV** until the mode indicator blinks.
- 4) Point the remote at the device and press **POWER**. If no response, try the next code by pressing **▶** and **POWER** until the device turns off.
- 5) Press **RETURN+/TV** to register and set the code. Then the **MODE** indicator light goes out.

### Notes:

- If your remote still doesn't work with the "Search Code Function", use the remote that came with your device. Your TV remote can not be guaranteed to work with all devices, modes or operations.

# Programming Your Remote

Device	Applied for these devices
TV	JVC brand only
STB	Cable Set Top Boxes, Cable/PVR Combinations, Satellite Set Top Box, DBS/PVR Combination
VCR	VCR, DBS/PVR Combination, PVR, DVD/PVR Combination
DVD	DVD Player, DVD Recorder, Home Theater in a Box, Receiver
AUDIO	Amplifier, Home Theater in a Box, Receiver

## Remote Control Functions



**Turns the selected device off**



**Changes the remote control mode**

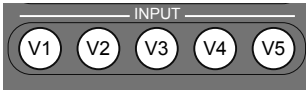

**Audio Input Selection**

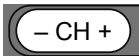

**Channel Up / Down**



**Displays Subtitles**



**Volume Up / Down**



**Open / Close**

### Operates menus

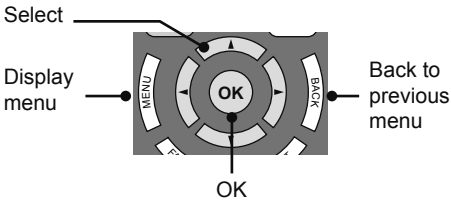

### Playback / Record, etc.

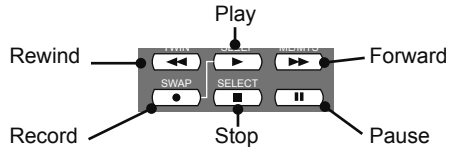

### Note:

- If your external devices has a TV/VCR function, refer to it's manual.



# Programming Your Remote

## Programming Codes

STB mode					
Cable Set Top Box		Satellite Set Top Box		Satellite Set Top Box	
ABC	0003, 0008	AlphaStar	0772	Samsung	1377, 1276, 1108,
Americast	0899	Chaparral	0216		1109, 1442, 1609
Bell South	0899	Coolsat	1806	SKY	0856
Digeo	1187	Crossdigital	1109	Sony	0639, 1639, 1640
Director	0476	DirecTV	1377, 0392, 0566,	Star Choice	0869
General Instrument	0476, 0810, 0276, 0003		0639, 1639, 1142,	Tivo	1142, 1442
			0247, 0749, 1749,	Toshiba	0749, 1749, 0790,
GoldStar	0144		0724, 0819, 1856,		1285
Hamlin	0009, 0273		1076, 1108, 0099,	UltimateTV	1392, 1640
Jerrold	0476, 0810, 0276, 0003		1109, 1414, 1442,	Ultrasat	1806
			1609, 1392, 1640	Uniden	0724, 0722
Memorex	0000	Dish Network System	1505, 1005, 0775,	US Digital	1535
Motorola	1376, 0476, 0810, 0276, 1187		1170, 1775	USDTV	1535
Pace	1877, 0237, 0008	Dishpro	1505, 1005, 0775,	Voom	0869
Panasonic	0000, 0008, 0107		1775	Zenith	0856, 1856
Paragon	0000	EchoStar	1505, 1005, 0775,	<b>DBS/PVR Combination</b>	
Philips	1305, 0317, 0025		1170, 1775		
Pioneer	1877, 0877, 0144, 0533	Expressvu	0775, 1775	DirecTV	1377, 0392, 0639,
		GE	0566		1142, 1076, 0099,
		General Instrument	0869		1392, 1442, 1640
Pulsar	0000	GOI	0775, 1775	Dish Network System	1505, 0775
Quasar	0000	Hisense	1535	Dishpro	1505, 0775
Regal	0279, 0273	Hitachi	0819	EchoStar	1505, 0775, 1170
Runco	0000	HTS	0775, 1775	Expressvu	0775
Samsung	0000, 0144	Hughes Network Systems	1142, 0749, 1749,	Hughes Network Systems	1142, 1442
Scientific Atlanta	1877, 0877, 0477, 0008		1442	JVC	1170
		Humax	1790	Motorola	0869
Sony	1006	iLo	1535	Philips	1142, 0099, 1442
Starcom	0003	JVC	0775, 1170, 1775	Proscan	0392
Supercable	0276	LG	1414	RCA	1392
Torx	0003	Magnavox	0724, 0722	Samsung	1442
Toshiba	0000	Memorex	0724	Sony	0639, 1640
Zenith	0000, 0525, 0899	Mitsubishi	0749	Star Choice	0869
		Motorola	0869		
<b>Cable/PVR Combination</b>		Next Level	0869		
		Panasonic	0247, 0701		
Americast	0899	Pansat	1807		
Digeo	1187	Paysat	0724		
General Instrument	0810	Philips	1142, 0749, 1749,		
Jerrold	0810		0724, 1076, 0722,		
Motorola	1376, 0810, 1187		0099, 1442		
Pace	1877, 0237	Proscan	0392, 0566		
Pioneer	1877, 0877	Proton	1535		
Scientific Atlanta	1877, 0877	RadioShack	0869		
Sony	1006	RCA	0566, 0855, 0143,		
Supercable	0276		1392		
Zenith	0899				

# Programming Your Remote

VCR mode		
VCR	VCR	VCR
ABS	1972	Fisher 0047, 0104, 0046
Admiral	0048, 0209	Fuji 0035, 0033
Adventura	0000	Funai 0000, 0593, 1593
Aiko	0278	Garrard 0000
Aiwa	0037, 0000, 0307, 0479	Gateway 1972
Akai	0041, 0061, 0106	GE 0060, 0035, 0240, 0202, 0760, 0761, 0807, 1035, 1060
Alienware	1972	Go Video 0432, 0526
America Action	0278	GoldStar 0037, 0209, 0038, 0225, 1237
American High	0035	
Asha	0240	
Audiovox	0037, 0278	Gradiente 0000
Beaumarck	0240	Harley Davidson 0000
Bell & Howell	0104	Harman/Kardon 0081, 0038
Broksonic	0184, 0121, 0209, 0002, 0479, 1479	Hanwood 0072
Calix	0037	Headquarter 0046
Canon	0035	Hewlett Packard 1972
Capehart	0020	HI-Q 0047
Carver	0081	Hitachi 0037, 0240, 0000, 0042, 0041, 0105, 1037
CCE	0072, 0278	
Citizen	0037, 0278, 1278	Howard Computers 1972
Colt	0072	HP 1972
Craig	0037, 0047, 0240, 0072, 0271	Hughes Network Systems 0042, 0739
Curtis Mathes	0060, 0035, 0162, 0041, 0760, 1035	Humax 0739
Cybernex	0240	Hush 1972
CyberPower	1972	IBUYPOWER 1972
Daewoo	0045, 0104, 0278, 0020, 0046, 0561, 1278	Jensen 0041
Daytron	0020	JVC 0045, 0067, 0041, 0008, 0366, 1707, 1945, 1774, 1775, 1776, 1777
Dell	1972	KEC 0037, 0278
Denon	0042	Kenwood 0067, 0041, 0038
DirectTV	0739	KLH 0072
Durabrand	0039, 0038	Kodak 0035, 0037
Dynatech	0000	LG 0037, 0045, 0042, 0209, 0038, 1037
Electrohome	0037	Linksys 1972
Electroponic	0037	Lloyd's 0000, 0208
Emerex	0032	Logik 0240, 0072
Emerson	0035, 0037, 0184, 0240, 0045, 0000, 0121, 0043, 0209, 0002, 0278, 1593, 1479, 1278, 0593, 0561, 0479, 0208, 0061	LXI 0037
		Magnasonic 0593, 1278
		Magnavox 0035, 0039, 0081, 0000, 0149, 0563, 0593, 1593, 1781
		Magnin 0240
		Marantz 0035, 0081
		Marta 0037
		Matsushita 0035, 0162, 0227, 1162
		Media Center PC 1972
		MEI 0035
		Memorex 0035, 0162, 0037, 0048, 0039, 0047, 0240, 0000, 0104, 0209, 0046, 0307, 0479, 1037, 1048, 1162, 1237, 1262
		MGA 0240, 0043, 0061
		MGN Technology 0240
		Microsoft 1972
		Mind 1972
		Minolta 0042, 0105
		Mitsubishi 0081, 0067, 0043, 0041, 0061, 0173, 0807
		Motorola 0035, 0048
		MTC 0240, 0000
		Multitech 0000, 0072
		NEC 0035, 0037, 0048, 0104, 0067, 0041, 0038, 0008
		Nikko 0037
		Niveus Media 1972
		Noblex 0240
		Northgate 1972
		Olympus 0035
		Optimus 1062, 0162, 0037, 0048, 0104, 0432, 0593, 1048, 1162, 1262
		Orion 0184, 0121, 0209, 0002, 0208, 0479, 1479
		Panasonic 1062, 0035, 0162, 0225, 0227, 0616, 1035, 1162, 1262
		Penney 0035, 0037, 0240, 0042, 0038, 1035, 1237
		Pentax 0042, 0105
		Philco 0035, 0000, 0038

# Programming Your Remote

VCR mode						
VCR		VCR		PVR		
Philips	0035, 0081, 0000,	Symphonic	0000, 0593, 1593	Howard Computers	1972	
	0563, 0593, 0618,	Systemax	1972	HP	1972	
	0739, 1081, 1181,	Tagar Systems	1972	Hughes Network Systems	0739	
	1266	Tatung	0081, 0045, 0000,	Humax	0739	
Pilot	0037		0067, 0041, 0008,	Hush	1972	
Pioneer	0081, 0042, 0067		0366	iBUYPOWER	1972	
Polk Audio	0081	Teac	0000, 0041	JVC	1945	
Portland	0020	Technics	0035, 0162	Linksys	1972	
Presidian	1593	Teknika	0035, 0037, 0000	Media Center PC	1972	
Profitronic	0240	Thomas	0000	Microsoft	1972	
Proscan	0060, 0202, 0760,	Tivo	0618, 0636, 0739,	Mind	1972	
	0761, 1060			Niveus Media	1972	
Protec	0072	TMK	0240, 0208	Northgate	1972	
Pulsar	0039	Toshiba	0081, 0045, 0042,	Panasonic	0616, 1777	
Quarter	0046			0067, 0043, 0041,	Philips	0618, 0739
Quartz	0046			0008, 0057, 0366,	RCA	0880
Quasar	0035, 0162, 1035,			0845, 1008, 1145,	ReplayTV	0614, 0616
	1162	1972, 1996	Samsung	0739		
RadioShack	0000, 1037	Totevision	0037, 0240	Sonic Blue	0614, 0616	
Radix	0037	Touch	1972	Sony	0636, 1972	
Randex	0037	Unitech	0240	Stack 9	1972	
RCA	0060, 0035, 0240,	Vector	0045	Systemax	1972	
	0000, 0042, 0149,	Vector Research	0038	Tagar Systems	1972	
	0105, 0106, 0202,	Video Concepts	0045, 0061	Tivo	0618, 0636, 0739	
	0760, 0761, 0807,	Videomagic	0037	Toshiba	1008, 1972, 1996	
	0880, 1035, 1060	Videosonic	0240	Touch	1972	
Realistic	0035, 0037, 0048,	Viewsonic	1972	Viewsonic	1972	
	0047, 0000, 0104,	Villain	0000	Voodoo	1972	
	0046	Voodoo	1972	ZT Group	1972	
ReplayTV	0614, 0616	Wards	0060, 0035, 0048,	<b>DVD/PVR Combination</b>		
Ricavision	1972		0047, 0081, 0240,			
Runco	0039		0000, 0042, 0072,			
Samsung	0240, 0045, 0432,		0149, 0760			Emerson
	0739, 0760, 1014	White Westinghouse	0209, 0072			
Sanky	0048, 0039	XR-1000	0035, 0000, 0072			
Sansui	0000, 0067, 0209,	Yamaha	0041, 0038			
	0041, 0271, 0479,	Zenith	0039, 0033, 0000,			
Sanyo	1479	0209, 0034, 0479,	1139, 1479			
	0047, 0240, 0104,	ZT Group	1972			
Scott	0184, 0045, 0121,	<b>DBS/PVR Combination</b>				
	0043	EchoStar	1945			
Sears	0035, 0037, 0047,	Hughes Network Systems	0739			
	0000, 0042, 0104,	JVC	1945			
	0046, 0057, 0105,	Philips	0739			
Sharp	1237	Samsung	0739			
	0048, 0209, 0807,	<b>PVR</b>				
Shintom	0848, 1048	ABS	1972			
	0104, 0072	Alienware	1972			
Shogun	0240	CyberPower	1972			
Singer	0045, 0072	Dell	1972			
Sonic Blue	0614, 0616	DirecTV	0739			
Sony	0035, 0032, 0033,	Dish Network System	1945			
	0000, 0034, 0636,	EchoStar	1945			
0639, 0640, 1032,	Gateway	1972				
1232, 1972	Hewlett Packard	1972				
Stack 9	1972					
STS	0042					
Sylvania	0035, 0081, 0000,					
	0043, 0593, 1593,					
1781						

# Programming Your Remote

DVD mode					
DVD		DVD		DVD Recorder	
Accurian	1416	Magnavox	0503, 0539, 0646,	Accurian	1416
Advent	1016		0675, 0821, 1268	Apex Digital	1056
Aiwa	0641	Marantz	0539	Aspire Digital	1168
Akai	0695, 0770, 0899	Memorex	0695, 0831, 1270	CyberHome	1129
Alco	0790	Microsoft	0522, 1708	Denon	0490
Allegro	0869	Mintek	0839, 0717	Funai	0675, 1334
Apex Digital	0672, 0717, 0755,	Mitsubishi	1521, 0521	Gateway	1158
	0830, 1056, 1061		NAD	0741	Go Video
Arrgo	1023	NEC	0785		1730
Aspire Digital	1168	Nesa	0717	iLo	1348
Audiovox	0790	NexxTech	1402	JVC	1164
Blaupunkt	0717	Norcent	1003, 1107	LG	0741
Blue Parade	0571	Onkyo	0503, 0627	LiteOn	1158, 1416, 1440
Broksonic	0695	Oritron	0651	Magnavox	0646, 0675
Cinea	0831	Panasonic	0490, 0703, 1362,	Panasonic	0490
Cine Vision	0876, 0833, 0869		1462, 1490, 1762	Philips	0646, 1158
Citizen	1277	Philips	0503, 0539, 0646,	Pioneer	0631
Coby	0778, 1107		0675, 0854, 1158,	RCA	0522
Craig	0831		1260, 1267, 1354	Samsung	0490, 1470
Curtis Mathes	1087	Pioneer	0525, 0571, 0631	Sensory Science	1158
CyberHome	0816, 0874, 1023,	Polaroid	1061	Sharp	0630, 0675
	1024, 1117, 1129	Polk Audio	0539	Sony	1033, 1431
Daewoo	0784, 0705, 0770,	Portland	0770	Sylvania	0675
	0833, 0869, 1169,	Presidian	0675	Zenith	0741
	1172	Prima	1016		
	Denon	0490, 0634	Proscan	0522	
Disney	0675, 1270	Pro Vision	0778	<b>Home Theater in Box</b>	
Durabrand	1127	Qwestar	0651	Aiwa	0641
DVD2000	0521	RCA	0522, 0571, 0717,	Audiovox	0790
Emerson	0591, 0675, 0821,		0790, 0822, 1022,	JVC	1770, 1771, 1772,
	1268		1132		1773
Enterprise	0591	Rio	0869	KLH	0790
ESA	0821, 1268	Rotel	0623	Koss	0651
Fisher	0670	Sampo	0752	Oritron	0651
Funai	0675, 1268, 1334	Samsung	0490, 0573, 0744,	Polk Audio	0539
Gateway	1158		0820, 0899, 1044,	RCA	0790
GE	0522, 0815, 0717		1075, 1470	Rio	0869
Go Video	0744, 0715, 0741,	Sansui	0695	Sonic Blue	0869
	0783, 0833, 0869,	Sanyo	0670, 0695, 0873	Teac	0790
	1044, 1075, 1099,	Sensory Science	1158	Venturer	0790
	1158, 1304, 1730	Sharp	0630, 0675, 0752,		
GoldStar	0741		1256		
Greenhill	0717	Sharper Image	1117		
Harman/Kardon	0582, 0702	Sherwood	0770		
Hitachi	0573, 0664, 1247	Shinonic	0533, 0839		
Hiteker	0672	Sonic Blue	0869, 1099		
Humax	1500, 1588	Sony	0533, 1533, 0864,		
iLo	1348		1033, 1431, 1536		
Initial	0717	Superscan	0821		
Insignia	1268	Sylvania	0675, 0821, 1268		
Integra	0627	Symphonic	0675, 0821		
JBL	0702	Teac	0717, 0790		
Jensen	1016	Technics	0490, 0703		
JVC	0558, 0623, 0867,	Theta Digital	0571		
	1164, 1602, 1770,	Tivo	1503		
	1771, 1772, 1773	Toshiba	0503, 0695, 1045,		
Kawasaki	0790		1154, 1503, 1515,		
Kenwood	0490, 0534		1588		
KLH	0717, 0790, 1149	Urban Concepts	0503		
Koss	0651	US Logic	0839		
Lasonic	0798	Venturer	0790		
Lenoxx	1127	Xbox	0522, 1708		
LG	0591, 0741, 0869	Yamaha	0490, 0539, 0545		
LiteOn	1058, 1158, 1416,	Zenith	0503, 0591, 0741,		
	1440		0869		



# Troubleshooting

Refer to the table below to check the condition. If you think that there is a problem, contact the JVC Service Center where you purchased the television.

PROBLEMS	CHECK
There is no power	<ul style="list-style-type: none"> <li>• See if the power cord became unplugged.</li> <li>• Check for a blown fuse or circuit breaker or a power outage.</li> </ul>
There is no picture or sound	<ul style="list-style-type: none"> <li>• The antenna could be disconnected.</li> <li>• The tuner could be set improperly. See page 25.</li> <li>• The TV station may be having difficulties. Check to see if other stations are working.</li> <li>• Use the HDMI cable with HDMI logo <b>HDMI</b>. See page 52.</li> <li>• You cannot output audio using the DIGITAL AUDIO OPTICAL OUTPUT when you have digital sound from an HDMI device connected to the INPUT-1, INPUT-2 or INPUT-5 connection on the back of the TV.</li> <li>• This TV can accept 480i (Composite / S / HDMI / Component), 480p, 720p, 1080i and 1080p signals. Please check your settings.</li> </ul>
Remote control is not operating properly or at all	<ul style="list-style-type: none"> <li>• Check to see that the batteries are still working and properly installed.</li> <li>• Make sure the remote has a clear sight path to the TV.</li> <li>• You may be too far from the TV. You must be within 23 feet (7 meters).</li> <li>• Make sure nothing is connected to the IR IN terminal except for an IR device.</li> </ul>
The power turns off by itself	<ul style="list-style-type: none"> <li>• Make sure the set did not become unplugged.</li> <li>• Perhaps the Auto Shut Off is set. See page 33.</li> <li>• Check to see if the Sleep Timer was set. See page 43.</li> </ul>
It does not operate correctly	<ul style="list-style-type: none"> <li>• This television is operated by a microprocessor. It is possible that external noise or interference is causing the problem. If the television does not function correctly, remove the electrical plug from the wall outlet and wait a while before inserting it into the wall outlet again and operating the television.</li> </ul>
The color quality is poor	<ul style="list-style-type: none"> <li>• Tint and Color may be improperly adjusted. See page 34.</li> <li>• The Video Status mode may be turned to the wrong setting. See page 34.</li> </ul>
There are lines across the picture	<ul style="list-style-type: none"> <li>• There could be interference from another electrical appliance, such as a computer, another TV or VCR. Move any such appliances further away from the TV.</li> </ul>
The picture is spotted	<ul style="list-style-type: none"> <li>• There could be interference from a high-wattage appliance, like a hairdryer or vacuum, operating nearby. Move the antenna away from the appliance or change to a coaxial cable connection which is less prone to interference.</li> </ul>
There are double pictures (ghosts)	<ul style="list-style-type: none"> <li>• A building or passing airplane can reflect the original signal and produce a second, slightly delayed one. Adjust your antenna position.</li> </ul>
Picture is snowy (image noise)	<ul style="list-style-type: none"> <li>• Your antenna may be damaged, disconnected or turned. Check the antenna connection. If the antenna is damaged, replace it.</li> </ul>

# Troubleshooting

PROBLEMS	CHECK
Screen is 80% black	<ul style="list-style-type: none"> <li>The Closed Caption Text mode is on. Turn it off in the Closed Caption Menu, page 32.</li> </ul>
Stereo or bilingual programs can't be heard	<ul style="list-style-type: none"> <li>Make sure the MTS settings are correct. See page 23.</li> </ul>
Static electricity	<ul style="list-style-type: none"> <li>It is normal to feel static electricity if you brush or touch the screen.</li> </ul>
You hear occasional crackling sounds	<ul style="list-style-type: none"> <li>It is normal for the TV to make crackling sounds when first turned on or off. Unless the sound or picture become abnormal, this is fine.</li> </ul>
The screen disappears except for the menu screen	<ul style="list-style-type: none"> <li>This occurs when you select a digital menu when your input source is from the HDMI connection. Press the menu button.</li> </ul>
My HDMI device doesn't work or doesn't work properly	<ul style="list-style-type: none"> <li>Please use a High Speed HDMI™ Cable. High Speed HDMI™ Cables are tested to carry an HD signal up to 1080p and higher.</li> </ul>
"Weak Signal" appears	<ul style="list-style-type: none"> <li>This OSD appears when the digital channel that you have selected is too weak to receive or no signal is being detected for that channel.</li> </ul>
"No Program" appears	<ul style="list-style-type: none"> <li>It appears when that channel is not receiving a signal and you have the Noise Muting function OFF and you have a single screen. It moves automatically every two seconds to prevent the screen from burn-in.</li> <li>Even if "NO PROGRAM" appears on the screen, your timer functions and auto shut off functions that you set, are still active.</li> <li>If you are watching an analog channel, NO PROGRAM does not appear.</li> </ul>

## The following are not malfunctions.

- The television may make a creaking sound if the temperature of the room or the temperature of the inside of the television changes. If there is no problem with the screen or sound, then there is no need to worry.
- The picture may be temporarily disturbed and noise may be seen on the screen if the power is turned on immediately after it has been turned off. This is not a malfunction.

# Specifications

Model	LT-42X899	LT-47X899
Type	LCD Flat Television	
Reception Format	NTSC, BTSC System (Multi-Channel Sound) ATSC Terrestrial, Digital Cable	
Reception Range	VHF 2 to 13, UHF 14 to 69 at ATSC, CATV 135 Sub, Mid, Super, Hyper and Ultra bands at Digital Cable	
	VHF 2 to 13, UHF 14 to 69 CATV 135 Sub, Mid, Super, Hyper and Ultra bands (191 channel frequency synthesizer system) at Analog • Reception of channel A-5 ("95" of the TV set's on-screen cable channel numbers) is not recommended for your TV set.	
Power Source	AC 120V, 60 Hz	
Power Consumption	229W	299W
Screen Size	42 inch / 106.7 cm measured diagonally, 16:9 ratio	47 inch / 119.4 cm measured diagonally, 16:9 ratio
Audio Output	10W + 10W	
Speakers	4.5 x 16cm Twin Oblique Cone x 2	
Antenna Terminal (VHF/UHF, ATSC/DIGITAL CABLE IN)	75 ohms (VHF/UHF)(F-type connector)	
Input 3, 4, 5 Terminal (Composite Terminal)	480i S (Input 4) Y: 1 Vp-p positive, 75 ohms (negative sync provided) C: 0.286 Vp-p (burst signal), 75 ohms Video: 1 Vp-p, 75 ohms Audio: 500 mVrms (-4dBs) high impedance	
Input 3, 4 Terminal (Component Terminal)	1080i / 720p / 480p / 480i Y: 1 Vp-p positive, 75 ohms (negative sync provided) Pb/Pc: 0.7 Vp-p 75 ohms	
Input 1, 2, 5 Terminal (HDMI Input Terminal)	Video: 1080/60p / 1080/30p / 1080/24p / 1080i / 720p / 480p / 480i Audio: 2ch PCM, 32 / 44.1 / 48 KHz 16 / 20 / 24 bit	
PC Input Jacks	Analog RGB D-SUB (15 pin) x 1	
Audio Output Jacks (FIX)	FIX : 500mVrms (-4dBs), Low Impedance	
Optical Output Digital Audio	Digital Out (optical) x 1	
Dimensions (inch/mm) W X H X D	39 3/4 x 27 7/8 x 11 3/4 (with stand) 1007 x 707.2 x 296 (with stand)	44 1/4 x 30 1/2 x 11 3/4 (with stand) 1121 x 773.7 x 296 (with stand)
	39 3/4 x 26 x 5 1/8 (without stand) 1007 x 660 x 129.1 (without stand)	44 1/4 x 28 5/8 x 5 1/8 (without stand) 1121 x 726.5 x 129.8 (without stand)
Weight (lbs / kg)	59.4 / 27 (with stand)	74.8 / 34 (with stand)
	44 / 25 (without stand)	66 / 30 (without stand)

Specifications subject to change without notice.



# Warranty

Notice for USA customers – Models LT-42/47X899  
This 2 year limited warranty supersedes the 1 year limited warranty accompanying this product.

\*\*\*\*\*

**JVC** **LIMITED WARRANTY** **2-2 USA ONLY**

**ONLY FOR PRODUCT PURCHASED IN U.S.A.**

PARTS	LABOR
<b>2 YRS</b>	<b>2 YRS</b>

**THIS LIMITED WARRANTY IS VALID ONLY IN THE FIFTY (50) UNITED STATES, THE DISTRICT OF COLUMBIA AND IN THE COMMONWEALTH OF PUERTO RICO.**

**WHAT WE WILL DO:**  
If this product is found to be defective within the warranty period, JVC will repair or replace defective parts with new or rebuilt equivalents at no charge to the original owner. Such repair and replacement services shall be rendered by JVC during normal business hours at JVC authorized service centers. Parts used for replacement are warranted only for the remainder of the Warranty Period. All products may be brought to a JVC authorized service center on a carry-in basis. Color televisions with a screen size of 27" or greater qualify for in-home service. In such cases, a technician will come to your home and either repair the TV there or remove and return it if it cannot be repaired in your home.

**WHAT YOU MUST DO FOR WARRANTY SERVICE:**  
*Please do not return your product to the retailer*  
Instead, return your product to the JVC authorized service center nearest you. If shipping the product to the service center, please be sure to package it carefully, preferably in the original packaging, and include a brief description of the problem(s). Please call 1-800-252-5722 to locate the nearest JVC authorized service center. Service locations can also be obtained from our website <http://www.jvc.com>. If your product qualifies for in-home service, the service representative will require clear access to the product.

If you have any questions concerning your JVC Product, please contact our Customer Care Center at 800-252-5722

- WHAT IS NOT COVERED:**  
This limited warranty provided by JVC does not cover:
1. Products which have been subject to abuse, accident, alteration, modification, tampering, negligence, misuse, faulty installation, lack of reasonable care, or if repaired or serviced by anyone other than a service facility authorized by JVC to render such service, or if affixed to any attachment not provided with the products, or if the model or serial number has been altered, tampered with, defaced or removed;
  2. Initial installation, installation and removal from cabinets or mounting systems.
  3. Operational adjustments covered in the Owner's Manual, normal maintenance, video and audio head cleaning;
  4. Damage that occurs in shipment, due to act of God, and cosmetic damage;
  5. Signal reception problems and failures due to line power surge;
  6. User Removal Memory Devices/Video Pick-up Tubes/CCD Image Sensors are covered for 90 days from the date of purchase;
  7. Accessories;
  8. Batteries (except that Rechargeable Batteries are covered for 90 days from the date of purchase);
  9. Products used for commercial purposes, including, but not limited to rental.
  10. Loss of data resultant from malfunction of hard drive or other data storage device;
- There are no express warranties except as listed above.

**THE DURATION OF ANY IMPLIED WARRANTIES, INCLUDING THE IMPLIED WARRANTY OF MERCHANTABILITY, IS LIMITED TO THE DURATION OF THE EXPRESS WARRANTY HEREIN.**

**JVC SHALL NOT BE LIABLE FOR ANY LOSS OF USE OF THE PRODUCT, INCONVENIENCE, OR ANY OTHER DAMAGES, WHETHER DIRECT, INCIDENTAL OR CONSEQUENTIAL (INCLUDING, WITHOUT LIMITATION, DAMAGE TO TAPES, RECORDS OR DISCS) RESULTING FROM THE USE OF THIS PRODUCT, OR ARISING OUT OF ANY BREACH OF THIS WARRANTY. ALL EXPRESS AND IMPLIED WARRANTIES, INCLUDING THE WARRANTIES OF MERCHANTABILITY AND FITNESS FOR PARTICULAR PURPOSE, ARE LIMITED TO THE WARRANTY PERIOD SET FORTH ABOVE.**

Some states do not allow the exclusion of incidental or consequential damages or limitations on how long an implied warranty lasts, so these limitations or exclusions may not apply to you. This warranty gives you specific legal rights and you may also have other rights which vary from state to state.

**JVC AMERICAS CORP.**  
1700 Valley Road, Wayne, New Jersey 07470  
<http://www.jvc.com>

\*\*\*\*\*  
REFURBISHED PRODUCTS CARRY A SEPARATE WARRANTY, THIS WARRANTY DOES NOT APPLY. FOR DETAIL OF REFURBISHED PRODUCT WARRANTY, PLEASE REFER TO THE REFURBISHED PRODUCT WARRANTY INFORMATION PACKAGED WITH EACH REFURBISHED PRODUCT.

**For customer use:**  
Enter below the Model No. and Serial No. which is located either on the rear, bottom or side of the cabinet. Retain this information for future reference.

Model No. :	Serial No. :
Purchase date :	Name of dealer :

# Warranty

## **TO OUR VALUED CUSTOMER** ———

THANK YOU FOR PURCHASING THIS JVC PRODUCT.  
WE WANT TO HELP YOU ACHIEVE A PERFECT EXPERIENCE.

**NEED HELP ON HOW TO HOOK UP?  
NEED ASSISTANCE ON HOW TO OPERATE?  
NEED TO LOCATE A JVC SERVICE CENTER?  
LIKE TO PURCHASE ACCESSORIES?**

**JVC<sup>®</sup> IS HERE TO HELP!**  
**TOLL FREE: 1(800)252-5722**  
**<http://www.jvc.com>**

Remember to retain your Bill of Sale for Warranty Service.

————— **Do not attempt to service the product yourself** —————

**Caution**

To prevent electrical shock, do not open the cabinet.  
There are no user serviceable parts inside.  
Please refer to qualified service personnel for repairs.

---

# Notes

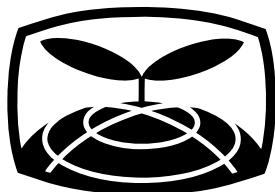

JVC Loves the Earth

## Digital Television Transition Notice:

This device contains a digital television tuner, so it should receive digital over the air TV programming, with a suitable antenna, after the end of full-power analog TV broadcasting in the United States on February 17, 2009.

Some older television receivers, if they rely on a TV antenna, will need a TV Converter to receive over the air digital programming, but should continue to work as before for other purposes (e.g., for watching low-power TV stations still broadcasting in analog, watching pre-recorded movies, or playing video games).

For more information, see <http://www.DTV.gov> or call 1-888-CALL-FCC. For converter box information, see <http://www.dtv2009.gov> or call the NTIA at 1-888-DTV-2009.

**JVC COMPANY OF AMERICA**  
Division of JVC Americas Corp.  
1700 Valley Road  
Wayne, New Jersey, 07470

**JVC**<sup>®</sup>

**JVC CANADA, INC.**  
21 Finchdene Square  
Scarborough, Ontario  
Canada, M1X 1A7