

WaveSurfer™ Accessory

LeCroy GP-EXT

EXTERNAL USB PRINTER User's Manual



LeCroy

WaveSurfer is a trademark of LeCroy Corporation.

Windows is a registered trademark or a trademark of Microsoft Corporation in the United States and other countries.

Foreword

- ◇ Thank you for purchasing LeCroy's EXTERNAL USB PRINTER (hereafter referred to as "EXTERNAL USB PRINTER" or "printer".)
- ◇ Before using this printer, please read this manual thoroughly to gain a good understanding of it. After reading, please keep the manual in a safe place.
- ◇ This manual describes notes on use and basic usage of the EXTERNAL USB PRINTER.

Notes

- ◇ Parts of the contents of this manual may be modified without prior notice because of improvements in performance and functions.
- ◇ Reproduction or reprinting of the contents of this manual without prior permission from LeCroy is prohibited.
- ◇ If you have questions about this printer, please contact LeCroy Corporation. (Refer to the contact address given at the end of this manual.)

Revision History

- ◇ December 2004 : 1st edition
- ◇ February 2005 : 2nd edition
- ◇ April 2005 : 3rd edition

Checking the Packing Content

On delivery of the printer, check each item. If any of the items are missing or there is any damage, immediately contact LeCroy or the sales office in charge.

[Items to be present]

- Printer main unit (EXTERNAL USB PRINTER) 1

Accessories

- DC cable..... 1
- USB cable..... 1
- Mount 1
- Mount mounting screw..... 1
- Thermal paper roll for printer* 1
- User's manual 1

* Thermal paper rolls for the printer are available at LeCroy Corporation or local sales dealer. Please contact LeCroy Corporation or local sales dealer when ordering thermal paper rolls.

Sending The Printer Back for Repairs

If the printer is inoperable, send it back to LeCroy Corporation. (Refer to the contact address given at the end of this manual.) We will repair it without charge as long as it is under warranty.

When sending back the printer, explicitly describe the following: product name, serial number, description of the trouble, name/post/phone number of the contact person.

Table of Contents

■ Safety Requirements.....	1
■ Product Disposal and Recycling.....	3
■ Overview.....	4
■ Configuration.....	4
■ Units and Devices.....	5
(a) Printer.....	5
(b) DC Cable.....	6
(c) USB Cable.....	6
(d) Mount.....	7
■ Operating Procedures.....	8
(a) Attaching the Mounting Bracket to the Printer.....	8
(b) Mounting the Printer and Mounting Bracket onto the Rear of the WaveSurfer.....	9
(c) Connecting the DC Cable.....	11
(d) Connecting the USB Cable.....	12
(e) Loading the Printer Paper.....	13
(f) Add a printer.....	15
(g) Starting the Test Print.....	18
(h) Starting the Print-out.....	19
(i) Turning OFF the Printer.....	20
■ Indicators.....	21
■ Specifications.....	22
(a) Product Specifications.....	22
(b) Certifications.....	24

■ Safety Requirements

This section contains information and cautions that must be observed to keep the External USB Printer operating in a correct and safe condition. You are required to follow generally accepted safety procedures in addition to the safety precautions specified in this section.

Safety Symbols

The following symbols may appear on the product and they alert you to important safety considerations.



This symbol is used where caution is required. Refer to the accompanying information or documents in order to protect against personal injury or damage to the instrument.

CAUTION

The CAUTION sign indicates a potential hazard. It calls attention to a procedure, practice or condition which, if not followed, could possibly cause damage to equipment. If a CAUTION is indicated, do not proceed until its conditions are fully understood and met.

Before using this product, ensure that its operating environment will be maintained within these parameters:

Temperature: 0 to 40 °C

Humidity: 30%RH to 80%RH (non-condensing)

**CAUTION**

To avoid personal injury or damage to the External USB Printer or the WaveSurfer oscilloscope connected to it, review and comply with the following safety precautions.

- **Use only as intended.**
The External USB Printer is intended to be used only with the LeCroy WaveSurfer series oscilloscopes to print a hard copy of the screen image. Use of this product and/or the scope it is connected to in a manner other than specified may impair the protection mechanisms.
- **Connect and disconnect properly.**
Avoid damage to cables thru excessive bending.
Do not disconnect the DC cable and/or USB cable while printing. Doing so may cause the product to malfunction or the data to be corrupted.
- **For indoor use only.**
The printer is intended for indoor use and should be operated in a clean, dry, environment.
- **Do not operate with suspected failures.**
Do not use the printer if any part is damaged. All maintenance should be referred to qualified service personnel.
- **Refer to assembly instructions in the manual before mounting this product onto the rear of WaveSurfer oscilloscope.**
- **Always use the attached DC cable.**
If a cable other than that supplied is used, this may cause an electric shock, a fire, or a malfunction.
- **To ensure safety, turn OFF the Printer POWER, if it is not used for an extended period of time.**

- **Do not touch thermal head soon after printing. It may be hot.**
Ensure Thermal Head is cold before replacing paper roll or cleaning the head.
- **Keep product surfaces clean and dry.**

CLEANING

The outside of the printer hardware should be cleaned with a soft cloth dampened with either deionized / distilled water or isopropyl alcohol. Allow the surface to dry completely before returning the instrument to service.

USE AND MAINTENANCE

The printer is a high quality, precision instrument. To maintain accuracy, mechanical shock should be avoided, as well as damage to the cables through excessive bending. All maintenance and component replacement should be referred to qualified personnel.

■ Product Disposal and Recycling



This electronic product is subject to disposal and recycling regulations that vary by country and region. Many countries prohibit the disposal of waste electronic equipment in standard waste receptacles.

For more information about proper disposal and recycling of your LeCroy product, please visit www.lecroy.com/recycle.

■ Overview

This printer is a thermal line dot printer specially designed for the WaveSurfer-series.

The printer prints a hard copy of the screen of the WaveSurfer .

Power is supplied to this printer through the DC output of the WaveSurfer. The printer is connected to the USB connector of the WaveSurfer.

This printer can also be operated with the printer mounted on the rear of the WaveSurfer. This instruction manual describes how to mount the printer on the WaveSurfer, how to connect the printer to the WaveSurfer, and how to operate the printer.

■ Configuration

This printer can be operated mounted on rear of the WaveSurfer or unmounted. Reference Figure 1 for details on mounting. In either case, the DC cable is connected to the DC-OUT connector of the WaveSurfer to input the power to the DC INPUT connector of this printer. Figure 1 shows the printer connected to the WaveSurfer with the USB cable.

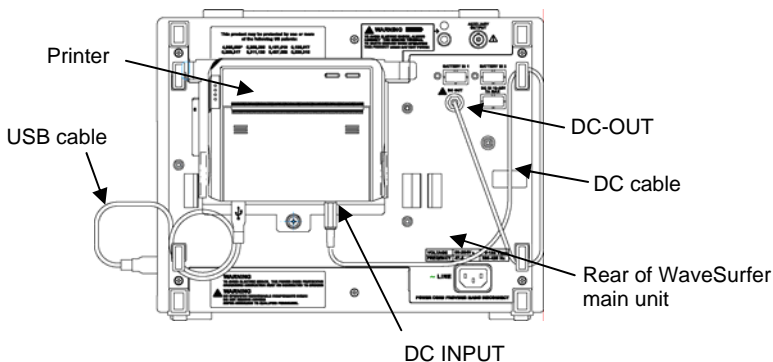

Figure 1 Printer Is Mounted on the Rear of the WaveSurfer

■ Units and Devices

(a) Printer

Figure 2 shows the outside view and dimensions of the printer.

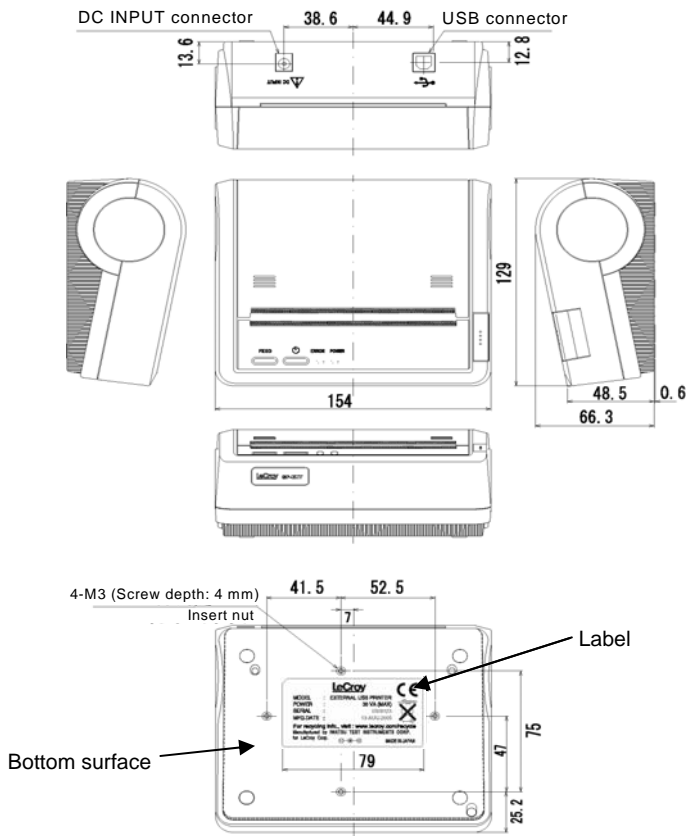

Figure 2 Outside View and Dimensions of Printer (in millimeters)

(b) DC Cable

Figure 3 shows the outside view and cable length of the DC cable.

**Figure 3 DC Cable****(c) USB Cable**

Figure 4 shows the outside view and cable length of the USB cable.

**Figure 4 USB Cable**

(d) Mount

Figure 5 shows the outside view and dimensions of the mount.

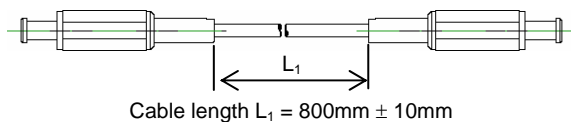
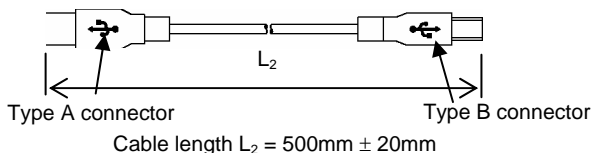
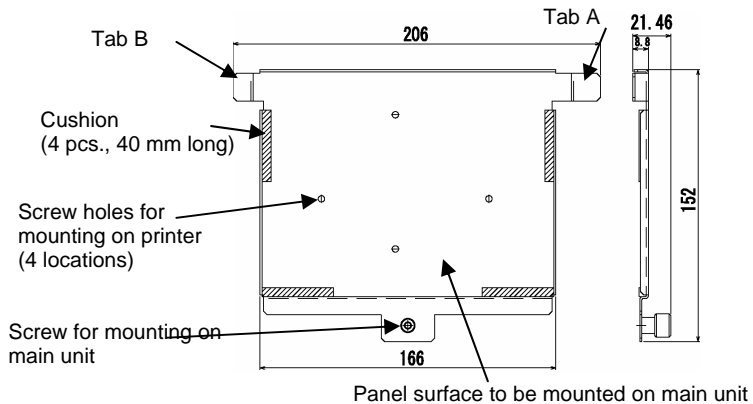

Figure 5 Mount

■ Operating Procedures

To operate this product, follow the steps below.

If you do not intend to mount the printer on the WaveSurfer DSO, start from Step (c).

(a) Attaching the Mounting Bracket to the Printer

The mounting bracket is used to mount the printer on the WaveSurfer DSO.

1. Place the mounting bracket on the bottom surface of the printer so that the surface with the cushion attached faces upward.

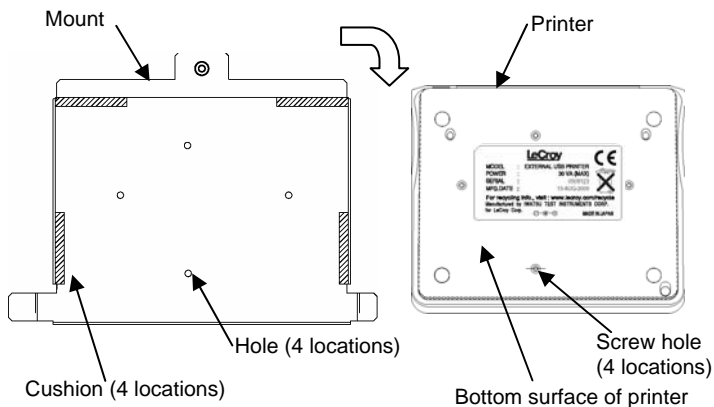

Figure 6 Mounting the Mount

2. Next, align the screw holes in the printer (4 locations) with the holes in the mounting bracket (4 locations).
3. Tighten the mounting bracket mounting screws (4 pcs.) with a Phillips screwdriver to secure the mounting bracket to the printer.

NOTE Tighten mounting screws evenly.

(b) Mounting the Printer and Mounting Bracket onto the Rear of the WaveSurfer

1. As shown in Figure 7, insert Tab A of the mounting bracket into Slot A at the rear of the WaveSurfer.



Figure 7 Mounting the Hook A of the Mounting Bracket

2. Next, match the Tab B of the mounting bracket with Slot B at the rear of the WaveSurfer, and then insert it by sliding it left.

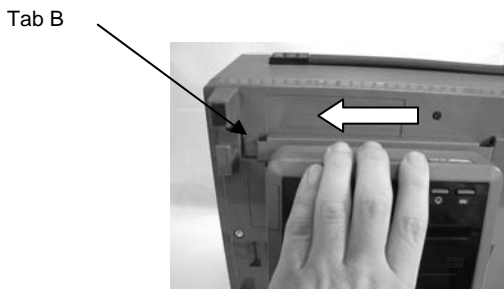

Figure 8 Inserting Tab B of the Mounting Bracket

3. Finally, tighten the mounting bracket captive screw at the rear.

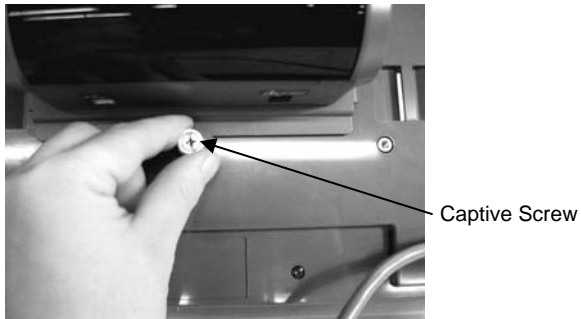

Figure 9 Tightening the Mounting Bracket Captive Screw

(c) Connecting the DC Cable

Generally, the power is supplied to the DC INPUT connector of the printer from the DC-OUT connector of the WaveSurfer through the DC cable.

Follow the steps below to connect the DC cable to the WaveSurfer.

1. Connect the DC cable to the DC INPUT connector of the printer.

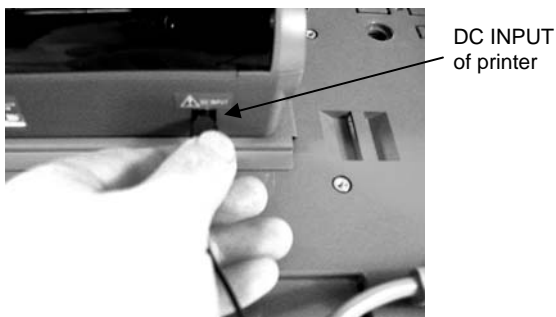

Figure 10 Connection of DC Cable to Printer

2. Next, connect the DC cable to the DC-OUT connector of the WaveSurfer.

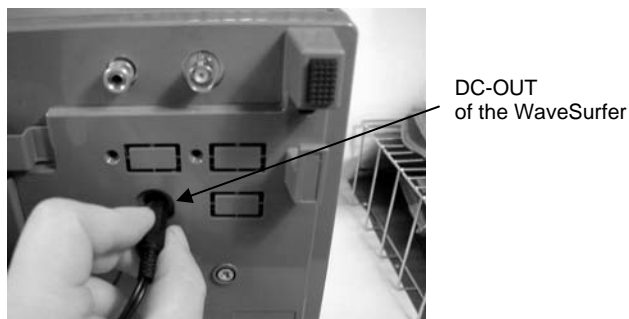

Figure 11 Connection of DC Cable to DC-OUT of WaveSurfer

(d) Connecting the USB Cable

One end of the USB cable has the TypeA connector while the other end has the TypeB connector.

1. Connect the TypeB connector of the USB cable to the USB connector of the printer.

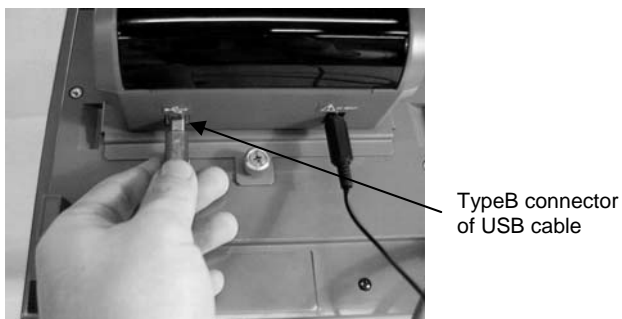

Figure 12 Connection of USB Connector (Printer Side)

2. Connect the TypeA connector of the USB cable to the USB connector of the WaveSurfer.

NOTE) A USB connector is provided on the front panel of the WaveSurfer (lower-right portion when viewed from the front) and on the side panel .

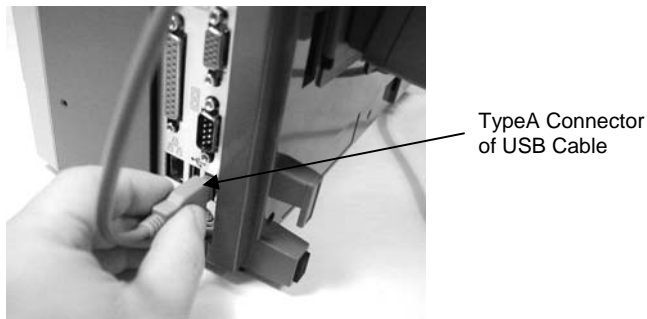

Figure 13 Connection of USB Connector (WaveSurfer Side)

(e) Loading the Printer Paper

1. Press the OPEN button on the printer to open the paper cover.
(See Figs. 14a and b.)

NOTE Press the OPEN button while holding the paper cover by hand.

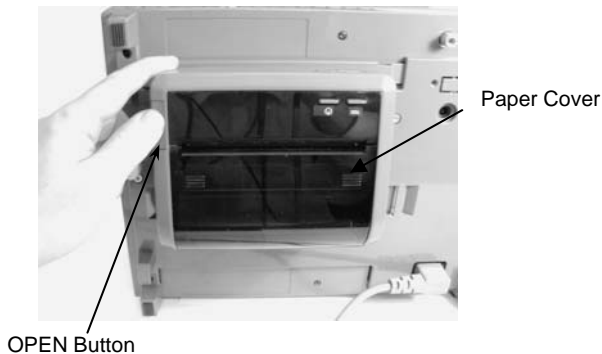

Figure 14a Opening the Paper Cover

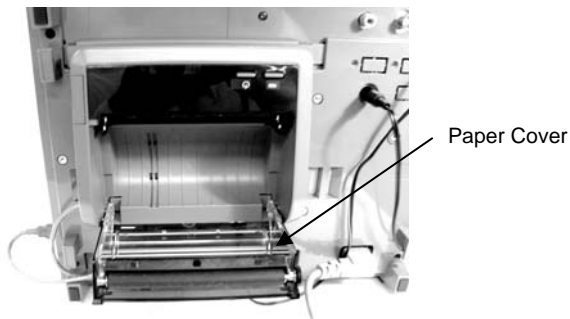

Figure 14b Paper Cover Open

2. Orient the thermal paper for the printer.

NOTE) Carefully check the top and bottom of the thermal paper, since printing cannot occur if the thermal paper is set upside-down.

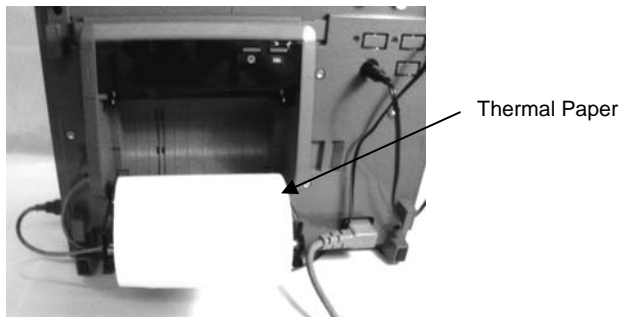

Figure 15 Thermal Paper for Printer

3. Feed the thermal paper so that the top end of the thermal paper roll is slightly projected from the printer.
As shown in Figure 16, press with both hands to close the paper cover.



NOTE Close the cover firmly until a click sounds.

Figure 16 Closing the Paper Cover

(f) Add a printer

Follow steps 1 to 7 of the "Setting Procedures" below.

In some WaveSurfer software vesions, the Found New Hardware Wizard window may not appear on the screen of the WaveSurfer in step 3 of the "Setting Procedures" below. If this is the case, disregard steps 3 to 6.

Start the application software on the WaveSurfer as described in step 7 of "Setting Procedures" below, and proceed with step (g) "Starting the Test Print" on page 15.

Setting Procedure.

1. Exit the application software on the WaveSurfer.
2. Turn on the Power Switch of the printer.
3. The following Found New Hardware Wizard window will appear on the screen of the WaveSurfer.

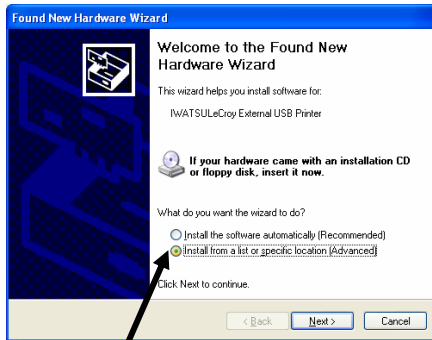

- (1) Check the radio button indicated by the arrow.
- (2) Click the "Next>" button at the bottom of the window.

4. The following window will appear on the screen of the WaveSurfer for specifying the driver installation location.

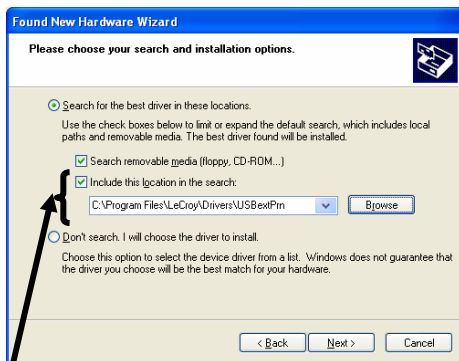

- (1) Mark the checkbox indicated by the arrow.
- (2) Click the "Browse" button on the right to specify the "C:\Program Files\LeCroy\Drivers\USBExtPrn" directory.
- (3) Click the "Next>" button at the bottom of the window.

5. If the following message appears during the operation, click the "Continue Anyway" button at the bottom of the window.



6. The following window will appear when the operation is successfully completed. Click the "Finish" button. This operation adds the printer to the WindowsXP.

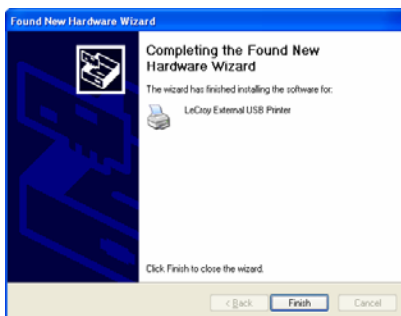

7. Click the "StartDSO" icon on the WaveSurfer desktop to launch the application software. This operation adds the printer to the application software.

(g) Starting the Test Print

1. Turn ON the POWER switch on the main unit to start it up.

NOTE: It is acceptable if the WaveSurfer is running.

2. Press the POWER switch on the printer while also pressing the FEED switch. (See Figure 17.)

3. The POWER lamp will light and the test print will start. (See Figure 17.)

During test printing, the printer built-in characters having a normal size and a double width size are printed in order.

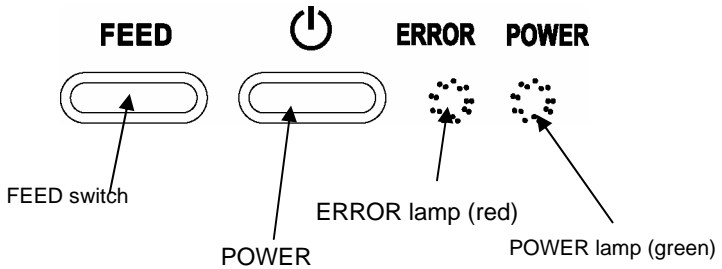

Figure 17 Switches and Lamps on Printer

(h) Starting the Print-out

A hardcopy of the screen on the WaveSurfer is printed out. The following describes the printing area.

- Strip chart: Prints out the waveform portion on the screen and the basic setup data. In this mode, the waveform area is printed out with it enlarged.
- Hardcopy of screen on main unit:
Prints out the whole screen.

The print setup and print start are and controlled through the WaveSurfer.

The contents of the print setup are set in the “Utilities Hardcopy” dialog box, (available in the WaveSurfer). For further information on operation, see the Getting Started Manual supplied with the WaveSurfer, or reference the on-line help.

The following describes the operation steps.

1. Touch [File] in the menu bar of the WaveSurfer screen, and then touch [Print Setup...] in the drop-down menu. The “Utilities Hardcopy” dialog box will be opened.



2. Select the printer icon at the left portion of the “Hardcopy” dialog box setup window.

3. Touch a blank spot in the “Select Printer” field. Select “LeCroy External USB Printer” from the pop-up menu of the touch pad.

When selecting “Strip Chart,” the option to select a waveform enlargement ratio becomes available. Click it to open the dialog box and select a desired enlargement ratio.

4. Start printing with either operating procedure shown below.

- Touch the Print icon at the right portion of the setup window.



- Press the Print button



on the front panel.

(i) Turning OFF the Printer

To turn OFF the printer, press the POWER button shown in Figure 17 for three or four seconds.

■ Indicators

The following describes the status indicators of the printer.

Normally, the POWER lamp is lit and the printer is ready for printing.

If an error occurs, the contents of this error are shown by the states (lighting or flashing) of the POWER and ERROR lamps.

Table 1 Printer Status Indications

POWER switch	Status	Lamp indication
ON	Normal status (Ready for printing)	POWER lamp Lit
		ERROR lamp Off
	Abnormal voltage	POWER lamp Flashing
		ERROR lamp Lit or Off
	Temperature error (See NOTE below)	POWER lamp Lit
		ERROR lamp Flashing
	Thermal paper run-out	POWER lamp Lit
		ERROR lamp Lit
OFF	Power OFF	POWER lamp Off
		ERROR lamp Off

NOTE This error is indicated when the temperature of the printer has risen and exceeded the limit after the printer was used for a long time. If this occurred, printing stops until the head cools off. After it has cooled, printing will restart.

■ Specifications

(a) Product Specifications

Table 2 shows the specifications of the printer while Table 3 shows the specifications of the accessories.

Table 2 Product Specification : Printer

Item	Specifications
Printing method	Thermal line dot method
Total dot counts	832 dot / dot line
Dot density	8 dot / mm
Printing width	104 mm
USB standard	In conformity with USB Specification Revision1.1
USB connection connector	USB 4P TypeB
DC connector	EIAJRC-5322 (Jack)
Power input	DC 24V±1V
Power consumption	Max. 30VA
Operating temperature	0°C to +40°C
Storage temperature	-20°C to +60°C
Humidity (During operation)	30%RH to 80%RH (non-condensing)
Humidity (During storage)	20%RH to 85%RH (non-condensing)
Outside dimensions	W: 154 ± 2 mm D: 129 ± 2 mm H: 66.3 ± 2 mm
Weight	Approximately 500g (Thermal paper roll is not included.)

* Power is supplied from the DC-OUT output of the main unit.

† Appearance and specifications are subject to change without prior notice.

Table 3 Product Specifications : Accessories

Item	Specifications
Thermal paper	Paper width: 112 mm Length: Approximately 6 m
DC cable	Length: 800 ± 10 mm Both ends of connector: EIAJRC-5322 (plug)
USB cable	Length: 500 ± 20 mm Connector: USB TypeA (one end), TypeB (other end)

1. Appearance and specifications are subject to change without prior notice.
2. To replenish the thermal paper for the printer, please order any of the following accessories.
 - TP-112-2 (paper width:112mm, length:25m, 20 rolls)
 - TP-112-5 (paper width:112mm, length: 25m, 50 rolls)

Either 20 rolls or 50 rolls are sold as one set.

(b) Certifications

EC Declaration of Conformity	<p>This printer conforms to the requirements stated in the following EMC directives and is a class A product in conformity with EN55022.</p> <p>EMC requirements for electrical equipment for measurement, control, and laboratory use.</p> <p>EN 55022:1998 Radiated Emissions (Class A)</p> <p>EN 61000-4-2:1995 Electrostatic discharge ($\pm 4\text{kV}$ contact discharge; $\pm 8\text{kV}$ air discharge)</p> <p>EN61000-4-3:1996 Radio-frequency electromagnetic field 3V/m (unmodulated, r.m.s.) 80% AM (1kHz)</p>
------------------------------	--

LeCroy Corporation

700 Chestnut Ridge Road

Chestnut Ridge, NY 10977-6499

Tel: (845) 578 6020, Fax: (845) 578 5985

Internet: www.lecroy.com

© 2004 by LeCroy Corporation. All rights reserved.

LeCroy, ActiveDSO, ProBus, JitterTrack, WavePro, WaveMaster, and Waverunner are registered trademarks of LeCroy Corporation. Information in this publication supersedes all earlier versions. Specifications subject to change without notice.

WaveSurfer Accessory

EXTERNAL USB PRINTER

LeCroy