

ROKSAN

Kandy

INTEGRATED CD PLAYER
MkIII

USER MANUAL

ROKSAN AUDIO LIMITED

6 NORTHFIELD INDUSTRIAL ESTATE
BERESFORD AVENUE ALPERTON
MIDDLESEX HA0 1NW ENGLAND

TEL. +44 (0)208 900 6801
+44 (0)208 900 6802
FAX. +44 (0)208 900 0734

LASER SAFETY

This unit employs a laser. Only qualified persons should remove the cover or attempt to service this unit due to the risk of eye injury.

Laser Diode Properties

Materials: Ga-Al-As
 Wavelength: 755-815 nm (25°C)
 Laser Output: Continuous Wave max. 0.7mW

CAUTION INVISIBLE LASER RADIATION WHEN OPEN AND INTERLOCKS DEFEATED. AVOID EXPOSURE TO BEAM.
 VORSICHT! UNSICHTBARE LASERTRABLUNG TRITTS AUS. WENN DECKEL GEÖFFNET UND WENN SICHERHEITSVERRIEGELUNG ÜBERBRÜCKT IST. NICHT DEM STRAHL AUSSETZEN!
 VARNING OSYNUG LASERSTRÄLNING NÄR DENNA DEL ÄR ÖPPNAD OCH SPÄRR ÄR URKOPPLAD. STRÄLEN ÄR FARLIG.
 ADVARSEL USYNLIG LASERSTRÄLING VED ÅBNING, NÄR SIKKERHEDSAFBRYDERE ER UDE AF FUNKTION. UNDGA UDSÆTELSE FOR STRÄLING.
 VARO! AVATTAESSA JA SUOJALUKITUS OHITETTAESSA OLET ALLTINA NÄKYMÄTTÖMÄLLE LASERSÄTEIL YLLE. ÄLÄ KATSO SÄTEESEEN.

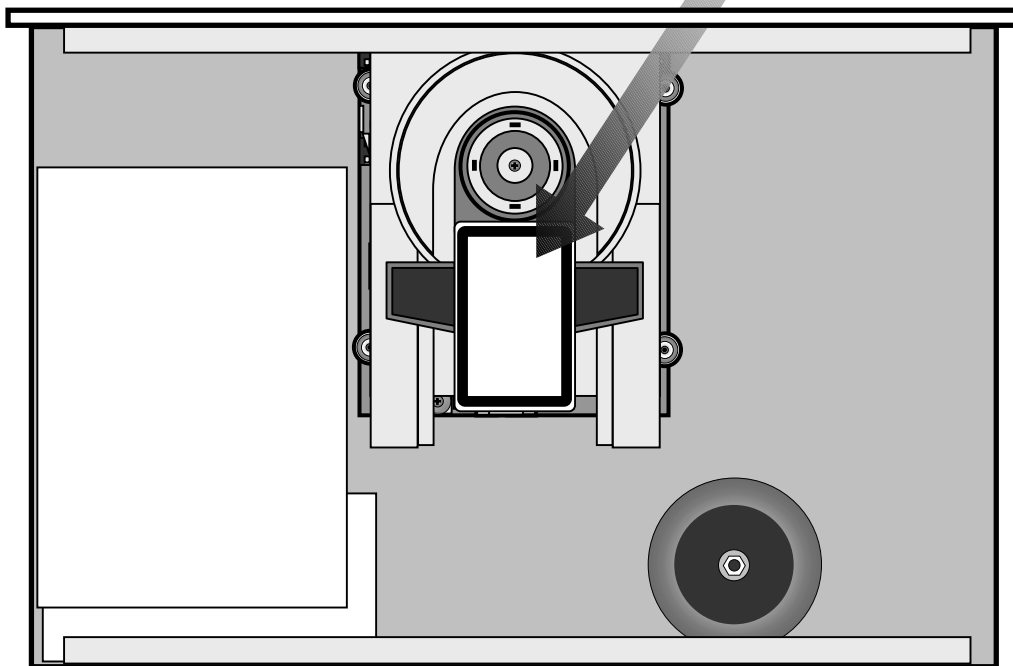

**CLASS 1 LASER PRODUCT
 LUOKAN 1 LASERLAITE
 KLASS 1 LASERAPPARAT**

Congratulations on your purchase of the ROKSAN Kandy Integrated CD Player. This CD Player is designed and manufactured to the highest specification and rigorously tested to reward you many years of listening pleasure.

Your Kandy CD Player is at the heart of your hi-fi system. Its correct installation, set-up and operation will have a profound influence on the sonic performance of the entire hi-fi installation.

Please read the contents of this manual thoroughly. It will help you to understand your hi-fi equipment better and enhance your listening pleasure.

This manual is divided into the following sections:

- Safety Instructions (Accompanying card)
- Safety Certification
- Introduction
- Cautions
- Installation
- Setup
- Operation
- Remote Control
- Troubleshooting
- Guarantee
- Specifications
- Notes

UNPACKING

Included in the packing of your Kandy CD Player you will find:

- One mains lead fitted with the correct mains power plug for your country
- One Kandy **MkIII Integrated amplifier / Integrated CD Player** Remote Handset and AA batteries (x2)
- One information pack and warranty card

After removing these items please retain **all** packing materials. Correct packing is necessary for safe transportation of your Kandy CD Player.

MAINTENANCE

After disconnecting the CD Player from the mains supply, the cabinet and front panel may be cleaned with a lightly dampened soft cloth or chamois leather. **Avoid using abrasives or solvents.**

EU DIRECTIVES

This product is designed to comply with the legal provisions of EU Directives 89/3336/EC and 72/23/EC. The standards which have been applied are those which were in force at the time of the introduction of this product.

This product bears the CE mark.



This product is compliant to EN 60065.

This product must be earthed. Please ensure that other equipment connected to it is earthed according to the manufacturer's instructions.

AC MAINS SUPPLY

Your Kandy CD Player is set to operate from a fixed supply voltage which is marked on a label next to the mains input plug. Before connecting the mains lead please check that your mains supply corresponds to this label as below:

230V Products	Voltage Range: 220V – 240V
115V Products	Voltage Range: 100V – 120V

The mains lead supplied with this product has an IEC mains socket which plugs into the IEC connector on the unit's rear panel. The other end is normally attached to the appropriate mains plug for your country. In the UK this is the standard UK13A plug.

This plug should ordinarily not be removed from the lead. If you *do* remove it, please dispose of it safely so that it cannot be plugged into a mains socket whilst in a potentially dangerous condition. We suggest that you obtain from your dealer a complete replacement lead.

Should you move to another area where either the mains voltage or the mains plugs are different from those as supplied with your CD Player, please contact the appointed ROKSAN distributor for assistance.

Please observe correct mains polarity at all times.

The CD Player mains fuses are located on the rear panel next to the IEC mains connector. They must only be replaced by the fuse of the type and rating as described on the fuse rating label on the rear panel of the unit.

This product requires connection to earth (ground). The earth wire (in the UK this is colour coded green/yellow) of the mains cable supplied with your CD Player must be connected to a suitable earthing point established for this purpose by your electricity supply company. If you are in any doubt, consult a qualified electrician.

If the equipment is likely to be unused for some time, unplug it from the mains supply.

GENERAL CAUTIONS

FCC WARNING

This equipment may generate or use Radio Frequency energy. The user may lose the right to operate this equipment if unauthorised modifications are made.

INTERFERENCE

Properly installed, this unit should not cause harmful interference to radio communications, There is, however, no guarantee that such interference will not occur in a specific installation. If interference arises (which you can determine by switching the unit off and on) you could try to remedy matters by the following:

- Re-orient or re-locate the receiving antenna
- Increase the distance between the CD Player and receiver
- Connect the unit to a different mains circuit from that of the receiver
- Consult your ROKSAN appointed dealer or an experienced Radio/TV technician for help and advice

LOCATION

Your Kandy CD Player should be located in a well ventilated area and kept away from sources of heat, dust and humidity and from direct sunlight.

The CD Player may be positioned either as a free standing unit or alongside another audio/video product.

Never place the CD Player on carpet or any surface likely to hinder normal ventilation.

Never allow liquids or other objects to fall into the unit.

This unit contains no user serviceable parts. **Do Not remove any panels or attempt to service it yourself.**

Unauthorised servicing will void the warranty.

ROKSAN Kandy CD Player- Front Panel View

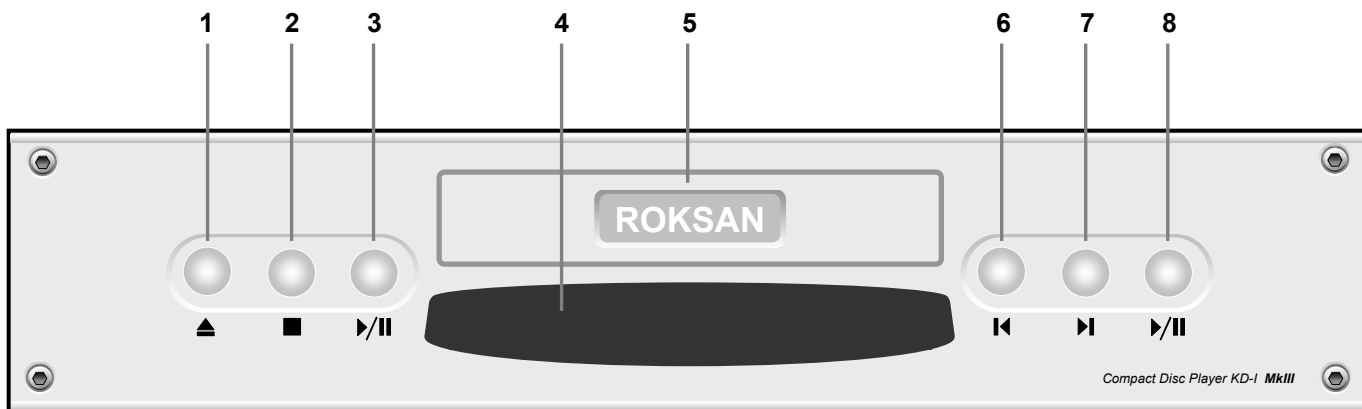

1. Open/Close Button
2. Stop Button
3. Play/Pause Button
4. FL Display
5. Drawer Mechanism Door
6. Track Back Button
7. Track Forward Button
8. Play/Pause Button

ROKSAN Kandy CD Player - Rear Panel View



1. Analogue Output (Left & Right)
2. Coaxial Digital Output
3. AC Mains Power Switch
4. Voltage & Fuse Rating Label
5. IEC Mains Inlet Socket
6. AC Mains Fuseholder

CONNECTING MAINS POWER

Please refer to the rear panel view on page 5. The moulded IEC connector of the supplied mains lead should be plugged into the socket (5) on the rear of the unit first and then plugged into the mains supply. The Mains power switch (3) is on the rear panel of the CD Player. This switch is normally left on. If the unit is likely to be unattended for a long period, switch it off and unplug the mains lead from the wall.

SIGNAL CONNECTIONS

ANALOGUE OUTPUT:

The Analogue Output (1) uses Gold plated RCA Phono sockets and should be connected to the CD or LINE input of your Preamplifier or Amplifier.

The connection is: Right Channel – Red; Left Channel – White or Black.

DIGITAL OUTPUT:

The Digital Output (2) uses a Gold plated RCA Phono socket and should be connected to an amplifier with a digital input, or to an outboard Digital to Analogue converter (DAC). Do **not** connect this socket to an optical input.

IMPORTANT NOTE: For optimum performance it is recommended to use high quality inter-connect cables such as ROKSAN HDC-02A High Definition Analogue Cable and HDC-01D High Definition Digital Cable.

Please refer to the rear panel view on page 5.

SWITCHING ON

The Mains power switch (3) is located on the rear panel of the CD Player. This switch should be left ON for normal operation. If unattended for a long period, the Mains power should be switched OFF and the lead disconnected from the power supply.

When switched ON from the rear panel, your Caspian CD Player FL Display will illuminate.

USING THE CONTROLS

Please refer to the front panel view on page 5.

LOADING A DISC

Press the Open/Close Button (1) once to open the disc loading tray. Carefully load a disc into the tray recess with the label side up. Press the button again to close the tray.

Note: Never load a disc until the drawer has opened fully, or try to close the drawer until you are sure that the disc is properly seated in the holder recess.

Warped discs should *never* be played.

The drawer should only be opened using the front panel control. Under no circumstances should you attempt to open manually.

If no disc is inserted or if the disc is damaged or inserted upside down, the CD Player will remain inoperative and the display will indicate:

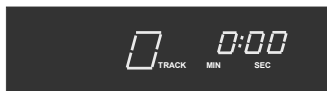

PLAYING A DISC

When a disc has been loaded, your Kandy CD Player will briefly spin the disc while it studies the data encoded on it. The disc will then stop and the display will indicate the number of tracks on the disc and the total play time. After about 10 seconds the display will revert to:



There is a Play/Pause Button (**3, 8**) on each side of the central drawer mechanism. Their operation is identical and interchangeable.

To commence playing a disc, press Play/Pause Button (**3 or 8**) once. The disc will play from the beginning. To pause the disc whilst it is playing, press the Play/Pause button (**3 or 8**) a second time. Pressing the button again will resume playback from the point at which Pause mode was entered. In Pause mode, the disc continues spinning and the laser will still be operational but locked. Please keep the CD Player in Pause mode no longer than strictly necessary.

SELECTING A TRACK

Press the Track Forward Button (**7**) to go to the next track on the disc. Pressing the Track Back Button (**6**) will take you to the previous track.

***** When the disc is playing, press the Track Back Button once to take you to the beginning of the current track and a second time to take you to the start of the previous track.

Press the Track Forward Button (**7**) to take you forward to the start of the next track.

Once the procedure is complete the disc will commence playing from the selected track.

When a disc is first loaded you can use these buttons to choose your track. Having done so, press the Play/Pause Button and your disc will commence playing from the selected track.

You may select a track when Pause is engaged. In this case, the disc will revert to Pause after the procedure is complete and you will have to press Play/Pause Button to continue playing the disc.

When a disc reaches the end, it will stop and the display will revert to:



Your CD Player is supplied with a Kandy **MkIII** Integrated amplifier / Integrated CD Player Remote Control Handset.

The Remote Control Handset is powered by two 1.5V AA batteries (supplied). When inserting the batteries observe the correct polarity.

The handset duplicates all front panel controls and contains several additional features.

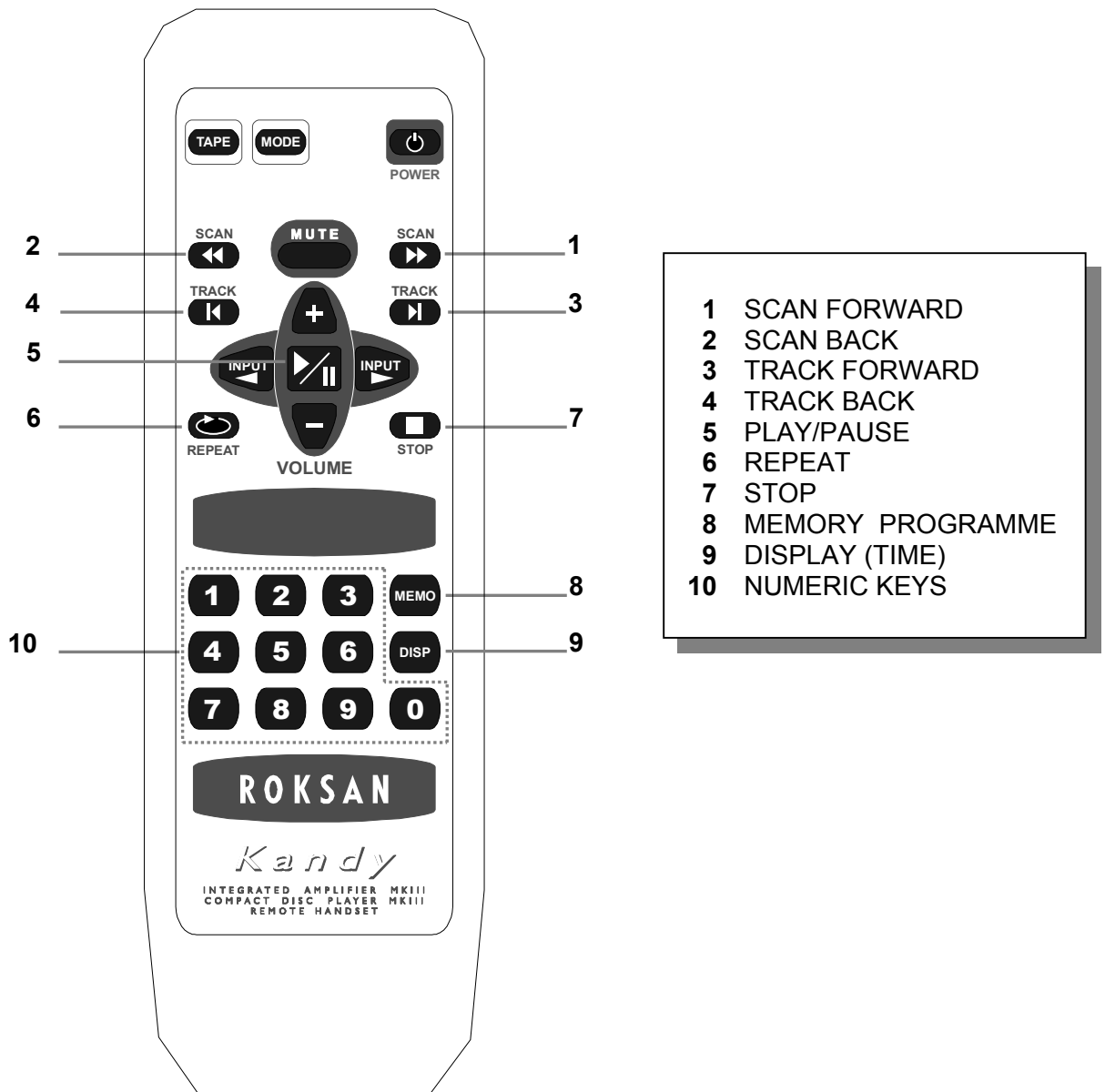



REPEAT

To repeat the disc press the Repeat Button **(6)**. To cancel this function press Repeat Button again.

DISPLAY

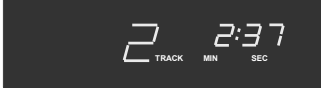
Pressing the Display Button **(9)** repeatedly will cycle the display through the following modes:

	Normal	
Display <i>Indicates track No. and how long it has been playing.</i>		
	First Press	
Display <i>Indicates total time remaining on the disc.</i>		
	Second Press	
Display <i>Indicates time elapsed from start of the disc.</i>		

MEMORY

Pressing the Memory Button **(8)** lets you select specific tracks and play them in any order. Programming must be performed in STOP mode.

To programme a sequence:

- 1 Select a track from the handset, using the Track Back, Track Forward Buttons **(4, 3)**, or via the Numeric Keys **(10)**.
- 2 Press Memory Button **(8)**.

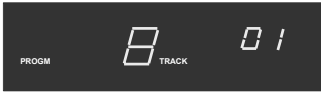
Display <i>The word PROGM lights and the display shows 01 for the first programmed track.</i>	
---	---

- 3 Repeat this procedure for each track you wish to programme. You may programme a maximum of 20 tracks. Select a track from the handset, using the Track Back, Track Forward Buttons **(4, 3)**, or via the Numeric Keys **(10)**.

Display <i>Select the next desired track; the display flashes 02.</i>	
--	---

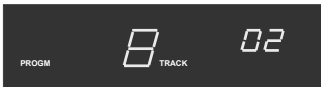
Display <i>Press Memory Button to register 02. And so on...</i>	
--	---

- 4 When you have assembled your programme, press the Play Button to start Programme Play.

TO CANCEL PROGRAMMED TRACKS

Press the Stop Button on the front panel **(2)** or Stop Button from the remote handset **(7)** to clear all programmed tracks.

If you suspect that your ROKSAN Kandy CD Player is not operating properly, you should check all the connections carefully. Pay particular attention to input and output connections. Phono plugs should be fully inserted- a frequent cause of problems is that Phono plug surrounds do not make proper contact. Below are some commonly encountered problems with suggestions for possible cure. The list is not exhaustive: If you have any unresolved problems, please consult your appointed ROKSAN dealer or distributor.

SYMPTOM	LIKELY CAUSE	SUGGESTED REMEDY
The disc tray will not close when a disc is inserted	Disc not placed properly in tray Disc is warped	Replace disc properly Discard disc
Disc inserts, display does not show the number of tracks and playing time	Disc inserted upside down Disc is dirty or scratched Condensation on the laser lens Dirt on the laser lens	Re-insert disc Clean disc, discard scratched disc Let CD player warm up and dry out lens Refer to appointed dealer or service centre
Skipping & mistracking	Excessive vibration Disc is dirty or scratched	Ensure player is stable and vibration-free Clean disc, discard scratched disc
Programme play inoperative	Programming accidentally erased	Re-programme memory
Excessive hum	Connection loose, cable faulty	Re-connect plugs, change interconnect
One channel inoperative	Interconnect or amplifier faulty	Change lead, try another line input on amp
Remote handset operation erratic or not working	Batteries weak or wrongly inserted Handset signal path is obstructed Handset transmission angle too wide Room lighting/sunlight excessive	Replace batteries, observe polarity Remove obstruction, move handset Operate handset in front of CD Player Darken room

There are no user-serviceable parts inside your Kandy CD Player. If a fault should develop, refer any servicing to your appointed ROKSAN dealer, distributor or ROKSAN approved service agent.

Your ROKSAN Kandy CD Player is guaranteed against any defect in materials and workmanship for a period of **two years** from the date of purchase.

This guarantee only becomes effective if the warranty card is validated by the ROKSAN retailer from whom the equipment was purchased and returned to ROKSAN within **28 days** of purchase.

This guarantee excludes:

1. Damage caused due to accident, misuse, neglect and incorrect installation, adjustment or repair.
2. Liability for damage or loss during transit from the retailer or purchaser to ROKSAN or its authorised distributor for the purposes of repair or inspection.

Carriage costs to ROKSAN shall be borne by the consignor.

All claims under this guarantee must be made through an authorised ROKSAN retailer.

If equipment returned for repair to ROKSAN is found on inspection to comply with the product specification ROKSAN reserves the right to make a charge for examination and return carriage.

Unauthorised servicing will void this guarantee.

SPECIFICATIONS

K a n d y Integrated CD Player

Operating System	CD digital audio system
Frequency Response	20Hz – 20kHz ± 0.3dB
Harmonic Distortion	< 0.004% @ 1kHz
S/N Ratio (IHF-A Wtd.)	100 dB
Wow & Flutter	Quartz precision
Channel Separation	100 dB @ 1kHz
Output Voltage	2Vrms
Digital Output	Gold Plated RCA 0.5 Vp-p
Error Correction	CIRC
Sampling Frequency	44.1 kHz
D/A Conversion	Dedicated D/A PCB (TD1305T BCC-DAC2) (Bitstream continuous calibration DAC)
Resolution	18 bits
Oscillation	3 rd Overtone Oscillation
Crystal	Super precision, custom made
Power Supply	high performance low noise toroidal transformers 7 fully regulated power rails
Power Source	100V – 120V 50Hz / 60Hz 220V – 240V 50Hz / 60Hz
Power Consumption	< 15 W
Dimension	432 x 380 x 90 (W x D x H) mm 432 x 380 x 102 (including feet)
Weight	9Kg

NOTES

K a n d y Integrated CD Player

Kandy CD Player MkIII

Serial Number:

Purchase Date

Year Month Day

ROKSAN Retailer

Name:

Location:

Please keep a record for future reference