

RD8000™

RADIODETECTION'S UNIVERSAL PRECISION CABLE, PIPE AND RF MARKER LOCATOR

90/RD8KM-OPMAN-ENG/01 ISSUE 1 2/2014

READ AND UNDERSTAND THIS MANUAL PRIOR TO OPERATING THE SYSTEM



This page is intentionally blank

Preface

Before you begin

Thank you for your interest in Radiodetection's RD8000™ cable, pipe and RF marker locator.

The RD8000 marker locator delivers the very latest in cable, pipe and RF marker location technology in a powerful yet ergonomic and light-weight design.

Please read this user manual in its entirety before attempting to use the RD8000 system.

Radiodetection products, including this manual, are under continuous development. The information contained within is accurate at time of publication; however the RD8000, this manual and all its contents are subject to change.

Radiodetection Limited reserves the right to modify the product without notice and some product changes may have taken place after this user manual was published.

Contact your local Radiodetection dealer or visit www.radiodetection.com for the latest information about the RD8000 product family, including this manual.

Important notices

General

The performance of any cable and pipe locator may be affected when used in close proximity to ferrous materials such as manhole covers, steel-toe boots, mobile phones and nearby vehicles. Keep a distance of one or two meters from these objects when taking critical measurements such as depth and current readings.

This instrument, or family of instruments, will not be permanently damaged by reasonable electrostatic discharge and has been tested in accordance with IEC 801-2. However, in extreme cases temporary malfunction may occur. If this happens, switch off, wait and switch on again. If the instrument still malfunctions, disconnect the batteries for a few seconds.

Safety

This equipment shall be used only by fully qualified and trained personnel, and only after fully reading this Operation Manual.

 **WARNING!** Direct connection to live conductors is **POTENTIALLY LETHAL**. Direct connections to live conductors should be attempted by fully qualified personnel only using the relevant products that allow connections to energized lines.

 **WARNING!** The transmitter is capable of outputting

potentially lethal voltages. Take care when applying signals to any pipe or cable and be sure to notify other technicians who may be working on the line.

 **WARNING!** Reduce audio level before using headphones to avoid damaging your hearing.

 **WARNING!** This equipment is **NOT** approved for use in areas where hazardous gases may be present.

 **WARNING!** When using the transmitter, switch off the unit and disconnect cables before removing the battery pack.

 **WARNING!** The RD8000 locator will detect most buried conductors but there are some objects that do not radiate any detectable signal. The RD8000, or any other electromagnetic locator, cannot detect these objects so proceed with caution. There are also some live cables which the RD8000 will not be able to detect in Power mode. The RD8000 does not indicate whether a signal is from a single cable or from several in close proximity.

 **CAUTION:** The battery dust cover, the accessory cover and the headphones cover protects the locator's sockets from debris and water ingress. If they get damaged or lost, contact Radiodetection or your local service representative for a replacement one.

Batteries

 **WARNING!** Batteries can get hot after prolonged use at full output power. Take care while replacing or handling batteries.

CAUTION: Do not tamper with, or attempt to disassemble the battery packs.

CAUTION: If battery failure is suspected return the entire unit to an authorized repair center for investigation and repair. Local, national or IATA transport regulations may restrict the shipment of faulty batteries. Check with your courier for restrictions and best practice guidelines. Talk to a Radiodetection sales representative for authorized repair centers.

 **WARNING:** Exposing the battery to a high temperature above 60°C (140°F) may activate safety systems and cause a permanent battery failure.

Battery disposal

Batteries should be disposed of in accordance with your company's work practice, and / or the relevant laws or guidelines in your country or municipality.

Special Bluetooth® notice

RD8000 locators and transmitters contain a Class 1 Bluetooth device that can emit radio frequency energy during the operation of certain product features. While the Bluetooth device is busy, pairing or sending iLOC™ commands from the locator to the transmitter, or sending SurveyCERT™ data, always ensure a minimum separation of 200mm (8 inches) between the Bluetooth antenna and your body. The location of the antenna is shown in Section 2, figure 2.1.

Wireless technology compliance

Use of iLOC wireless technology where applicable may be subject to national telecommunication regulations. Check with your local government authorities for further information.

Compliance

EU Compliance

This equipment complies with the following EU Directives:

R&TTE Directive 1999/5/EC

Low Voltage Directive: 2006/95/EC

EMC Directive: 2004/108/EC

FCC Compliance Statement

This equipment complies with Part 15 of the FCC Rules. Operation is subject to the following two conditions:

The equipment may not cause harmful interference.

The equipment must accept any interference received, including interference that may cause undesired operation.

NOTE: This equipment has been tested and found to comply with the limits for a Class A digital device pursuant to Part 15 of the FCC Rules. These limits are designed to provide reasonable protection against harmful interference when the equipment is operated in a commercial environment. This equipment generates, uses, and can radiate radio frequency energy and, if not installed and used in accordance with the manufacturer's instruction manual, may cause harmful interference with radio communications. Operation of this equipment in a residential area is likely to cause harmful interference, in which case you will be required to correct the interference at your own expense.

Modifications: Any modifications made to this equipment not approved by Radiodetection may void

the authority granted to the user by the FCC to operate this equipment.

Industry Canada Compliance Statements

ICES-003 Class A Notice:

This Class A digital apparatus complies with Canadian ICES-003.

Avis NMB-003, Classe A: Cet appareil numérique de la classe A est conforme à la norme NMB-003 du Canada

Training

Radiodetection provides training services for most Radiodetection products. Our qualified instructors will train equipment operators or other personnel at your preferred location or at Radiodetection headquarters.

For more information go to www.radiodetection.com or contact your local Radiodetection representative.

Copyright statement

Bluetooth word, mark and logos are registered trademarks of Bluetooth Sig, Inc. and any use of such trademarks by Radiodetection is under license. Windows, Windows Vista and Windows XP are either registered trademarks or trademarks of Microsoft Corporation in the United States and / or other countries.



Declaration of Conformity

We: **Radiodetection Limited**
Western Drive
Bristol
BS14 0AF

Declare that the products listed below satisfy the essential requirements of the following Council Directive(s):

- 1999/5/EC R&TTE Directive

RF Marker Locator Series – including the following models:

Description	Sales Part No	Inventory Part No
RD7K+ DLM	10/7KDL+M	10/7MDL
RD7K+ PLM LOG	10/7KPL+M-LOG	10/7MPLL
RD7K+ SLM	10/7KSL+M	10/7MSL
RD7K+ TLM LOG	10/7KTL+M-LOG	10/7MTLL
RD8K PDLM	10/8KPDLM	10/8MPDL
RD8K PDLM LOG GPS	10/8KPDLM-LOG-GPS	10/8MPDLG
RD8K PDLM LOG	10/8KPDLM-LOG	10/8MPDLL
RD8K PXML	10/8KPXML	10/8MPXL
RD8K PXML LOG GPS	10/8KPXML-LOG-GPS	10/8MPXLG
RD8K PXML LOG	10/8KPXML-LOG	10/8MPXLL
RD8K PTLM -	10/8KPTLM1	10/8MTLN
RD8K PTLM LOG -	10/8KPTLM2-LOG	10/8MTLNL
RD8K PTLM LOG GPS -	10/8KPTLM3-LOG-GPS	10/8MTLNG
RD8K PTLM -	10/8KPTLM4	10/8MTLA
RD8K PTLM LOG -	10/8KPTLM5-LOG	10/8MTLAL
RD8K PTLM LOG GPS -	10/8KPTLM6-LOG-GPS	10/8MTLAG
RD8K PTLM	10/8KPTLM-ROW	10/8MTLR
RD8K PTLM LOG GPS	10/8KPTLM-LOG-GPS-ROW	10/8MTLRG
RD8K PTLM LOG	10/8KPTLM-LOG-ROW	10/8MTLRL

The following harmonised standards have been used in the evaluation

EN61326-1:2006	Electrical equipment for measurement, control and laboratory use - EMC requirements
EN 300 330-2 (V1.5.1)	EMC and Radio Spectrum Matters (ERM) SRD equipment 9 kHz to 30 MHz
EN 300 440-2 (V1.3.1)	EMC and Radio spectrum Matters (ERM) SRD equipment 1 GHz to 40 GHz
EN 301 489-3 (V1.6.1)	EMC and Radio spectrum Matters (ERM) EMC for SRD 9 kHz and 246 GHz
EN 301 489-17 (V2.2.1)	EMC and Radio spectrum Matters (ERM) EMC Broadband Data Systems
EN61010-1:2010	Safety requirements for electrical equipment for measurement and control

The Technical Construction File has been drawn up to demonstrate compliance and is kept at the above address

Signed

Darren Hill
Engineering Director

Radiodetection Ltd
Western Drive
Bristol BS14 0AF, UK
Tel: +44 (0) 117 976 7776
Fax: +44 (0) 117 976 7775
<http://www.radiodetection.com>

Date: February 2014



Certificate No. DC2011



Declaration of Conformity

We: **Radiodetection Limited**
Western Drive
Bristol
BS14 0AF

Declare that the products listed below satisfy the essential requirements of the following Council Directives:

- 1999/5/EC R&TTE Directive

TX Location signal generator - including the following models:

Description	Sales Part No	Inventory Part No
TX-1 Transmitter	10/RDTX1	10/TX-1
TX-3 Transmitter	10/RDTX3	10/TX-3
TX-3(Bluetooth)	10/RDTX3B	10/TX-3B
TX-5	10/RDTX5	10/TX-5
TX-5(Bluetooth)	10/RDTX5B	10/TX-5B
TX-10 Transmitter	10/RDTX10	10/TX-10
TX-10(Bluetooth)	10/RDTX10B	10/TX-10B

The following standards have been used in the evaluation

EN 300 328-2 V1.6.1
EN 300 330-2 (June 2001)

EN 301 489-1 V1.4.1
EN 300 489-3 V1.2.1
EN 301 489-17 V1.1.1
EN 61000-6-2
EN 61000-6-4

EN 61010-1:2001

The Technical Construction File has been drawn up to demonstrate compliance and is kept at the above address

Signed

Darren Hill
Engineering Director

Date: February 2014

Radiodetection Ltd
Western Drive
Bristol BS14 0AF, UK
Tel: +44 (0) 117 976 7776
Fax: +44 (0) 117 976 7775
<http://www.radiodetection.com>

Radiodetection®

Certificate No. DC2008 rev 1

Contents

Section 1 - Introduction.....	1	3.11 Bluetooth wireless	13
1.1 About this manual	1	3.12 iLOC and SideStep.....	13
1.1.1 Additional documentation	1	3.13 SideStep ^{auto} ™	13
1.1.1.1 Additional documentation	1	3.13.1 Using SideStep ^{auto}	13
1.2 About the RD8000.....	1	3.14 Transmitter power output.....	13
1.3 Extended Warranty	1	3.14.1 Adjusting power output	13
1.4 Manual outline.....	1	3.14.2 Boost (Tx-10(B) only).....	13
1.5 Safety	1	3.15 Transmitter Eco mode	14
Section 2 - System overview	4	3.16 Measure mode.....	14
2.1 RD8000 marker locator	4	3.16.1 Impedance and voltage measurements.....	14
2.1.1 Locator features	4	3.16.2 Impedance measurements using active frequency	14
2.1.2 Locator keypad.....	4	3.17 CALSafe	15
2.1.3 Locator screen icons	4	3.18 Automatic Logging.....	15
2.2 Tx-1, Tx-5 and Tx-10 transmitters.....	6	3.19 GPS	15
2.2.1 Transmitter features	6	3.19.1 GPS menu	15
2.2.2 Transmitter keypad.....	6	3.19.2 Internal GPS	15
2.2.3 Transmitter screen icons	6	Section 4 - Locating cables and pipes	17
2.3 Using the menu	6	4.1 Frequencies	17
2.3.1 Navigating the locator menu.....	6	4.1.1 Passive frequencies.....	17
2.3.2 Locator menu options.....	6	4.1.2 Active frequencies.....	17
2.3.3 Navigating the transmitter menu	7	4.1.3 Selecting Frequencies	18
2.3.4 Transmitter menu options.....	7	4.2 Antenna modes	18
Section 3 - Operation.....	8	4.2.1 Peak mode.....	18
3.1 First use	8	4.2.2 Single antenna mode	18
3.2 Powering up	8	4.2.3 Null mode.....	18
3.2.1 Power Options	8	4.2.4 Combined Peak / Null mode	19
3.3 Shutting down	10	4.2.5 Guidance mode.....	19
3.4 System setup	10	4.3 Compass.....	19
3.4.1 Language.....	10	4.4 Trace.....	19
3.4.2 Battery type	10	4.5 Pinpoint.....	19
3.4.3 Power frequency (locator only).....	11	4.6 Sweep and search.....	20
3.4.4 Measurement Units (locator only)	11	4.6.1 Passive Sweep	20
3.4.5 Enable / Disable frequencies.....	11	4.6.2 Inductive search.....	20
3.4.6 Marker locator.....	11	Section 5 - Locating RF Markers.....	22
3.4.7 Volume Control.....	12	5.1 Marker Mode	22
3.5 Dynamic overload protection™	12	5.1.1 Entering Marker mode	22
3.6 TruDepth™ measurement	12	5.1.2 Changing RF marker type.....	22
3.7 Passive avoidance	12	5.1.3 Combined mode.....	23
3.8 StrikeAlert™	12	5.2 Locating RF markers	23
3.9 Antenna modes.....	12	5.2.1 Single mode locating.....	23
3.10 Backlight.....	12		

5.2.2 Combined mode locating.....	23	8.6.2 How to use a stethoscope.....	34
Section 6 - Depth and current readings	24	8.6.3 Types of stethoscope	34
6.1 TruDepth™	24	8.7 Submersible antenna.....	35
6.1.1 TruDepth for RF Markers.....	24	8.7.1 When to use a submersible antenna	35
6.1.2 TruDepth for buried conductors or sondes ..	24	8.7.2 How to use a submersible antenna.....	35
6.2 Verifying depth measurements	25	Section 9 - Fault-Finding	36
6.2.1 Rough depth calibration check	25	9.1 About fault-finding.....	36
6.3 Current Readings	26	9.2 Preparation	36
6.3.1 Identification using current measurements..	26	9.2.1 Connecting the transmitter	36
6.3.2 About current measurements	26	9.2.2 Reference readings.....	36
6.3.3 Applying a transmitter signal	26	9.3 How to find a fault	37
6.3.4 Signal current measurements.....	26	Section 10 - Current direction (CD)	38
Section 7 - General Locating tips.....	28	10.1 Understanding CD	38
7.1 Eliminating services.....	28	10.1.1 Using Current Direction (CD) to aid line	
7.1.1 Induction	28	identification	38
7.1.2 Unwanted signal coupling.....	28	10.2 CD Reset	38
7.2 Signal grounding	29	10.2.1 About CD reset.....	38
7.2.1 Manhole covers	29	10.2.2 Using a CD clamp or stethoscope	39
7.2.2 Using lighting columns.....	29	10.2.3 Performing a CD reset	39
7.2.3 Finding a good ground point.....	29	Section 11 - Survey measurements	40
7.3 Double-ended connections.....	29	11.1 Saving measurements	40
7.3.1 Making a double-ended connection.....	29	11.2 Survey measurement transmission over	
Section 8 - Using Accessories	30	Bluetooth.....	40
8.1 About accessories	30	11.3 Erasing measurements.....	40
8.2 Headphones	30	11.4 SurveyCERT	40
8.3 Locator clamps	30	Section 12 - Bluetooth wireless connections.....	42
8.3.1 When to use clamps	30	12.1 Switching Bluetooth On	42
8.3.2 Connecting a clamp	30	12.2 Switching Bluetooth off	42
8.3.3 Available locator clamps.....	30	12.3 Pairing to a transmitter.....	42
8.4 Transmitter clamps.....	31	12.4 Pairing to a PDA	43
8.4.1 Connecting the clamp.....	31	12.4.1 Connection requirements.....	43
8.4.2 Available transmitter clamps.....	32	12.4.2 Pairing	43
8.5 Sondes	32	12.5 Bluetooth Protocol	43
8.5.1 What is a Sonde	32	12.6 Bluetooth Range	43
8.5.2 Choosing a suitable sonde	32	12.6.1 Long Range settings	43
8.5.3 Preparation	33	12.6.2 Standard Range settings.....	43
8.5.4 Propelling a sonde	33	12.7 Bluetooth Connection mode	44
8.5.5 Locating and tracing a sonde	33	12.8 Troubleshooting	44
8.5.6 Checking sonde depth.....	33	12.8.1 Resetting connections.....	44
8.5.7 FlexiTrace	34	12.8.2 Bluetooth error codes.....	45
8.6 Stethoscopes.....	34	Section 13 - iLOC	46
8.6.1 When to use a stethoscope	34	13.1 Using iLOC	46
		13.1.1 Changing frequencies	46

13.1.2 Adjusting power	46
13.1.3 Sleep / wake the transmitter	46
13.1.4 SideStep	47
Section 14 - Appendices	48
14.1 Care and maintenance	48
14.1.1 General	48
14.1.2 Batteries and power supply	48
14.1.3 Cleaning	48
14.1.4 Disassembly	48
14.1.5 Service and maintenance	48
14.2 Time and Date error messages	48
14.3 Warranty and extended warranty	48
14.3.1 Registering using e-mail	49
14.4 RD Manager™	49
14.5 Upgrading software	49
14.6 eCert	49
14.7 System Specifications	50
14.8 Supported frequencies	51
14.8.1 Sonde Frequencies	51
14.8.2 Passive Frequencies	51
14.8.3 CD Frequency Pairs	51
14.8.4 Active Frequencies	52
14.9 RF Markers	53
14.10 Supported accessories	53

Section 1 - Introduction

1.1 About this manual

This manual provides cable and pipe survey professionals with comprehensive operating instructions for the RD8000 locator and transmitter system. Before operating the RD8000 system it is very important that you read this manual, noting all safety warnings and procedures.

1.1.1 Additional documentation

The RD Manager and SurveyCERT manuals are available to download from www.radiodetection.com.

1.2 About the RD8000

The RD8000 system provides the user with fast, effective means of locating and mapping buried utilities.

The RD8000 product family offers a comprehensive range of locators and transmitters designed to meet specific customer needs.

The RD8000 marker locator is ergonomically designed to provide the operator with a balanced, light weight tool that encourages extended use in most environments.

The RD8000 range of transmitters and locators offers a wide range of accessories designed to enhance the performance and to add extra functionalities.

For more information about the Precision Locate Accessories Range visit www.radiodetection.com

1.3 Extended Warranty

RD8000 Marker locators and transmitters are covered by a 1 year warranty as standard.

Customers can extend the warranty period to a total of 3 years by registering their products (locators and transmitters) within 3 months from purchase.

Registration is performed using the RD Manager PC software. See section 14.3 for further details

NOTE: You can also register your products by e-mail. See section 14.2 for more details

From time to time Radiodetection may release new software to improve the performance or add new functionalities to his products. By registering the user will benefits from subscribing to e-mail alerts advising about any new software and special offers related to its product range.

Users will be able to opt out at any moment from receiving software and technical notifications or just from receiving marketing material.

1.4 Manual outline

Section 1 includes an overview of safety procedures and notices. Please review them before moving on to Section 2 and the rest of this manual

Section 2 provides an overview of the RD8000 system with annotated diagrams of the locator and transmitter

Section 3 introduces basic setup and operation using the RD8000 locator's menu system.

Section 4 introduces the survey storage capabilities of the locator. At a touch of a button your locator will store in its internal memory up to 1000 survey points for easy reporting and integration to GIS / Mapping systems

Section 5 provides instructions on how to use the RD8000 locator's Bluetooth technology to pair to external devices.

Section 6 introduces iLOC, Radiodetection's advanced remote control technology that allows you to control a Bluetooth transmitter (Tx-5B or Tx-10B) using the RD8000 Marker locator.

Section 7 introduces the theory and practice of cable and pipe location using the RD8000 marker locator and transmitter.

Section 8 provides instructions on locating RF markers

Section 9 introduces depth and current readings.

Section 10 provides general locating tips.

Section 11 introduces the range of accessories that are compatible with the RD8000 system.

Section 12 introduces cable sheath fault-finding using the RD8000 marker locator and an accessory A-frame.

Section 13 introduces current direction (CD) mode.

Section 14 includes several appendices with reference material and other technical information.

1.5 Safety

Please read this manual in its entirety before attempting to operate the RD8000 locator or transmitter. Note all safety notices in the preface and throughout this manual.

Follow your company and national safety procedures and or requirements when operating this equipment in any environment or workplace. If you are unsure what policies or procedures apply, contact your company or site's occupational health and safety officer or your local government for more information.

Do not use this equipment if you suspect that any component or accessory is damaged or faulty.

Use authorized accessories only. Incompatible accessories may damage the equipment or give inaccurate readings.

Do not use iLOC or Bluetooth in areas where wireless communication devices are considered hazardous. Check local authorities for more information.

Keep this equipment clean and arrange for regular services with an authorized Radiodetection service center. More information can be found in the Appendix or from your local Radiodetection representative.

Do not attempt to open or dismantle any part of this equipment unless directed specifically by this manual. Doing so may render the equipment faulty and may void the manufacturer's warranty.

A risk assessment of digging activities is recommended prior to commencing. We cannot be held liable for inaccurate surveys or consequential damages.



Figure 2.1: RD8000 Marker Locator

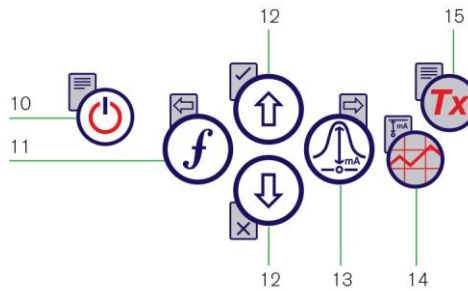

Figure 2.2: Locator keypad

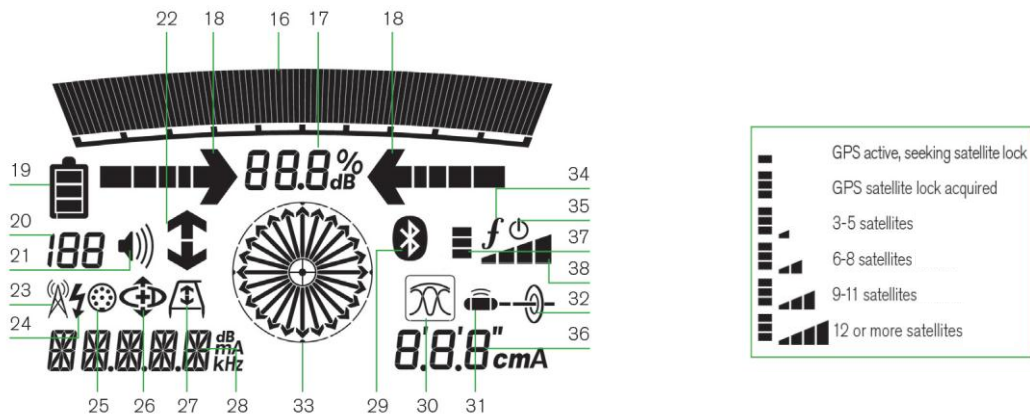

Figure 2.3: Locator LCD display







Section 2 - System overview

2.1 RD8000 marker locator

2.1.1 Locator features

- 1 Keypad
- 2 LCD with auto backlight
- 3 Speaker
- 4 Battery compartment
- 5 Battery charger socket
- 6 Accessory socket
- 7 Headphone socket
- 8 Bluetooth module antenna
- 9 Marker loop antenna

2.1.2 Locator keypad

- 10 Power key : Switches the unit on and off. Opens the locator menu
- 11 Frequency key : Selects frequency. Closes submenu
- 12 Up and down arrows  : Adjusts the signal gain. Scrolls through the menu options
- 13 Antenna key : With antenna folded up, toggles peak, combined peak / null, null, single antenna and guidance modes. With antenna folded down, toggles marker and combined (marker / line) modes. Opens a submenu
- 14 Graph key : Saves Survey measurements
- 15 Transmitter key : Sends iLOC commands to Bluetooth transmitters

2.1.3 Locator screen icons

- 16 Indicates the signal strength and peak marker
- 17 Signal strength: Numerical indication of signal strength
- 18 Peak / Proportional arrows: Indicates the location of the line relative to the locator
- 19 Battery icon: Indicates the battery level

- 20 Sensitivity and Log number: Displays the log number momentarily after a survey measurement is saved to memory
- 21 Volume icon: Displays the volume level
- 22 Current Direction arrows
- 23 Radio Mode: Indicates when Radio Mode is active
- 24 Power Mode: Indicates when Power Mode is active
- 25 Accessory indicator: Indicates when an accessory is connected
- 26 CD Mode icon: Indicates when Current Direction Mode is active
- 27 A-Frame icon: Indicates when the A-Frame is connected
- 28 Operating mode indicator
- 29 Bluetooth icon: Indicates status of Bluetooth connection. Flashing icon means pairing is in progress. Solid icon indicates an established connection is active
- 30 Antenna mode icon: Indicates antenna selection: Peak, Null, Single, combined Peak / Null and Guidance Mode
- 31 Sonde icon: Indicates that the signal source is from a sonde
- 32 Line icon: Indicates that the signal source is from a line
- 33 Compass / Marker mode indicator: Shows the direction of the located cable relative to the locator. Also used as a graphical indication for Marker mode active
- 34 Tx status (with Bluetooth Tx models): Displays transmitter connection status
- 35 Tx standby (with Bluetooth Tx models): Indicates that the transmitter is in Standby Mode
- 36 Current / depth indicator
- 37 GPS Status icon (GPS models only): One bar indicates that GPS is active. 3 bars indicates that the GPS has locked to the GPS satellite system
- 38 GPS Signal quality icon (GPS models only): Indicates the quality of the signal being received

Figure 2.4 Tx Transmitter



Figure 2.5 D-cells battery holder

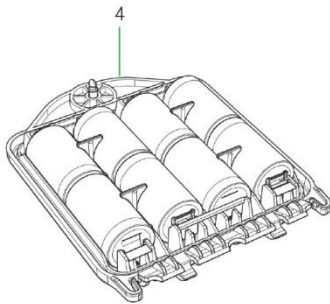

Figure 2.6 Rechargeable battery pack



Figure 2.6: Tx Transmitter keypad

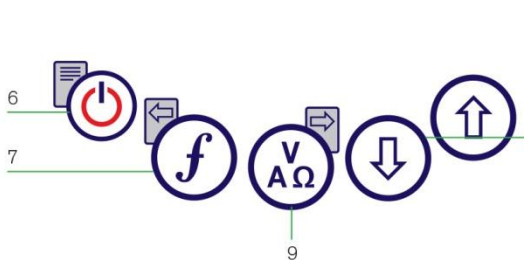
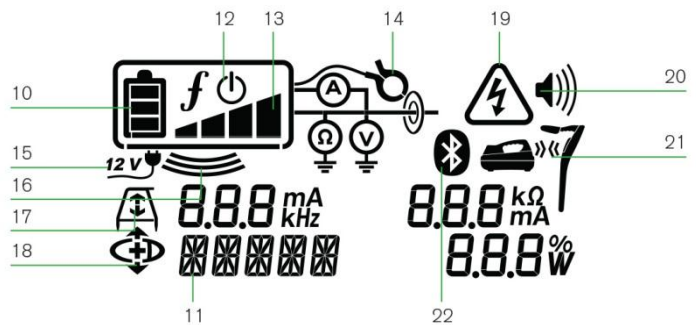

Figure 2.7 Tx Transmitter LCD







2.2 Tx-1, Tx-5 and Tx-10 transmitters

2.2.1 Transmitter features

- 1 Keypad
- 2 LCD
- 3 Removable accessory tray
- 4 D-cells battery holder
- 5 Rechargeable battery pack (Optional)





2.2.2 Transmitter keypad

- 6 Power key : Switches the unit on and off. Opens the transmitter menu
- 7 Frequency key : Selects frequency. Menu navigation key
- 8 Up and down arrows  : Adjusts the output signal. Scrolls through the menu options
- 9 Measure key : Opens a sub menu. Used to take voltage and impedance measurements.









2.2.3 Transmitter screen icons

- 10 Battery icon: Indicates the battery level
- 11 Alphanumeric description of selected operation mode
- 12 Standby icon: Appears when the transmitter is in Standby Mode
- 13 Output level: Displays transmitter output power
- 14 Accessory or Measurement indicators: Indicates if an accessory is connected or if measure mode is active
- 15 DC icon: Appears when the transmitter is powered from a DC source
- 16 Induction indicator: Appears when the transmitter is in Induction Mode
- 17 A-Frame (Tx-5(B) or Tx-10(B) only): Indicates when the transmitter is in Fault-Find Mode
- 18 CD Mode indicator (Tx-10(B) only): Indicates that the transmitter is in Current Direction Mode
- 19 Voltage warning indicator: Indicates that the transmitter is outputting potentially hazardous voltage levels
- 20 Volume icon: Displays the volume level
- 21 Pairing icon (Tx-5B or Tx-10B only): Appears when the transmitter and locator are connected via iLOC
- 22 Bluetooth icon (Bluetooth Tx models): Indicates status of Bluetooth connection. A flashing icon means pairing is in progress

2.3 Using the menu

The RD8000 locator and transmitter menus allow you to select or change system options. Once entered, the menu is navigated using the arrow keys. Navigation is consistent on both the transmitter and the locator. In the menu the options will appear in the bottom left-hand corner of the display. Note that when browsing the locator menu, the  and  keys act as left and right arrows. When browsing the transmitter menu the  and  keys act as left and right arrows. The right arrow enters a submenu and the left arrow selects the option and returns to the previous menu.

2.3.1 Navigating the locator menu

- 1 Press the  key to enter the menu
- 2 Use the  or  keys to scroll through the menu options
- 3 Press the  key to enter the option's submenu
- 4 Use the  or  arrows to scroll through the submenu options
- 5 Press the  key to make a selection and return to the previous menu
- 6 Press the  key to return to the main operation screen









2.3.2 Locator menu options

Below is an annotated list of menu options available in the RD8000 locator.

VOL	Adjust the speaker volume from 0 (mute) to 3 (loudest)
LOG	Delete or send saved survey measurements data and enable or disable the communication channel
BT	Enable, disable, reset or pair Bluetooth connections. Also defines the protocol used when connecting to a PDA
GPS	Select an external GPS module or enable or disable the internal one – RD8000 locators (GPS models only)
CDR	CD Reset – Only available when in CD mode
UNITS	Select metric or imperial units
CAL	Displays the date of the last calibration or eCert calibration validation
MARKR	Enable or disable the marker locator or individual utility markers
LANG	Select menus language

POWER	Select power frequency: 50 or 60Hz
ANT	Enable or disable antenna modes with the exception of Peak
FREQ	Enable or disable individual frequencies
ALERT	Enable or disables <i>StrikeAlert</i>
BATT	Set battery type: ALK, NIMH or LIION
COMP	Enable or disable display of the Compass feature.

2.3.3 Navigating the transmitter menu

- 1 Press the  key to enter the menu
- 2 Use the  or  keys to scroll through the menu options
- 3 Press the  key to enter the option's submenu.
- 4 Use the  or  keys to scroll through the submenu options
- 5 Press the  key to confirm selection and return to the previous level or exit the menu
- 6 Press the  key to return to the main operation screen

2.3.4 Transmitter menu options

Below is an annotated list of menu options available in the RD8000 transmitter.

VOL	Adjust the speaker volume from 0 (mute) to 3 (loudest)
FREQ	Enable or disable individual frequencies
BOOST	Boost transmitter output for a specified period of time (in minutes)
LANG	Select menus language
OPT F	Enable or disable <i>SideStep auto</i>
BATT	Set battery type: ALK, NIMH or LIION – Also select Eco mode for alkaline batteries only
MAX P	Allows the transmitter to output its maximum wattage
MODEL	Specify the model of your locator
MAX V	Set the output voltage
BT	Enable, disable or pair Bluetooth connections (Bluetooth models only)

Section 3 - Operation

3.1 First use

For safety reasons, RD8000 locators are shipped with the Lithium-ion battery packs disconnected. The transmitter D-cells and the optional Li-ion battery pack are packed separately.

On the locator:

To connect the Li-ion battery pack open the RD8000 battery compartment and plug the battery lead into the battery connector.

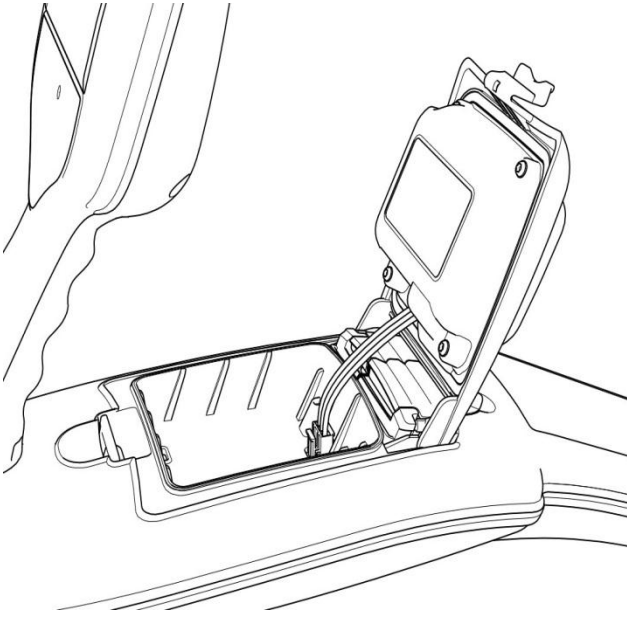



Figure 3.1 Li-ion battery pack connection

On the transmitter:

To fit the D-cells batteries in the transmitter, unlatch the accessory tray. The battery compartment is located underneath the transmitter body. Use the turnkey to unlatch the battery compartment. Insert eight D-Cell Alkaline or NiMH batteries.

3.2 Powering up

To switch the locator or the transmitter on, press the  key.

When you power up the locator or transmitter, they will perform an LCD segment check. It will then display the model number followed by the software version. This information is important if you need to contact Radiodetection technical support or update your locator to the latest software.

3.2.1 Power Options

The RD8000 marker locator range is provided with a rechargeable Lithium-ion (Li-ion) battery pack as standard. The locator can also be powered using good quality D-cell alkaline or NiMH-batteries.

Transmitters can be powered by D-cell alkaline batteries (as standard), D-cell NiMH batteries, or by an optional accessory Li-ion battery pack. Alternatively, you can power the transmitter from a mains or vehicle power source using a Radiodetection supplied optional accessory adapter.

Battery status

The locator and transmitter display provides a battery level indicator (refer to the diagrams in Sections 2.1 and 2.2). When battery replacement is necessary, the display shows a flashing battery icon.

Refer to appendix 14.6 for some indicative operating times.

NOTE: Prolonged use of high power output on the transmitter will reduce battery life.

You must fully charge your locator and optional transmitter battery pack before their first use

Recharging the locator Li-ion battery pack

To recharge the locator battery pack, connect the battery charger to the DC input connector on the front of the battery pack.

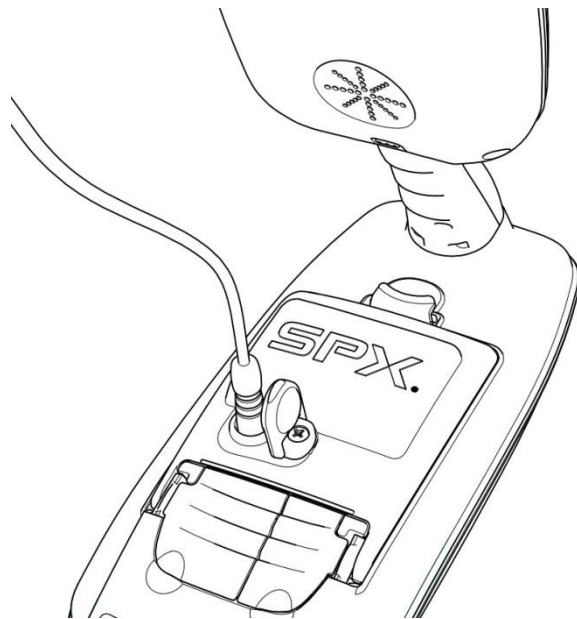

Figure 3.2 Charging the locator Li-ion battery pack

For more information about recharging batteries refer to the instructions that came with your charger.

⚠ WARNING! Do not heat the rechargeable battery pack above 60°C (140°F) as this will damage the battery's thermal fuses.

Recharging the transmitter Li-ion battery pack

To recharge the battery pack, remove the pack from the transmitter and connect the transmitter battery charger.

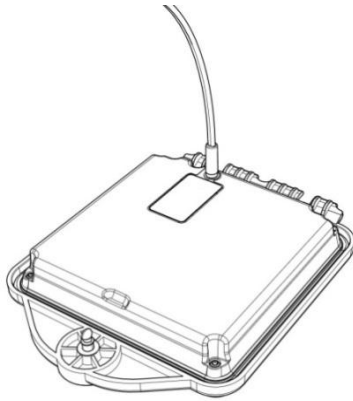

Figure 3.3 Charging the transmitter Li-ion battery pack

For more information about recharging batteries refer to the instructions that came with your charger

Using the D-cell locator battery holder

The locator can also be powered by three D-Cell Alkaline or NiMH batteries.

NOTE: When installing batteries always observe the correct battery polarity as indicated on the battery tray.

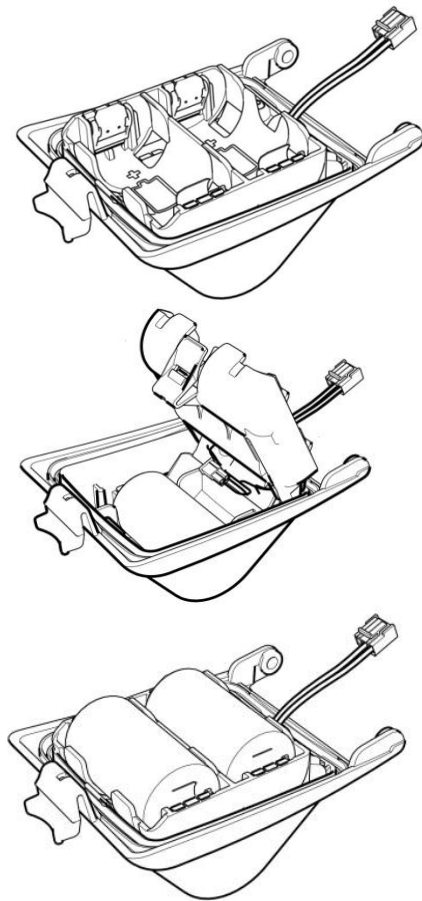

Figure 3.4 Locator D-cell holder

To insert the D-cells:

- 1 Open the cell tray and insert 1 D-cell
- 2 Close the tray and insert 2 D-cells

To remove / fit a battery holder:

- 1 Open the battery compartment using the release catch
- 2 Un-plug the battery lead connector (fig.3.1)
- 3 Lift the accessory cover slightly (fig 3.5)



Figure 3.5 Lifting accessory cover

- 4 Press the battery retaining latch inwards (fig 3.6)

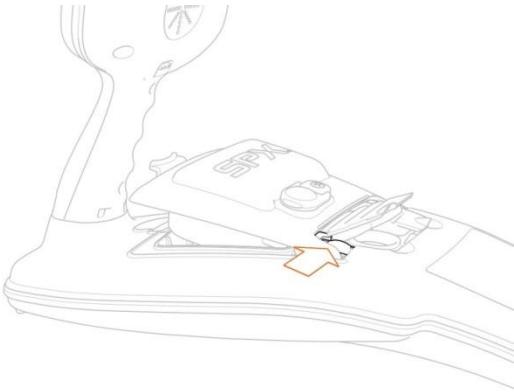

Figure 3.6 Pressing retaining latch

- 5 Rotate the battery pack away and up from the latch (fig3.7)

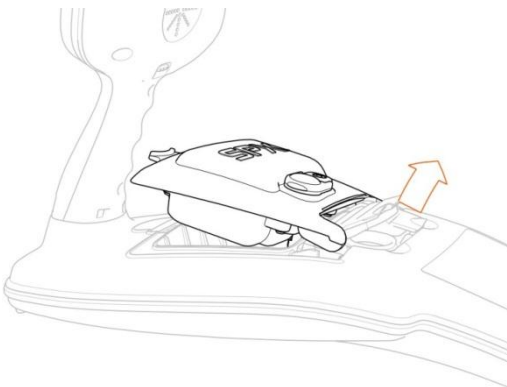

Figure 3.7 Rotating the battery pack

- 6 Repeat on the other side to release the battery pack completely

To fit the battery holder follow the steps above in reverse order.

Transmitters, all models

To replace the batteries on the transmitter, unlatch the accessory tray. The D-Cell battery tray (see figure 3.4 on page 17) is located underneath the transmitter body. Use the turnkey to unlatch the battery compartment. Remove the spent batteries and insert eight D-Cell Alkaline or NiMH batteries.

3.3 Shutting down

To switch the locator or transmitter off, press and hold the  key until the screen blanks off.

NOTE: The locator will automatically power off if no keys are pressed after a five minute duration.

3.4 System setup

The RD8000 locator and transmitter settings can be accessed via the menu. Once in the menu it is possible to change settings according to your personal preferences and operating requirements. Some examples of setting changes are shown below.

Please refer to the locator and transmitter menu options for more information.







NOTE: These procedures refer to both the transmitter and locator unless stated otherwise.

Before changing settings, ensure the locator or transmitter is switched on by pressing the  key for two seconds.

3.4.1 Language

The locator and transmitter support a number of languages. You can specify your preferred language using the menu system.

To select your preferred menu language:

- 1 Press the  key to enter the menu
- 2 Scroll to the **LANG** menu using the  or  keys
- 3 Press the  key (on the locator) or the  key (on the transmitter) to enter the LANG menu
- 4 Scroll up or down to select your preferred language
- 5 Press the  key to accept your selection and return to the main menu.
- 6 Press the  key to return to the main operation screen.







3.4.2 Battery type

RD8000 locators and transmitters support Li-ion, Alkaline or NiMH batteries.

By default your RD8000 locator battery type is set to Li-ion.

It is important that you set the system to match the currently installed battery type to ensure optimal performance and correct battery level indication.

To set your battery type:







- 1 Press the  key to enter the menu
- 2 Scroll to the **BATT** menu using the  or  arrows
- 3 Press the  key (on the locator) or the  key (on the transmitter) to enter the BATT menu
- 4 Scroll up or down to select the correct battery type
- 5 Press the  key to accept your selection and return to the main menu

- 6 Press the  key to return to the main operation screen

3.4.3 Power frequency (locator only)

Select the correct frequency (50 or 60Hz) for your country or region's power supply.







To change power frequency on the locator:

- 1 Press the  key to enter the menu
- 2 Scroll to the **POWER** menu using the  or  keys
- 3 Press the  key to enter the POWER menu
- 4 Scroll up or down to select the correct frequency
- 5 Press the  key to accept your selection and return to the main menu
- 6 Press the  key to return to the main operation screen

3.4.4 Measurement Units (locator only)

The RD8000 marker locator allows you to work in Metric or Imperial (US customary) units.









To select your preferred units:

- 1 Press the  key to enter the menu
- 2 Scroll to the UNITS option using the  or  keys
- 3 Press the  key to enter the UNIT submenu
- 4 Scroll up or down to select **METRE** (for metric) or **IMP** (for imperial) units
- 5 Press the  key to accept your selection and return to the main menu
- 6 Press the  key to return to the main operation screen

3.4.5 Enable / Disable frequencies

The locator and transmitter support a wide range of frequencies and there may be times when some of these frequencies are not used. It is possible to quickly enable or disable frequencies using the menu system.

To enable or disable frequencies:

- 1 Press the  key to enter the menu
- 2 Scroll to the **FREQ** menu using the  or  keys
- 3 Press the  key (on the locator) or the  key (on the transmitter) to enter the FREQ menu
- 4 Scroll up or down to select the frequency
- 5 Press the  key (on the locator) or the  key (on the transmitter) to enter the frequency
- 6 Scroll to OFF or ON using the  or  keys

- 7 Press the  key to accept your selection and return to frequency menu.





- 8 If you wish to make any further changes follow steps 4 to 6. If you do not wish to make any further changes press the  key twice to return to the main operation screen.

3.4.6 Marker locator

By default the marker locator is enabled or disabled by lowering or folding the marker loop antenna, item 9 in Section 2, figure 2.1





You can choose to disable the marker locator function.

To disable the marker locator:

- 1 Press the  key to enter the menu
- 2 Scroll to the **MARKR** menu using the  or  keys
- 3 Press the  key to enter the MARKR menu
- 4 Scroll to **OFF** menu
- 5 Press the  key to accept your selection and return to MARKR menu











If you have disabled the marker locator you can enable it again.

To enable the marker locator:

- 1 Press the  key to enter the menu
- 2 Scroll to the **MARKR** menu using the  or  keys
- 3 Press the  key to enter the MARKR menu
- 4 Scroll to **Auto** menu
- 5 Press the  key to accept your selection and return to MARKR menu

The marker locator can detect up to 9 different utility markers. If you wish you can enable or disabling them by using the menu system:

To enable or disable utility markers:





- 1 Press the  key to enter the menu
- 2 Scroll to the **MARKR** menu using the  or  keys
- 3 Press the  key to enter the MARKR menu
- 4 Scroll to the **AUTO** menu and press the  key
- 5 Scroll up or down to select a specific marker
- 6 Press the  key
- 7 Scroll to OFF or ON using the  or  keys
- 8 Press the  key to accept your selection and return to markers menu
- 9 If you wish to make any further changes follow steps 5 to 8. If you do not wish to make any further changes press the  key twice to return to the main operation screen.

3.4.7 Volume Control

The transmitter and locator feature an internal speaker to provide critical warnings or assist with cable and pipe location. The transmitter by default will also sound a pulsing tone to indicate that it is transmitting correctly.

To adjust audio level:

 **WARNING!** Muting audio on the locator will disable *StrikeAlert* audio alarm.

- 1 Press the  key to enter the menu
- 2 Scroll to the **VOL** menu the  or  arrows
- 3 Press the  key (locator) or the  key (transmitter) to enter the **VOL** menu

3.5 Dynamic overload protection™

Dynamic overload protection (DOP) allows you to locate accurately in areas with high levels of electromagnetic interference, such as sub-stations and beneath high-voltage transmission lines. DOP works by disregarding signal spikes that would otherwise overwhelm the RD8000 locator's digital signal processor. DOP is an integrated feature of all RD8000 locators. No action is required by the user.

NOTE: In cases of high levels of electromagnetic interference, the DOP will not be able to prevent the RD8000 from becoming overloaded. If the RD8000 becomes overloaded, users will be alerted by the mode flashing and both the depth and current measurements will be disabled.

3.6 TruDepth™ measurement

All RD8000 locators use TruDepth to estimate depth automatically when a good reading is established.

NOTE: TruDepth only indicates a locate depth when the locator is correctly oriented above the target line, cable or sonde, or in close proximity of the RF marker.

To help you orientate the locator correctly, you can use the locator's compass feature on the display – feature not available in marker mode.

Depth readings are displayed according to your preferred units of measurement.

For more information on measuring depth, please refer to Section 8.

3.7 Passive avoidance

Passive avoidance mode allows you to survey an area quickly by detecting power and radio signals

simultaneously. Passive avoidance is available on the PDLM and PTLM models only.

To select passive avoidance mode

- 1 Press the  key repeatedly until you find the **PASSIV** mode

Passive avoidance mode is now selected. Perform your survey as required.

Note: In Passive mode depth and current readings will not be displayed.

3.8 StrikeAlert™

StrikeAlert detects the possible presence of shallow power signals and warns the operator with a series of flashing asterisks on the display and an audible alarm, characterized by a rapid warbling sound.

RD8000 locators are shipped with *StrikeAlert* enabled by default, which can be disabled by accessing the *StrikeAlert* menu and setting *StrikeAlert* to OFF.

StrikeAlert will activate in Power and Passive mode only.

StrikeAlert can also be permanently disabled using the RD Manager PC software. Refer to its operation manual for further information.

 **WARNING!** Muting audio on the locator will disable *StrikeAlert* Audio alarm.

3.9 Antenna modes

The RD8000 locator supports seven antenna modes to suit your particular application or the local environment. These modes are:

- **Peak mode**
- **Single antenna mode**
- **Null mode**
- **Combined Peak / Null mode**
- **Guidance mode**
- **Marker mode**
- **Combined Peak / Marker mode**

For more information on selecting and using the various antenna modes to assist with cable and pipe location, please refer to Section 4 -.

3.10 Backlight

The transmitter and locator feature a backlight to improve LCD visibility when required. The locator's

backlight is controlled by an ambient light sensor and does not require adjustment by the user.

The transmitter's LCD backlight is activated whenever you press a key. The backlight will automatically switch off after a few minutes.

3.11 Bluetooth wireless

All RD8000 marker locators feature a Bluetooth wireless module as standard, providing the ability to connect to compatible devices such as transmitters (Tx-5B or Tx-10B only) or handheld devices running a compatible application.

Refer to Section 5 for further information about Bluetooth wireless connections and how to pair your devices.

NOTE: The RD8000 marker locator wireless features maybe subject to national and or local regulations. Please consult your local authorities for more information.

! WARNING! Do not attempt any wireless connection in areas where such technology is considered hazardous. This may include: petrochemical facilities, medical facilities or around navigation equipment.

3.12 iLOC and SideStep

iLOC is a standard feature of all RD8000 marker locators.

iLOC lets you control a Bluetooth enabled transmitter (Tx-5B or Tx-10B) remotely using your locator. With iLOC you can adjust the output frequency, power settings and use *SideStep*.

SideStep allows you to change the output frequency on the transmitter. *SideStep* changes the selected frequency by several Hertz and automatically sets the locator's locate frequency to match the transmitter's output frequency.

iLOC commands are sent over a Bluetooth module that can operate at distances of up to 300m / 1000ft in direct line of sight.

See Section 5 for detailed explanation on how to use iLOC.







3.13 SideStep^{auto}

SideStep^{auto} allows the transmitter to calculate the optimum frequency based on ground impedance. The transmitter uses this information to optimize the active frequency. *SideStep^{auto}* helps to improve locate accuracy by determining the best signal. *SideStep^{auto}* can also help to prolong battery life.







NOTE: *SideStep^{auto}* will only work in direct connection mode.

3.13.1 Using SideStep^{auto}

To enable *SideStep^{auto}*:

- 1 Press the  key to enter the menu
- 2 Scroll to the **OPT F** menu using the  or  keys
- 3 Press the  key to enter the OPT F menu
- 4 Scroll up or down to the **START** option
- 5 Press the  key to start *SideStep^{auto}* and exit the OPT F Menu
- 6 Press the  key to exit the menu

To disable *SideStep^{auto}*

- 1 Press the  key to enter the menu
- 2 Scroll to the **OPT F** menu using the  or  keys
- 3 Press the  key to enter the OPT F menu.
- 4 Scroll up or down to the **EXIT** option
- 5 Press the  key to disable *SideStep^{auto}* and exit the OPT F menu
- 6 Press the  key to exit the menu

NOTE: You can also disable *SideStep^{auto}* just by changing frequency.



3.14 Transmitter power output

The transmitter supports several power output modes to help you select the optimal settings for your requirements whilst helping to prolong battery life.

3.14.1 Adjusting power output

NOTE: On iLOC enabled models, you can adjust the transmitter's power output remotely using the locator. For more information, please refer to Section 6.



To adjust the power output:





Press the  or  keys to increase or decrease power output

3.14.2 Boost (Tx-10(B) only)

Boost allows the Tx-10 transmitter to output its maximum output power. Boost mode can be set to operate for a specified period of time.

To configure boost:

- 1 Press the  key to enter the menu
- 2 Scroll to the **BOOST** menu using the  or  keys

- 3 Press the  key to enter the BOOST menu
- 4 Set the BOOST duration using the  or  keys. You can choose 5, 10, 15 and 20 minute periods or ON for continuous operation
- 5 Press the  key to accept your changes and exit the BOOST menu
- 6 Press the  key to exit the menu

To enable boost:

- 1 First configure the boost duration using the procedure above
- 2 Press and hold the  key until **BOOST** appears on the transmitter LCD
- 3 The transmitter will automatically exit boost mode after the selected duration

To disable boost:

- 1 Press the  key to disable boost

3.15 Transmitter Eco mode









When using alkaline D-Cells in Tx-5(B) and Tx-10(B) transmitter models you can extend the effective use of the batteries by enabling Eco mode.

In Eco mode the power output of the transmitter reduces when the batteries can no longer provide the required output power.

When eco mode is active and the power output has been reduced, the display flashes between POWER and the current output power level.

The transmitter will emit three beeps every time the power is reduced. It will then continue emitting two beeps every minute whilst it operates at a reduced power level.

To enable Eco mode

- 1 Press the  key to enter the menu
- 2 Scroll to the **BATT** menu using the  or  keys and enter it by pressing the  key.
- 3 Scroll up or down to the **ALK** menu and enter it by pressing the  key.
- 4 Select **ECO** and press the  key to enable the Eco mode option
Or
Select **NORM** and press the  key to disable Eco mode.
- 5 Press the  key to exit the menu

3.16 Measure mode

The transmitter has the capability of providing impedance measurements by determining the resultant impedance across the crocodile clips of the direct connection lead while connected to the utility. These measurements can be useful when assessing sheath fault severity. It is also possible to measure potential voltage that may be present on utilities to warn of potentially dangerous or harmful voltages present.

In measure mode the measurement is derived from an AC signal applied to the utility from the transmitter

3.16.1 Impedance and voltage measurements

1. Connect the direct connection leads to the utility and switch on the transmitter.
2. Hold down the  key until **MEAS** is displayed and the measuring icon is activated.

The transmitter display will now indicate the voltage level measured across the connection leads.

3. Press the  key once and the display will indicate the impedance measured across the connection leads.

The measurement icon will display the following symbols:

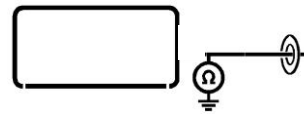





Figure 3.8 Impedance and voltage measurements

4. To exit **MEAS** mode hold down the  key until the display reverts back to the normal operating screen.

3.16.2 Impedance measurements using active frequency

1. Connect the direct connection lead to the utility and switch on the transmitter.
2. Select the preferred frequency and output the signal.
3. Press the  key once and the display will indicate the impedance measured across the connection leads and also the output power of the transmitter.
4. Press the  key once to return to the normal operating screen.

3.17 CALSafe

CALSafe enabled RD8000 locator models (logging and GPS units only) are equipped with a system which does disables them once they are beyond the expected service / calibration date.

When the unit is within 30 days from the service due date the unit will display at startup the number of days left. The locator will stop functioning on the service due date.

You can edit the CALSafe service due date or disable this function using the RD Manager PC software. Refer to its operation manual for further information.

3.18 Automatic Logging

RD8000 logging and GPS locator models offer a powerful data logging system which records all the instrument's critical parameters (including GPS position, if available) and warnings in its internal memory every second.

The automatic logging system is always active and cannot be disabled. Its memory is capable of storing at least 1 years' worth of normal usage data – based on 4 hours operation per day, 5 days per week and 20 days per month.

Logs can be retrieved using the RD Manager PC application for usage analysis and survey validation. Refer to its operation manual for further information.





3.19 GPS

The RD8000 locator can be paired to an external GPS module or use its internal GPS module (GPS models only) to be able to detect and store its latitude, longitude and accurate UTC time alongside its location data using SurveyCERT or the automatic logging system (GPS and logging models only).

The presence of GPS data allows for the data to be mapped easily and to export and save the information directly into GIS systems.

3.19.1 GPS menu

To enter the GPS menu:



- 1 Press the  key to enter the menu
- 2 Scroll to the **GPS** menu using the  or  keys
- 3 Press the  key to enter the GPS menu

There are 5 options:

- **RESET:** Select YES to reset the internal GPS (GPS models only)
- **INT:** Select this to use the internal GPS if present

- **EXT:** Select this to use the GPS from a compatible paired device
- **OFF:** Select this to switch off the internal GPS module and save battery
- **SBAS:** Select this to switch **ON** or **OFF** SBAS (Satellite-based augmentation systems) mode.
In this mode the GPS can improve its accuracy (North America only).

Note: When SBAS is ON the GPS system will take longer to lock

- **EXT:** Select this to exit the GPS menu
- 4 Press the  key to accept your changes and exit the GPS menu
 - 5 Press the  key to exit the menu

3.19.2 Internal GPS

RD8000 GPS models have an internal GPS module. When internal GPS is enabled, it will automatically try to “lock” onto a number of GPS satellites as soon as the RD8000 unit is turned on.

The time required for the GPS module to lock onto the GPS system varies depending on how long it has passed since the last time it was used and on the presence of any obstacles (like high buildings, trees, etc.) that may affect the line of sight to the sky.

If the unit has not been used for several days the time to first fix may take up to several minutes.

The RD8000 locator display provides a number of icons indicating the presence of an internal and active GPS and when this has locked to the GPS system, the quality of the signal received or numbers of satellites received.

The accuracy of the GPS module is affected by the number of satellites received and best accuracy is only reached when the signal quality is at its maximum.

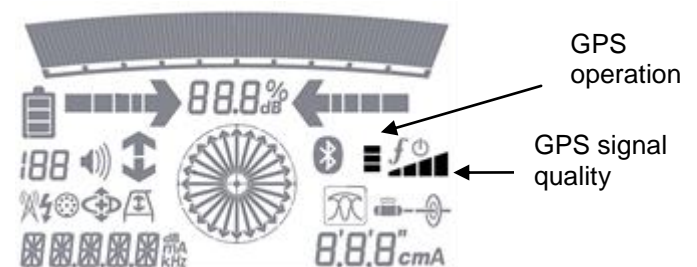

Figure 3.9 GPS Icons

The LCD GPS operation icons provide visual information about the status of the internal GPS module:

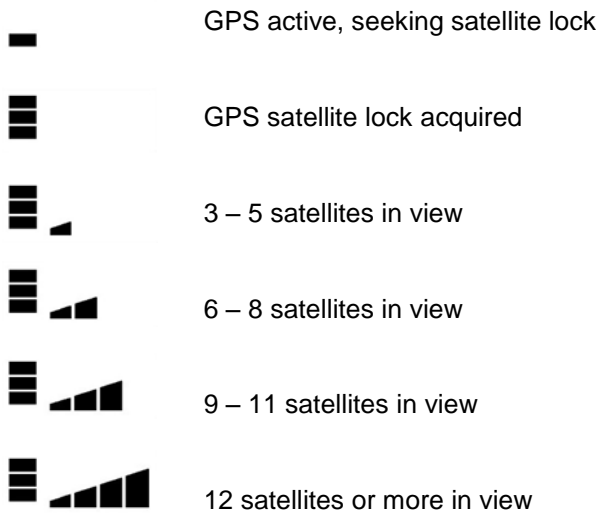

Figure 3.10 GPS status and satellites in view

Section 4 - Locating cables and pipes

This section introduces the principals and techniques of locating buried cable and pipe utilities with the RD8000 system. For more information on the theory of cable and pipe location, please refer to *ABC & XYZ of locating buried pipes and cables*, which is available to download from www.radiodetection.com

4.1 Frequencies

The RD8000 marker locator supports a range of active and passive frequencies.

For a complete list of supported frequencies, please refer to the table in Appendix 14.8.

4.1.1 Passive frequencies

Passive frequency detection takes advantage of signals that may be present on buried metallic conductors. The RD8000 marker locator supports four types of passive frequencies: **Power**, **Radio**, **CPS** and **CATV** signals.

You can detect these frequencies without the aid of a transmitter if they are present on the utility you are surveying.

4.1.2 Active frequencies

Active frequencies are applied to a buried conductor using the transmitter. The transmitter can apply a signal using three methods:

Direct connection

In direct connection, you connect the transmitter output directly to the utility. The transmitter will then apply a discrete signal which you can locate using the locator. This is the preferred method of applying a transmitter signal to a utility and in the majority of applications will apply a stronger signal to the utility, which may increase the locate distance.

To directly connect to a non-energized conductive utility:

- 1 Switch the transmitter off
- 2 Connect the direct connection lead into the transmitter accessory socket
- 3 Clip the red connection lead to the utility ensuring that the area around the connection is clean and that a positive connection is achieved
- 4 Clip the black connection lead as far away as possible and at 90° to the ground stake or suitable ground point nearby ensuring that a positive connection is achieved
- 5 The display will show the Direct connection lead connected icon

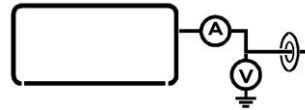

Direct connection lead connected

For more information about signal clamps and other direct connection accessories, please refer to Section 10.

⚠ WARNING! Direct connection to live conductors is POTENTIALLY LETHAL. Direct connections to live conductors should be attempted by fully qualified personnel only using the relevant products that allow connections to energized lines.

⚠ WARNING! The transmitter is capable of outputting potentially lethal voltages. Take care when handling the terminals, connection leads and ground stake, notify other technicians working on the line of the hazard and guard exposed conductors to prevent accidental contact.

Induction

In this mode of operation the transmitter is placed on the ground over or near the survey area. If a direct connection lead is not plugged into the transmitter, it will automatically go into induction mode. In this mode, only frequencies applicable for induction mode will be made available as the  key is pressed.

Once activated the transmitter will induce the signal indiscriminately to any nearby buried conductors.

Please note that these signals will also be airborne and it is advisable to keep the distance between the transmitter and locator at least 10m / 30' – this distance may need to be increased, particularly if depth measurements are taken.

Clamp

The optional signal clamp can be connected to the transmitter and clamped around a cable or pipe to apply the transmitter signal. This method of applying the transmitter signal is particularly useful on insulated live wires and removes the need to disconnect the supply to the cable. Clamps are available up to 8.5" / 215mm in diameter.





⚠ WARNING! Do not clamp around uninsulated live conductors

⚠ WARNING! Before applying or removing the clamp around a power cable, ensure that the clamp is connected to the transmitter at all times.

4.1.3 Selecting Frequencies

It is important to select the correct or appropriate frequency for your particular application. For more information see Section 6 or refer to the application note “ABC & XYZ of Locating Buried Pipes and Cables”, which is available as a free download from www.radiodetection.com

To select a frequency on the locator:

- 1 Press the  key to cycle through available frequencies
- 2 Alternatively, hold down the  key and press the  or  keys to cycle up or down the range of frequencies

If using an active frequency you must also set your transmitter to output the matching frequency.

You can change your transmitter's output frequency manually using your transmitter's keypad or automatically using iLOC (Bluetooth transmitters only).

To manually select a transmitter output frequency:

- 1 Press the  key to cycle through available frequencies

To change frequencies using iLOC, please refer to Section 6.

NOTE: Some frequencies require that you connect an accessory, for example an A-Frame, before the frequency is available.

NOTE: Some RD8000PTL model frequencies are only available in the Tx-10B transmitter model.

4.2 Antenna modes

The RD8000 system supports five antenna modes, exclusively dedicated to locating cable and pipes, and to suit your particular application or the local environment. These are:

- Peak mode
- Single antenna mode
- Null mode
- Combined Peak / Null mode
- Guidance mode



4.2.1 Peak mode

Peak mode provides the most sensitive and accurate mode for location and depth measurement. It provides a sharp peak response with a corresponding small decrease in sensitivity. Peak mode cannot be disabled using the menu.

In peak mode the following indicators are displayed by the LCD:

- Depth
- Current
- Signal strength
- Compass

To select peak mode:



- 1 Press the  key until the peak mode icon  is displayed on the LCD

4.2.2 Single antenna mode

In Single Antenna mode, the RD8000 locator will detect with higher sensitivity over a wider area than peak mode. This is particularly useful for locating deep utilities quickly and indiscriminately in single antenna mode the following indicators are displayed by the LCD:

- Depth
- Current
- Signal strength
- Compass

To select single antenna mode:

- 1 Press the  key to select your preferred frequency
- 2 Press the  key until the single antenna mode icon  is displayed on the LCD.



4.2.3 Null mode

Null mode is used to verify a locate signal in environments with limited or no electromagnetic distortion.

In null mode the following indicators are displayed by the LCD:

- Signal strength.
- Compass.
- Right and left arrows.

To select null mode:

- 1 Press the  key until the null mode icon  is displayed on the LCD

Null mode gives a null response when it is directly over the line. The sharp, null response can be easier to use

than the peak response but is vulnerable to interference and should not be used for locating, except in areas where there is no interference present (See 4.2.4 Combined Peak / Null mode).

4.2.4 Combined Peak / Null mode



Peak / Null mode gives you the advantages associated with these modes simultaneously.

Use the proportional arrows to place the locator above the NULL point. If the peak response is not at a maximum then this is evidence of a distorted field. If the peak response is at its maximum level where the NULL point is located then there is no or very limited distortion present. At this point, peak mode may be selected to obtain depth and current information.

In Peak / Null mode the following indicators are displayed by the LCD:

- Proportional right and left arrows
- Signal strength
- Compass
- Current
- Depth

To select Peak / Null mode:

- 1 Press the  key until the Peak / Null mode icon  is displayed on the LCD

4.2.5 Guidance mode

Guidance mode offers good performance in distorted fields and provides three indicators to guide the user towards the target line.

The Left and Right Proportional Arrows become shorter as the locator approaches the target, and the Target Position Indicator will move towards its central position. The Signal Strength reading will also reach its maximum value when the locator is positioned above the target.

Any deviation from all three indicators showing the target position in the same location could signal the presence of a distorted field.



In Guidance mode the following indicators are displayed:

- Proportional left and right arrows.
- Target position indicator
- Signal strength.
- Compass.
- Current
- Depth

NOTE: The depth and current values will display automatically, although these values will not be

accurate until the locator is directly over the target line and correctly orientated.

To select Guidance mode:

- 1 Press the  key until the Guidance mode icon  is displayed on the LCD

4.3 Compass

The LCD compass provides a visual indication of the direction of the target cable, pipe or sonde. The compass is available for all frequencies apart from Power, Radio and Passive.

4.4 Trace

Line tracing can be accelerated by switching the locator to Null mode.

Move the locator left and right while walking along the path of the line to observe the null directly over the line and a peak response to each side of the line. As you move the locator over the line, the left and right arrows (and an accompanying tone) will indicate if the target line is to the left or right of the locator.

Periodically switch to peak mode, locate the target line, and verify its exact position.

4.5 Pinpoint

Locating a target line in peak mode accurately defines the position of a target line after it has been traced and its position is approximately known. Start with medium output power from the transmitter, medium frequency on the transmitter and locator, and peak mode on the locator.

Set the locator sensitivity to approximately 50%.

NOTE: it may be necessary to adjust the sensitivity level throughout the pinpointing to keep the bar graph on scale.

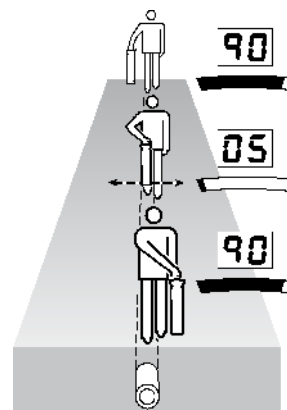

Figure 4.1: Line Tracing

Figure 4.2: Pinpointing a target line

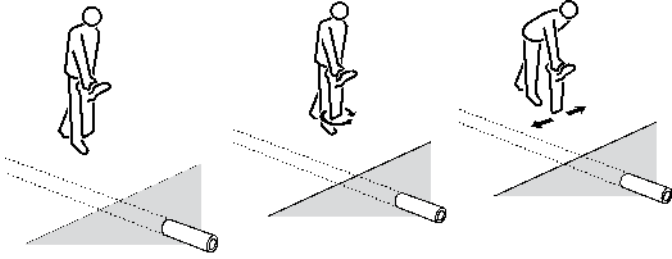
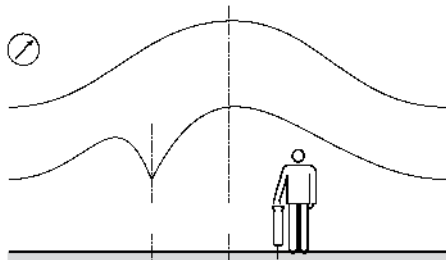

Figure 4.3: Pinpointing with Peak/Null



- 1 With the antenna perpendicular to the line, make traverses across the line. Define the point of maximum response.
- 2 Without moving the locator, turn it round as if it is on a pivot. Stop at the point of maximum response.
- 3 Hold the locator vertical with the antenna just above the ground and move the locator from side to side across the line. Stop at the point of maximum response.
- 4 With the end of the antenna close to the ground, repeat steps 2 and 3.
- 5 Mark the position and direction of the line.

Repeat the steps of the procedure to increase pinpoint accuracy.

Switch to null response mode and move the locator to find the null position. If the position of the peak and the null pinpoints correspond, it can be assumed that the pinpoint is accurate. The pinpoint is not precise if the marks do not correspond, but both marks will show an error to the same side. True line position will be close to peak position.

The line lies half the distance to the other side of the peak position as the distance between the peak and the null positions.

4.6 Sweep and search

There are a number of techniques available for locating unknown lines in an area. Using these techniques is particularly important before conducting any excavation work to help ensure that buried lines are not damaged.

4.6.1 Passive Sweep

A passive sweep is used to locate any Power, Radio, CATV or CPS signals that may be radiating from buried conductors.

To perform a passive sweep:

- 1 Press the **F** key to select the passive frequency you wish to locate. You can select from the following passive frequencies:
 - Power
 - Radio
 - CATV
 - CPS
 - PASSIV: simultaneously detects Power and Radio signals where present.
- 2 Adjust the sensitivity to maximum; reduce the sensitivity to keep the bar graph on scale when there is a response.
- 3 Traverse the area in a grid search (Figure 4.4), at a steady walk, and hold the locator comfortably with the antenna in line with the direction of movement and at right angles to any lines that may be crossed.

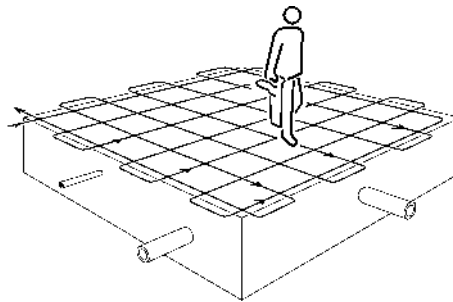

Figure 4.4: Passive sweep

Stop when the locator response rises to indicate the presence of a line. Pinpoint the line and mark its position. Trace the line out of the area being searched. Resume grid search in the area.

In some areas there may be a confusing amount of 50 / 60Hz power signals. Lift the locator 50mm from the ground and continue the sweep.

Switch the locator to Radio Mode if the locator supports this feature. Increase sensitivity to maximum and repeat the above grid search procedure over the area. Pinpoint, mark, and trace out any lines that are located.

In most, but not all areas, radio mode will locate lines that do not radiate power signals and a grid search should be made in both power and radio modes.

4.6.2 Inductive search

An inductive search procedure is a more certain technique for locating unknown lines. This type of search requires a transmitter and locator and two

people. This type of search is referred to as a 'two person sweep'. Before starting the sweep, define the area of search and the probable direction of lines crossing the area. Ensure the transmitter is switched on in induction mode.

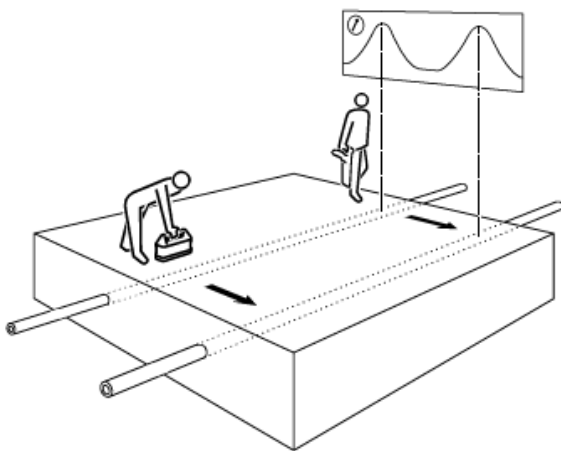

Figure 4.5: Inductive search

The first person operates the transmitter and the second person operates the locator. The transmitter induces a signal onto lines as it passes over them and the lines are then detected with the locator at a suitable distance away from the transmitter.

A suitable distance is around 15 meters – although this will depend upon the transmitter used and the level of induction power used.

Hold the transmitter with its length aligned with the assumed direction of any lines.

The second person holds the locator at the start of the area to be searched and with the locator antennae at right angles to the probable direction of the buried lines. Set the locator sensitivity level as high as possible without the locator picking up any airborne signals directly from the transmitter.

When the transmitter and locator are in line both operators start to move forward in parallel. The operator with the locator sweeps it backwards and forwards, keeping the locator vertical, as they proceed in parallel with the transmitter. This method allows for misalignment of the transmitter, locator and buried line.

The transmitter applies the strongest signal to the lines directly below it, which are then located with the locator. Move the transmitter from side to side to establish the highest signal which indicates that the transmitter is also directly above the line(s).

Mark the ground at the point of each peak signal detected with the locator. Repeat the search along any other possible paths of lines.

Once the positions of any lines have been marked, reverse positions, place the transmitter over and along each line in turn, and trace the line out of the search area.

Section 5 - Locating RF Markers

The RD8000 marker locator enables users to locate most common RF utility markers. These are also referred to as Electronic Marker System (EMS) and Omni Markers™.

RF markers are used to identify buried utilities and are generally located, at regular intervals, directly on top of the utility they are marking.

The markers are passive devices which resonate at a specific frequency when energized by the marker locator. Each utility is identified by a specific frequency and color.

Display abbreviation	Utility	Color	Frequency
PWR*	Electrical Power	Red	169.8kHz
H2O	Water	Blue	145.7kHz
PDE	German Power	Blue / Red	134.0kHz
SAN	Sanitary	Green	121.6kHz
TEL	Telephone / Telecoms	Orange	101.4kHz
GAS	Gas	Yellow	83.0kHz
CTV	Cable TV	Black / Orange	77.0kHz
PUR	General / Non-drinkable water	Purple	66.35kHz
PFR	French Power	Natural	40.0kHz

5.1 Marker Mode

Folding down the special marker loop antenna, on the front of the RD8000 locator, activates the Marker mode.

In Marker mode, the locator can be used to locate a specific marker or to locate a buried conductor and a marker simultaneously.

5.1.1 Entering Marker mode

To enter marker mode fold down the marker antenna loop. The locator will enter the Marker mode and display the marker icon and identify the marker selected.

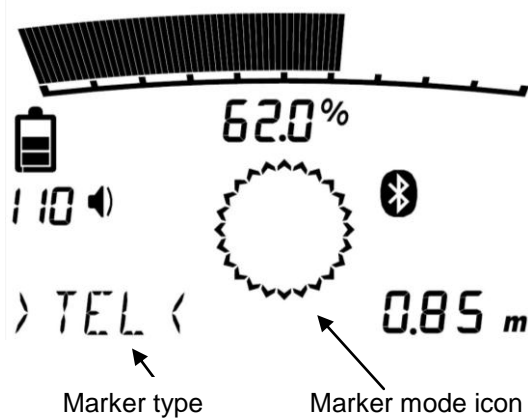

Figure 5.1 Marker mode

*Use of the red Electrical Power (PWR) marker locate mode is subject to radio licensing restrictions for Short Range Devices in the EU and possibly other countries. It is the responsibility of the user to ensure that the red Power (PWR) marker locate mode is only enabled in countries where radio licensing restrictions do not apply at the operating frequency of 169 kHz. If required and permitted, use the RD Manager software package to enable this frequency.

Markers can be disabled using the Marker setup menu, see Section 2.3.2 . Disabled markers are not available to be selected and will not be displayed.

Markers can also be permanently disabled in the locator by using RD Manager. Refer to its operation manual for further information.

NOTE: The locator defaults to the last marker used

5.1.2 Changing RF marker type

- 1 Press the key to select the marker you wish to locate.

The abbreviations for each type of marker are indicated in the table below:

5.1.3 Combined mode

In combined mode the locator is used to locate buried conductors (pipes or cables) and the selected marker simultaneously.

In this mode, the left / right arrows indicate the buried conductor position while the bargraph, numeric display, and audio response indicate the amplitude of the received marker signal.

To enter combined mode:

- 1 Press the  key to select dual mode. The display will show the null locate features.

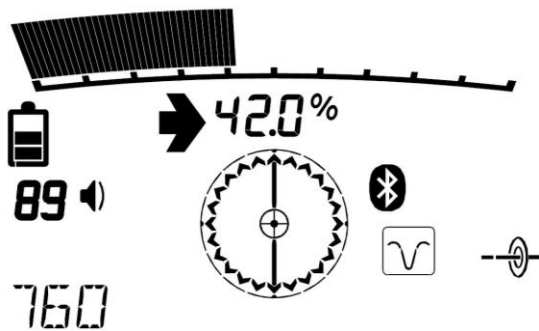



Figure 5.2 Combined mode

5.2 Locating RF markers

5.2.1 Single mode locating

Use this mode when locating a RF marker only, for example, when locating markers used with water or gas plastic utilities.

Proceed as follows:

- 1 Select Marker mode, see 5.1.1
- 2 Select the type of marker you are trying to locate
- 3 Carry out a sweep of the area in which the markers are located to ensure that all markers are located. (set to maximum sensitivity)
- 4 Use the  or  keys to set the locator's sensitivity to low and pinpoint the marker(s)



⚠ CAUTION: The radio signals generated by marker locators may be reflected by other marker types. This may cause the locator to show a response to a different utility marker type, if it is close enough.

- 5 Once you have located a specific utility marker, scroll through all available marker types by pressing the  key to ensure that no other marker types display a greater response and to confirm that you have located the correct utility marker type.





NOTE: If you cannot locate the marker ensure that you have selected the correct marker type for the utility you are trying to locate and have the sensitivity set to maximum.

5.2.2 Combined mode locating



Use this mode when locating the marker and conductor simultaneously.

In this mode no null mode sensitivity adjustments can be made whilst marker sensitivity adjustments are possible by using the  or  keys.

To set up the system for dual locating proceed as follows:

- 1 Select the same frequency on the locator as used by the transmitter.
- 2 Pull down the RF marker antenna on the locator. The marker symbol is displayed.
- 3 Press the  key to select the specific marker you are trying to locate.
- 4 Press the  key to select dual mode. The display shows the null symbol and location arrows, and the locate frequency is shown in place of the marker type.
- 5 Locate the conductor using the left / right arrows as normal but sweep the area either side of the conductor to ensure that all markers are located. When an RF marker is approached the volume and bargraph reading will increase and decrease as the marker is passed. Use the  or  keys to set the locator's RF marker sensitivity as required to help pinpointing the marker.

⚠ CAUTION: The radio signals generated by marker locators may be reflected by other marker types. This may cause the locator to show a response to a different utility marker type, if it is close enough.

- 6 Once you have located a specific utility marker, switch back to Single mode locating, by pressing the  key, and scroll through all available marker types by pressing the  key to ensure that no other marker types display a greater response and to confirm that you have located the correct utility marker type.

NOTE: If you cannot locate the marker ensure that you have selected the correct marker type for the utility you are trying to locate.

NOTE: A thorough scan of the area as described in 4.5 is recommended when locating for cable and pipes.

Section 6 - Depth and current readings

6.1 TruDepth™

The RD8000 locator provides automatic depth of buried conductors, sondes and RF utility markers when the locator is correctly orientated above the target line sonde or in close proximity of the RF marker.

Current readings are also displayed simultaneously if the locator is orientated correctly (feature not available in sonde, RF utility markers or passive frequency modes).

Depth and current readings are automatically displayed simultaneously, but if the locator is not correctly orientated neither reading will be displayed.

Depth range and accuracy varies depending on the type of target (cable, sonde, or RF marker), its depth and by external environmental factors like electromagnetic noise or interferences.

⚠ WARNING: The accuracy of depth measurement is subject to a number of factors and is meant as a guide only. Exercise caution when performing any excavation.

Refer to appendix 14.7 for further information about depth range and accuracy.

The depth measurement is to the center of the pipe, cable, sonde or RF marker. The best readings are typically detected from signals outputted by a transmitter rather than from passive sources.

The RD8000 marker locator is capable of determining cable depth when locating passive power signals. However passive signals on lines are less suited for measuring depth because accuracy is questionable due to the passive signal being present on more than one line.

⚠ WARNING! Do not make depth measurements near bends or tees in the line. Go at least 5m (16ft) from a bend for best accuracy.

6.1.1 TruDepth for RF Markers

The RD8000 locator is capable of automatically estimating the depth of a buried marker when it is in close proximity to it.

In order to get the best possible accuracy it is important to ensure the locator is directly above the marker position by pinpointing its exact position first as described in paragraph 8.2.

6.1.2 TruDepth for buried conductors or sondes

TruDepth and Compass

It is important to note that the RD8000 locator will only display depth and current (in applicable modes) when the locator is correctly orientated above the target line, cable or sonde. To ensure the locator is correctly orientated, use the Compass feature.

When locating lines, make sure the Compass display is in the North / South orientation position.

When locating sondes (see Section 8.5.5), make sure the Compass display is in the East / West orientation position.

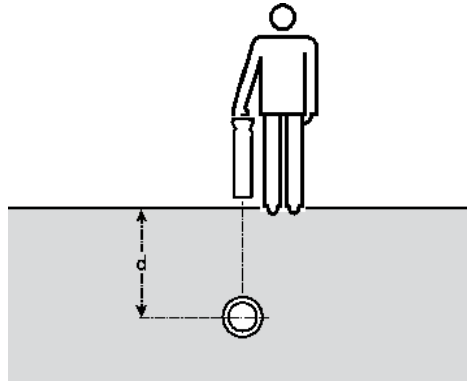
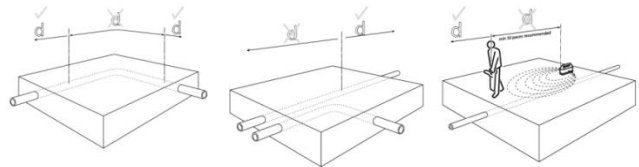

Figure 6.1: Taking a depth reading

To avoid signal distortion, do not apply the signal by induction. If direct connection or signal clamping is not possible, place the transmitter at least 15m (49ft) from the point of any depth measurements.

Depth measurements may not be accurate if there is audible interference or if part of the transmitter signal has coupled to a nearby line.

Confirming the peak position coincides with a null position indicates that the position is suitable for making a depth estimate.



Figures 6.2: Depth readings

- Pinpoint the target line accurately with the locator
- Check the locator is directly over the line, the antennae are at right angles to it and the locator is vertical. Adjust sensitivity level to bring the bar graph indication on scale

- Press the depth button to alternate between depth and current readings

If the ground appears to radiate a strong field, perhaps near a radio station, check depth by holding the bottom of the antenna 50mm (2") above the ground and subtract this reading from the indicated depth.

6.2 Verifying depth measurements

Check a suspect or critical depth reading by lifting the locator 50mm (2") above the ground and repeating the measurement. If the measured depth increases by the same amount it is a good indication that the depth reading is correct.

When locating for a conductor or sonde, depth measurements should be accurate to $\pm 5\%$ if conditions are suitable. However, you may not always know if the conditions are suitable so the following techniques should be used to check critical readings:

- Check that the route of the line is straight for at least 2 meters (6½ft) to either side of the measurement point.
- Check that the signal response is reasonably constant over the 15 meter distance to the transmitter and make depth measurements to either side of the original point.
- Check that there are no adjacent lines carrying a significant signal within 1 to 2m (3 to 6½ft) of the target line. This is the most common source of error of depth measurements as a strong signal coupled to an adjacent line can often introduce $\pm 50\%$ error.
- Make several depth measurements at points slightly displaced from the line's apparent position. The shallowest indication will be the most accurate and will also indicate the line's position most accurately.

6.2.1 Rough depth calibration check

This paragraph describes several quick and easy ways of verifying that the depth reading on the locator when used for markers or conductors and sondes is within acceptable limits.

Please refer to this if you are getting inaccurate depth readings from a cable or pipe for which you know the approximate depth. Inaccurate depth readings could be the result of the locator picking up a stronger signal such as another cable or pipe running in close parallel to the target pipe or cable.

When locating for RF Markers

- 1 Set the locator to marker mode and select the correct marker type.
- 2 Place the marker on top of a non-metallic object, such as a cardboard box, on the ground and away from any buried lines or other sources of interference.

- 3 Place the locator horizontal, at a distance equal to half the maximum depth range distance for the marker you are using (for example 700mm / 27½" for the center of the marker ball to the bottom of the locator).
- 4 Note the depth as indicated on the locator LCD.
- 5 Compare this reading with the depth reading on the locator.

Refer to appendix 14.6 to verify if the Locator is operating within specification.

When locating for conductors or sondes

There are two ways of checking the calibration of the locator in the field. Both methods require the use of a transmitter:

Method 1

Place the transmitter on top of a non-metallic object, 18" / 500mm in height or more, on the ground and away from any buried lines. Switch the transmitter on in induction mode. Hold the locator with the blade horizontal and pointing towards the front of the transmitter and approximately five meters from the front of the transmitter.

- 1 Switch the locator on.
- 2 Select the same frequency as is selected on the transmitter but make sure that this frequency is in the sonde mode.
- 3 Move the locator from left to right and when the bargraph reading is at its peak note the depth as indicated on the locator Measure the distance from the base of the locator to the center of the transmitter using a tape measure.
- 4 Compare this reading with the depth reading on the locator.

The locator can be considered accurate if the difference between the depth reading on the locator and the distance measured with the tape is less than 10%.

Method 2

- 1 Apply a signal to a cable or pipe of known depth.
- 2 Locate the cable or pipe; the locator will display depth on the LCD automatically.
- 3 Compare the depth reading on the locator with the actual depth.

NOTE: The accuracy of depth measurement is subject to a number of factors and is meant as a guide only. Exercise caution when performing any excavation.

6.3 Current Readings

6.3.1 Identification using current measurements

Measuring current value on a line helps confirm the identity of the line and may provide information about the condition of cable insulation or pipe coating.

6.3.2 About current measurements

The transmitter applies a signal or current onto a target line. The current decreases in strength as the distance from the transmitter increases. This rate of decrease depends on the type of line and on soil conditions. Regardless of the type of line and the frequency being used the rate of decrease should be regular with no sudden drops or changes. Any sudden or abrupt current change indicates that the line or its condition has changed.

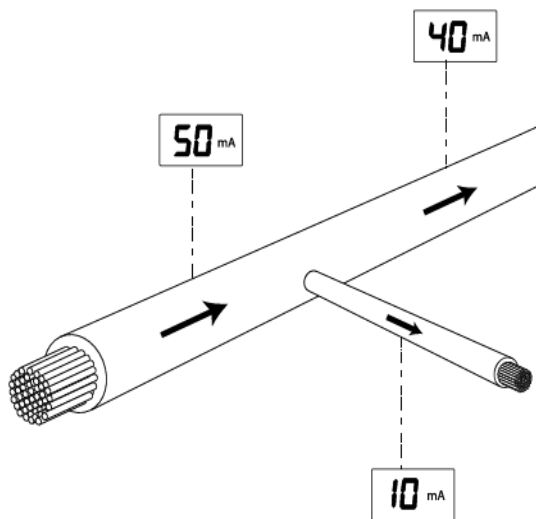
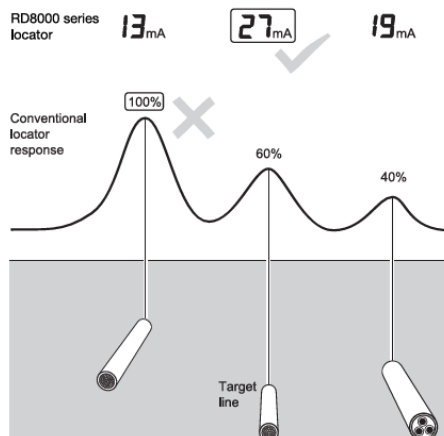
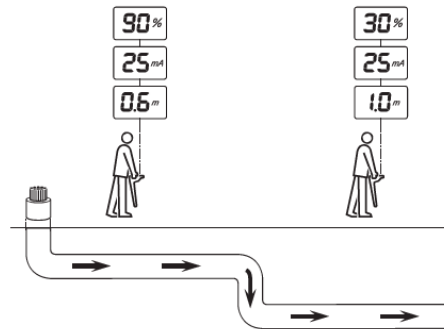
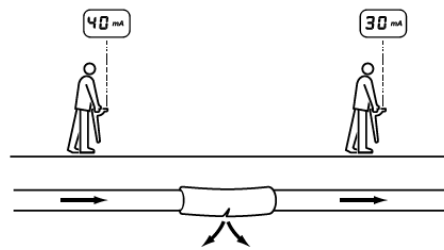

Figure 6.3 Current readings

In congested areas, where there is more than one line, the locator may sometimes detect a stronger signal from an adjacent line to which the signal has coupled or shares common grounding because it is nearer the surface. Although current measurement compensates for depth, signal response will be less as the depth increases.

The line with the highest current measurement, rather than the line giving the strongest response, is the target line to which the transmitter signal has been connected.

Measuring current provides useful information about the position of bends and intersections. Measuring current after a tee will indicate the main line that pulls more current along its greater length.



Figures 6.4 – 6.6 Taking current readings

6.3.3 Applying a transmitter signal

The transmitter signal can be connected, clamped or induced to the target line in the same way as the signal for line tracing is applied.

⚠ WARNING! Direct connection to live conductors is POTENTIALLY LETHAL. Direct connections to live conductors should be attempted by fully qualified personnel only using the relevant products that allow connections to energized lines.

6.3.4 Signal current measurements

Pinpoint the line and confirm the accuracy of the peak pinpoint with a null pinpoint. Check the locator is directly over the line, with the antennae at right angles to it and vertical.

The locator will automatically estimate and display depth on the LCD.

A signal coupled to a nearby line may distort the accuracy of the measurement. If the accuracy of the

reading is suspect, sweep the area to check if other nearby lines are radiating the signal. If other signals are causing interference, it may be necessary to make the current measurement at another point along the line.

Both antennae are needed to make a current measurement and locator accessory antennae such as a normal clamp or stethoscope cannot be used. Because current measurement is a function of depth, it is only available in the locating modes. It is also available with Current Direction (CD) clamps.

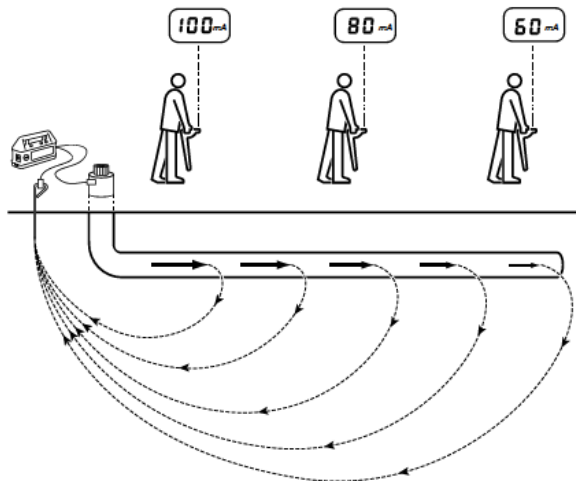

Figure 6.7: Current readings using transmitter signals

Section 7 - General Locating tips

7.1 Eliminating services

7.1.1 Induction

If several conductors are running in parallel, and it is not possible to connect a transmitter, each line may be located separately. Proceed as follows:

- 1 Perform a sweep of the area to find the position and number of conductors in the area.
- 2 Map the direction in which the conductors are going.

To trace the lines:

- 1 Select induction mode on the transmitter.
- 2 Select the same frequency as on the locator.
- 3 Place the transmitter on its side and in line with a conductor
- 4 Ensure the conductor is directly below the transmitter
- 5 This will null the signal directly below the transmitter and, in addition, enable the other conductors to be located
- 6 Locate each conductor and mark its position
- 7 Move the transmitter down the route and continue locating and marking.
- 8 Trace each conductor out of the search area until the target can be accurately located.

7.1.2 Unwanted signal coupling

Unwanted coupling of the signal from the target line to another nearby line is one of the most common location problems. It leads either to an error in the marked position and depth of the target line or to marking the wrong line. A certain degree of coupling is unavoidable in many situations but there are ways in which a careful user can reduce coupling and increase location reliability.

- Avoid applying the signal by induction. The signal may be coupling to more than one line directly from the transmitter. Use the signal clamp where possible.
- Identify points where lines may be bonded or in close proximity to each other. Work toward these points rather than away from them. For example, if gas and water pipes are bonded within a building, apply the signal at the valves or access points in the road rather than in the building.

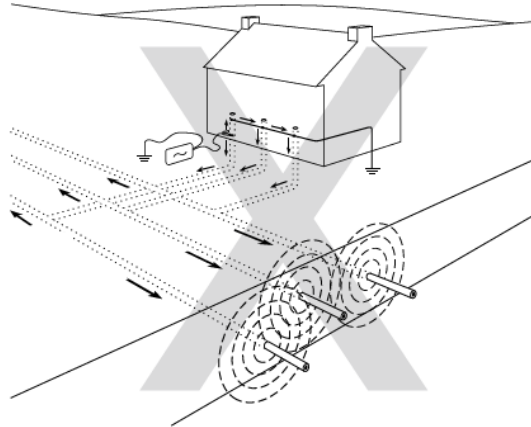
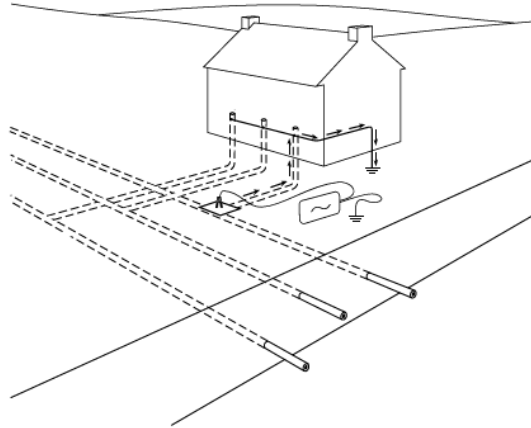
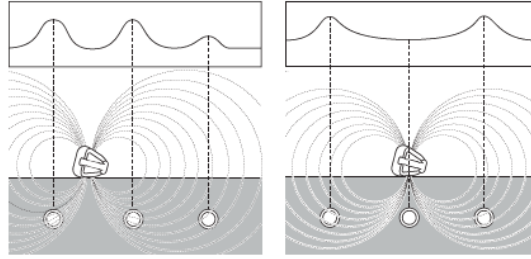

Figures 7.1 – 7.4: Interference from services

- Reduce coupling to a parallel line by using a low signal frequency where available
- Return signal flowing on another line. Use a double-ended connection to by-pass the ground return if possible
- Choose a signal application point where the line is furthest from other lines and not in a congested area
- When using single-ended connection, site the ground stake as far from the target line as possible and away from other buried lines

- Avoid using existing structures for ground connections; other buried lines may be bonded to them

A bad ground connection or just laying the ground lead on the surface at right angles to the line may result in less coupling than a good ground provided long distance tracing is not required.

7.2 Signal grounding

7.2.1 Manhole covers

Sometimes when locating, it is not possible to insert the ground stake into the earth, for example, when locating on hard ground such as roads. In this case, the ground return can be made by attaching the ground lead to the metal frame of a manhole.

7.2.2 Using lighting columns

Direct connecting to a metal, street-lamp column is almost as effective as connecting to the cable sheath itself. Normally the cable sheath is bonded to the metal column, therefore a simple connection onto the column enables the user to locate the street lighting quickly and safely without having to call out a technician from the lighting company.

If the lighting column is made from concrete make the transmitter connection to the cable sheath unless the cable is earthed to the inspection doorframe. Connection to the cable sheath applies the transmitter signal for a considerable distance enabling the locator to trace cables feeding illuminated street furniture as well as other street lights.

⚠️ WARNING! The live cable connector is for use only by operators licensed or permitted to work on live cables.

The use of a street light column as a means of applying a signal to other power cables on the same electric circuit is a possibility. The signal may be weak using this method because it may have travelled some distance back to the sub-station and out again on the other system. With the locator used on a high sensitivity setting it is often possible to locate a cable, which would otherwise have been difficult or inconvenient to energize with the transmitter signal.

7.2.3 Finding a good ground point

When using a direct connection, it is important to get the best possible grounding for the transmitter. This provides the lowest resistance ground path and the best output signal. If it is not possible to use the ground stake the following are examples of good alternative ground points:

- Metal manhole covers
- Metal drainage grates
- Metal railings
- Metal fence posts

7.3 Double-ended connections

Large diameter water pipes and gas distribution pipes that are laid in sections sometimes have insulated joints between the sections and can be difficult to locate using a single ended connect. This is because when using a single ended connection ground return, signals can often cause confusion by returning to the transmitter along other lines. The problem sometimes occurs when return signals appear stronger than on the target line, usually because the target line is deeper than the line carrying the return signal, or the return path may be a better electrical conductor than the target line.

Applying a double-ended transmitter connection is a useful technique for positively tracing and identifying a target line in a situation such as a heavily congested industrial site, provided there are access points at each end of the line.

7.3.1 Making a double-ended connection

Connect the transmitter to an access point on the target line. The transmitter ground is connected with a long cable to another access point further along the line. A complete circuit is achieved without using ground as a current return path. The long cable should be kept as far away as possible from the expected route of the line. Radiodetection supplies 50 meter and 200 meter extension cables for this purpose.

This method of applying the transmitter signal is ideal for positive identification of a target line. When a connection has been made to two points on the same line, the same level of current should be detectable around the circuit. The locator display should remain constant if the depth of the line does not change.

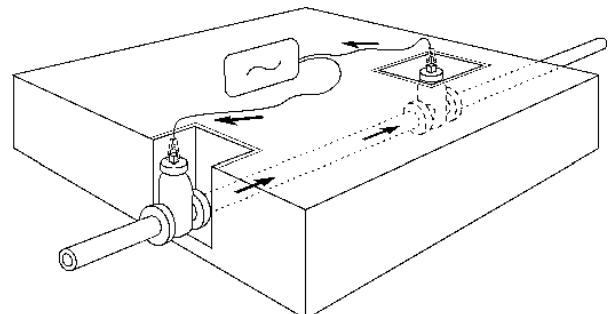

Figure 7.5: Making double-ended connections

Section 8 - Using Accessories

8.1 About accessories

Both the transmitter and locator are compatible with a wide range of accessories.

When an accessory is connected, the locator or transmitter will recognize it and will enable the mode appropriate to the accessory. For example, attaching an A-Frame to the RD8000 Marker locator will automatically switch the locator to fault-find mode and limit the number of available frequencies to those that are compatible with the A-Frame. The LCD will also display an icon of the accessory and will remove any nonessential icons from the screen.

Radiodetection supply an accessory sheet with pictures and details of all applicable accessories which is available on the Radiodetection website.

For a full list of supported accessories that are available for purchase, please refer to Appendix 13.6

8.2 Headphones

Radiodetection supplies an optional headphone set for the RD8000 locator. The headphones feature an adjustable headband to ensure a tight fit when used in the field. The accessory headphones also feature volume adjustment for both left and right speakers.

Connect the 3.5mm headphone jack into the locator's headphone socket, which is located next to the accessory panel.

⚠ WARNING! Before wearing headphones, lower the locator's volume levels to help prevent damage to your hearing.

⚠ WARNING! Wearing headphones may impede your awareness to dangers in the field such as moving traffic or other heavy machinery. Exercise caution!

8.3 Locator clamps

A locator clamp is used to positively locate and identify a cable when several cables are running close together.

A target cable can be identified in a chamber, on a tray or other access point by fitting a clamp to the locator and examining each cable in turn. Signal strength response shown on the locator display should be noted for each cable.

8.3.1 When to use clamps

Clamps can be used where:

- Several cables or pipes run in close proximity to each other.
- A cable or pipe is accessible at an inspection hole or manhole.

NOTE: The standard clamp cannot be used with CM or CD. A special CM / CD clamp is available.

8.3.2 Connecting a clamp

- 1 Put the clamp connector into the accessory socket on the front of the RD8000 Marker locator.
- 2 Place the clamp around the pipe or cable and switch the locator on.
- 3 Set the frequency to the same as that on the transmitter.
- 4 Put the clamp around each cable in turn and note the bar graph response. Compare the strength of response from each cable. The cable with a substantially stronger response than the others will be the cable to which the transmitter signal has been applied.

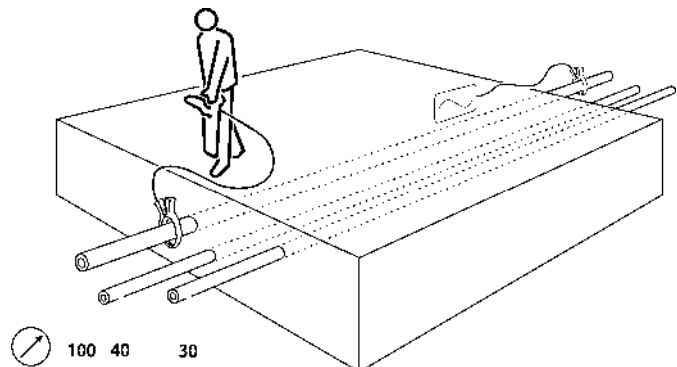

Figure 8.1: Connecting clamps

To ensure that the target cable has been correctly identified, reverse the positions of the transmitter and locator and check that the strongest response is still received from the target cable by the locator in its new position.

8.3.3 Available locator clamps

Standard clamp

The clamp plugs into the locator accessory socket and is used for cable identification at points where the cable can be accessed. The standard clamp is suitable for cables up to 100mm (4") diameter.

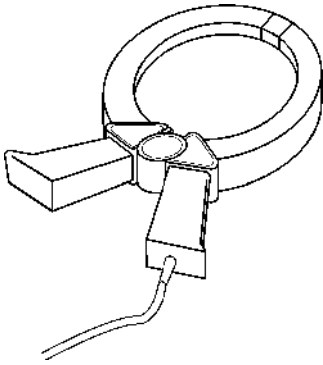

Figure 8.2: Standard Clamp

Small clamp

The small clamp performs the same function as the standard clamp but is useful in cramped situations where there is insufficient access for the standard clamp.

The small clamp is suitable for cables up to 50mm (2") diameter.

Current Direction (CD) and Current Measurement (CM) clamp

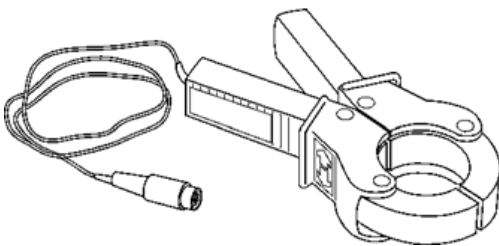

Figure 8.3: CD / CM Clamp

The CD / CM clamp plugs into the accessory socket of the locator and enables CD and CM measurements to be made on individual cables.

This accessory is used to identify a particular cable that is bunched with several other cables or in close proximity to other cables. The combination of direction

current and current magnitude is extremely useful for identification purposes.

8.4 Transmitter clamps

The transmitter clamp fits around a pipe or cable and safely applies a signal to a live insulated cable without interrupting or disconnecting the supply. The clamp applies a very discriminating signal to a target line with reduced coupling to other lines. A clamp can sometimes be a more effective method of applying the signal than direct connection.

The target line will carry the strongest signal. The other lines will carry the weaker return signal. If the system comprises only two conductors, they may carry equal signals.

⚠ WARNING! Do not clamp around uninsulated live conductors

⚠ WARNING! Before applying or removing the clamp around a power cable, ensure that the clamp is connected to the transmitter at all times.

The clamp may buzz or vibrate if it is placed around a power cable that has significant net current flow. This is normal and does not harm the equipment.

8.4.1 Connecting the clamp

- 6 Plug the clamp into the transmitter output socket.
- 7 Put the clamp around the pipe or cable and ensure that the jaws are closed. Switch the transmitter on.
- 8 The display will show the Clamp connected icon



The line should be grounded (earthed) on each side of the clamp for the signal to transfer to the line. Ground the line if necessary. An insulated cable may be traced even if it has no actual ground connection, providing a reasonable length is buried either side of the clamp to provide capacitive coupling to ground (earth).

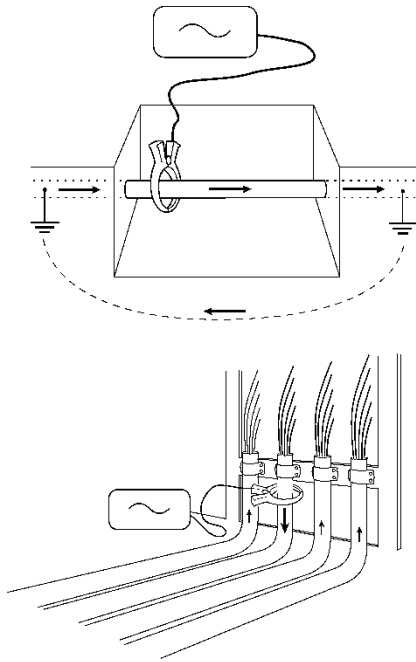

Figures 8.4 – 8.5: Connecting transmitter clamps

NOTE: It is not necessary to make a ground connection from the transmitter when using the clamp.

8.4.2 Available transmitter clamps

Although transmitter and locator clamps look the same, they have different internal windings. To prevent the wrong clamp being connected, transmitters and locator clamps have plugs of a different orientation.

Standard signal clamp

The standard clamp applies the transmitter signal very selectively and effectively to a target cable up to 100mm (4") in diameter using frequencies from 8kHz to 200kHz

The standard and small clamps have a double spring action for positive toroidal contact.

Small signal clamp

The small signal clamp is useful for applying signals from 8kHz to 200kHz to a target cable in a pedestal or other place with limited space. The clamp is suitable for cables up to 50mm diameter.

Current Direction (CD) clamp

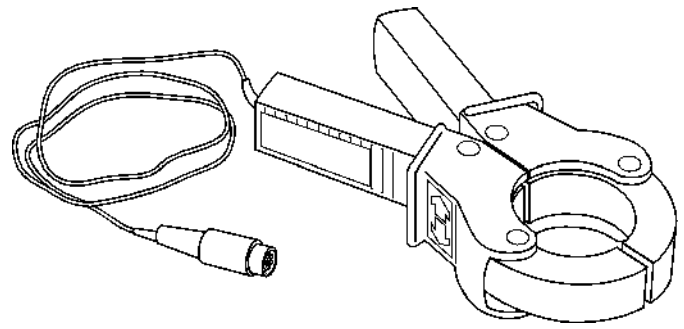

Figure 8.6: CD clamp

The CD clamp plugged into the accessory socket of the transmitter enables CD signals to be applied to individual cables.

⚠ WARNING! The transmitter must only be connected to live services using the appropriate accessory such as a plug connector or live cable connector.

8.5 Sondes

8.5.1 What is a Sonde

A sonde is a self-contained battery operated transmitter used for tracing the paths of pipes, ducts, sewers and drains and in the precise location of blockages or collapses. The sonde can be fitted to a flexible rod for insertion or pushing through pipes etc. and the smaller diameter sondes can be used in conjunction with jetting machines and blown through the duct. A suitable Radiodetection locator can then be used to locate the sonde

8.5.2 Choosing a suitable sonde

Radiodetection offers a wide range of sonde to suit most applications: From the 1/4" / 6.4mm diameter S6 33kHz microsonde which, with a range of 6.6" / 2m, targets fiber-optic micro ducting or other small non-conductive pipes, to the 33kHz Super Sonde, which with a depth range of 49.2 feet / 15m targets deep sewer pipes.

Consult the precision locate accessory range brochure or web page on www.radiodetection.com for a full list of all available sondes and their technical specifications.

Check that the sonde has sufficient range for the application and is dimensionally small enough and sufficiently robust for the application. Ensure that the frequency of the sonde corresponds with the locator frequency; the locator will not locate the sonde unless the frequencies are the same. Sondes are marked with their transmitting frequency. Ensure that the means of

propelling the sonde is available together with the correct fittings and couplings.

8.5.3 Preparation

Insert a new battery into the sonde. A new battery or a freshly recharged battery should be used at the beginning of each day and preferably at the start of each new job.

Before inserting the sonde, check that the sonde and locator are at the same frequency and working correctly. To do this, place the sonde on the ground at a distance from the locator that is equal to the rated depth of the sonde. Point the locator at the sonde with the antenna in line with the sonde (the opposite of using the locator to locate a line) and check that the bargraph reading exceeds 50% at maximum sensitivity.

8.5.4 Propelling a sonde

Sondes have a male thread at one end for connecting to drain rods, or to other devices for inserting and propelling the sonde along a drain or duct. Sondes may be floated along drains at the end of a tether and floats are available for fitting to the sewer sonde and super sonde. Sondes can be strapped to high-pressure water jets or similar devices used for cleaning, maintaining and inspecting drains. Sondes used in underground drilling and boring operations are normally housed in the boring or drill head behind the boring or drill bit.

8.5.5 Locating and tracing a sonde

Insert the sonde in the drain or duct access and locate it while it is still just in view at the drain or duct entrance. Hold the locator vertical directly over the sonde with the antenna in line with the sonde. Adjust the locator sensitivity so the bar graph reads between 60% and 80%.

The sonde radiates a peak field from the center of its axis with a ghost signal at each end of the peak. Move the locator a little way behind and then in front of the axis of the sonde to detect the ghost signals. Finding the two ghost signals positively confirms the locate. Reduce the locator sensitivity to lose the ghost signals but still indicate a clear peak response directly over the sonde. Locator sensitivity is now set for tracing the duct or drain unless the distance between sonde and locator changes.

Propel the sonde three paces along the drain or duct and stop. Place the locator over the supposed position of the sonde. Do not adjust the sensitivity level.

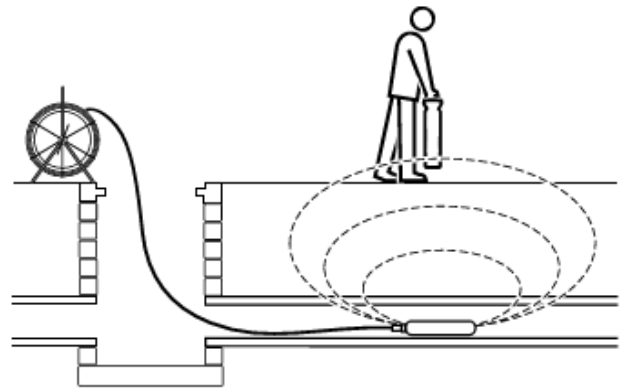

Figure 8.7 Sonde deployment

To locate a sonde:

- 1 Move the locator backwards and forwards and stop when the bar graph indicates a peak. You can use the LCD compass to orient the blade of the locator with the direction of the sonde.
- 2 Rotate the locator as if the blade is a pivot. Stop when the bar graph indicates a peak.

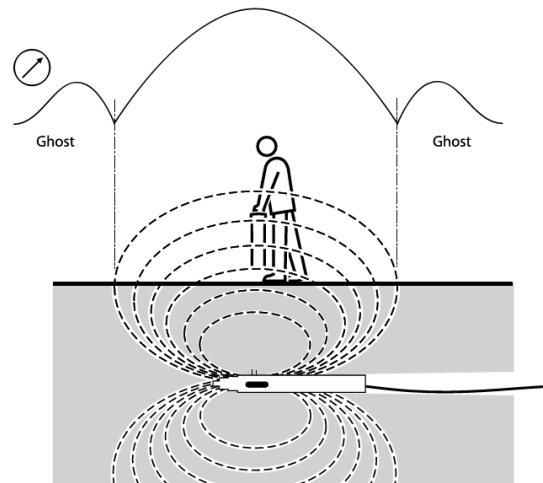

Figure 8.8 Locating a sonde

- 3 Move the locator from side to side until the bar graph indicates a peak.
- 4 Repeat 1, 2 and 3 with the antenna vertical and resting on or just above the ground. The locator should then be directly above the sonde with the antenna in line with it. Mark the position of the sonde and its direction.
- 5 Propel the sonde a further 1 or 2 meters, pinpoint, and mark the position. Repeat this pinpoint procedure at similar intervals along the line of the drain or duct until the survey is completed.

8.5.6 Checking sonde depth

The RD8000 locator will automatically display the depth of a located sonde providing the locator is correctly

oriented and positioned above the sonde. Using the LCD compass as a guide, rotate the locator until the compass indicates the sonde is in East / West position.

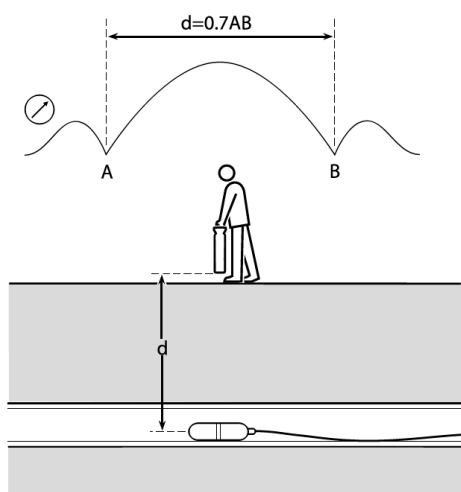

Figure 8.9: Calculating sonde depth

Calculation method

Pinpoint the sonde. Move the locator in front of the sonde and still with the antenna in line with it, increase sensitivity to find the peak of the ghost signal. Move the locator to behind the sonde ensuring that the locator blade is always in line with the sonde. Find the null positions A and B (See Figure 11.8). Measure the distance between them and multiply by 0.7 to give an approximate depth measurement.

8.5.7 FlexiTrace

The FlexiTrace is a traceable plastic covered fiberglass rod incorporating wire conductors and is used for locating small diameter, non-metallic pipes to a depth of 3 meters. The FlexiTrace can be inserted into a pipe or duct as small as 12 mm / 0.5 inch internal diameter with a minimum bend radius of 250mm. Batteries are not required, as the FlexiTrace is powered by the RD8000 Marker transmitter.

The FlexiTrace has a maximum power rating of 1W. When using the FlexiTrace with a Radiodetection Tx-5 or Tx-10 transmitter the output limit must be set to 1W in the MAX P menu and the output voltage limit set to LOW in the MAX V menu.

No settings are required for the Tx-1 transmitter.

⚠ WARNING: Failure to follow the Tx-5 or Tx-10 instructions above may result in the tip of the FlexiTrace becoming too hot to touch, resulting in risk of personal injury and damage to the equipment.

The FlexiTrace can be used in two modes: Sonde mode or Line mode. In sonde mode only the tip of the FlexiTrace is energized whilst in line mode its whole length is energized.

To use as a sonde, connect both transmitter leads to the FlexiTrace stud terminals. As the FlexiTrace

terminals are not color coded it does not matter to which terminals the leads are connected. To use the FlexiTrace in line mode, connect the red transmitter lead to one of the FlexiTrace terminals and connect the black transmitter lead to a suitable ground connection.

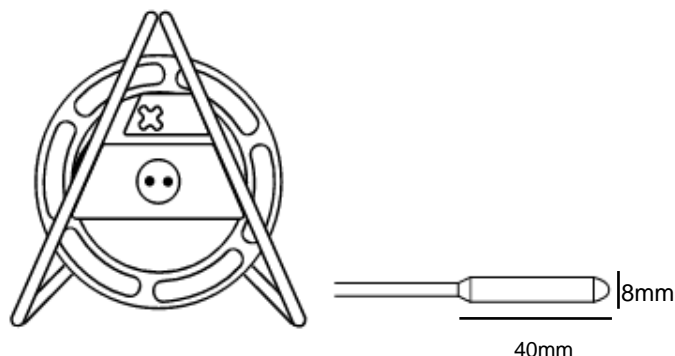

Figure 8.10: FlexiTrace

8.6 Stethoscopes

8.6.1 When to use a stethoscope

At times, it may not be possible to put a clamp around a cable because of congestion or because of inaccessibility. A stethoscope antenna should be used in the place of the clamp to identify cables.

8.6.2 How to use a stethoscope

Plug the stethoscope into the locator accessory socket. Press the concave head against each cable in turn to detect a maximum signal.

8.6.3 Types of stethoscope

Large stethoscope antenna

The large stethoscope antenna, which plugs into the locator accessory socket, is used for cable identification in situations where the cable is exposed. It is particularly useful for identifying heavy cables lying in a tray where it is not possible to fit a clamp. The concave detector head on the end of the insulated, flexible gooseneck is placed firmly against the cable to be identified. If there are a number of cables, the stethoscope antenna will give the strongest response from the cable to which the transmitter signal has been applied.

Small stethoscope antenna

The small stethoscope antenna has a 25mm (2") concave head at the end of a 2m (6½ft) lead. The small stethoscope can be screwed into an extension rod or used at the end of several extension rods joined together for identifying inaccessible small cables.

Miniature hi-gain stethoscope

The miniature stethoscope is similar to the small stethoscope but has no handle or facility for extension rods.

The miniature stethoscope can also be used as a miniature antenna for locations where the bulk of the locator makes it inconvenient for use, such as locating pipes or cables in walls.

CD stethoscope

In restricted areas, the CD stethoscope can be used to obtain current direction but not current measurement.

8.7 Submersible antenna

8.7.1 When to use a submersible antenna

Tracing buried pipes and cables across waterways and estuaries are frequent and critical locating applications. Less frequent but equally important is tracing and locating lines between the mainland and offshore islands. When locating pipes and cables the locator sensing antennae should be as close as possible to the target line so it is not practical to locate lines buried under a river or seabed from the surface. In most cases, it is necessary to measure the depth of cover to ensure the line is protected from dragging anchors or other underwater hazards.

The submersible, double depth antenna is suitable for use under water for tracing pipes or cables. There is a weight at the bottom of the antenna for stability and the unit has been pressure tested to IP68 to a depth of 100m (300ft).

The antenna is supplied with 10m of submersible marine umbilical cable as standard, but lengths of up to 100m can be supplied. The extra length enables the antenna to be carried by a diver on a riverbed or seabed while the locator is used in a surface vessel. It is crucial to have effective communication between the operator with the locator and the diver with the antenna.

Alternatively the antenna can be fastened to the end of a non-metallic boom from a barge and lowered to the riverbed or seabed.

8.7.2 How to use a submersible antenna

Apply the transmitter signal to the target line at an access point on the shore. The submersible antenna line for tracing the line underwater is plugged into the accessory socket of the locator. The locator is used onboard a boat, which should be positioned directly over the line. The transmitting signal should be by direct connection with the strongest possible signal and at the frequency that the submersible antenna is calibrated at. Make a ground connection about 50m (160ft) from the transmitter. Test the quality of signal on the line before locating on the water.

NOTE: The submersible antenna is calibrated to work at one frequency.

Tips for using a submersible antenna:

The user in the boat should be a specialist or have considerable experience using a locator so that they can give concise instructions to the diver.

It is prudent for the pair to practice working together on dry land before attempting to locate underwater. Using the antenna the diver should locate and trace a known line blindfolded receiving directions from the user with the locator out of sight of the line and the diver.

Because of rapid signal loss and a combination of large surface area and very conductive soil there may be problems applying a suitable signal for tracing a large diameter pipe. It may be necessary to use a high power, low frequency tracing signal.

It is necessary to define a method of recording target line position and depth before starting work in the boat or on the seabed.

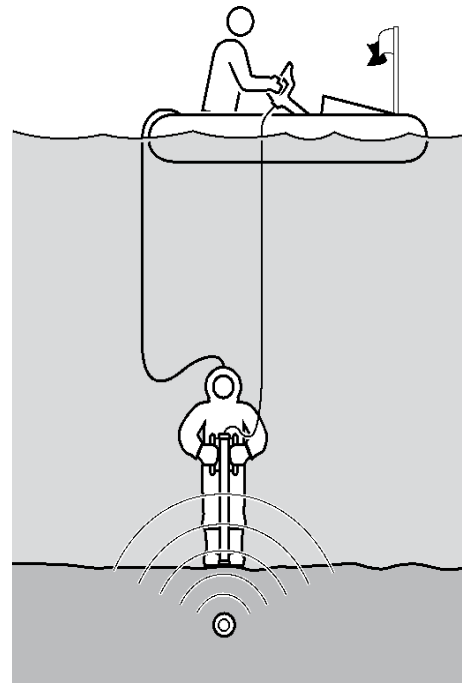

Figure 8.11: Using a submersible antenna

⚠ WARNING: The operator using the submersible antenna must be a properly licensed and experienced diver.

Section 9 - Fault-Finding

9.1 About fault-finding

The RD8000PDL and PTL are capable of locating cable to ground faults caused by damaged cable sheaths and can also be used to locate damage to insulation on pipelines. This process is known as Fault-Finding and uses specific fault find signals applied to the target.

Fault find signals can only be applied using direct connection method.

The accessory A-frame is used to locate cable sheath faults on power and telecom cables or insulation faults on pipelines. To use Fault-Find you will need the following equipment:

- RD8000 locator
- Tx-5 or Tx-10 transmitter
- Accessory A-frame with connecting lead
- Direct connection lead and earth stake

There are 2 types of signals that can be used for fault finding:

8KFF – useful for sheath faults on cables but can also be used on pipelines over shorter distances.

CD (only available on Tx-10) – this signal is very useful on pipelines and particularly useful on long distance pipelines. CD can also be used for locating sheath faults on cables.

9.2 Preparation

Using RD8000 standard locating techniques locate the cable or pipe for a short distance and trace and mark its route. Remove all earth bonds from the line to be traced during the fault-finding survey. If there are any earth bonds along the path the fault find signal may direct the user to this location as this will be the preferred path for the fault find signal to leak away into the ground and may result in the fault not being located.

9.2.1 Connecting the transmitter

- 1 With the transmitter switched off connect the direct connection lead into the transmitter accessory socket
- 2 Clip the red connection lead to the cable, cable sheath or pipe ensuring that the area around the connection is clean and that a positive connection is achieved
- 3 Extend the black connection lead as far away as possible and at 90° to the probable route of the target cable and clip the connector to the ground stake ensuring that a positive connection is achieved

NOTE: Always connect the black connection lead to a ground stake and not a water pipe or buried cable, as these may carry the signal.



9.2.2 Reference readings

It is good practice to obtain a reference reading from the ground stake before you attempt to locate a fault on a target line. Reference readings help to provide the following information:

- Severity of fault
- Survey interval

Before taking the reference reading set up the transmitter and locator as follow:

On the transmitter:

- 1 Select a fault-finding frequency using the  key
- 2 Use the  or  keys to increase or decrease the output signal level
- 3 If required you can use the BOOST setting if the fault is located on a high resistance cable or if the cable is long

 **WARNING!** By selecting 8KFF the transmitter will have the ability to output high voltages and a high voltage warning icon will appear on the transmitter's LCD.

On the locator:

- 4 Connect one end of the connection lead to the A-frame socket
- 5 Connect the other end to the locator accessory socket
- 6 The locator will automatically recognize the A-frame and display the A-frame icon on the LCD
- 7 Select a fault-finding frequency using the  key

NOTE: If the locator and transmitter are iLOC enabled then you can remotely control the transmitter using the locator. See Section 6 for more information.

Obtaining a reference reading:

Position the locator approximately 2m (6 feet) from the ground stake and push the A-frame spikes into the ground with the green spike towards the ground stake

Attach the locator to the A-frame by the retention hook. (If you are holding the locator separately, make sure that the locator is in line with the A-frame and is pointing towards the green spike.) The fault direction arrow should be pointing away from the ground stake. If it is not, make sure that the transmitter is connected

correctly (red connector to the cable and black to the ground stake).

Take the dB reading and keep it for reference. If there is a single fault on the cable, it will be approximately the same dB value as the reference reading.

NOTE. To establish how often to take readings on the cable or pipe, move away from the ground stake and take further readings until the arrow has difficulty in locking and the dB reading is low. Measure the distance that the locator is now away from the ground stake. This is the distance that you can safely use between taking readings on the cable or pipe to ensure that you do not miss the fault.

9.3 How to find a fault

Starting from the transmitter, walk along the cable or pipe route pushing the A-Frame spikes into the ground with the green spike pointing away from the transmitter. Where there are no faults the dB reading will be low and the direction arrow may flicker forward and back.

NOTE: Flickering arrows may also indicate that you may be too far away from the fault or ground stake (or both) for the locator to lock on.

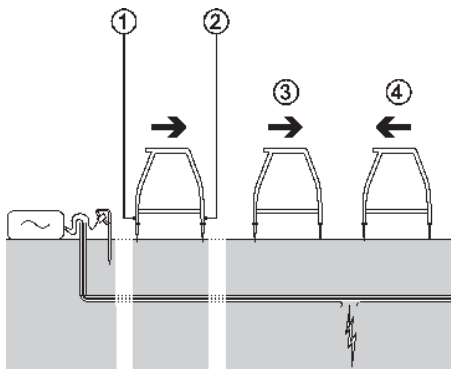

Figure 9.1: Cable sheath fault-finding

If you are trying to locate high resistance faults or there is a long distance between faults, carry on with the survey and the locator will lock on when you get closer to the fault.

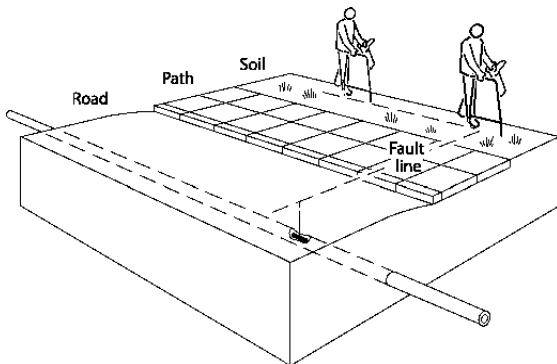



Figure 9.2: Locating faults with the locator and A-frame

Take readings at the survey intervals determined by the reference reading. To locate the cable or pipe while using the fault find signal during a Fault-Find survey, press the  key once and the locator will switch to peak locate mode. To use alternative antenna modes, press the  key to step through available antenna modes. To get back to fault find mode step through all available antenna modes until the locator goes back to fault find mode.

Note: While the A-Frame is connected to the locator, depth and current measurements will not be available. If depth or current measurements are required, remove the A-Frame lead from the locator.

As a fault is approached the Fault-Find direction arrow will lock on to the fault signal, point forward and the dB readings will increase. When the fault is passed the arrow will point back towards the transmitter. Take readings at smaller survey intervals to determine the exact point of the fault.

When the A-frame is directly over the fault the dB reading will drop as shown opposite.

NOTE: The values given are for illustration purposes only and may not be the same as those obtained in other situations.

To pinpoint the fault, turn the A-frame 90° to the cable or pipe and Fault-Find until the exact point is found. Where the arrow direction changes the center line of the A-frame is now directly over the fault.

Mark the ground to show the position of the fault. Find the maximum dB reading in front of the fault by pushing the A-frame into the ground at small intervals. Note the dB reading. If the reading is approximately the same as the reference reading, you can assume that there is only one fault. If the reading is less than the reference reading, keep surveying the cable for other faults.

NOTE: If the cable or pipe runs under a road, use the equipment as normal on the road surface as it can sometimes detect signals when working on blacktop, concrete, or paved surfaces. If necessary, try wetting the road surface. Pouring a very small amount of water around the bottom of the A-frame spikes before each Fault-Find will generally ensure a good ground connection.

NOTE: If the cable or pipe runs under a paved surface, the fault can often be pinpointed by fault finding in the grass / soil adjacent to the paving. Reduce the distance between placing the A-frame spikes in the ground to allow for the increased distance to the actual fault position.

Section 10 - Current direction (CD)

10.1 Understanding CD

Current Direction recognition is a feature that helps to positively identify a line at points distant from the application of the signal. It is highly desirable, if not essential, for positive identification of long distance lines. These lines can be traced and positively identified through congested areas or when running parallel to other lines.

The CD feature on the RD8000PDL and PTL locators indicate the direction of the current flow on a line. Identity of the target line is established if the locator display indicates that the current is flowing forward and away from the point of application of the transmitter signal.

NOTE: CD mode is not supported on the RD8000 PXL.

A signal that has coupled onto adjacent lines finds a return path to the point of the original signal application. This is indicated by the locator arrow pointing back towards the transmitter.

This is in contrast to the forward pointing arrow indicating the target line.

The CD transmitter signal must be directly coupled to the target line and with a remote ground connection. It cannot be applied by normal clamp or induction but can be applied with a transmitter CD clamp.

10.1.1 Using Current Direction (CD) to aid line identification

The RD8000 PDL locator and Tx-10 and Tx-10B transmitters feature several CD frequencies to help you determine the direction of current through a target line.

NOTE: The transmitter and locator must both have the same CD frequency or frequencies installed to enable the feature to be used. If you have more than one CD frequency installed ensure that the transmitter and locator are both set to the same CD frequency.

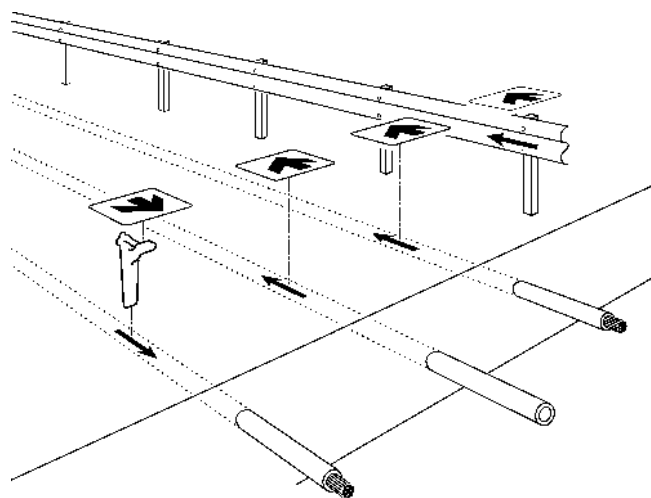



Figure 10.1: Current direction

To select the CD frequency, proceed as follows:

Transmitter

- 1 Switch the transmitter off
- 2 Connect the transmitter to target cable or pipe, either by direct connection or by using a CD clamp
- 3 Switch the transmitter on
- 4 Press the  key until the CD frequency is displayed

CD is a combination of two frequencies, a CD frequency and a locate frequency.

NOTE: RD8000 PTL locator models specific frequencies are only supported by the Tx-10 transmitter model

Locator

- 1 Press the  key until the CD frequency is displayed, indicated by the two small arrows above the frequency value.

10.2 CD Reset

10.2.1 About CD reset

When you trace a signal on very long target lines, the transmitter signal gradually bleeds into the ground by capacitance. This means the phase angle of the remaining signal gradually changes.

This is referred to as phase-shift and can occur whenever an alternating current signal is flowing in a system of conductors that have a significant capacitance or inductance. The relative phase angle between the two frequencies will alter, but only over extended distances.

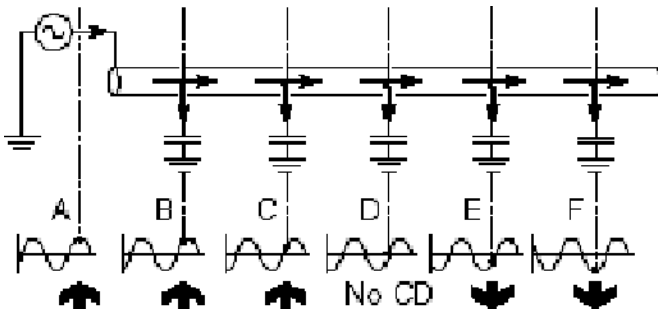

Figure 10.2: CD reset

Figure 13.2 illustrates a buried line with significant capacitance to ground. It illustrates the gradual phase-shift that occurs along the line. The diagram shows a reference point on each waveform. At first, the reference point occurs right on the peak of a positive half cycle (A). It gradually moves towards the zero crossing point (D) and ends up on the peak of a negative half cycle (F). The direction has shifted from forwards to backwards. At the intermediate point (D) the current flow cannot be determined. At this point the CD arrows on the RD8000 locator will flash on and off. In the example shown in the illustration, by returning to (C) which is the last point at which a CD reading was achieved, and performing a CD reset, the response at (C) will be equivalent to that of (A).

In most cases the phase angle shift does not occur until many kilometers from the transmitter and in some cases a CD rest may only be required every 20 kilometers (14 miles).

10.2.2 Using a CD clamp or stethoscope







When using either of these accessories it is important to RESET the CD at a known point, near the transmitter, before making any identification measurements. On both the CD / CM clamp and the CD stethoscope there is an arrow that indicates which way the clamp or stethoscope is facing in relation to the transmitter. If the arrow is pointing away from the transmitter when the CD reset is performed the locator display shows 000 and the bar graph reads 100%. If the arrow is pointing towards the transmitter, the locator display shows 111 and there is no bar graph reading.

Refer to Section 10 for more information on clamps and stethoscopes.

10.2.3 Performing a CD reset

You must perform a CD reset every time you select a CD frequency. CD reset can only be performed when in CD mode.

To perform a CD reset:

- 1 Select any CD frequency using the  key
- 2 Press the  key to enter the menu
- 3 Scroll to the **CDR** menu using the  or  keys
- 4 Press the  key to enter the CDR menu
- 5 Press the  key to reset CD and exit to the main menu

Section 11 - Survey measurements

RD8000 locator models are capable of recording up to 10000 survey measurements to internal memory. When a measurement is taken and saved, the RD8000 locator will store the most relevant measurements taken and information, such as:

- Log number
- Current
- Gain
- Depth
- Signal
- Phase
- Frequency
- Marker type
- GPS location (GPS models only or when paired to GPS compatible devices)

These measurements, taken at specific points indicated by you, can be used to report and map all your findings.

If the locator is a GPS model or if paired to Pocket PC (or **PDA**) with GPS, running a compatible application such as SurveyCERT (see section 11.4) the locator will append position and time information to the data.

NOTE: The internal GPS module needs to be switched on and connected to the GPS satellite system.

Refer to Section 12 -for more information about Bluetooth pairing.

11.1 Saving measurements

To save survey measurements, press the  key.

To achieve accurate results the locator must be kept as still as possible during the saving process.

The locator will always save measurements to internal memory. If Bluetooth is switched on and the Bluetooth survey measurements transmission are active the locator will also attempt to send the saved measurement to a paired PDA running SurveyCERT, see section 4.3, or a compatible application. See chapter 11.2 for instructions on how to enable the Bluetooth transmission to a paired device





If your PDA is out of reach, or if its Bluetooth features are disabled, the locator will display an error code. To avoid these errors disable the Bluetooth survey measurements transmission or ensure that your PDA is within range and correctly paired.

For more information about Bluetooth, please refer to Section 12.

NOTE: A flashing depth and / or current reading display means that the measurement is poor and should be taken again. Poor readings may be caused by nearby conductors or sources of electromagnetic interference.

11.2 Survey measurement transmission over Bluetooth

To configure Bluetooth survey measurements transmissions:





- 1 Press the  key to enter to menu
- 2 Press the  or  keys to select **DATA** menu
- 3 Press the  key to enter the DATA menu
- 4 Scroll up or down to select the **BT-PC** option
- 5 Select **ON** or **OFF**
- 6 Press the  key to make the selection and return to the main menu

11.3 Erasing measurements

The RD8000 locator allows you to delete all measurements. Erasing the survey measurements will wipe the RD8000 Marker memory and is usually recommended when you begin a new survey.

 **WARNING!** Erasing measurements cannot be undone! Proceed with caution!

To erase all stored measurements:

- 1 Press the  key to enter to menu
- 2 Press the  or  keys to select **LOG** menu
- 3 Press the  key to enter the LOG menu
- 4 Scroll up or down to select the **DEL** option
- 5 Press the  key to make the selection and return to the main menu

11.4 SurveyCERT

Stored data can be transferred wirelessly to a compatible PDA running Radiodetection's SurveyCERT app or a PDA compatible application.

The Radiodetection SurveyCERT PDA app can read and chart logged survey data for real-time or post survey analysis. It can also export KML files for interface with GIS / mapping systems.





NOTE: SurveyCERT is compatible with Bluetooth enabled PDAs running Windows Mobile 6.5 as its operating system.

Stored data can also be transferred using the USB connection to the RD Manager software package to be analyzed by the software's built-in Survey measurements capabilities. Refer to the RD Manager operation manual for more info on how to retrieve store survey data.

RD Manager's Survey measurements functionality can be used for post survey analysis, interface to Google Earth® and easy export to GIS / mapping systems.

NOTE: RD Manager is only compatible with PC running Microsoft® Windows® XP or higher.

To send stored data to your paired PDA:

- 1 Ensure your paired PDA is switched on and running the SurveyCERT app
- 2 Press the  key to enter the menu
- 3 Scroll to the **LOG** menu using the  or  keys
- 4 Press the  key to enter the LOG menu
- 5 Scroll up or down to the **SEND** option
- 6 Press the  key and the locator will attempt to send your stored survey data to your PDA

NOTE: When using SurveyCERT the RD8000 marker locator Bluetooth protocol needs to be set to PPP. See Section 12 - for information on how to set the Bluetooth protocol.

To obtain SurveyCERT for PDA:

SurveyCERT for PDAs and its operation manual are available as a free download from the Radiodetection web Site:

- 1 Visit <http://www.radiodetection.com>
- 2 Using the menu bar, go to Support -> SurveyCERT
- 3 Click on the RD8000 SurveyCERT link to get to the SurveyCERT download page and follow the instructions.

To obtain RD Manager:

- 1 Go to www.radiodetection.com/RDManager
- 2 Follow the instructions

Section 12 - Bluetooth wireless connections

RD8000 marker locators feature a Bluetooth wireless module, as standard, providing the ability to connect to compatible devices such as transmitters (Tx-5B or Tx-10B only) or handheld devices running a compatible application.







NOTE: The RD8000 marker locator wireless features maybe subject to national and or local regulations. Please consult your local authorities for more information.

⚠️WARNING! Do not attempt any wireless connection in areas where such technology is considered hazardous. This may include: petrochemical facilities, medical facilities or around navigation equipment.

12.1 Switching Bluetooth On

By default RD8000 marker locators and Bluetooth enabled transmitters are shipped with the Bluetooth wireless connection module disabled.







To switch Bluetooth On:

- 1 Press the  key to enter the menu
- 2 Scroll to the **BT** menu using the  or  keys
- 3 Press the  key (locator) or the  key (transmitter) to enter the BT menu
- 4 Scroll up or down to the **ON** option
- 5 Press the  key to switch Bluetooth ON and return to the previous menu

12.2 Switching Bluetooth off

You can switch Bluetooth off to prolong battery life or comply with regulations in areas where wireless communications are considered hazardous.

To switch Bluetooth off:





- 1 Press the  key to enter the menu
- 2 Scroll to the BT menu using the  or  keys
- 3 Press the  key (locator) or the  key (transmitter) to enter the BT menu
- 4 Scroll up or down to the OFF option
- 5 Press the  key to switch Bluetooth off and return to the previous menu

12.3 Pairing to a transmitter





To pair to a transmitter you require a Bluetooth enabled model such as the Tx-5B or Tx-10B.

Before you begin, you may choose to switch off all nearby Bluetooth equipment as they may interfere with the locator and transmitter's pairing process.



On the locator:

- 1 Press the  key to enter the menu
- 2 Scroll to the **BT** menu using the  or  keys
- 3 Press the  key to enter the BT menu
- 4 Scroll to the **PAIR** menu and press the  key to enter it
- 5 Scroll to the **BT-TX** option

On the transmitter:

- 6 Press the  key to enter the menu
- 7 Scroll to the **BT** menu using the  or  keys
- 8 Press the  key to enter the BT menu
- 9 Scroll to the **PAIR** option

Starting the pairing process:

- 10 Press the  key on the transmitter followed by the  key on the locator. You must press these keys within a 30 second window otherwise the connection may time out
- 11 The transmitter and the locator will now attempt to pair

When pairing is in progress, the transmitter and locator will display a flashing Bluetooth icon. Pairing can take up to a minute. If the pairing process is successful, the transmitter will display the  icon and the locator will display a persistent Bluetooth icon for the duration of the connection.

If pairing fails, ensure that any nearby Bluetooth devices are switched off or invisible then repeat the process.

Once the locator and transmitter have successfully paired you can use iLOC to remotely change the transmitter's output frequency and power levels from the locator. See Section 13.1 for further details.

12.4 Pairing to a PDA

12.4.1 Connection requirements







- Any RD8000 locator
- A compatible Bluetooth enabled PDA

12.4.2 Pairing

Pair the RD8000 locator to your PDA using your PDA's Bluetooth software.

NOTE: The procedure for pairing your PDA may differ depending on the PDA make and model. The following procedure should apply to most PDAs.

On the locator:

- 1 Press the  key to enter the menu
- 2 Scroll to the **BT** menu using the  or  keys
- 3 Press the  key to enter the BT menu
- 4 Scroll up or down to the **PAIR** menu
- 5 Press the  key to enter the PAIR menu
- 6 Scroll up or down to the **BT-PC** option
- 7 Press the  key and the locator will attempt to pair with your PDA





On your PDA:



- 8 From the PDA's **Start menu**, select **Settings** then select the **Connections Tab** followed by the **Bluetooth icon**
- 9 Ensure the Bluetooth radio is switched on and make the PDA visible to other devices
- 10 Select the **Devices tab** and scan for new partnerships
- 11 Create a partnership with the RD8M_xxx device
- 12 If asked for a passkey, enter 1234
- 13 Select the COM Ports tab and make a New Outgoing Port with the RD8000 locator. Note the port number of the selected COM port

12.5 Bluetooth Protocol

RD8000 marker locators can transmit survey measurements to a paired PDA device running a compatible program.

To set the locator to work with Radiodetection's SurveyCERT application, you need to set the data format to the PPP protocol:

- 1 Press the  key to enter the menu
- 2 Scroll to the **BT** menu using the  or  keys
- 3 Press the  key to enter the BT menu

- 4 Scroll up or down to the **PROT** menu
- 5 Press the  key to enter the PROT menu
- 6 Scroll up or down to the **PPP** option
- 7 Press the  key to confirm your choice and exit the menu

Or

Select the **EXIT** option and press the  key to return to the BT submenu.







The ASCII protocol is used when using third party PDA programs. Refer to the software supplier's operation manual for instructions on what setting to select.

12.6 Bluetooth Range

12.6.1 Long Range settings

The RD8000 marker locator is equipped with a Bluetooth module capable of long range transmission. This is used when using the iLOC functionalities.

To set long range transmissions (Class 1) follow these steps:

- 1 Press the  key to enter the menu
- 2 Scroll to the **BT** menu using the  or  keys
- 3 Press the  key to enter the BT menu
- 4 Scroll up or down to the **CLASS** menu
- 5 Press the  key to enter the Class menu
- 6 Scroll up or down to the **1** option
- 7 Press the  key to confirm your choice and exit the menu

Or





Select the **EXIT** option and press the  key to return to the BT submenu.



Using long range Bluetooth transmission is only required when using iLOC and its use when paired to a PDA will result in a reduced battery life.

NOTE: Use of a Class 1 Bluetooth may be prohibited in certain areas or countries.

12.6.2 Standard Range settings

If using the locator with a PDA only, you should set the transmission class to standard range (Class 2).

- 8 Press the  key to enter the menu
- 9 Scroll to the **BT** menu using the  or  keys
- 10 Press the  key to enter the BT menu

- 11 Scroll up or down to the **CLASS** menu
- 12 Press the  key to enter the Class menu
- 13 Scroll up or down to the **2** option
- 14 Press the  key to confirm your choice and exit the menu





Or

Select the **EXIT** option and press the  key to return to the BT submenu.





12.7 Bluetooth Connection mode

When using the Bluetooth connection on the RD8000, the Bluetooth module is by default kept in standby mode. This can help to increase the locator battery life and in some applications reduce potential interference from the Bluetooth module.

The RD8000 marker locator provides users with the option to set the Bluetooth module to STANDBY or ON. In the ON position the Bluetooth module will be permanently ready to send data, which can help to speed up the transfer times compared to that of modules set to STANDBY mode. To select Bluetooth to STDBY :

- 1 Press the  key to enter the menu
- 2 Scroll to the **BT** menu using the  or  keys
- 3 Press the  key to enter the BT menu
- 4 Scroll up or down to the **STDBY** menu
- 5 Press the  key to confirm your choice

To set Bluetooth connection mode to ON:

- 1 Press the  key to enter the menu
- 2 Scroll to the **BT** menu using the  or  keys
- 3 Press the  key to enter the BT menu
- 4 Scroll up or down to the **ON** option
- 5 Press the  key to confirm your choice

12.8 Troubleshooting

Successful wireless communication depends on a number of factors including: battery life, electromagnetic interference, device memory and physical obstructions.

Ensure that the RD8000 transmitter, locator and any other wireless device is sufficiently charged for wireless communication. Note that many PDAs will suspend wireless connections when their battery capacity drops below a threshold percentage. Consult your device's documentation for more information.

Excessive electromagnetic interference can effectively limit the range of wireless communication and / or corrupt data.





Your PDA device may have insufficient memory to maintain a wireless link, particularly if the connection is sustained over an hour or longer. Make sure you quit applications on your PDA using the method described in your device's documentation.

Although iLOC can successfully function at distances up to 300m (1000ft) in direct line of sight, your PDA (or notebook) and the RD8000 locator must be within 10m (30ft) to maintain a wireless connection.

12.8.1 Resetting connections

If you experience problems with the RD8000 wireless Bluetooth technology features, Radiodetection recommends resetting the connection and then pairing your device again.

To reset the wireless connections:

- 6 Press the  key to enter the menu
- 7 Scroll to the **BT** menu using the  or  keys
- 8 Press the  key to enter the BT menu
- 9 Scroll up or down to the **RESET** menu
- 10 Press the  key and the locator will purge all current connections
- 11 Re-pair your devices as described in section 4.4

12.8.2 Bluetooth error codes

If an error occurs when attempting to perform any Bluetooth command using the locator to the transmitter or the locator to a PDA, the LCD will display a code to help you resolve the problem on the locator.

The codes are as follows:

Table 4.1: Bluetooth error codes

BT Code	Description
BT001	Bluetooth not configured for this unit
BT002	Internal Bluetooth error
BT003	Locator not paired with transmitter
BT004	Locator not paired with PDA
BT005	Paired but connection attempt failed. Power cycling may be required
BT006	Corrupt response received from transmitter
BT007	Indeterminate response received from transmitter
BT008	No response received from transmitter
BT009	Corrupt response received from PDA
BT010	Transmission to PDA failure
TX???	Transmitter unable to change to the requested frequency

Section 13 - iLOC

iLOC is a standard feature of all RD8000 Marker locator models. iLOC lets you control a Bluetooth transmitter (Tx-5B or Tx-10B models) remotely using your RD8000 locator. With iLOC you can adjust the output frequency, power settings and use *SideStep*. iLOC commands are sent over a Bluetooth module that can operate at distances of up to 300m / 1000ft in direct line of sight.

To use iLOC, the transmitter and locator must be paired using the procedure described in Section 5.3.

NOTE: Operating in built up areas and in areas with high electromagnetic interference may reduce iLOC's performance.

13.1 Using iLOC

Locator and transmitter need to be switched ON and paired to use iLOC.



For optimum performance:

- Face the back end of the transmitter towards the locator as this is where the Bluetooth module is fitted
- If possible, raise the transmitter off the ground by 30-60cm (1-2ft)
- Try to avoid obstructions in line of sight

NOTE: If any iLOC commands fail, move closer to the transmitter and repeat the process.

13.1.1 Changing frequencies

Once the transmitter and the locator are paired, you can change the transmitter's output frequency remotely using the locator:





- 1 On the locator, select the frequency you want by pressing the  key until the frequency is displayed on screen.
- 2 iLOC commands are sent using the  key, press it to send the new frequency to the transmitter.
- 3 The locator's LCD will display **SEND** momentarily and then **OK** if the transfer is successful.
- 4 If the transfer is unsuccessful, the LCD will display an error code. Refer to Section 4.6.3 for a list of codes and their meaning.

If the process fails, you may be out of range or there may be an error in the connection. Move closer to the transmitter and retry the procedure. If the connection continues to fail, return to the transmitter and reset the connection using the procedure described in Section 4.6.1.

13.1.2 Adjusting power

iLOC lets you adjust the transmitter's power output remotely; you can also put the transmitter into standby mode and then wake it remotely, see section 5.3.3 for more details.

To adjust the power output:

- 1 Transmitter power options are located in the **TXOUT** menu on the locator. Press and hold the  key to display the TXOUT menu
- 2 Press the  key to enter the TXOUT menu
- 3 Scroll up or down through the power output options; these are:
 - **STDBY:** Transmitter standby mode, the connection is still active but the output is disabled
 - **LOW:** Low power output
 - **MED:** Medium power output
 - **HIGH:** High power output
 - **BOOST:** Temporarily boosts transmitter power output to its maximum level
- 4 Once you have selected the mode you want, press the  key to confirm
- 5 Press and hold the  key to select the new setting and exit the menu
- 6 Press the  key once to send the settings to the transmitter

NOTE: Once you have stored the transmitter power setting in the locator, the locator will change the transmitter to that setting when you change the frequency with the locator.

13.1.3 Sleep / wake the transmitter

To help you prolong battery life you can put the transmitter in standby mode (sleep), and reactivate it again, using the locator.

To put the transmitter into standby mode, set the TXOUT menu on the locator to **STDBY** using the "Changing transmitter power output" procedure described above in section 13.1.2.

This will disable the transmitter output.

To re-activate the transmitter output, select any power mode from LOW to BOOST using the same procedure.



If the process fails, you may be out of range or there may be an error in the connection. Move closer to the transmitter and retry the procedure. If the connection

continues to fail, return to the transmitter and reset the connection using the procedure described in Section 5.5.1.

13.1.4 SideStep

If you are using a preferred locate frequency and having difficulty locating the utility, interference could be affecting the locate signal. SideStep allows the locator to change the locate frequency by several Hertz. This 'new' locate frequency can be sent via the Bluetooth connection to the transmitter and will automatically change the transmitter frequency to match the 'new' locate frequency.

To step the frequency:

- 1 On the locator, select the frequency you want by pressing the  key until the frequency is displayed on screen
- 2 To step the frequency, press and hold the  key until **STEP** appears on the LCD
- 3 Press the  key to send the SideStep command to the transmitter
- 4 If the command is sent successfully, an asterisk (*) will appear on the locator next to the frequency and STEP will appear on the transmitter below the frequency
- 5 Repeat this process to disable SideStep

Section 14 - Appendices

14.1 Care and maintenance

The RD8000 locator and transmitter are robust, durable and weatherproof. However you can extend your equipment's life by following these care and maintenance guidelines.

14.1.1 General

Store the equipment in a clean and dry environment.

Ensure all terminals and connection sockets are clean, free of debris and corrosion and are undamaged.

Do not use this equipment when damaged or faulty.

14.1.2 Batteries and power supply

Use good quality Alkaline or NiMH batteries only.

When using an AC adapter, use only Radiodetection approved adapters.

Only use Radiodetection approved Li-ion battery packs.

14.1.3 Cleaning

 **WARNING!** Do not attempt to clean this equipment when it is powered or connected to any power source, including batteries, adapters and live cables.

Ensure the equipment is clean and dry whenever possible.

Clean this equipment with soft, moistened cloth.

If using this equipment in foul water systems or other areas where biological hazards may be present, use an appropriate disinfectant.

Do not use abrasive materials or chemicals as they may damage the casing, including the reflective labels.

Do not use high pressure hoses.

14.1.4 Disassembly

Do not attempt to disassemble this equipment under any circumstances. The locator and transmitter contain no user serviceable parts.

Disassembly may damage the equipment and or reduce its performance and may void the manufacturer's warranty.

14.1.5 Service and maintenance

The locator and transmitter are designed to minimize the requirement for regular calibration. However, as with all safety equipment, it is recommended (and may be required by law) that they are serviced at least once a

year, either at Radiodetection or a Radiodetection-approved repair center.

Regularly check your equipment using eCert. This automatic validation test ensures the equipment is valid according to its original factory calibration, see 14.5.

NOTE: Service by non-approved service centers or operators may void the manufacturer's warranty.

Radiodetection products, including this guide, are under continuous development and are subject to change without notice. Go to www.radiodetection.com or contact your local Radiodetection representative for the latest information regarding the RD8000 marker locator or any Radiodetection product.

14.2 Time and Date error messages

RD8000 logging and GPS models feature an internal clock which is used to time and date survey measurements, the 1x second internal logging and for the CALSafe feature.

Every time the locator is switched on, it performs a check to verify its correct operation.

In the unlikely event of an issue with this clock the system will report an error message:

The unit will emit a warning audio tone and display the word **ERROR**, followed by a 3 digit error code.

Please make a note of this code and contact your nearest service center.

14.3 Warranty and extended warranty

RD8000 Marker locators and transmitters are covered by a 1 year warranty as standard.

Customers can extend the warranty period to a total of 3 years by registering their products (locators and transmitters) within 3 months from purchase.

Registration is done using the RD Manager PC software. See section 14.3.

From time to time Radiodetection may release new software to improve the performance or add new functionalities to his products. By registering user will benefit from subscribing to e-mail alerts advising about any new software and special offers related to its product range.

Users will be able to opt out at any moment from receiving software and technical notifications or just from receiving marketing material.

14.3.1 Registering using e-mail

If you have problem in obtaining and installing the RD Manager software you can also register your product(s) by sending an e-mail to rd-support@spx.com.

You will need to provide the following compulsory details:

- 1 Date of Purchase
- 2 Serial Number of each of your qualifying products (RD8000 locators and transmitters)
- 3 Your e-mail address
- 4 Your Company name
- 5 Contact Name
- 6 Address
- 7 Telephone Number
- 8 Country of residence
- 9 Indicate if you do not wish to receive e-mail alerts advising about any new software release (OPT OUT)
- 10 Indicate if you do wish to receive e-mail or other marketing material with new product information or special offers and promotions related to its product range (OPT IN)

14.4 RD Manager™

RD Manager is the RD8000 Marker Locator PC companion and it allows you to manage and customize your locator. It also allows software upgrades to both the locator and transmitter.

You can use RD Manager to register your products to extend the warranty by 2 years (see section 14.2), setup your locator by performing a number of maintenance tasks, such as setting date and time, activating and deactivating active frequencies or RF markers, or setting-up functions like CALSafe or StrikeAlert.

RD Manager is also used to retrieve and analyze surveys data and internal logged data (logging and GPS models only).

RD Manager is compatible PCs running with Microsoft Windows XP, Vista, Windows 7 and Windows 8.

For more information about RD Manager refer to its operation manual.

To Obtain RD Manager:

- 3 Go to www.radiodetection.com/RDManager
- 4 Follow the instructions

14.5 Upgrading software

From time to time, Radiodetection may release software upgrades to enhance features and improve performance of the RD8000 locator or transmitter.

Software upgrades are free of charge.

You can check if your products are up-to-date or upgrade them by using the RD Manager software upgrade screen. Refer to its operation manual for further information.

E-mail alerts and notification of new software releases are sent to all registered users.

NOTE: To upgrade your software you need to have created an account using RD Manager and have a live internet connection. An optional Radiodetection supplied power source may be required to update your transmitter software.

14.6 eCert

The RD8000 marker locator should be regularly checked to ensure its correct operation.

eCert provides a thorough test of the RD8000's locating circuitry and marker transceiver, and supplies a Radiodetection Calibration Certificate when a positive test result is obtained.

To run eCert, the locator should be connected to an internet-enabled PC, on which the RD Manager software is installed. Additional eCert credits may be required and purchased.

Refer to the RD Manager operation manual for further details.

NOTE: eCert is not presently available for transmitters.

14.7 System Specifications

Features are model dependent

Sensitivity	5 μ A at 1 meter (33kHz)
Dynamic range	140dB rms/ \sqrt Hz
Selectivity	120dB/Hz
Maximum depth ⁽¹⁾	Line: 20' / 6m Sonde: 50' / 15m RF Markers: Near Surface: 2' / 60cm Ball Marker: 4.9' / 1.5m Mid-Range: 5.9' / 1.8m Full Range: 7.9' / 2.4m
Depth accuracy ⁽²⁾	Line: \pm 5% tolerance 4" / 0.1m to 10' / 3m Sonde: \pm 5% tolerance 4" / 0.1m to 23' / 7m RF Markers: \pm 15% \pm 2" / 5cm up to the maximum depth
Locate accuracy ⁽¹⁾	\pm 5% of depth
Horizontal GPS Position Accuracy	3m CEP (Circular Error Probable)
CD Fault-Finding (CDFF)	Up to 13 CD pairs, 220Hz to 1248Hz
Fault-Finding (FF)	Diagnose cable sheath faults from short circuit to 2M Ω using the A-frame
Max Transmitter Power output	1W (Tx-1), 5W (Tx-5 and Tx-5B), 10W (Tx-10 and Tx-10B)
Dynamic overload protection	30dB (automatic)
Batteries	Locator: Li-Ion battery pack or 3 x D-cells (LR20) Transmitter: 8 x D-cells (LR20) or optional Li-Ion battery pack
Battery Life (continuous usage) ⁽³⁾	Locator: Li-Ion or Alkaline up to 25 hours Transmitter: Alkaline up to 23 hours
Warranty	12 Month standard, 36 Months upon registration
Compliance	FCC, RSS 310, RoHS, WEEE, CE, Bluetooth
Approvals	CE, Bluetooth
Weight	Locator: 4.6lbs / 2.1kg (including Li-Ion battery pack) Transmitter: 6.2lbs / 2.8kg (including alkaline batteries) 9.3lbs / 4.2kg (including accessories)
Dimension (H x D x W)	Locator: 25.5" x 11.3" x 7" / 648 x 286 x 177mm Transmitter: 14" x 8.9" x 8.1" / 356 x 227 x 207mm
Construction	Injection Molded ABS Plastic
Ingress Protection	IP54
Operating Temperature Storage Temperature ⁽⁴⁾	-4 to 122°F / -10 to 50°C -4 to 158°F / -20 to 70°C

(1) In Good Conditions.

(2) RD8000 will locate to greater depths, but accuracy may be reduced.

(3) At 70°F / 21°C with good quality batteries, transmitter output set to 1W.

(4) The Li-Ion battery packs can only be stored in temperatures up to 95°F / 35°C. If using alkaline or NiMH batteries check the manufacturer's datasheet for their recommended storage and operating temperature limits.

14.8 Supported frequencies

14.8.1 Sonde Frequencies

All RD8000 locators support the following sonde frequencies: 512Hz, 640Hz, 8192Hz (8kHz), 32768Hz (33kHz).

14.8.2 Passive Frequencies

Frequency	RD8KPXLM	RD8KPDLM	RD8KPTLM	RD8KPTLM 1-3	RD8KPTLM 4-6
Power	✓	✓	✓	✓	✓
Radio	✓	✓	✓	✓	✓
CATV (31250 / 31468Hz)		✓	✓	✓	✓
CPS (100 / 120Hz)		✓	✓	✓	✓
Passive Avoidance Mode		✓	✓	✓	✓

14.8.3 CD Frequency Pairs

CD / LF Frequency Pair / Active Frequency	RD8KPXLM	RD8KPDLM	RD8KPTLM	RD8KPTLM 1-3	RD8KPTLM 4-6
219.9Hz / 439.8Hz			✓		✓
256Hz / 512Hz		✓	✓	✓	✓
280Hz / 560Hz			✓	✓	
285Hz / 570Hz		✓	✓	✓	✓
320Hz / 640Hz		✓	✓	✓	✓
380Hz / 760Hz		✓	✓	✓	✓
460Hz / 920Hz		✓			
680Hz / 340Hz (INV)			✓	✓	
800Hz / 400Hz (INV)			✓	✓	
920Hz / 460Hz (INV)			✓	✓	✓
968Hz / 484Hz (INV)			✓	✓	
1168Hz / 584 Hz (INV)			✓	✓	
1248 Hz / 624 Hz (INV)			✓	✓	

14.8.4 Active Frequencies

Frequency	RD8KPXLM	RD8KPDLM	RD8KPTLM	RD8KPTLM 1-3	RD8KPTLM 4-6
ELF (98 / 128Hz)		✓	✓	✓	✓
163Hz			✓		✓
208Hz			✓		✓
273Hz			✓	✓	
340Hz			✓	✓	
400Hz			✓	✓	
439.8Hz			✓		✓
459.9Hz			✓	✓	✓
480Hz			✓	✓	✓
484Hz			✓	✓	
491Hz			✓	✓	✓
512Hz	✓	✓	✓	✓	✓
560Hz			✓	✓	
570Hz		✓	✓	✓	✓
577Hz	✓	✓	✓	✓	✓
584Hz			✓	✓	
624Hz			✓	✓	
640Hz	✓	✓	✓	✓	✓
760Hz		✓	✓	✓	✓
815Hz			✓	✓	✓
870Hz	✓	✓	✓	✓	✓
920Hz		✓			
940Hz	✓	✓	✓	✓	✓
982Hz			✓	✓	✓
1090Hz			✓	✓	✓
1450Hz			✓	✓	✓
4096Hz			✓	✓	✓
8kHz (8192Hz)	✓	✓	✓	✓	✓
8440Hz			✓	✓	✓
9.8kHz (9820Hz)		✓	✓	✓	✓
33kHz (32768Hz)	✓	✓	✓	✓	✓
65kHz (65536Hz)	✓	✓	✓	✓	✓
82000Hz			✓	✓	✓
83kHz (83077Hz)	✓	✓	✓	✓	✓
131kHz (131072Hz)	✓	✓	✓	✓	✓
200kHz (200000Hz)	✓	✓	✓	✓	✓

14.9 RF Markers

The RD8000 Marker is compatible with any RF marker tuned to the frequency shown in the table below:

Utility	Color	Frequency
French Power	Natural	40.0kHz
General / Non-drinkable water	Purple	66.35kHz
Cable TV	Black / Orange	77.0kHz
Gas	Yellow	83.0kHz
Telephone / Telecoms	Orange	101.4kHz
Sanitary	Green	121.6kHz
German Power	Blue / Red	134.0kHz
Water	Blue	145.7kHz
Electrical Power*	Red	169.8kHz

*Use of the red Electrical Power (PWR) marker locate mode is subject to radio licensing restrictions for Short Range Devices in the EU and possibly other countries. It is the responsibility of the user to ensure that the red Power (PWR) marker locate mode is only enabled in countries where radio licensing restrictions do not apply at the operating frequency of 169 kHz.

14.10 Supported accessories

Description	Part Number
Transmitter Accessories	
UK plug connector	10/AC1231-4KTX-LPC-UK
European plug connector	10/AC1231-4KTX-LPC-EUR
Live cable connector	10/AC1231-4KTX-LCC
2" (50mm) Transmitter Clamp	10/TC2136-4KTX
4" (100mm) Transmitter Clamp	10/TC1769-4KTX
8.5" (215mm) Transmitter Clamp	10/RD7GT0235
Current direction transmitter clamp	10/TC2651-4KTX
Signal clamp extension rod	10/EXT
Mains power AC transformer to 12V DC	10/RD7K8KUMPSU
12V Car Power Lead (with Isolation Transformer)	10/RD7K8KDCIS
Tx direct connection lead	17/TX2609E1
High Strength Magnet with M4 eyebolt	26/F4ME16M4
Earth reel	09/310-4KTX
Earth stake	04/PT1505N27
Short earth stake	04/ET2980P8
Transmitter connection kit	10/TX-KIT
Tx121, Core to core fault isolation transformer, German	10/TX121-DE
Tx121, Core to core fault isolation transformer, English	10/TX121-EN
Tx121, Core to core fault isolation transformer, French	10/TX121-FR
Tx121, Core to core fault isolation transformer, Dutch	10/TX121-NL

Description	Part Number
Locator accessories	
High gain stethoscope	10/AC2645-4KRX
Small stethoscope	10/AC2643-4KRX
Large stethoscope	10/AC2644-4KRX
640/512Hz submersible DD antenna (10m cable)	10/SM1099-640-4KRX
8kHz submersible DD antenna (10m cable)	10/SM1099-8-4KRX
Additional submersible cable length (per meter)	10/RD0246SUBCABL
Headphones	04/LP01
A-frame	10/AFRAME-4K7K8K
A-frame Bag	10/RD4FFRXBAG
50mm (2") locator clamp	10/TC2136-4KRX
100mm (4") locator clamp	10/TC1769-4KRX
50mm (2") locator Current Direction (CD) clamp	10/CM2054-4KRX
Signal clamp extension rod	10/EXT
Soft carry bag	10/LOCATORBAG
Hard case	10/RD7K8KCASE

Description	Part Number
Sondes and sonde accessories	
Standard Sonde 33kHz depth 5m	10/SC0412-33R
Sewer Sonde 33kHz depth 8m	10/SA0337-33R
Super Sonde 33kHz depth 15m	10/SB0338-33R
Slim Sonde 33kHz depth 3.5m	10/SD0322-33R
Slim sonde plain end cap	10/SD0223
Slim sonde blank end cap	10/SD0268
S18A Small Sonde 33kHz, DL1/3N battery, short	10/S18/82-33-000
S18B Small Sonde 33kHz, AA battery, extended	10/S18/173-33-000
Standard Sonde 8kHz	10/SCO412-8
Standard Sonde 512Hz	10/SCO412-512
Spring coupling m10 male	10/SU0335
S13 ½" / 12.7mm Sonde Kit	10/S13-33-KIT
S9 - 9mm Sonde Kit	10/S9-33-KIT
S6 - 6mm Sonde Kit	10/S6-33-KIT
Flexrod coupler (joins two Flexrods together)	02/FR0818N1
Flexrod blank for machinery	02/FR0336
115mm (4.5") diameter floats/pair	10/SU0344
M10 thread protecting nipple	02/SA0353A
External shell for heavy-duty applications	10/SC0963
Plastic or cane rod connector, male	02/SU0339
GD rod connector. 3/4" (19mm) x 12 BSF, female	02/SU0340
Wards rod connector, 3/4" (19mm) x 10 BSW,	02/SU0341
Wards rod connector, 1/2" (13mm) x 12 BSW,	02/SU0342
Lockfast connector, 3/4" (19mm) x 10 BSW	02/SU0676
Spring coupling M10 male	10/SU0335
FlexiTrace 50m	10/TRACE50 -GB -F -D -NL
FlexiTrace 80m	10/TRACE80 -GB -F -D
9mm 120m Flexrod	10/FLEXRODF120
9mm 60m Flexrod	10/FLEXRODF60

Description	Part Number
Batteries and rechargeable	
D-Cell Alkaline Battery (LR20, MN1300)	04/MN1300
Transmitter Li-ion rechargeable battery pack	10/TXRBATPACK
Transmitter Li-ion rechargeable battery pack (Inc. mains, 12V chargers and lead) (US cordset)	10/TXRBATPACKKIT-US
Transmitter Li-ion rechargeable battery pack (Inc. mains, 12V chargers and lead) (UK cordset)	10/TXRBATPACKKIT-UK
Transmitter Li-ion rechargeable battery pack (Inc. mains, 12V chargers and lead) (EU cordset)	10/TXRBATPACKKIT-EU
Transmitter Li-ion rechargeable battery pack (Inc. mains charger and lead, US cordset)	10/TXRBATPACK-MC-US
Transmitter Li-ion rechargeable battery pack (Inc. mains charger and lead, UK cordset)	10/TXRBATPACK-MC-UK
Transmitter Li-ion rechargeable battery pack (Inc. mains charger and lead, EU cordset)	10/TXRBATPACK-MC-EU
Transmitter Li-ion rechargeable battery pack automotive charger	10/TX-AUTOCHARGER
Transmitter Li-ion rechargeable battery pack mains charger (EU cordset)	10/TX-MAINSCHARGER-EU
Transmitter Li-ion rechargeable battery pack mains charger (UK cordset)	10/TX-MAINSCHARGER-UK
Transmitter Li-ion rechargeable battery pack mains charger (US cordset)	10/TX-MAINSCHARGER-US
Replacement spare Li-ion rechargeable battery pack	10/RX-BATPACK-LI-ION
Locator Li-ion mains charger (EU cordset)	10/LI-ION-MAINSCHARGER-EU
Locator Li-ion mains charger (UK cordset)	10/LI-ION-MAINSCHARGER-UK
Locator Li-ion mains charger (US cordset)	10/LI-ION-MAINSCHARGER-US
Locator automotive charger	10/RX-LI-ION-AUTOCHARGER
Locator replacement alkaline battery adapter – 3x D-Cell tray	10/RX-3DCELL-TRAY
Calibration credits	
eCert calibration credit	10/RD-ECERT

RD8000

**RADIODETECTION'S UNIVERSAL
PRECISION CABLE, PIPE AND RF
MARKER LOCATOR**



Global locations

USA

SPX Global Headquarters

13515 Ballantyne Corporate Place
Charlotte, NC 28277, USA
Tel: +1 704 752 4400
www.spx.com

Radiodetection

28 Tower Road, Raymond, Maine 04071, USA
Tel: +1 (207) 655 8525
Toll Free: +1 (877) 247 3797
Fax: +1 (207) 655 8535
rd.sales.us@spx.com
www.radiodetection.com

Pearpoint

39-740 Garand Lane, Unit B
Palm Desert, CA 92211, USA
Tel: +1 800 688 8094
Tel: +1 760 343 7350
Fax: +1 760 343 7351
pearpoint.sales.us@spx.com
www.radiodetection.com

Radiodetection (Canada)

344 Edgeley Boulevard, Unit 34
Concord, Ontario L4K 4B7, Canada
Tel: +1 (905) 660 9995
Toll Free: +1 (800) 665 7953
Fax: +1 (905) 660 9579
rd.sales.ca@spx.com
www.radiodetection.com

EUROPE

Radiodetection Ltd. (UK)

Western Drive, Bristol BS14 0AF, UK
Tel: +44 (0) 117 976 7776
Fax: +44 (0) 117 976 7775
rd.sales.uk@spx.com
www.radiodetection.com

Radiodetection (France)

13 Grande Rue, 76220, Neuf Marché, France
Tel: +33 (0) 2 32 89 93 60
Fax: +33 (0) 2 35 90 95 58
rd.sales.fr@spx.com
<http://fr.radiodetection.com>

Radiodetection (Benelux)

Industriestraat 11
7041 GD 's-Heerenberg, Netherlands
Tel: +31 (0) 314 66 47 00
Fax: +31 (0) 314 66 41 30
rd.sales.nl@spx.com
<http://nl.radiodetection.com>

Radiodetection (Germany)

Groendahlscher Weg 118
46446 Emmerich am Rhein, Germany
Tel: +49 (0) 28 51 92 37 20
Fax: +49 (0) 28 51 92 37 520
rd.sales.de@spx.com
<http://de.radiodetection.com>

ASIA-PACIFIC

Radiodetection (Asia-Pacific)

Room 708, CC Wu Building
302-308 Hennessy Road, Wan Chai
Hong Kong SAR, China
Tel: +852 2110 8160
Fax: +852 2110 9681
rd.sales.asiapacific@spx.com
www.radiodetection.com

Radiodetection (China)

Room 5-10, Workshop 4
No. 10 Zhenggezhuang Village
Beiqijia Town, Changping District
Beijing 102209, China
Tel: +86 (0) 10 8178 5652
Fax: +86 (0) 10 8178 5662
rd.service.cn@spx.com
<http://cn.radiodetection.com>

Radiodetection (Australia)

Unit H11, 101 Rookwood Road,
Yagoona NSW 2199, Australia
Tel: +61 (0) 2 9707 3222
Fax: +61 (0) 2 9707 3788
rd.sales.au@spx.com
www.radiodetection.com

Radiodetection is a leading global developer and supplier of test equipment used by utility companies to help install, protect and maintain their infrastructure networks. Radiodetection is a unit of SPX (NYSE: SPW), a global Fortune 500 multi-industry manufacturing company. With headquarters in Charlotte, N.C., SPX has 14,000 employees in more than 35 countries worldwide. Visit www.spx.com.