

Smart Evaporator C1

Instruction Manual

Please read this instruction manual before use.
Follow the basic procedure as shown.



Chapter 1) Introduction / P 2

Smart Evaporator has two features below:

- Can be used for evaporating volatile solvents.
- Can be used for keeping a temperature.

This instruction manual explains product summary, operation, trouble processing, maintenance and storage below;

- Must read this instruction manual before use.
- Must understand the '**Warning**' and the '**Caution**' in this manual before use.
- Adhere to the instruction manual.
- Keep the machine out of the reach of children.
- All rights are reserved.
- If the instruction manual has mistakes or anything unpleasant, please ask local distributors.
- Please note that the product specification is subjected to the alternation without any notice.
- The instruction manual has some pictures which are pumps, containers and traps.
However, please notice that these systems are not included in the product.
- Don't use cold trap with "liquid nitrogen" because it could cause explosion due to the liquefaction of oxygen in air.
- Please notice that a vacuum pump is not included in the product.

Chapters

Chapter 1) Introduction / P 2

Chapter 2) To use safely / P 4~6

Chapter 3) Part names / P 7~8

3-1 Front side / P 7

3-2 Back side / P 8

Chapter 4) Before use / P 9~10

Chapter 5) How to use / P 11~29

5-1 Simple system connection P 12~15

5-2 Simple system connection 【Replacing gas】 P 16~18

5-3 Closed circulation system P 19~23

5-4 Closed circulation system 【Replacing gas】 P 24~29

Chapter 6) Troubleshooting / P 30

Chapter 7) Question and Answer / P 31



Chapter 8) Limited Warranty / P 32

Chapter 9) Product Specifications / P 33

Chapter 2) To use safely / P 4~6

2-1 Important safety instructions

There are two messages below;

 Warning	May result in death and serious injury
 Caution	May result in minor injury and property damage

 Warning	<ul style="list-style-type: none">▪ Use for volatile solvents only.▪ Please protect the machine from water, inflammable gas and explosive gas. Insufficient protection may result in a fire, malfunctioning or break down.▪ Don't expose the unit to avoid shock hazard.▪ Please follow safety instructions during use.▪ If you use the Smart Evaporator for in different ways other than instruction in this manual, we are not liable for any damages arising.
---	--



2-2 Setting up the machine

 Warning	<ul style="list-style-type: none">• Don't use the Smart Evaporator outside laboratory.• Avoid watery area or water splash.• Avoid tilt, vibration and shock.• Keep the machine and the power cord away from heat.• Connect the power cord properly.• Don't place something on power cord to avoid accidents.• Don't use multiple-tap electricity with the Smart Evaporator.
 Caution	<ul style="list-style-type: none">• Place the machine horizontally.• Keep enough space around the Smart Evaporator to avoid heat accumulation.• Don't place objects on the Smart Evaporator.

Power source

You can use the machine in countries / regions where the power supply is on 120V AC.

2-3 Before use

 Warning	<ul style="list-style-type: none">• Must confirm a normal running for electric switch and temperature control before use.• Must connect with the power cord to the outlet properly.
 Caution	<ul style="list-style-type: none">• If you find out any trouble or damage, don't use the Smart Evaporator. <p>Example</p> <ul style="list-style-type: none">• The power cord and outlet have damages.• The Smart Evaporator has damages.• The temperature control panel has damages.

2-4 While in use

 Caution	<ul style="list-style-type: none">• Avoid tilt, vibration and shock during running.• Avoid sucking solvents and trashes directly.• Don't put solvents, trash, water, etc into ports of the Smart Evaporator.
---	--

2-5 Storage

 Warning	<ul style="list-style-type: none">• Keep temperature from 10 to 40 °C. (Avoid direct sunlight)• Keep humidity from 20 % to 70 % (Not condensation)• Avoid conditions below; Explosive gas, flammable gas and Corrosive gas, Chemical and Water Tilt, Vibration and Shock Dust, Iron powder and Oily smoke Environment may cause adverse effect for the electric circuit Severe temperature changes
---	--

2-6 Maintenance

 Warning	<ul style="list-style-type: none">• Don't expose the unit to avoid shock hazard.• Don't do anything to the unit for the maintenance except the description in this manual.• If the Smart Evaporator need repair, please ask your distributor immediately.• In case of spilling water or solvents, please clean it off after turning off the power immediately.
---	---

2-7 Disclaimer

The company is not liable for any damages arising from earthquakes, lightning, storms, floods or other natural disasters, as well as fires, actions by third parties, other accidents, intentional or mistaken operation by the customer, or use under other unusual conditions outside the responsibility of the company.

The company is not liable for any damages (loss of business income, disruption of business and etc.) arising from use of or inability to use the product.

The company is not liable for any damages from using in different ways other than instruction in this manual.

Chapter 3) Part names / P 7~8

3-1 Front side

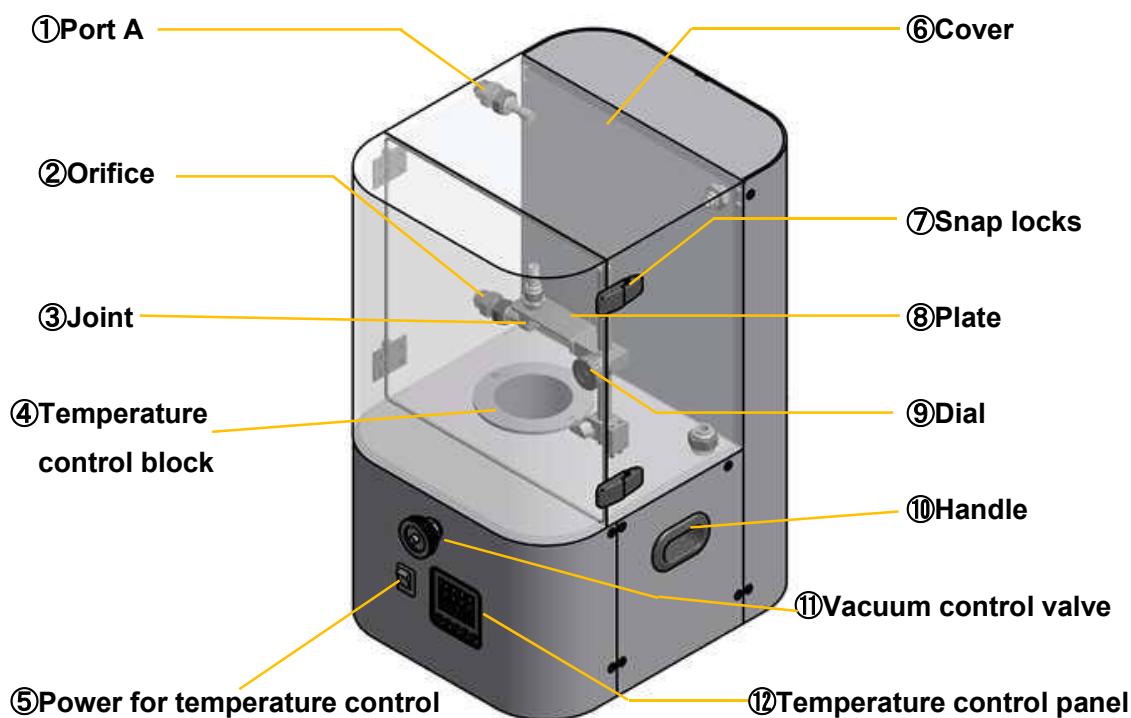

Part name	Function
① Port A	In case of the replacing gas, connect the gas tube
② Orifice	In case of the replacing gas, leak gas
③ Joint	To connect the plug
④ Temperature control block	To regulate the temperature *Please put aluminum beads in before use
⑤ Power for temperature control	To supply electricity to temperature control block To turn the temperature unit on/off
⑥ Cover	For replacing gas
⑦ Snap lock	To seal replaced gas inside
⑧ Plate	To set a plug to the container
⑨ Dial	To adjust the height of the plate
⑩ Handle	Used to carry the machine
⑪ Vacuum control valve	To adjust gas influx
⑫ Temperature control panel	To set temperature from room temperature to 100°C

3-2 Back side

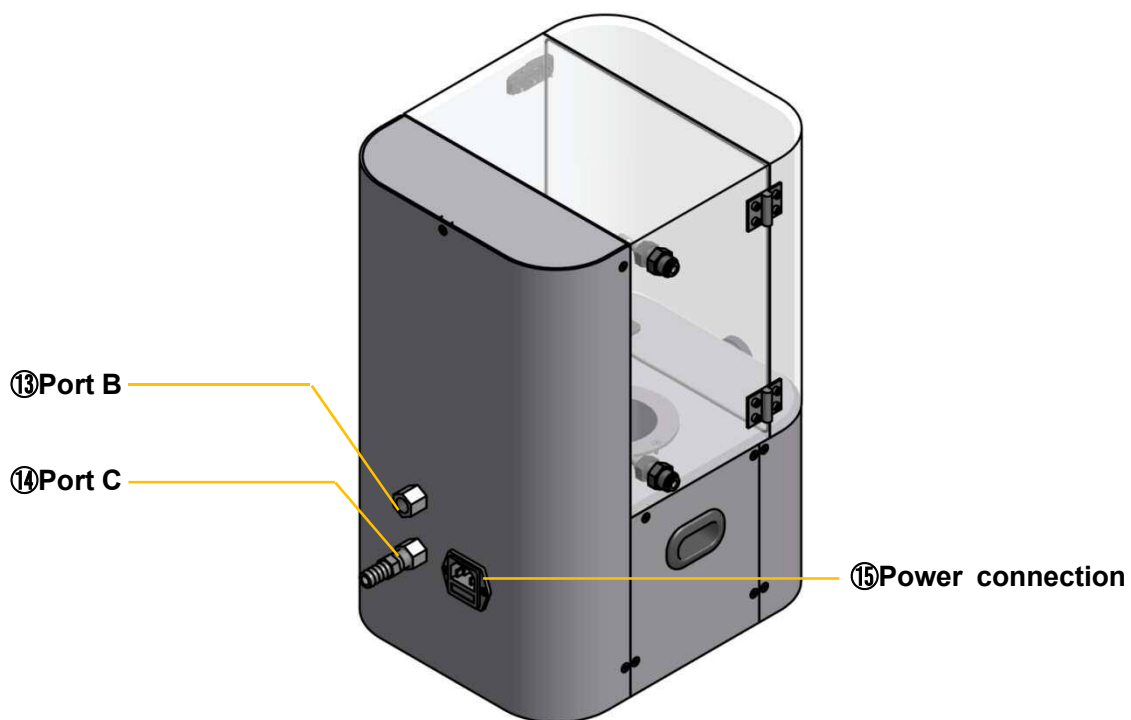







Part name	Function
⑬ Port B	To connect the circulation hose
⑭ Port C	To connect the vacuum hose
⑮ Power connection	To connect the power cord

*See P 7~8 for the reference of the part number in the description above.

Chapter 4) Before use / P 9~10

4-1 To confirm accessories

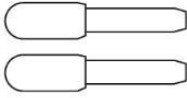
- Confirm all accessories below;
- Don't lose any accessories

<p>Aluminum beads Qty : 1</p> 	<p>Spiral Plug units Qty : 4</p> 	<p>Instruction Manual Qty : 1</p> 
<p>Hose splices *1 Qty : 2</p> 	<p>Plugs *2 Qty</p> 	<p>Power cord Qty : 1</p> 

*1 Please select a moderate a hose splice with outer diameter of 9mm or 12mm for the vacuum pump.

*2 On the shipment, the port A ① and the orifice ② inside are connected.

4-2 To prepare items

Please notice that these items below are not included in the product.

- Tools
- Vacuum hose
- Vacuum pump
- Container for concentration
- Cold trap
- Refrigerant

4-3 Preparing before use

1) Prepare aluminum beads

Please put aluminum beads in temperature control block ④.

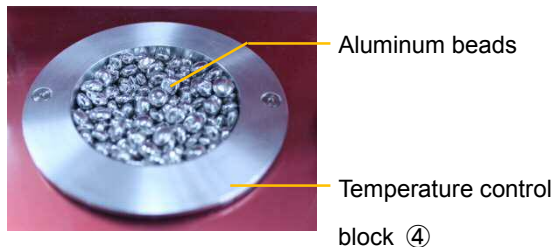

Don't use other aluminum beads to avoid troubles.

2) Connect the Spiral Plug unit and the joint

Please connect the Spiral Plug unit and the joint ③ until it clicks.

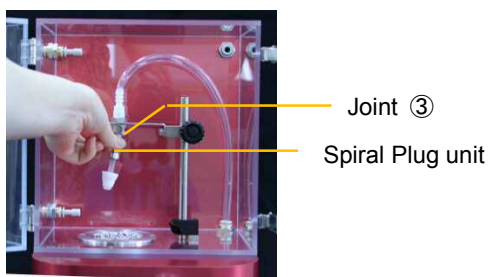

In case of taking out the Spiral Plug unit, push the metal point.

3) Connect the hose splice

Please choose a hose splice with the outer diameter of 9mm or 12mm.

Then, connect the hose splice and the port C ⑭

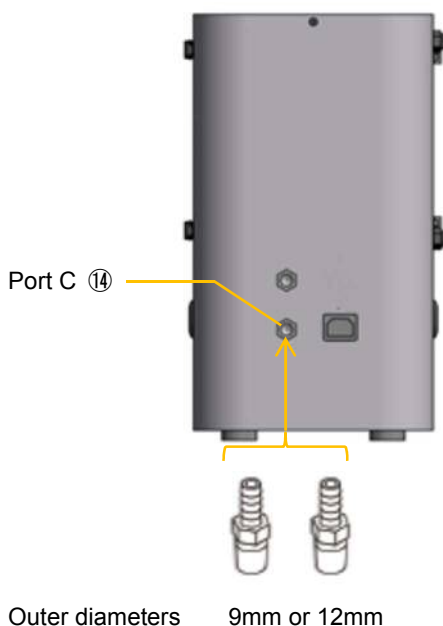

Please connect them firmly.

If you need to choose other size, please ask your local distributor.

4) Remove the plug

Please remove the plug from inside Port A ① and Orifice ②.

Then, please put on plugs outside them.

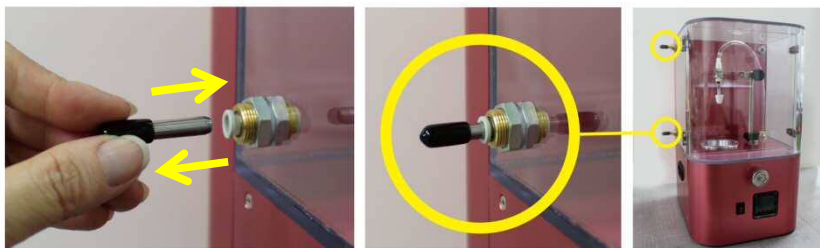

Chapter 5) How to use / P 11~30

Selecting concentration method

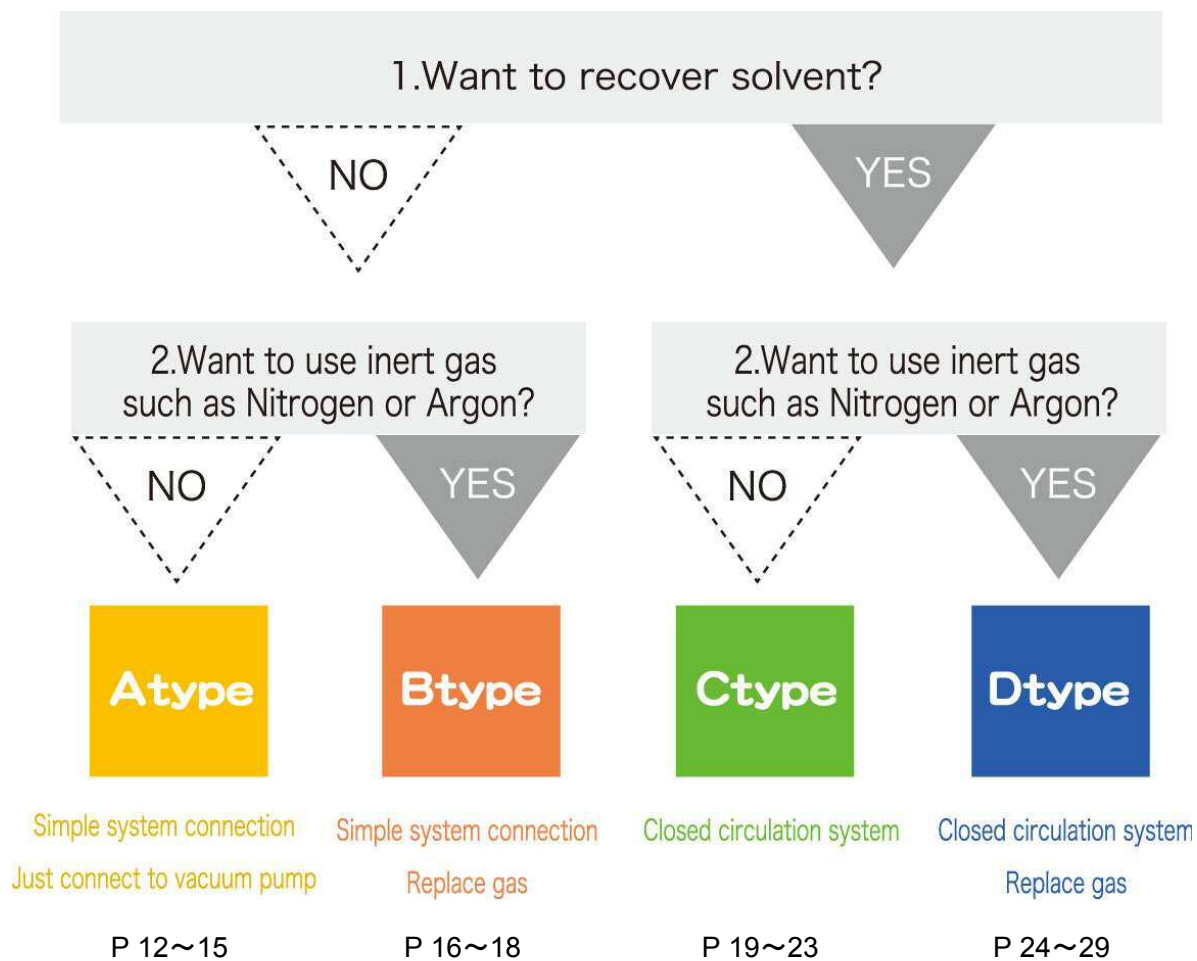



5-1 A Type Simple system connection P 12~15

Ex :



<u>Included items</u>	<u>Not included items</u>
<ul style="list-style-type: none">▪ Machine▪ Power cord	<ul style="list-style-type: none">▪ Vacuum pump▪ Vacuum hose▪ Container

5-1-1 Connecting method

 Warning	<ul style="list-style-type: none">▪ Turn off machine and pump power before connecting them with a vacuum hose.▪ Confirm specifications for power supply before use.
 Caution	<ul style="list-style-type: none">▪ Please confirm the vacuum pump works properly before use.▪ Please use an adequate and moderate vacuum hose.▪ Please avoid tension and bending of the vacuum hose and the power cord.▪ Please connect the power cord correctly.

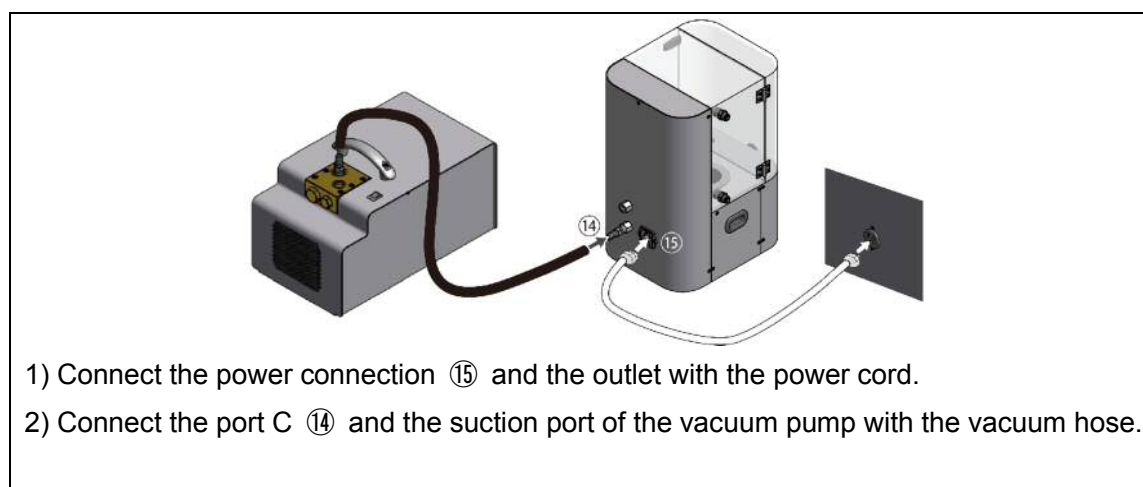

5-1-2 Set target temperature

 <p>Warning</p>	<ul style="list-style-type: none"> • Keep the max temperature below 100°C to avoid damages to the machine. • Set the target temperature above room temperature.
--	---

1) Turn on the Power for temperature control ⑤.



① Current temperature

② Target temperature

③ ▲ ▼ key for setting temperature

Select temperature from room temperature to 100°C *1 *2

*1 Please use this device after reaching target temperature.

*2 Please do not touch the key except for ▲ ▼ key. It may cause a malfunction.

5-1-3 To place the container

 <p>Caution</p>	<ul style="list-style-type: none"> • Don't touch the temperature control block, aluminum beads and the container immediately after using. There is a danger of burns, fire and / or an accident. • If you put samples in a container more than half container volume, the machine will suck up samples directly. This will damage the machine and pump. • Please place machine and container horizontally. • Please confirm the size of Spiral Plug unit size before use.
--	---

1) To open the cover

Please open the cover ⑥ with snap locks ⑦.

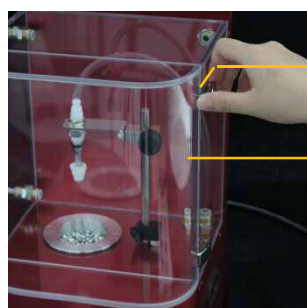

Snap lock ⑦

Cover ⑥

2) To place the container

Please set up the container in aluminum beads.

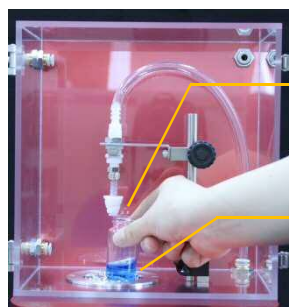

Container

Aluminum beads

Put samples in a container from quarter to half container volume.

3) To connect the Spiral Plug unit with the container

Please adjust a height according to your container the dial ⑨.

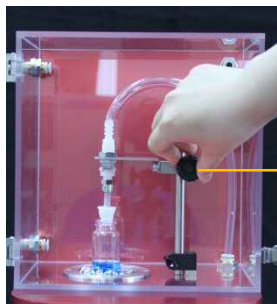

Dial ⑨

4) To close the cover

Please close the cover with snap locks ⑦.



5-1-4 Starting concentration



Caution

- In case of using temperature control, start concentration after reaching the target temperature.
- Please confirm to close the valve tightly before you begin concentration.
- To avoid sample loss and damages to machine and pump due to sudden suction, adjust gas influx with the valve gradually.
- If the machine sucks up samples directly, please close the valve immediately.
- Don't suck up dusts and foreign matters.

1) To turn on the vacuum pump

Please turn on the vacuum pump.

Close the valve tightly before you begin concentration.

If you use your pump, please confirm a manual provided by the manufacturer.

2) To adjust gas influx

Please adjust gas influx with the vacuum control valve ⑩.

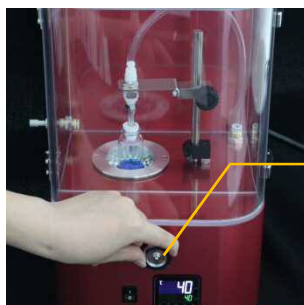

Vacuum control valve ⑩

To avoid sample loss and damages to machine and pump due to sudden suction, adjust gas influx with the valve gradually.

5-1-5 After finishing concentration

- 1) Close the vacuum control valve ⑪ tightly. Then, turn off the machine and vacuum pump.
- 2) Take out the container after cooling down the heated container.

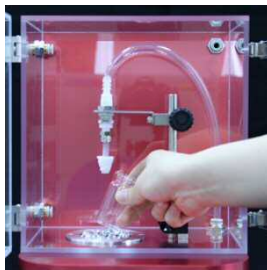

5-2 B Type Simple system connection 【Replacing gas】 P 16~18

The Smart Evaporator can replace the air inside with gas such as Nitrogen or Argon.

<u>Included items</u>	<u>Not included items</u>
<ul style="list-style-type: none"> ▪ Machine ▪ Power cord 	<ul style="list-style-type: none"> ▪ Vacuum pump ▪ Vacuum hose ▪ Container ▪ Gas tank, Gas line and etc. ▪ Gas tube (pressure tightness)

5-2-1 Connecting method

 <p>Caution</p>	<ul style="list-style-type: none"> ▪ Please connect the vacuum tube completely. ▪ Please take out plugs before replacing gas. ▪ In case of replacing gas, please leak the gas always.
--	--

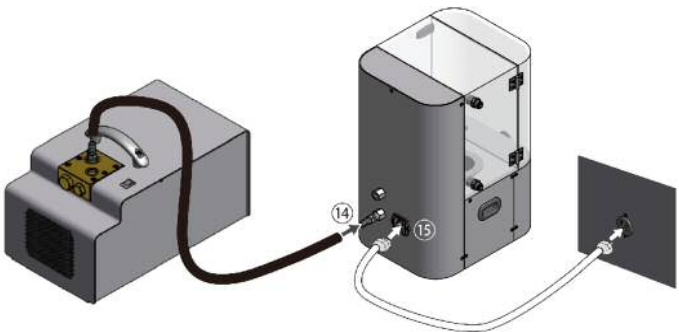

1) Connect the power connection ⑮ and the outlet with the power cord.

2) Connect the port C ⑭ and the suction port of vacuum pump with the vacuum hose.

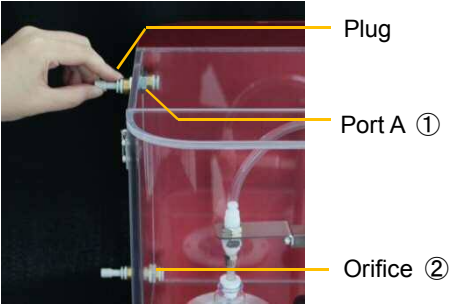
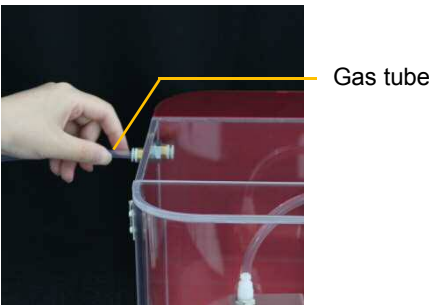
<p>3) To take out plugs</p> <p>Please take out plugs by pushing the root of the plug from the port A ① and Orifice ②.</p> 	<p>4) To connect the gas tube</p> <p>Connect the port A ① and the gas tank with the gas tube.</p> 
--	---

5-2-2 Set target temperature

 <p>Warning</p>	<ul style="list-style-type: none"> • Keep the max temperature below 100°C to avoid damages to the machine. • Set the target temperature above room temperature.
--	---

1) Turn on the Power for temperature control ⑤.



① Current temperature

② Target temperature

③ ▲ ▼ key for setting temperature

Select temperature from room temperature to 100°C *1 *2

*1 Please use this device after reaching target temperature.

*2 Please do not touch the key except for ▲ ▼ key. It may cause a malfunction.

5-2-3 To place the container

1) To open the cover

Please open the cover ⑥ with snap locks.

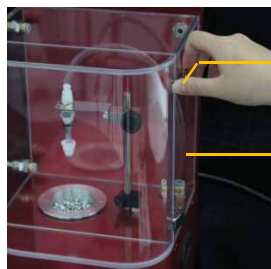

Snap lock ⑦

Cover ⑥

2) To place the container

Please set up the container in aluminum beads.

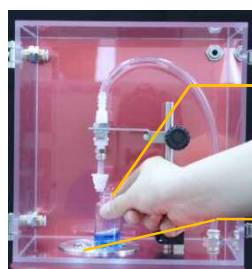

Container

Aluminum beads

Put samples in a container from quarter to half container volume.

3) To connect the Spiral Plug unit with the container

Please adjust a height according to your container the dial ⑨.

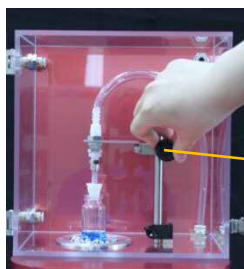

Dial ⑨

4) To close the cover

Please close the cover with snap locks ⑦.



5-2-4 Replacing gas

<p>1) To open a valve of a gas supply Please open a valve of a gas supply. Ex : Gas line Must have gas overflow.</p>	<p>2) To flow the gas Please start flowing gas about 2 min. at 10 L / min. *1 *1 Gas replacement with the system is not 100%. When replacing gas, only use the containers that fit Spiral Plug P1 or P2. (some work with P3.)</p>
--	---

5-2-5 Start concentration

<p>1) To turn on the vacuum pump Please turn on the vacuum pump. Close the valve tightly before you begin concentration. If you use your pump, please confirm a manual provided by a manufacturer.</p>	<p>2) To adjust gas influx Please adjust gas influx with the vacuum control valve ⑪.</p>  <p>Vacuum control valve ⑪</p> <p>To avoid sample loss and damages to machine and pump due to sudden suction, adjust gas influx with the valve gradually.</p>
--	---

5-2-6 After finishing concentration

- 1) Close the vacuum control valve ⑪ tightly. Then, turn off the machine and vacuum pump.
- 2) Then, close the valve of the gas supply.
- 3) Take out the container after cooling down the heated container.

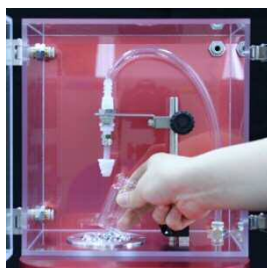

5-3 C Type Closed circulation system P 19~23

The Smart Evaporator can be used for the concentration within the closed circulation system.









Ex :

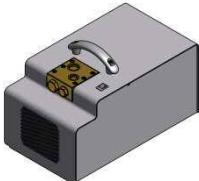

<u>Included items</u>	<u>Not included items</u>
<ul style="list-style-type: none"> ▪ Machine ▪ Power cord 	<ul style="list-style-type: none"> ▪ Circulation system ▪ Refrigerant ▪ Container

5-3-1 To confirm accessories

- To confirm all accessories below;
- Don't lose any accessories.



Vacuum pump Qty : 1 	Hose splices Qty : 2 Fine : For the exhaust port Thick : For the suction port  Fine Thick	Vacuum hose Qty : 1 
Cold trap Qty : 1 	Erlenmeyer flask Qty : 1 	Stand Qty : 1 
Holder Qty : 2 	Cut ring Qty : 1 	Clamp Qty : 1 

Hose splice
(For port of circulation)

Qty : 1



5-3-2 Connecting method

 Warning	<ul style="list-style-type: none">• Don't use cold trap with "liquid nitrogen" because it could cause explosion due to the liquefaction of oxygen in air.• Must confirm all connecting method before use.
 Caution	<ul style="list-style-type: none">• As much as possible, use the Smart Evaporator with our recommendation items such as pump, cold trap and etc.

5-3-2-1 Preparing the vacuum pump

- 1) Connect the thick hose splice to the suction port of vacuum pump.
- 2) Connect the fine hose splices to the exhaust port of vacuum pump.

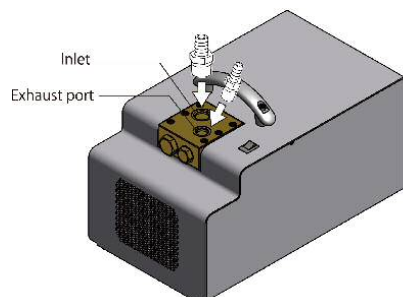

5-3-2-2 Preparing the cold trap

Connect the cold trap and the stand with the clamp.

5-3-2-3 Preparing Smart Evaporator

- 1) Connect the hose splice to port B ⑬.
- 2) Connect the hose splice to port C ⑭.
- 3) Connect the power connection ⑮ and the power cord.

*Two hose splices are the same ones.

See P 8~9 for the reference of the part number in the description above.

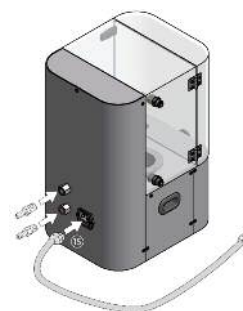

5-3-2-4 Connection all accessories

<Step1 : Connect the machine and the vacuum pump>

- 1) Connect the power connection ⑮ and the outlet with the power cord.
- 2) Connect the port C ⑭ and the suction port of the vacuum pump with the vacuum hose.

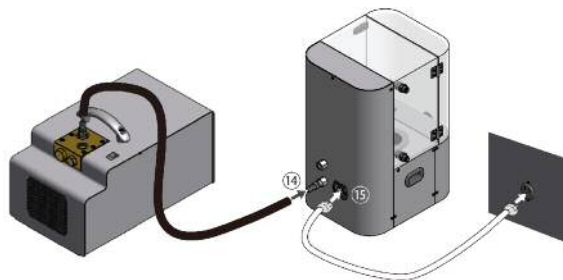

<Step2 : Connect the vacuum pump and cold trap>

Connect the exhaust port of vacuum pump and cold trap (under) with vacuum hose.

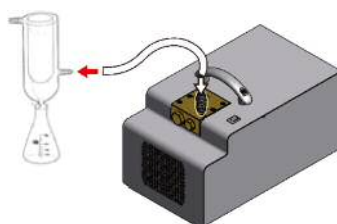

<Step3 : Connect the machine and cold trap>

Connect the port B and the cold trap (upper) with vacuum hose.



<Step4 : Connect the power connection>

Connect the outlet with the power cord.

5-3-3 Set target temperature



Warning

- Keep the max temperature below 100°C to avoid damages to the machine.
- Set the target temperature above room temperature.

- 1) Turn on the Power for temperature control ⑤.



① Current temperature

② Target temperature

- ③ ▲ ▼ key for setting temperature

Select temperature from room temperature to 100°C *1 *2

*1 Please use this device after reaching target temperature.

*2 Please do not touch the key except for ▲ ▼ key. It may cause a malfunction.

5-3-4 Starting concentration

(i) Preparing refrigerant

1) Put the refrigerant in the cold trap

Don't use cold trap with "liquid nitrogen" because it could cause an explosion due to the liquefaction of oxygen in air.



(ii) To place the container

1) To open the cover

Please open the cover ⑥ with snap locks.

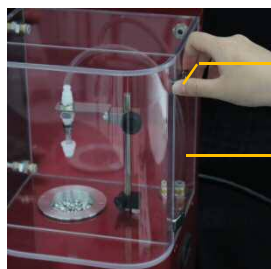

Snap lock ⑦

Cover ⑥

2) To place the container

Please set up the container on aluminum beads.

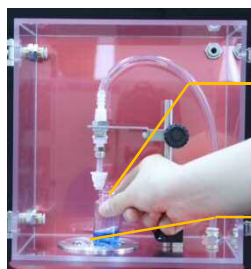

Container

Aluminum beads

Put samples in a container from quarter to half container volume.

3) To connect the Spiral Plug unit with the container

Please adjust a height according to your container the dial ⑨.

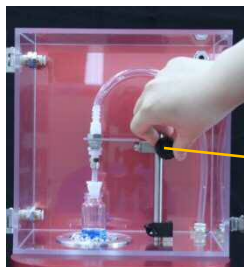

Dial ⑨

4) To close the cover

Please close the cover with snap locks ⑦.



5-3-5 Start concentration

1) To turn on the vacuum pump

Please turn on the vacuum pump.

Close the valve tightly before you begin concentration.

If you use your pump, please confirm a manual provided by a manufacturer.

2) To adjust gas influx

Please adjust gas influx with the vacuum control valve ⑪.

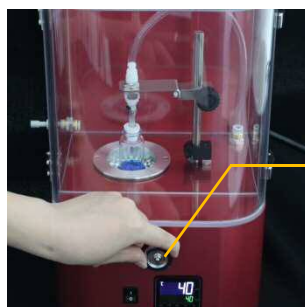

Vacuum control valve ⑪

To avoid sample loss and damages to machine and pump due to sudden suction, adjust gas influx with the valve gradually.

5-3-6 After finishing concentration

- 1) Close the vacuum control valve ⑪ tightly. Then, turn off the machine and vacuum pump.
- 2) Take out the container after cooling down the heated container.

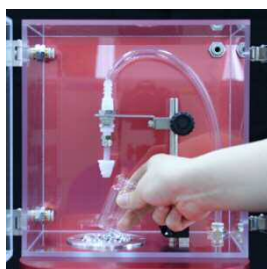







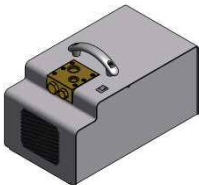

5-4 D Type Closed circulation system 【Replacing gas】 P 24~29

The Smart Evaporator can be used for the concentration within the closed circulation system. In addition, it can replace the air within the system with gas such as Nitrogen or Argon.

<u>Included items</u>	<u>Not included items</u>
<ul style="list-style-type: none"> • Machine • Power cord 	<ul style="list-style-type: none"> • Circulation system • Refrigerant • Container • Gas tank, Gas line and etc. • Gas tube (pressure tightness)

5-4-1 To confirm accessories

- To confirm all accessories below;
- Don't lose any accessories.



<p>Vacuum pump Qty : 1</p> 	<p>Hose splices Qty : 2</p> <p>Fine : For the exhaust port Thick : For the suction port</p>  <p>Fine Thick</p>	<p>Vacuum hose Qty : 1</p> 
<p>Cold trap Qty : 1</p> 	<p>Erlenmeyer flask Qty : 1</p> 	<p>Stand Qty : 1</p> 
<p>Holder Qty : 2</p> 	<p>Cut ring Qty : 1</p> 	<p>Clamp Qty : 1</p> 

Hose splice
(For port of circulation)

Qty : 1



5-4-2 Connecting method

 Warning	<ul style="list-style-type: none">• Don't use cold trap with "liquid nitrogen" because it could cause explosion due to the liquefaction of oxygen in air.• Must confirm all connecting method before use.
 Caution	<ul style="list-style-type: none">• As much as possible, use the Smart Evaporator with our recommendation items such as pump, cold trap and etc.

5-4-2-1 Preparing the vacuum pump

- 1) Connect the thick hose splice to the suction port of vacuum pump.
- 2) Connect the fine hose splices to the exhaust port of vacuum pump.

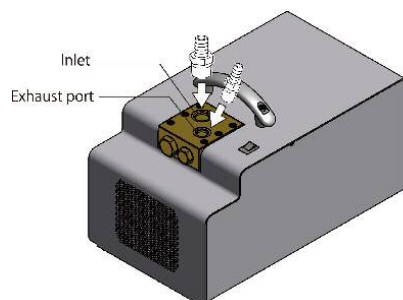

5-4-2-2 Preparing the cold trap

Connect the cold trap and the stand with the clamp.

5-4-2-3 Preparing Smart Evaporator

- 1) Connect the hose splice to port B ⑬.
- 2) Connect the hose splice to port C ⑭.
- 3) Connect the power connection ⑮ and the power cord.

*Two hose splices are the same ones.

See P 8~9 for the reference of the part number in the description above.



5-4-2-4 Connection all accessories

<Step1 : Connect the machine and the vacuum pump>

- 1) Connect the power connection ⑮ and the outlet with the power cord.
- 2) Connect the port C ⑭ and the suction port of the vacuum pump with the vacuum hose.

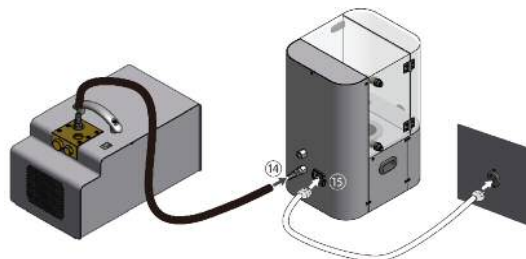

<Step2 : Connect the vacuum pump and cold trap>

Connect the exhaust port of vacuum pump and cold trap (Under) with vacuum hose.

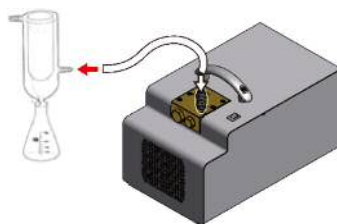

<Step3 : Connect the machine and cold trap>

Connect the port B and the cold trap (upper) with vacuum hose.



<Step4 : Connect the power connection>

Connect the outlet with the power cord.

5-4-2-5 Connection the gas tank

1) To take out plugs

Please take out plugs by pushing the root of the plug from the port A ① and Orifice ②.

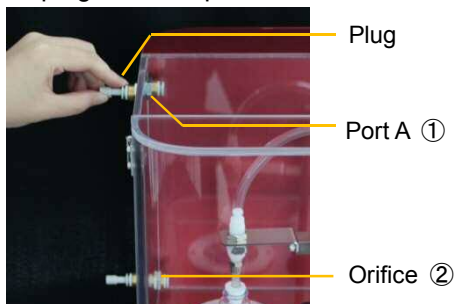

2) To connect the gas tube

Connect the port A ① and the gas tank with the gas tube.

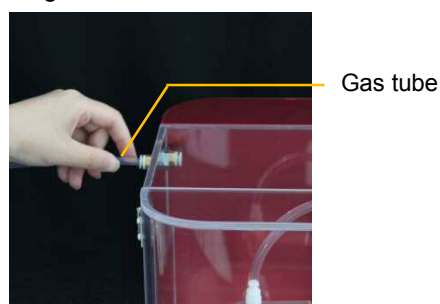

5-4-3 Set target temperature

 <p>Warning</p>	<ul style="list-style-type: none"> • Keep the max temperature below 100°C to avoid damages to the machine. • Set the target temperature above room temperature.
--	---

1) Turn on the Power for temperature control ⑤.



① Current temperature

② Target temperature

③ ▲ ▼ key for setting temperature

Select temperature from room temperature to 100°C *1 *2

*1 Please use this device after reaching target temperature.

*2 Please do not touch the key except for ▲ ▼ key. It may cause a malfunction.

5-4-4 Starting concentration

(i) Preparing refrigerant

1) Put the refrigerant in the cold trap

Don't use cold trap with "liquid nitrogen" because it could cause an explosion due to the liquefaction of oxygen in air.



(ii) To place the container

1) To open the cover

Please open the cover ⑥ with snap locks.

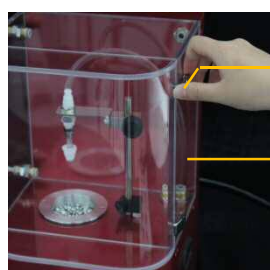

Snap lock ⑦

Cover ⑥

2) To place the container

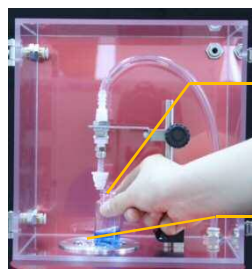

Please set up the container on aluminum beads.



Container

Aluminum beads

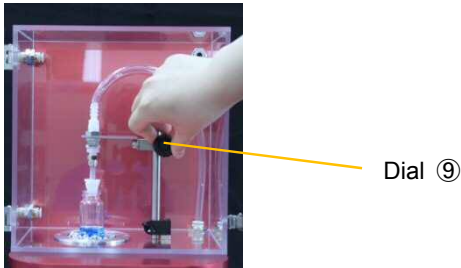
Put samples in a container from quarter to half container volume.

<p>3) To connect the Spiral Plug unit with the container</p> <p>Please adjust a height according to your container the dial ⑨.</p>  <p>Dial ⑨</p>	<p>4) To close the cover</p> <p>Please close the cover with snap locks ⑦.</p> 
---	--

5-4-5 Replacing gas

<p>1) To open a valve of a gas supply</p> <p>Please open a valve of a gas supply.</p> <p>Ex : Gas line</p> <p>Must have gas overflow.</p>	<p>2) To flow the gas</p> <p>Please start flowing gas about 2 min. at 10 L / min. *1</p> <p>*1 Gas replacement with the system is not 100%. When replacing gas, only use the containers that fit Spiral Plug P1 or P2. (some work with P3.)</p>
<p>3) Put on a plug to the Orifice</p> <p>Please put on a plug to the Orifice ②.</p>	<p>4) Remove the gas tube</p> <p>Please remove the gas tube. Then, put on a plug to the Port A ①.</p>

5-4-6 Start concentration

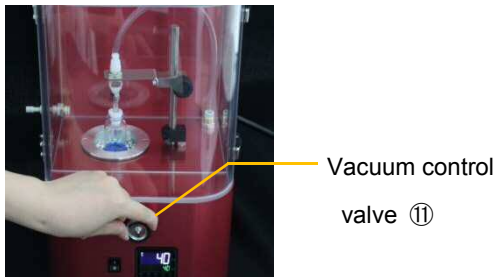
<p>1) To turn on the vacuum pump</p> <p>Please turn on the vacuum pump.</p> <p>Close the valve tightly before you begin concentration.</p> <p>If you use your pump, please confirm a manual provided by a manufacturer.</p>	<p>2) To adjust gas influx</p> <p>Please adjust gas influx with the vacuum control valve ⑩.</p>  <p>Vacuum control valve ⑩</p> <p>To avoid sample loss and damages to machine and pump due to sudden suction, adjust gas influx with the valve gradually.</p>
--	---

5-4-7 After finishing concentration

- 1) Close the vacuum control valve ⑪ tightly. Then, turn off the machine and vacuum pump.
- 2) Then, close the valve of the gas supply.
- 3) Take out the container after cooling down the heated container.

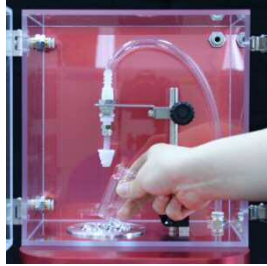

Chapter 6) Troubleshooting / P 30

Error type	Inspection	Treatment
Can't use and set temperature	Check the power cord.	Please connect the power connection and the outlet with power cord firmly.
If the temperature control block is too hot to touch	Check the duration of the use.	Please turn off the power.
Sucking and splash sample	Check the gas influx.	Please adjust gas influx gradually after closing the valve tightly once.
Can't generate the spiral air flow	Check the connection between vacuum pump and vacuum hose.	Please connect the vacuum pump and vacuum hose firmly.
	Check the connecting condition between the Spiral Plug unit and the container.	Please connect the joint and Spiral Plug unit firmly.
	Check the flow rate of the vacuum pump.	Please confirm the flow rate of the vacuum pump by referring to the manufacturer's instruction .

***If you can't resolve any problems, please feel free to ask our local distributor.**

Chapter 7) Question and Answer / P 31

Q.1 How long can I use the Spiral Plug unit?

Answer:

It depends on the frequency of use.

However, we recommend to replace the old Spiral Plug unit with a new one periodically.

Q.2 I'm worried about the contamination from the Spiral Plug unit.

Answer:

It depends on the solvent.

However, materials (PTFE, PFA and THV) are resistance to organic solvents.

Q.3 Which containers are recommended?

Answer:

The Smart Evaporator can be used with various types of containers.

We recommend using flat-bottom containers for efficient concentration.

Q.4 Do you have a recommended pump?

Answer:

Yes, we have a recommended pump.

Please ask our local distributor.

Q.5 How do I wash the plug unit?

Answer:

Please wash with moderate solvent or pure water according to your sample.

Please use it after the complete

In addition, it can be put in autoclaves or ultrasonic washing machines.

Chapter 8) Limited Warranty / P 32

We are willing to repair the machine in the case of troubles caused by normal use abided by quality assurance provisions below. Please contact the local distributor from which you purchased it, then provide it with product code and details such as the date of purchase and troubles.

8.1 Parts for Quality Assurance

Machine

8.2 Term of Guarantee

1 year after the purchase

*Please notice that the fees for repairing are charged after the period, which includes costs for parts, transportation and repairing work.

8.3 Exception for Quality Assurance

Please note that you are liable for the cost of repairs in the case below.

- Troubles and damages caused by careless use
- Troubles and damages caused by accidents such as falling and shock during transportation after the purchase
- Troubles and damages because of using non-designated voltage and frequency in this manual
- Troubles and damages because of unsuitable repairs
- Troubles and damages because of the alternation to machine and disassembling
- Unrelated alternations to the function and performance such as color change, noise and vibration
- Reaching part life due to the frequent use of the machine
- Consumable parts
- Troubles and damages due to natural disaster, fire and other external causes
- Troubles and damages caused by storing the machine under harsh conditions such as exposure to high temperature, high humidity, harmful chemicals, corrosive gas
- Troubles and damages caused by contaminants with sand, mud, water and reagents
- Troubles and damages caused by using the machine for other applications that are not described in this manual

Chapter 9) Product Specifications / P 33

Product name	Smart Evaporator C1
Product code	C1-[Color]-120-A
Outer size (mm)	W 220 * D 270 * H 389
Weight (kg)	Net 5.3kg Gross 8.5kg
Rating	AC120V 50/60Hz 100W 1A
Wetted materials	Body : PTFE, SUS304, C3604, THV, PBT, NBR, Denatured PTFE Spiral Plug Unit : PTFE, PFA, POM, FKM
Number of sample	One
Heating control temperature	From room temperature to 100°C
Operating temperature limits	From 10°C to 40 °C
Operating humidity limits	From 20 % to 70 % (No condensation)

*If some parts of this explanation may not be applied to your machine, please ask your local distributor.

Distributor

BioChromato USA

<http://biochromato.com/>

E-mail: info@biochromato.com

7098 Miratech Drive,

Ste. 100,

San Diego, CA 92121

TEL : (858) 385-2006

Manufacturer

BioChromato, Inc.

<http://www.bicr.biz/>

E-mail: info@bicr.co.jp

1-12-19 Honcho,

Fujisawa-shi, Kanagawa-Ken,

2510053, Japan

TEL : 0081-466-23-8382