

Model 48i

Instruction Manual

Gas Filter Correlation CO Analyzer

Part Number 101891-00

18Dec2010



CE

Thermo
SCIENTIFIC

© 2007 Thermo Fisher Scientific Inc. All rights reserved.

Specifications, terms and pricing are subject to change. Not all products are available in all countries. Please consult your local sales representative for details.

Thermo Fisher Scientific
Air Quality Instruments
27 Forge Parkway
Franklin, MA 02038
1-508-520-0430
www.thermo.com/aqi

WEEE Compliance

This product is required to comply with the European Union's Waste Electrical & Electronic Equipment (WEEE) Directive 2002/96/EC. It is marked with the following symbol:



Thermo Fisher Scientific has contracted with one or more recycling/disposal companies in each EU Member State, and this product should be disposed of or recycled through them. Further information on Thermo Fisher Scientific's compliance with these Directives, the recyclers in your country, and information on Thermo Fisher Scientific products which may assist the detection of substances subject to the RoHS Directive are available at: www.thermo.com/WEEERoHS.

Reference Method Designation

The Thermo Scientific Model 48*i* is designated by the United States Environmental Protection Agency (USEPA) as a Reference Method for CO as set forth in the U.S. Environmental Protection Agency regulations at Title 40, Part 53 of the U.S. Code of Federal Regulations.

Designated Reference Method Number: RFCA-0981-054

EPA Designation Date: September 23, 1981 (amended for Model 48*i*)

The Model 48*i* CO Analyzer meets EPA reference designation requirements when operated with the following:

Range	0-1 to 100 ppm
Averaging Time	10 to 300 seconds
Temperature Range	20 to 35 °C
Line Voltage	90 to 110 Vac @50/60 Hertz 105 to 125 Vac @50/60 Hertz 210 to 250 Vac @50/60 Hertz
Pressure Compensation	ON or OFF
Temperature Compensation	ON or OFF
Flow Rate	0.5 to 2 L/min
RS-232/RS-485 Interface	

With or without the following options:

Teflon Particulate Filter
Internal Zero/Span and Sample Valves
Internal Zero Air Scrubber
Rack Mounts
I/O Expansion Board

About This Manual

This manual provides information about installing, operating, maintaining, and servicing the Model 48i CO gas analyzer. It also contains important alerts to ensure safe operation and prevent equipment damage. The manual is organized into the following chapters and appendices to provide direct access to specific operation and service information.

- Chapter 1 “[Introduction](#)” provides an overview of product features, describes the principles of operation, and lists the specifications.
- Chapter 2 “[Installation](#)” describes how to unpack, setup, and startup the analyzer.
- Chapter 3 “[Operation](#)” describes the front panel display, the front panel pushbuttons, and the menu-driven firmware.
- Chapter 4 “[Calibration](#)” provides the procedures for calibrating the analyzer and describes the required equipment.
- Chapter 5 “[Preventive Maintenance](#)” provides maintenance procedures to ensure reliable and consistent instrument operation.
- Chapter 6 “[Troubleshooting](#)” presents guidelines for diagnosing analyzer failures, isolating faults, and includes recommended actions for restoring proper operation.
- Chapter 7 “[Servicing](#)” presents safety alerts for technicians working on the analyzer, step-by-step instructions for repairing and replacing components, and a replacement parts list. It also includes contact information for product support and technical information.
- Chapter 8 “[System Description](#)” describes the function and location of the system components, provides an overview of the firmware structure, and includes a description of the system electronics and input/output connections.
- Chapter 9 “[Optional Equipment](#)” describes the optional equipment that can be used with this analyzer.
- Appendix A “[Warranty](#)” is a copy of the warranty statement.
- Appendix B “[C-Link Protocol Commands](#)” provides a description of the C-Link protocol commands that can be used to remotely control an analyzer using a host device such as a PC or datalogger.

- Appendix C “[MODBUS Protocol](#)” provides a description of the MODBUS Protocol Interface and is supported both over RS-232/485 (RTU protocol) as well as TCP/IP over Ethernet.
- Appendix D “[Gesytex \(Bayern-Hessen\) Protocol](#)” provides a description of the Gesytex (Bayern-Hessen or BH) Protocol Interface and is supported both over RS-232/485 as well as TCP/IP over Ethernet.





Safety

Review the following safety information carefully before using the analyzer. This manual provides specific information on how to operate the analyzer, however, if the analyzer is used in a manner not specified by the manufacturer, the protection provided by the equipment may be impaired.

Safety and Equipment Damage Alerts



This manual contains important information to alert you to potential safety hazards and risks of equipment damage. Refer to the following types of alerts you may see in this manual.

Safety and Equipment Damage Alert Descriptions

Alert	Description
 DANGER	A hazard is present that could result in death or serious personal injury if the warning is ignored. ▲
 WARNING	A hazard or unsafe practice could result in serious personal injury if the warning is ignored. ▲
 CAUTION	A hazard or unsafe practice could result in minor to moderate personal injury if the warning is ignored. ▲
 Equipment Damage	A hazard or unsafe practice could result in property damage if the warning is ignored. ▲

Safety and Equipment Damage Alerts in this Manual

Alert	Description
 WARNING	<p>The Model 48i is supplied with a three-wire grounded power cord. Under no circumstances should this grounding system be defeated. ▲</p> <p>If the equipment is operated in a manner not specified by the manufacturer, the protection provided by the equipment may be impaired. ▲</p> <p>The service procedures in this manual are restricted to qualified service personnel only. ▲</p>

Alert	Description
 <p>CAUTION</p>	<p>If the LCD panel breaks, do not let the liquid crystal contact your skin or clothes. If the liquid crystal contacts your skin or clothes, wash it off immediately using soap and water. ▲</p>
 <p>Equipment Damage</p>	<p>Do not attempt to lift the analyzer by the cover or other external fittings. ▲</p> <p>Disconnect the serial cable before changing RS-232 and RS-485 selection to prevent damage to any equipment currently connected to the analyzer. ▲</p> <p>Some internal components can be damaged by small amounts of static electricity. A properly grounded antistatic wrist strap must be worn while handling any internal component. ▲</p> <p>Do not use solvents or other cleaning products to clean the outside case. ▲</p> <p>Do not remove the LCD panel or frame from the LCD module. ▲</p> <p>The LCD polarizing plate is very fragile, handle it carefully. ▲</p> <p>Do not wipe the LCD polarizing plate with a dry cloth, as it may easily scratch the plate. ▲</p> <p>Do not use alcohol, acetone, MEK or other ketone based or aromatic solvent to clean the LCD module, but rather use a soft cloth moistened with a naphtha cleaning solvent. ▲</p> <p>Do not place the LCD module near organic solvents or corrosive gases. ▲</p> <p>Do not shake or jolt the LCD module. ▲</p>

FCC Compliance

Changes or modifications to this unit not expressly approved by the party responsible for compliance could void the user's authority to operate the equipment.

Note This equipment has been tested and found to comply within the limits for a Class A digital device, pursuant to Part 15 of the FCC Rules. These limits are designed to provide reasonable protection against harmful interference when the equipment is operated in a commercial environment. This equipment generates, uses, and can radiate radio frequency energy and, if not installed and used in accordance with the instruction manual, may cause harmful interference to radio communications. Operation of this equipment in a residential area is likely to cause harmful interference, in

which case the user will be required to correct the interference at his or her own expense. ▲

WEEE Symbol

The following symbol and description identify the WEEE marking used on the instrument and in the associated documentation.

Symbol	Description
	Marking of electrical and electronic equipment which applies to waste electrical and electronic equipment falling under the Directive 2002/96/EC (WEEE) and the equipment that has been put on the market after 13 August 2005. ▲



Where to Get Help

Service is available from exclusive distributors worldwide. Contact one of the phone numbers below for product support and technical information or visit us on the web at www.thermo.com/aqi.

1-866-282-0430 Toll Free

1-508-520-0430 International

Contents

Chapter 1	Introduction.....	1-1
	Principle of Operation	1-2
	Specifications	1-3
Chapter 2	Installation	2-1
	Lifting.....	2-1
	Unpacking and Inspection	2-1
	Setup Procedure.....	2-3
	Connecting External Devices	2-5
	Terminal Board PCB Assemblies.....	2-5
	I/O Terminal Board.....	2-5
	D/O Terminal Board.....	2-7
	25-Pin Terminal Board	2-8
	Startup.....	2-9
Chapter 3	Operation.....	3-1
	Display.....	3-1
	Pushbuttons.....	3-2
	Soft Keys.....	3-3
	Alphanumeric Entry Screen	3-4
	Firmware Overview.....	3-4
	Power-Up Screen	3-6
	Run Screen.....	3-6
	Custom Run Screens.....	3-7
	Main Menu.....	3-8
	Range Menu	3-8
	Single Range Mode.....	3-9
	Dual Range Mode.....	3-10
	Auto Range Mode.....	3-11
	Gas Units.....	3-13
	CO Range.....	3-14
	Set Custom Ranges	3-15
	Custom Ranges.....	3-15
	Averaging Time.....	3-16
	Calibration Factors Menu	3-16
	CO Background.....	3-17
	CO Coefficient	3-18
	O ₂ Background	3-18
	O ₂ Coefficient.....	3-19

Reset User Calibration Defaults	3-20
Calibration Menu	3-20
Calibrate CO Background.....	3-21
Calibrate CO Coefficient	3-21
Zero/Span Check	3-22
Next Time	3-22
Period Hours.....	3-23
Total Duration Hour	3-23
Zero/Span/Purge Duration Minutes	3-23
Zero/Span Averaging Time	3-24
Zero/Span Calibration Reset	3-24
Zero/Span Ratio.....	3-24
Calibrate O ₂ Background	3-25
Calibrate O ₂ Coefficient.....	3-25
Instrument Controls Menu	3-25
Datalogging Settings	3-26
Select Srec/Lrec	3-27
View Logged Data.....	3-27
Number of Records.....	3-27
Date and Time.....	3-28
Erase Log	3-29
Select Content.....	3-29
Choose Field Data.....	3-29
Concentrations.....	3-30
Corrected Concentrations	3-30
Other Measurements.....	3-31
Analog Inputs.....	3-31
Commit Content	3-32
Reset to Default Content	3-32
Configure Datalogging.....	3-33
Logging Period Min	3-33
Memory Allocation Percent.....	3-33
Data Treatment	3-34
Flag Status Data	3-34
Communication Settings.....	3-35
Serial Settings.....	3-35
Baud Rate	3-35
Data Bits.....	3-36
Parity	3-36
Stop Bits	3-36
RS-232/RS-485 Selection.....	3-37
Instrument ID.....	3-37
Gesytac Serial No.....	3-38
Communication Protocol.....	3-38
Streaming Data Configuration	3-39
Streaming Data Interval	3-40

Add Labels	3-40
Prepend Timestamp	3-40
Add Flags	3-40
Choose Stream Data Item	3-41
Concentrations	3-41
Corrected Concentrations	3-41
Other Measurements	3-42
Analog Inputs	3-42
TCP/IP Settings	3-43
Use DHCP	3-43
IP Address	3-44
Netmask	3-44
Default Gateway	3-44
Host Name	3-45
Network Time Protocol Server	3-45
I/O Configuration	3-45
Output Relay Settings	3-46
Logic State	3-46
Instrument State	3-47
Alarms	3-47
Non-Alarm	3-48
Digital Input Settings	3-48
Logic State	3-49
Instrument Action	3-49
Analog Output Configuration (Select Channel)	3-49
Allow Over/Under Range	3-50
Analog Output Configuration (Select Action)	3-50
Select Range	3-51
Minimum and Maximum Value	3-51
Choose Signal to Output	3-52
Analog Input Configuration	3-54
Descriptor	3-54
Units	3-55
Decimal Places	3-55
Number of Table Points	3-55
Table Point	3-56
Volts	3-56
User Value	3-57
Temperature Compensation	3-57
Pressure Compensation	3-58
O ₂ Compensation	3-58
Screen Contrast	3-59
Service Mode	3-59
Date/Time	3-60
Timezone	3-60
Diagnostics Menu	3-61

Program Versions	3-61
Voltages	3-62
Motherboard Voltages.....	3-62
Interface Board Voltages	3-62
I/O Board Voltages	3-63
Temperatures	3-63
Pressure	3-63
Flow.....	3-64
Sample/Reference Ratio	3-64
AGC Intensity.....	3-64
Motor Speed	3-65
O ₂ Sensor Readings.....	3-65
Analog Input Readings.....	3-65
Analog Input Voltages.....	3-66
Digital Inputs.....	3-66
Relay States	3-66
Test Analog Outputs.....	3-67
Set Analog Outputs.....	3-67
Instrument Configuration	3-67
Contact Information	3-68
Alarms Menu	3-68
Internal Temperature.....	3-69
Min and Max Internal Temperature Limits.....	3-69
Bench Temperature.....	3-70
Min and Max Bench Temperature Limits	3-70
Pressure.....	3-70
Min and Max Pressure Limits	3-71
Sample Flow	3-71
Min and Max Sample Flow Limits	3-72
Bias Voltage	3-72
Min and Max Bias Voltage Limits.....	3-72
AGC Intensity.....	3-73
Min and Max AGC Intensity Limits	3-73
Motor Speed	3-73
Zero and Span Check.....	3-74
Max Zero and Span Offset	3-74
Zero and Span Auto Calibration	3-74
Concentration.....	3-75
Min and Max Concentration Limits	3-75
Min Trigger Concentration.....	3-76
O ₂ Concentration.....	3-76
Min and Max O ₂ Concentration Limits	3-76
Min Trigger	3-77
External Alarms.....	3-77
Service Menu	3-78
Range Mode Select.....	3-78

Pressure Calibration 3-79
 Calibrate Pressure Zero 3-79
 Calibrate Pressure Span 3-80
 Restore Default Pressure Calibration 3-80
 Flow Calibration 3-81
 Calibrate Flow Zero 3-81
 Calibrate Flow Span 3-81
 Restore Default Flow Calibration 3-82
 Initial Sample/Reference Ratio 3-82
 Multi-Point Calibration 3-83
 Calibrate Point 1/2/3 3-83
 Coefficients 3-84
 Default Coefficients 3-84
 Preamp Board Calibration 3-84
 Temperature Calibration 3-85
 Analog Output Calibration 3-85
 Analog Output Calibrate Zero 3-86
 Analog Output Calibrate Full-Scale 3-86
 Analog Input Calibration 3-87
 Analog Input Calibrate Zero 3-87
 Analog Input Calibrate Full-Scale 3-88
 O₂ Correction Concentration 3-88
 Dilution Ratio 3-89
 Setup Run Screens 3-89
 Edit Run Screen 3-90
 Edit Title 3-90
 Enabled 3-90
 Number of Items 3-91
 Select Run Screen Item 3-91
 Concentrations 3-92
 Corrected Concentrations 3-92
 Other Measurements 3-93
 Analog Inputs 3-93
 Display Pixel Test 3-93
 Restore User Defaults 3-94
 Password 3-94
 Set Password 3-95
 Lock Instrument 3-95
 Lock/Unlock and Local/Remote Operation 3-95
 Change Password 3-96
 Remove Password 3-96
 Unlock Instrument 3-96

Chapter 4 Calibration..... 4-1
 Equipment Required 4-1
 CO Concentration Standard 4-1

Zero Air Generator.....	4-1
Compression	4-2
Drying	4-2
Scrubbing.....	4-2
Flow Meter(s) and Controller(s).....	4-2
Pressure Regulator for CO Standard Cylinder	4-2
Mixing Chamber.....	4-3
Output Manifold	4-3
Pre-Calibration	4-3
Calibration	4-3
Connect the Instrument.....	4-3
Zero Adjust	4-4
Span Adjust.....	4-5
Calibration Frequency.....	4-6
Periodic Zero and Span Checks.....	4-6
HI and LO Multi-Point Calibration	4-7
Default Coefficients	4-7
Cal Point 1, 2, and 3 Adjust.....	4-7
References	4-9

Chapter 5 Preventive Maintenance5-1

Safety Precautions	5-1
Replacement Parts.....	5-2
Cleaning the Outside Case.....	5-2
Cleaning the Optics	5-2
IR Source Replacement	5-3
Fan Filter Inspection and Cleaning	5-3
Leak Test and Pump Check Out.....	5-4
External Leaks	5-4
Leaks Across the Optional Zero/Span and Sample Solenoid Valves..	5-5
Pump Rebuilding.....	5-5
Disassembly	5-5
Assembly with New Diaphragm and Valve.....	5-8

Chapter 6 Troubleshooting.....6-1

Safety Precautions	6-1
Troubleshooting Guides.....	6-1
Board-Level Connection Diagrams	6-5
Connector Pin Descriptions	6-7
Service Locations.....	6-20

Chapter 7 Servicing.....7-1

Safety Precautions	7-3
Firmware Updates.....	7-4
Accessing the Service Mode.....	7-4

Replacement Parts List 7-4
 Cable List..... 7-6
 External Device Connection Components 7-6
 Removing the Measurement Case Assembly and Lowering the Partition
 Panel..... 7-8
 Fuse Replacement 7-9
 Fan/Filter Replacement 7-10
 IR Source Replacement 7-11
 Filter Wheel Replacement 7-12
 Chopper Motor Replacement..... 7-14
 Optical Bench Replacement 7-15
 Optical Switch Replacement 7-16
 Bench Heater Assembly Replacement 7-17
 Detector/Preamplifier Assembly Replacement..... 7-18
 Preamp Board Calibration 7-20
 Pump Replacement 7-20
 Pressure Transducer Replacement 7-21
 Pressure Transducer Calibration..... 7-22
 Flow Transducer Replacement 7-24
 Flow Transducer Calibration 7-25
 Capillary Cleaning or Replacement 7-26
 Optional Zero/Span and Sample Solenoid Valve Replacement..... 7-27
 Analog Output Testing..... 7-28
 Analog Output Calibration 7-30
 Analog Input Calibration 7-31
 Calibrating the Input Channels to Zero Volts 7-31
 Calibrating the Input Channels to Full-Scale 7-32
 Ambient Temperature Calibration 7-33
 I/O Expansion Board (Optional) Replacement 7-34
 Internal O₂ Sensor (Optional) Replacement..... 7-36
 Digital Output Board Replacement 7-36
 Motherboard Replacement..... 7-37
 Measurement Interface Board Replacement 7-38
 Front Panel Board Replacement..... 7-39
 LCD Module Replacement 7-40
 Service Locations..... 7-41

Chapter 8 System Description 8-1
 Hardware 8-1
 Optical Bench..... 8-2
 Band-pass Filter 8-2
 Bench Heater Board..... 8-2
 Chopper Motor..... 8-2
 Optical Pickup..... 8-3
 Gas Filter Wheel 8-3
 Infrared Source 8-3

Pre-amplifier Assembly with IR Detector	8-3
Sample Flow Sensor	8-3
Pressure Transducer	8-3
Capillary	8-3
Pump	8-3
Purge Flow Switch (optional)	8-3
Firmware	8-3
Instrument Control	8-4
Monitoring Signals	8-4
Output Communication	8-4
Electronics	8-5
Motherboard	8-5
Measurement Interface Board	8-6
Measurement Interface Board Connectors	8-6
Flow Sensor Assembly	8-6
Pressure Sensor Assembly	8-6
Bench Heater Board	8-7
Pre-amp Board Assembly	8-7
Digital Output Board	8-7
I/O Expansion Board (Optional)	8-7
Front Panel Connector Board	8-7
I/O Components	8-8
Analog Voltage Outputs	8-8
Analog Current Outputs (Optional)	8-8
Analog Voltage Inputs (Optional)	8-9
Digital Relay Outputs	8-9
Digital Inputs	8-9
Serial Ports	8-10
RS-232 Connection	8-10
RS-485 Connection	8-11
Ethernet Connection	8-11
External Accessory Connector	8-11

Chapter 9	Optional Equipment	9-1
	Internal Zero/Span Assembly	9-1
	Internal Oxygen (O ₂) Sensor	9-1
	Internal O ₂ Sensor Calibration	9-2
	Alternate Sensor Calibration	9-3
	Internal Zero Air Scrubber	9-4
	Filter Wheel Purge	9-4
	Calibration Note	9-5
	Teflon Particulate Filter	9-5
	I/O Expansion Board Assembly	9-5
	25-Pin Terminal Board Assembly	9-5
	Terminal Block and Cable Kits	9-5
	Cables	9-6

	Mounting Options.....	9-7
Appendix A	Warranty.....	A-1
Appendix B	C-Link Protocol Commands.....	B-1
	Instrument Identification Number.....	B-1
	Commands.....	B-2
	Entering Units in PPB.....	B-3
	Convert Concentration Formats.....	B-3
	Commands List.....	B-3
	Measurements.....	B-10
	Alarms.....	B-14
	Diagnostics.....	B-18
	Datalogging.....	B-19
	Calibration.....	B-26
	Keys/Display.....	B-33
	Measurement Configuration.....	B-35
	Hardware Configuration.....	B-38
	Communications Configuration.....	B-40
	I/O Configuration.....	B-48
	Record Layout Definition.....	B-53
	Format Specifier for ASCII Responses.....	B-54
	Format Specifier for Binary Responses.....	B-54
	Format Specifier for Erec Layout.....	B-54
	Text.....	B-55
	Value String.....	B-55
	Value Source.....	B-55
	Alarm Information.....	B-55
	Translation Table.....	B-56
	Selection Table.....	B-56
	Button Designator.....	B-56
	Examples.....	B-57
Appendix C	MODBUS Protocol.....	C-1
	Serial Communication Parameters.....	C-1
	TCP Communication Parameters.....	C-2
	Application Data Unit Definition.....	C-2
	Slave Address.....	C-2
	MBAP Header.....	C-2
	Function Code.....	C-3
	Data.....	C-3
	Error Check.....	C-3
	Function Codes.....	C-3
	(0x01/0x02) Read Coils/Read Inputs.....	C-3
	(0x03/0x04) Read Holding Registers/Read Input Registers.....	C-5

(0x05) Force (Write) Single Coil C-7
MODBUS Parameters Supported C-8
Reading a Write Coil C-12

Appendix D **Gesytec (Bayern-Hessen) Protocol D-1**
Serial Communication Parameters D-1
TCP Communication Parameters D-2
Instrument Address D-2
Abbreviations Used D-2
Basic Command Structure D-2
Block Checksum Characters <BCC> D-3
Gesytec Commands D-3
 Instrument Control Command (ST) D-3
 Data Sampling/Data Query Command (DA) D-4
 Measurements reported in response to DA command D-7
 Single Range Mode D-7
 Dual/Auto Range Mode D-7
 Operating and Error Status D-7

Figures

Figure 1–1. Model 48i Flow Schematic	1-3
Figure 2–1. Remove the Packing Material	2-2
Figure 2–2. Removing the Shipping Screws	2-2
Figure 2–3. Model 48i Rear Panel.....	2-4
Figure 2–4. Atmospheric Dump Bypass Plumbing	2-4
Figure 2–5. I/O Terminal Board Views	2-6
Figure 2–6. D/O Terminal Board Views.....	2-7
Figure 2–7. 25-Pin Terminal Board Views.....	2-8
Figure 3–1. Front Panel Display.....	3-2
Figure 3–2. Front Panel Pushbuttons.....	3-2
Figure 3–3. Flowchart of Menu-Driven Firmware	3-5
Figure 3–4. Pin-Out of Rear Panel Connector in Single Range Mode	3-9
Figure 3–5. Pin-Out of Rear Panel Connector in Dual Range Mode	3-10
Figure 3–6. Analog Output in Auto Range Mode.....	3-12
Figure 3–7. Pin-Out of Rear Connector in Auto Range Mode	3-12
Figure 4–1. Calibration Flow Schematic	4-4
Figure 5–1. Inspecting and Cleaning the Fan.....	5-4
Figure 5–2. Rebuilding the Pump (New Technology).....	5-7
Figure 5–3. Rebuilding the Pump.....	5-9
Figure 6–1. Board-Level Connection Diagram - Common Electronics.....	6-5
Figure 6–2. Board-Level Connection Diagram - Measurement System	6-6
Figure 7–1. Properly Grounded Antistatic Wrist Strap	7-4
Figure 7–2. Component Layout.....	7-7
Figure 7–3. Removing the Measurement Case Assembly and Lowering the Partition Panel	7-8
Figure 7–4. Replacing the Fan	7-11
Figure 7–5. Replacing the IR Source	7-12
Figure 7–6. Removing the Motor.....	7-13
Figure 7–7. Replacing the Optical Bench	7-16
Figure 7–8. Replacing the Optical Switch (Inverted View).....	7-17
Figure 7–9. Replacing the Detector/Preamplifier Assembly	7-19
Figure 7–10. Replacing the Pump.....	7-21
Figure 7–11. Replacing the Pressure Transducer.....	7-22
Figure 7–12. Replacing the Flow Transducer.....	7-25
Figure 7–13. Cleaning or Replacing the Capillary.....	7-27
Figure 7–14. Rear Panel Analog Input and Output Pins.....	7-29

Figures

Figure 7–15. Replacing the I/O Expansion Board (Optional)	7-35
Figure 7–16. Rear Panel Board Connectors	7-35
Figure 7–17. Replacing the Measurement Interface Board	7-39
Figure 7–18. Replacing the Front Panel Board and the LCD Module.....	7-40
Figure 8–1. Hardware Components	8-2
Figure 9–1. Flow Diagram, Internal O ₂ Sensor	9-2
Figure 9–2. Purge Housing Assembly	9-4
Figure 9–3. Rack Mount Option Assembly	9-8
Figure 9–4. Bench Mounting	9-9
Figure 9–5. EIA Rack Mounting	9-10
Figure 9–6. Retrofit Rack Mounting.....	9-11
Figure B–1. Flags Field.....	B-13

Tables

Table 1–1. Model 48 <i>i</i> Specifications	1-3
Table 1–2. Model 48 <i>i</i> Optional Internal Oxygen Sensor Specifications	1-4
Table 2–1. I/O Terminal Board Pin Descriptions	2-6
Table 2–2. D/O Terminal Board Pin Descriptions.....	2-7
Table 2–3. 25-Pin Terminal Board Pin Descriptions.....	2-8
Table 3–1. Front Panel Pushbuttons	3-3
Table 3–2. Default Analog Outputs in Single Range Mode.....	3-9
Table 3–3. Default Analog Outputs in Dual Range Mode	3-11
Table 3–4. Default Analog Outputs in Auto Range Mode	3-13
Table 3–5. Available Operating Ranges	3-14
Table 3–6. Analog Output Zero to Full-Scale Table	3-52
Table 3–7. Signal Type Group Choices.....	3-53
Table 6–1. Troubleshooting - General Guide	6-2
Table 6–2. Troubleshooting - Alarm Messages	6-3
Table 6–3. Motherboard Connector Pin Descriptions.....	6-7
Table 6–4. Measurement Interface Board Connector Pin Descriptions	6-12
Table 6–5. Front Panel Board Connector Pin Diagram.....	6-14
Table 6–6. I/O Expansion Board (Optional) Connector Pin Descriptions	6-16
Table 6–7. Digital Output Board Connector Pin Descriptions.....	6-17
Table 6–8. Pre-amp Board Connector Pin Descriptions	6-19
Table 7–1. Model 48 <i>i</i> Replacement Parts.....	7-4
Table 7–2. Model 48 <i>i</i> Cables.....	7-6
Table 7–3. External Device Connection Components	7-6
Table 7–4. Analog Output Channels and Rear Panel Pin Connections.....	7-30
Table 7–5. Analog Input Channels and Rear Panel Pin Connections.....	7-30
Table 8–1. RS-232 DB9 Connector Pin Configuration	8-10
Table 8–2. RS-485 DB9 Connector Pin Configuration	8-11
Table 9–1. Cable Options.....	9-6
Table 9–2. Color Codes for 25-Pin and 37-Pin Cables	9-6
Table 9–3. Mounting Options	9-7
Table B–1. Command Response Error Descriptions	B-3
Table B–2. C-Link Protocol Commands	B-3
Table B–3. Averaging Times	B-10
Table B–4. Alarm Trigger Values	B-18
Table B–5. Record Output Formats	B-23

Tables

Table B–6. Stream Time Values	B-26
Table B–7. Standard Ranges	B-35
Table B–8. Contrast Levels	B-39
Table B–9. Reply Termination Formats	B-44
Table B–10. Allow Mode Command Values	B-46
Table B–11. Power Up Mode Values.....	B-47
Table B–12. Set Layout Ack Values.....	B-47
Table B–13. Analog Current Output Range Values.....	B-48
Table B–14. Analog Voltage Output Range Values	B-49
Table B–15. Default Analog Output Channel Assignments.....	B-51
Table C–1. Read Coils for 48 <i>i</i>	C-8
Table C–2. Read Registers for 48 <i>i</i>	C-10
Table C–3. Write Coils for 48 <i>i</i>	C-12
Table D–1. Operating Status for Model 48 <i>i</i>	D-7
Table D–2. Error Status for Model 48 <i>i</i>	D-8

Chapter 1

Introduction

The Model 48*i* CO Analyzer measures CO concentration using Gas Filter Correlation (GFC). The Model 48*i* combines proven detection technology, easy to use menu-driven firmware, and advanced diagnostics to offer unsurpassed flexibility and reliability. The Model 48*i* has the following features:

- 320 x 240 graphics display
- Menu-driven firmware
- Field programmable ranges
- User-selectable single/dual/auto range modes
- Multiple user-defined analog outputs
- Analog input options
- High sensitivity
- Fast response time
- Linearity through all ranges
- Highly specific to CO
- Self-aligning optics
- Automatic temperature and pressure compensation
- User-selectable digital input/output capabilities
- Standard communications features include RS232/485 and Ethernet
- C-Link, MODBUS, Gesytec (Bayern-Hessen), streaming data, and NTP (Network Time Protocol) protocols. Simultaneous connections from different locations over Ethernet.

For details of the analyzer's principle of operation and product specifications, see the following topics:

- [“Principle of Operation”](#) on page 1-2
- [“Specifications”](#) on page 1-3

Thermo Fisher Scientific is pleased to supply this CO analyzer. We are committed to the manufacture of instruments exhibiting high standards of quality, performance, and workmanship. Service personnel are available for assistance with any questions or problems that may arise in the use of this analyzer. For more information on servicing, see the “[Servicing](#)” chapter starting on page 7-1.

Principle of Operation

The Model 48*i* operates on the principle that carbon monoxide (CO) absorbs infrared radiation at a wavelength of 4.6 microns. Because infrared absorption is a non-linear measurement technique, it is necessary to transform the basic analyzer signal into a linear output. The Model 48*i* uses an internally stored calibration curve to accurately linearize the instrument output over any range up to a concentration of 10,000 ppm.

The sample is drawn into the Model 48*i* through the *sample* bulkhead, as shown in [Figure 1–1](#). The sample flows through the optical bench. Radiation from an infrared source is chopped and then passed through a gas filter alternating between CO and N₂. The radiation then passes through a narrow bandpass interference filter and enters the optical bench where absorption by the sample gas occurs. The infrared radiation then exits the optical bench and falls on an infrared detector.

The CO gas filter acts to produce a reference beam, which cannot be further attenuated by CO in the sample cell. The N₂ side of the filter wheel is transparent to the infrared radiation and therefore produces a measurement beam, which can be absorbed by CO in the cell. The chopped detector signal is modulated by the alternation between the two gas filters with an amplitude related to the concentration of CO in the sample cell. Other gases do not cause modulation of the detector signal since they absorb the reference and measure beams equally. Thus, the GFC system responds specifically to CO.

The Model 48*i* outputs the CO concentration to the front panel display, the analog outputs, and also makes the data available over the serial or Ethernet connection.

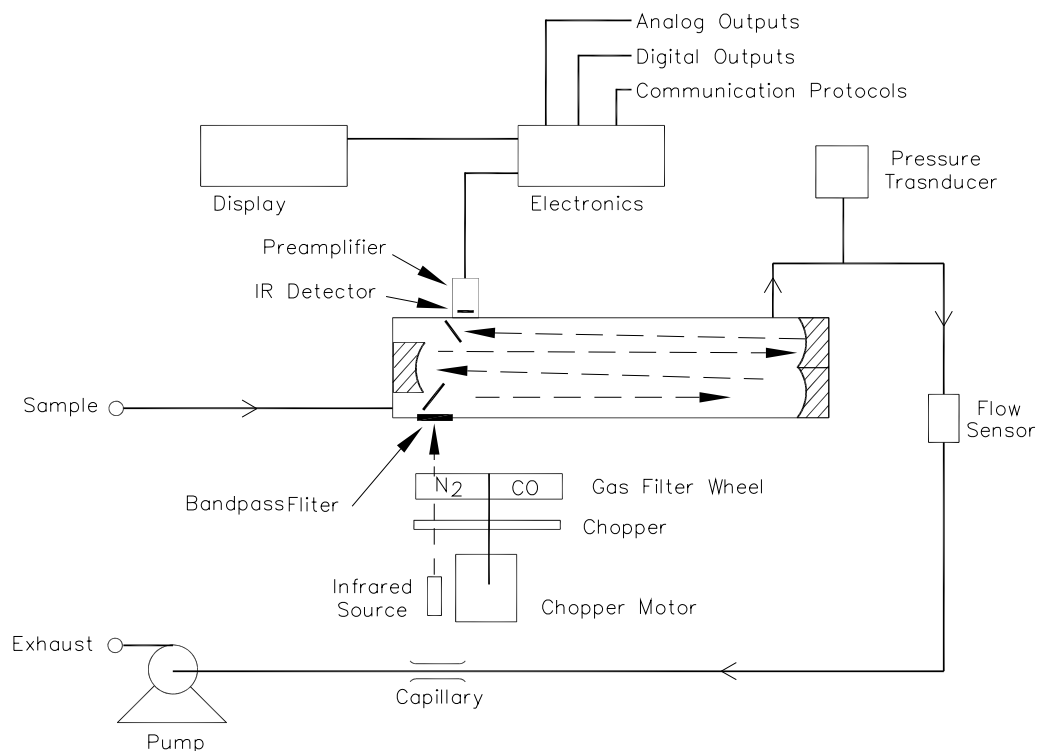

Figure 1-1. Model 48i Flow Schematic

Specifications

Table 1-1 lists the specifications for the Model 48i.

Table 1-1. Model 48i Specifications

Preset ranges	0-1, 2, 5, 10, 20, 50, 100, 200, 500, 1000, 2000, 5000, 10000 (ppm or mg/m ³)
Custom ranges	0-1 to 10000 (ppm or mg/m ³)
Zero noise	0.02 ppm RMS (30 second averaging time)
Lower detectable limit	0.04 ppm
Zero drift (24 hour)	<0.1 ppm
Span drift	±1% full-scale
Response time	60 seconds (30 second averaging time)
Linearity	±1% full-scale ≤ 1000 ppm ±2.5% full-scale > 1000 ppm
Sample flow rate	1.0 L/min

Operating temperature	20–30 °C (may be safely operated over the range of 0–45 °C)*
Power requirements	100 VAC @ 50/60 Hz 115 VAC @ 50/60 Hz 220–240 VAC @ 50/60 Hz 275 watts
Physical dimensions	16.75" (W) X 8.62" (H) X 23" (D)
Weight	Approximately 49 lbs.
Analog outputs	6 voltage outputs; 0–100 mV, 1, 5, 10 V (user selectable), 5% of full-scale over/under range (user selectable), 12 bit resolution, measurement output user selectable per channel
Digital outputs	1 power fail relay Form C, 10 digital relays Form A, user selectable alarm output, relay logic, 100 mA @ 200 VDC
Digital inputs	16 digital inputs, user select programmable, TTL level, pulled high
Serial Ports	1 RS-232 or RS-485 with two connectors, baud rate 1200–115200, data bits, parity, and stop bits, protocols: C-Link, MODBUS, Gesytec (Bayern-Hessen), and streaming data (all user selectable)
Ethernet connection	RJ45 connector for 10Mbps Ethernet connection, static or dynamic TCP/IP addressing

*In non-condensing environments. Performance specifications based on operation with 20–30 °C range.

Table 1–2. Model 48i Optional Internal Oxygen Sensor Specifications

Technology	Paramagnetic (Pm)
Range	0-100% O ₂
Accuracy (Intrinsic error)	<±0.1% O ₂
Linearity	<±0.1% O ₂
Repeatability	<±0.1% O ₂
Zero Drift	<±0.2% O ₂ per month (excludes up to 0.1% O ₂ in the first 24 hours of operation)
Response Time (T ₁₀ -T ₉₀)	<2.5 seconds
Weight	Approximately 2 lbs. (in addition to standard instrument)

Chapter 2

Installation

Installation of the Model 48*i* includes lifting the instrument, unpacking and inspection, connecting sample, zero, span, and exhaust lines, and attaching the analog and/or digital outputs to a recording device. The installation should always be followed by instrument calibration as described in the “[Calibration](#)” chapter of this manual.

Installing the Model 48*i* includes the following recommendations and procedures:

- “[Lifting](#)” on page 2-1
- “[Unpacking and Inspection](#)” on page 2-1
- “[Setup Procedure](#)” on page 2-3
- “[Connecting External Devices](#)” on page 2-5
- “[Startup](#)” on page 2-9

Lifting

When lifting the instrument, use procedure appropriate to lifting a heavy object, such as bending at the knees while keeping your back straight and upright. Grasp the instrument at the bottom in the front and at the rear of the unit. Although one person can lift the unit, it is desirable to have two persons lifting, one by grasping the bottom in the front and the other by grasping the bottom in the rear.



Equipment Damage Do not attempt to lift the instrument by the cover or other external fittings. ▲

Unpacking and Inspection

The Model 48*i* is shipped complete in one container. If there is obvious damage to the shipping container when you receive the instrument, notify the carrier immediately and hold for inspection. The carrier is responsible for any damage incurred during shipment.

Use the following procedure to unpack and inspect the instrument.

1. Remove the instrument from the shipping container and set it on a table or bench that allows easy access to both the front and rear.

Installation

Unpacking and Inspection

2. Remove the cover to expose the internal components.
3. Remove the packing material (Figure 2–1).

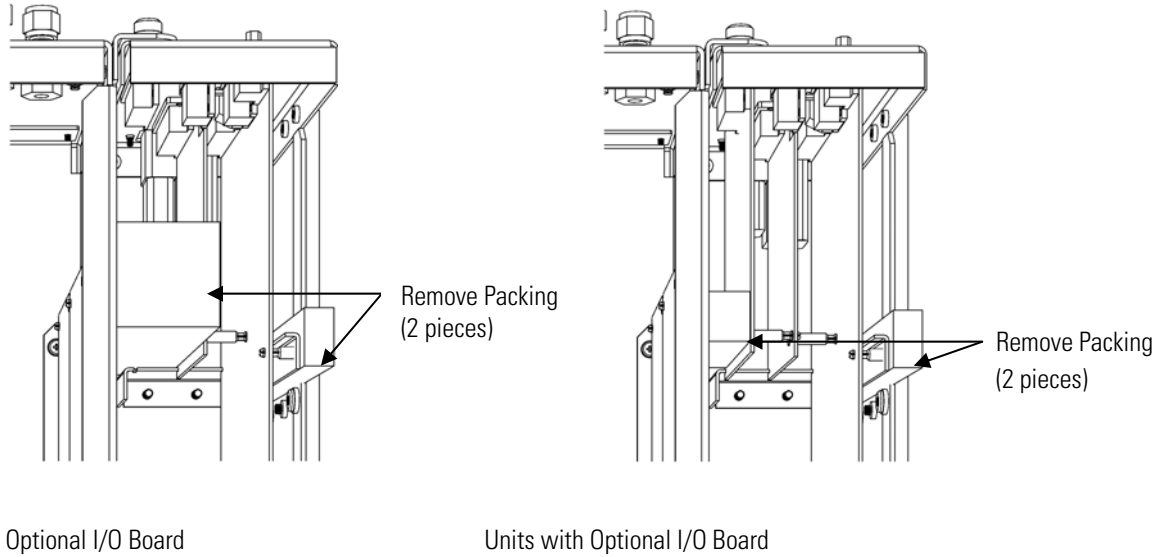

Figure 2–1. Remove the Packing Material

4. Remove the three shipping screws (Figure 2–2).

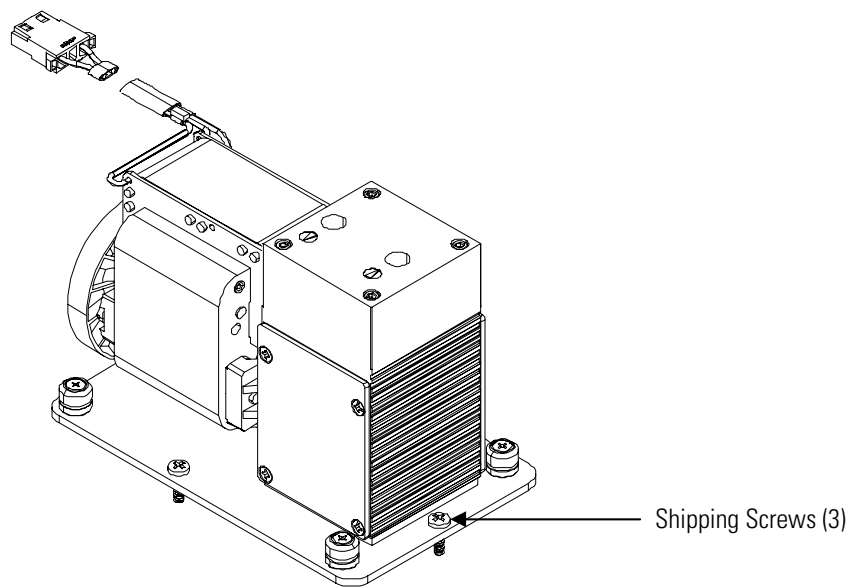

Figure 2–2. Removing the Shipping Screws

5. Check for possible damage during shipment.
6. Check that all connectors and circuit boards are firmly attached.
7. Re-install the cover.
8. Remove any protective plastic material from the case exterior.

Setup Procedure

Use the following procedure to setup the instrument:

1. Connect the sample line to the SAMPLE bulkhead on the rear panel (Figure 2–3). Ensure that the sample line is not contaminated by dirty, wet, or incompatible materials. All tubing should be constructed of Teflon®, 316 stainless steel, borosilicate glass, or similar tubing with an OD of 1/4-inch and a minimum ID of 1/8-inch. The length of the tubing should be less than 10 feet.

Note Gas must be delivered to the instrument free of particulates. It may be necessary to use the Teflon particulate filter as described in “Teflon Particulate Filter” on page 9-5. ▲

Note Gas must be delivered to the instrument at atmospheric pressure. It may be necessary to use an atmospheric bypass plumbing arrangement as shown in Figure 2–4 if gas pressure is greater than atmospheric pressure. ▲

2. Connect the EXHAUST bulkhead to a suitable vent. The exhaust line should be 1/4-inch OD with a minimum ID of 1/8-inch. The length of the exhaust line should be less than 10 feet. Verify that there is no restriction in this line.
3. If the optional zero/span solenoid valves are installed, connect a source of CO-free air to the ZERO bulkhead, and connect a source of CO span gas to the SPAN bulkhead.
4. Connect a suitable recording device to the rear panel connector. For detailed information about connecting to the instrument, refer to:
 - “Connecting External Devices” on page 2-5
 - Instrument Controls > “I/O Configuration” on page 3-45
 - “External Device Connection Components” on page 7-6

“Terminal Block and Cable Kits” on page 9-5

For detailed information about troubleshooting a connection, refer to “Analog Output Testing” on page 7-28.

5. Plug the instrument into an outlet of the appropriate voltage and frequency.



WARNING The Model 48*i* is supplied with a three-wire grounding cord. Under no circumstances should this grounding system be defeated. ▲

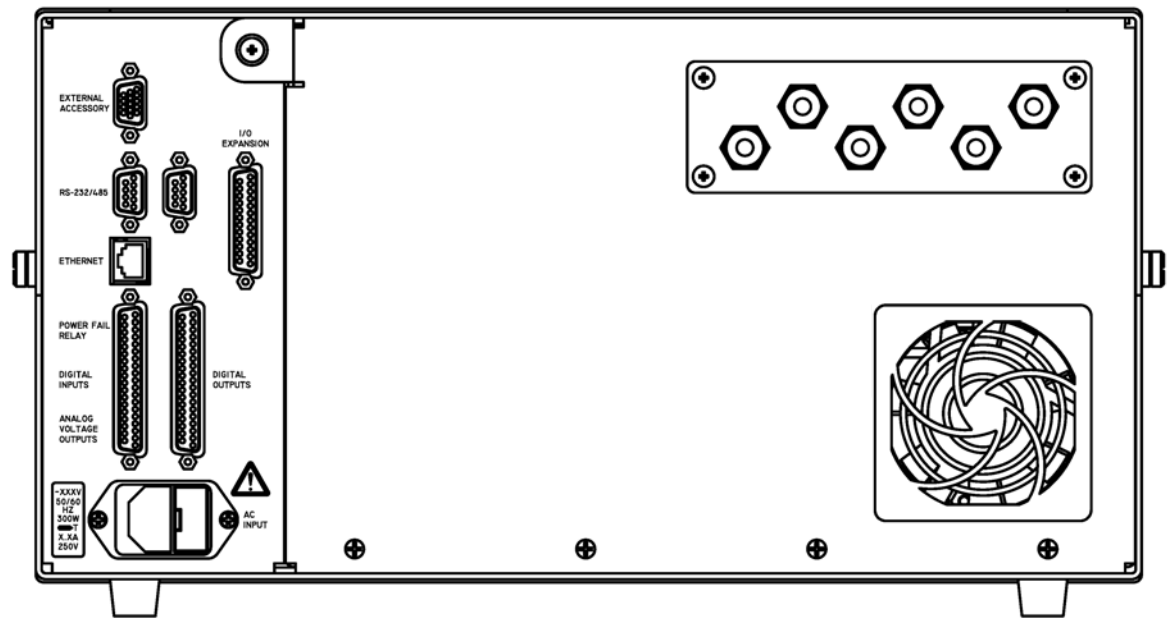

Figure 2–3. Model 48*i* Rear Panel

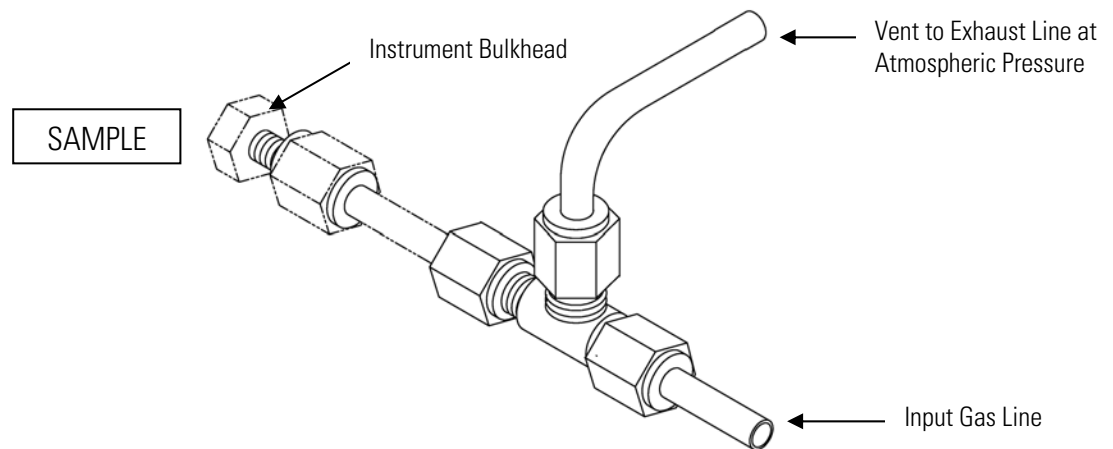

Figure 2–4. Atmospheric Dump Bypass Plumbing

Connecting External Devices

Several components are available for connecting external devices to *iSeries* instruments.

These connection options include:

- Individual terminal board PCB assemblies
- Terminal block and cable kits (optional)
- Individual cables (optional)

For detailed information on the optional connection components, refer to the “[Optional Equipment](#)” chapter. For associated part numbers, refer to “[External Device Connection Components](#)” on page 7-6.

Terminal Board PCB Assemblies

The terminal board PCB assemblies are circuit boards with a D-Sub connector on one side and a series of screw terminals on the other side. This assembly provide a convenient mechanism for connecting wires from a data system to the analyzer’s I/O connectors.

The following terminal board PCB assemblies are available for *iSeries* instruments:

- I/O terminal board PCB assembly, 37 pin (standard)
- D/O terminal board PCB assembly, 37 pin (standard)
- 25-pin terminal board PCB assembly, (included with optional I/O Expansion Board)

I/O Terminal Board

[Figure 2–5](#) shows the recommended method for attaching the cable to the terminal board using the included tie-down and spacer. [Table 2–1](#) identifies the connector pins and associated signals.

Note Not all of the I/O available in the instrument is brought out on the supplied terminal board. If more I/O is desired, an alternative means of connection is required. See optional “[Terminal Block and Cable Kits](#)”. ▲

Installation

Connecting External Devices

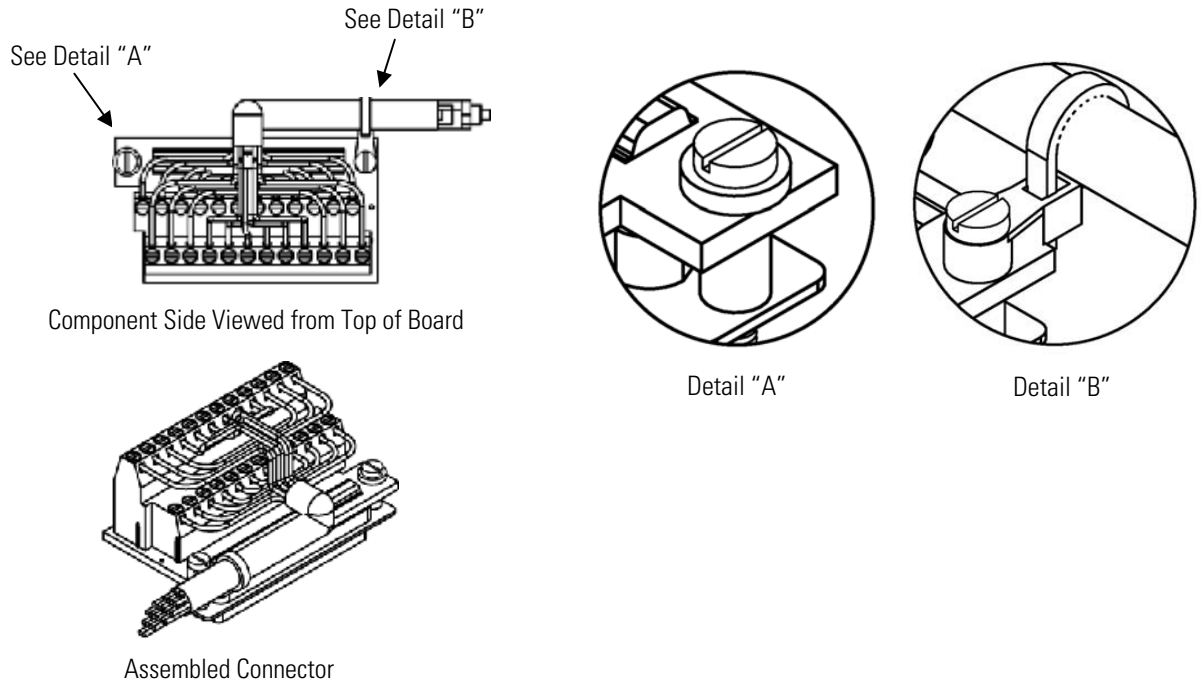

Figure 2–5. I/O Terminal Board Views

Table 2–1. I/O Terminal Board Pin Descriptions

Screw	Signal Description	Screw	Signal Description
1	Analog1	13	Power_Fail_NC
2	Analog ground	14	Power_Fail_COM
3	Analog2	15	Power_Fail_NO
4	Analog ground	16	TTL_Input1
5	Analog3	17	TTL_Input2
6	Analog ground	18	TTL_Input3
7	Analog4	19	TTL_Input4
8	Analog ground	20	Digital ground
9	Analog5	21	TTL_Input5
10	Analog ground	22	TTL_Input6
11	Analog6	23	TTL_Input7
12	Analog ground	24	Digital ground

D/O Terminal Board Figure 2–6 shows the recommended method for attaching the cable to the terminal board using the included tie-down and spacer. Table 2–2 identifies the connector pins and associated signals.

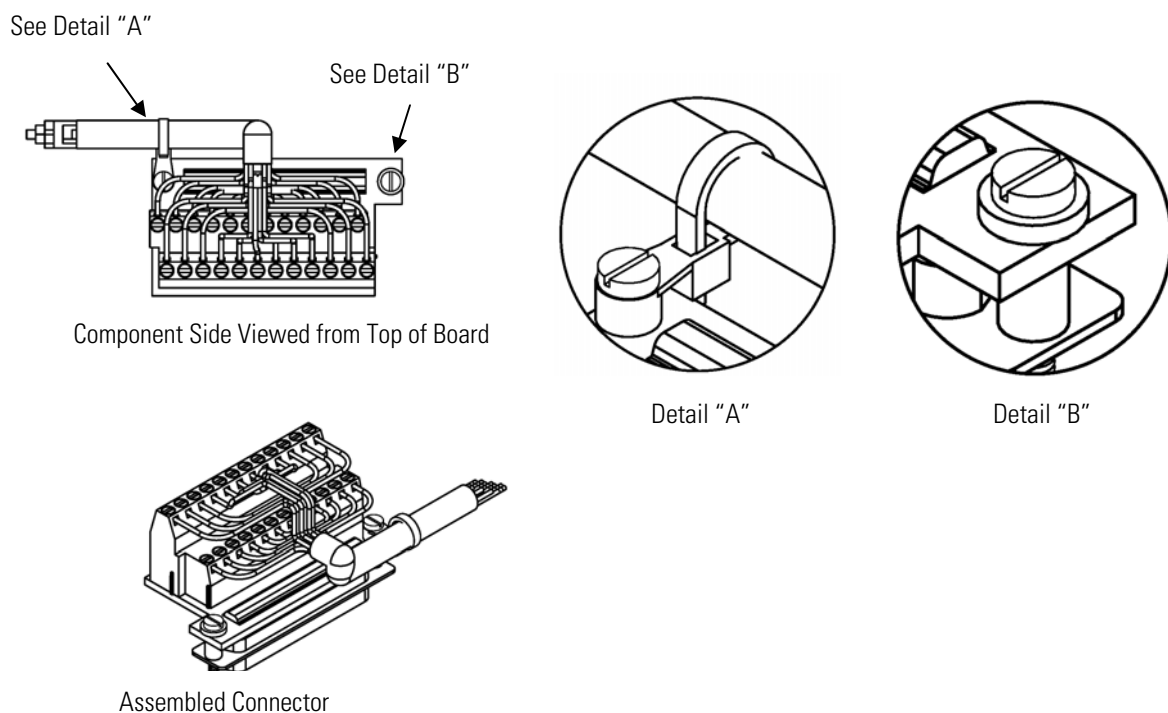

Figure 2–6. D/O Terminal Board Views

Table 2–2. D/O Terminal Board Pin Descriptions

Screw	Signal Description	Screw	Signal Description
1	Relay1_ContactA	13	Relay7_ContactA
2	Relay1_ContactB	14	Relay7_ContactB
3	Relay2_ContactA	15	Relay8_ContactA
4	Relay2_ContactB	16	Relay8_ContactB
5	Relay3_ContactA	17	Relay9_ContactA
6	Relay3_ContactB	18	Relay9_ContactB
7	Relay4_ContactA	19	Relay10_ContactA
8	Relay4_ContactB	20	Relay10_ContactB
9	Relay5_ContactA	21	Solenoid_Drive_Output1
10	Relay5_ContactB	22	+24V
11	Relay6_ContactA	23	Solenoid_Drive_Output2
12	Relay6_ContactB	24	+24V

25-Pin Terminal Board

The 25-pin terminal board is included with the optional I/O Expansion Board.

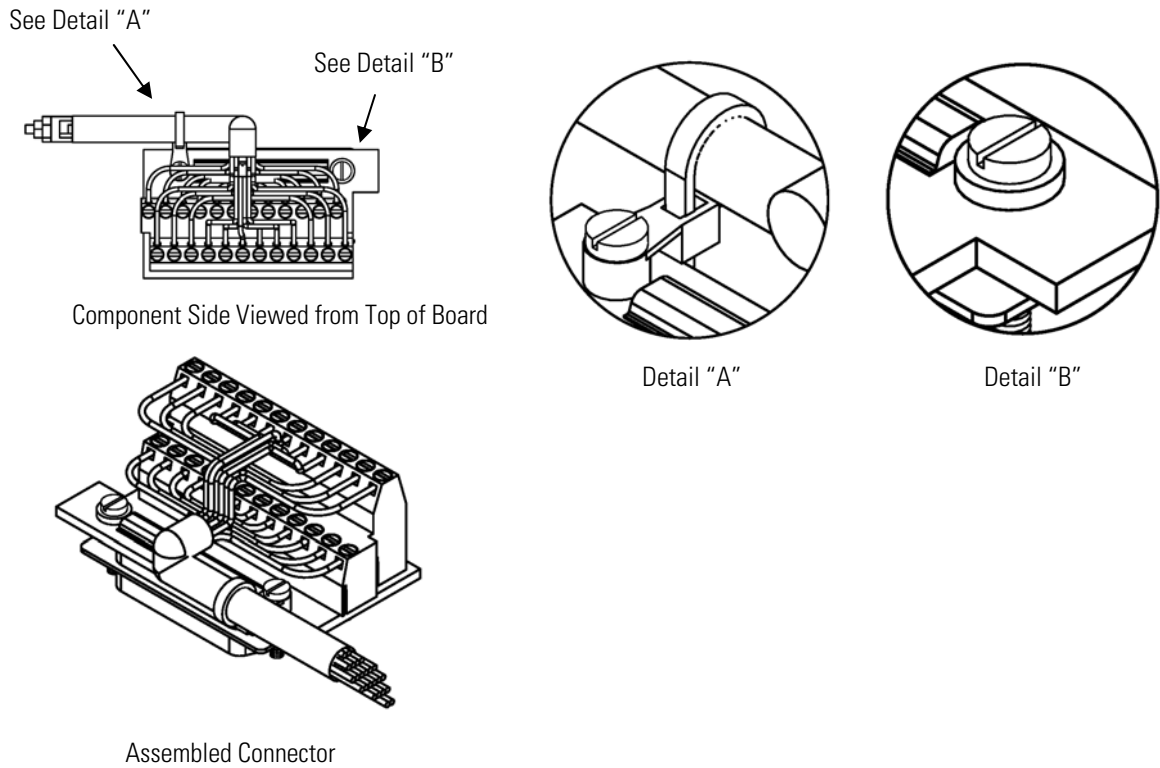

Figure 2–7. 25-Pin Terminal Board Views

Table 2–3. 25-Pin Terminal Board Pin Descriptions

Screw	Signal Description	Screw	Signal Description
1	IOut1	13	Analog_In1
2	GND_ISO	14	Analog_In2
3	IOut2	15	Analog_In3
4	GND_ISO	16	GNDD
5	IOut3	17	Analog_In4
6	GND_ISO	18	Analog_In5
7	IOut4	19	Analog_In6
8	GND_ISO	20	GNDD
9	IOut5	21	Analog_In7
10	GND_ISO	22	Analog_In8
11	IOut6	23	GNDD
12	GND_ISO	24	GNDD

Startup Use the following procedure when starting the instrument.

1. Turn the power ON.
2. Allow 90 minutes for the instrument to stabilize.
3. Set instrument parameters such as operating ranges and averaging times to appropriate settings. For more information about instrument parameters, see the “[Operation](#)” chapter.
4. Before beginning the actual monitoring, perform a multipoint calibration as described in the “[Calibration](#)” chapter.



Chapter 3

Operation

This chapter describes the front panel display, front panel pushbuttons, and menu-driven firmware. For details, see the following topics:

- “Display” on page 3-1
- “Pushbuttons” on page 3-2
- “Firmware Overview” on page 3-4
- “Range Menu” on page 3-8
- “Averaging Time” on page 3-16
- “Calibration Factors Menu” on page 3-16
- “Calibration Menu” on page 3-20
- “Instrument Controls Menu” on page 3-25
- “Diagnostics Menu” on page 3-61
- “Alarms Menu” on page 3-68
- “Service Menu” on page 3-78
- “Password” on page 3-94

Display

The 320 x 240 graphics liquid-crystal display (LCD) shows the sample concentrations, instrument parameters, instrument controls, help, and error messages. Some menus contain more items than can be displayed at one time. For these menus, use  and  to move the cursor up and down to each item.

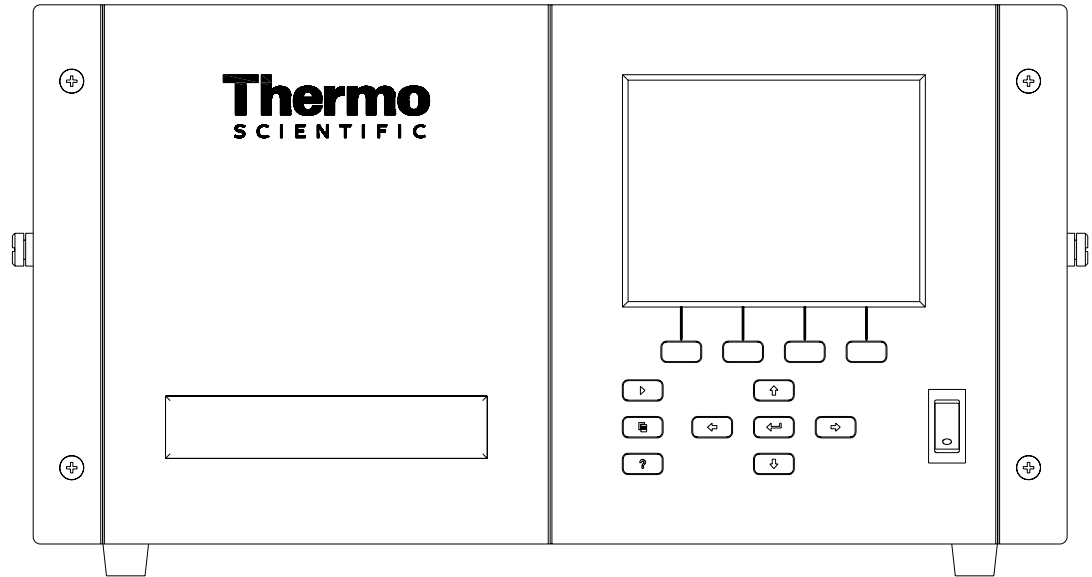

Figure 3–1. Front Panel Display



CAUTION If the LCD panel breaks, do not to let the liquid crystal contact your skin or clothes. If the liquid crystal contacts your skin or clothes, wash it off immediately using soap and water. ▲

Pushbuttons

The Pushbuttons allow the user to traverse the various screens/menus.

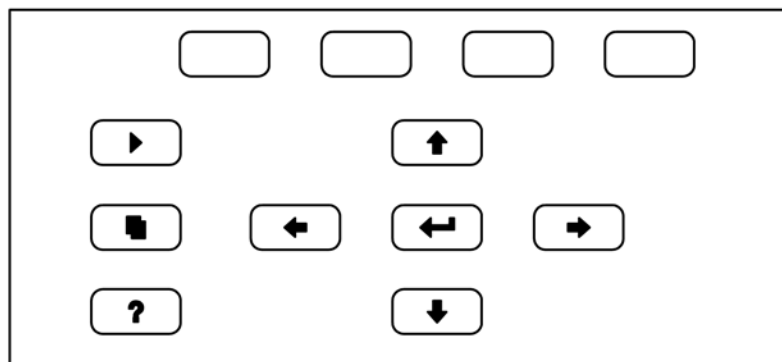





















Figure 3–2. Front Panel Pushbuttons

Table 3–1 lists the front panel pushbuttons and their functions.

Table 3–1. Front Panel Pushbuttons

Key Name	Function
 = Soft Keys	The  (soft keys) are used to provide shortcuts that allow the user to jump to user-selectable menu screens. For more information on processing soft keys, see “Soft Keys” below
 = Run	The  is used to display the Run screen. The Run screen normally displays the CO concentration.
 = Menu	The  is used to display the Main Menu when in the Run screen, or back up one level in the menu system. For more information about the Main Menu, see “Main Menu” later in this chapter.
 = Help	The  is context-sensitive, that is, it provides additional information about the screen that is being displayed. Press  for a brief explanation about the current screen or menu. Help messages are displayed using lower case letters to easily distinguish them from the operating screens. Press  to return to the Run screen, or any other key to exit a help screen.
  = Up, Down   = Left, Right	The four arrow pushbuttons ( ,  ,  , and ) move the cursor up, down, left, and right or change values and states in specific screens.
 = Enter	The  is used to select a menu item, accept/set/save a change, and/or toggle on/off functions.

Soft Keys

The soft keys are multi-functional keys that use part of the display to identify their function. The function of the soft keys is to provide a shortcut to the most often used menus and screens. They are located directly underneath the display, and user-defined labels in the lower part of the display indicate the function of each key at that time.

To change a soft key, place the menu cursor “>” on the item of the selected menu or screen you wish to set. Press  followed by the selected soft key within 1 second of pressing the right-arrow key. The “edit soft key prompt” will be displayed for configuration of the new label.

Note Not all menu items may be assigned to soft keys. If a particular menu or screen item cannot be assigned, the key assignment screen will not come up upon entering right-arrow-soft key combinations. All items under the Service menu (including the menu itself) cannot be assigned soft keys. ▲



Alphanumeric Entry Screen

The alphanumeric entry screen is used to enter strings consisting of letters, numbers, and other characters. The cursor may be positioned within the entry line using the and keys. If a character is entered over an existing character, that character will be overwritten. Use the and keys to switch between the entry line and the keyboard as well as to move within the keyboard. To select a character to add to the string, use the cursor keys to position the cursor over the desired character, and then press the key to add that character to the entry line.

On the right side of the keyboard are special functions. BKSP is used to move the cursor in the entry line one place to the left, deleting the character that was to the left of the cursor and moving any character at or to the right of the cursor one place to the left. PAGE is used to change the keyboard character page. For the English language, this switches between upper and lower-case alphabetic characters. SAVE stores the string from the entry line into the parameter. Alternately, if the active cursor is moved to the entry line, may be pressed to store the string from the entry line into the parameter.

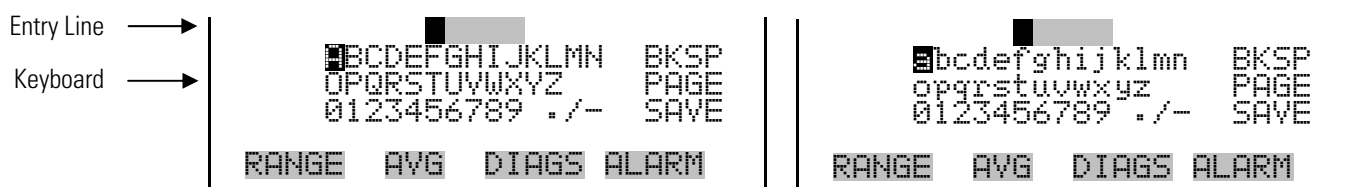

Firmware Overview

The Model 48*i* utilizes the menu-driven firmware as illustrated by the flowchart in [Figure 3–3](#). The Power-Up screen, shown at the top of the flowchart, is displayed each time the instrument is turned on. This screen is displayed while the instrument is warming up and performing self-checks. After the warm-up period, the Run screen is automatically displayed. The Run screen is the normal operating screen. It displays the CO concentration, depending on operating mode. From the Run screen, the Main Menu can be displayed by pressing . The Main Menu contains a list of submenus. Each submenu contains related instrument settings. This chapter describes each submenu and screen in detail. Refer to the appropriate sections for more information.

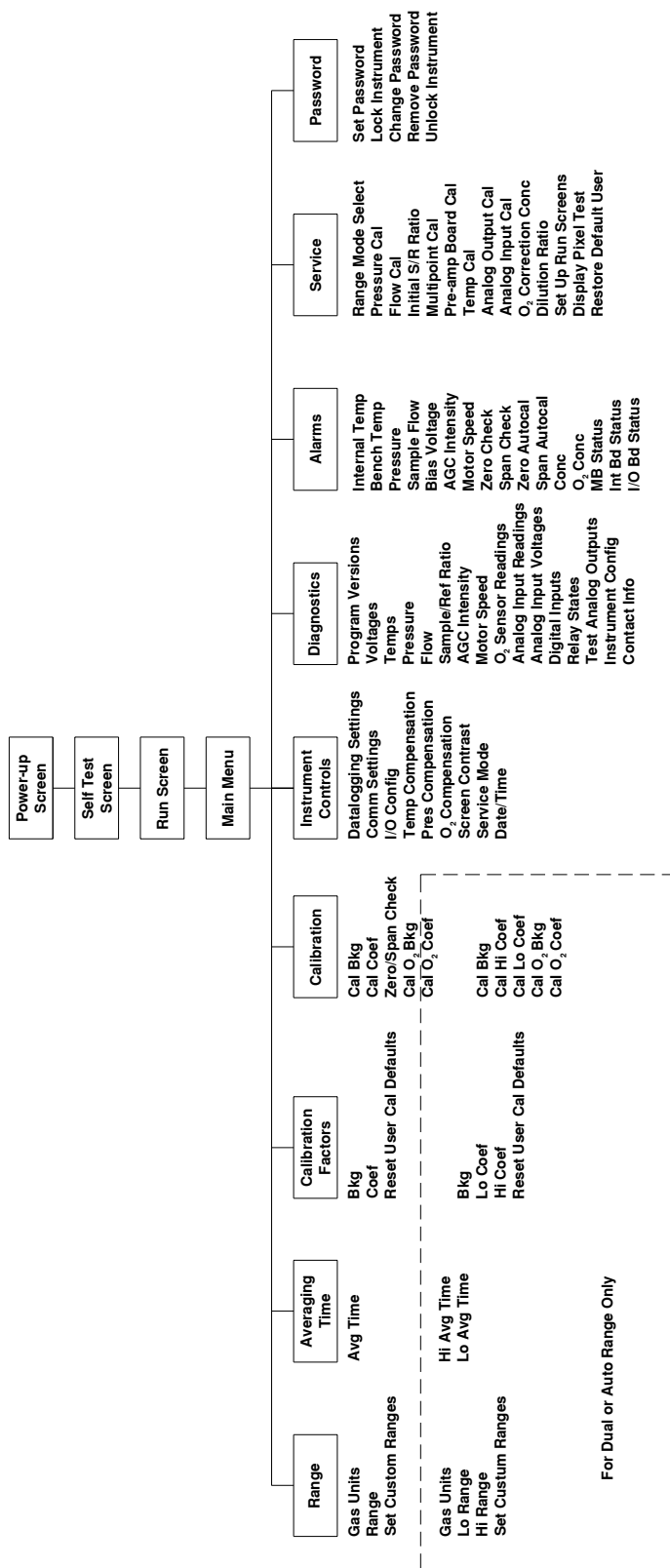

Figure 3–3. Flowchart of Menu-Driven Firmware

Power-Up Screen

The Power-Up screen is displayed on power up of the Model 48i. This screen is displayed while the internal components are warming up and diagnostic checks are performed.



Run Screen

The Run screen displays the current CO concentrations. The status bar displays the time (24-hour format), the password (lock) icon, service (wrench) icon, alarm (bell) icon, and optional zero/span sample solenoid valve status, if installed.

Status Bar Icons



The password (lock) icon indicates that no parameter changes can be made from the front panel.



The alarm (bell) icon indicates that an alarm is active.

The service (wrench) icon indicates that the instrument is in the service mode.

The word "SAMPLE" on the left of the status bar indicates the analyzer has the zero/span valve option and is in "SAMPLE" mode. Other modes appear in the same area of the display as "ZERO" or "SPAN". For more information about the optional solenoid valves, see Chapter 9, "[Optional Equipment](#)".

When operating in dual or auto range mode two sets of coefficients are used to calculate the CO “High” and “Low” concentrations. Also, two averaging times are used—one for each range. The title bar indicates which range concentrations are displayed. The words “LOW RANGE CONCENTRATION” on the top of the display indicates that the low concentration is displayed. In dual range mode, pressing the  and  arrows will toggle between high and low concentrations. The following example shows the Run screen in single range mode.

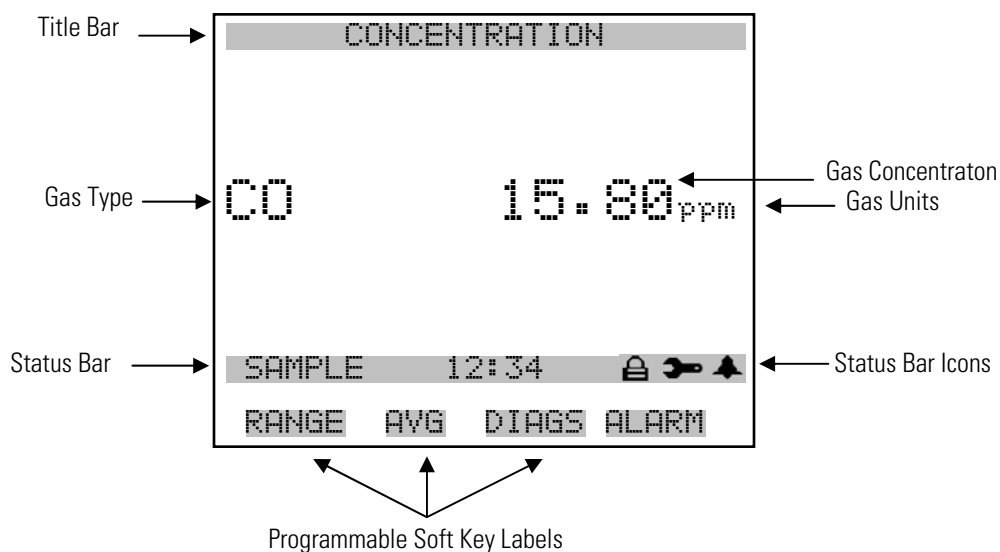



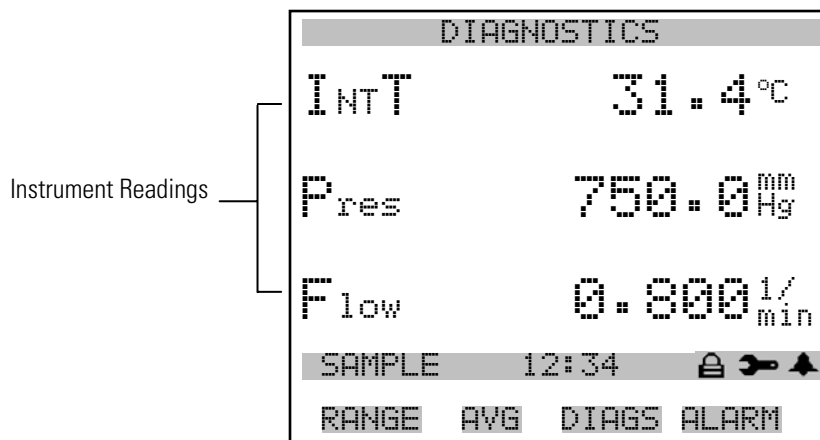

Custom Run Screens Up to five Custom Run Screens can be configured. For more information on custom run screens, see “[Setup Run Screens](#)” on page 3-89.



Main Menu

The Main Menu contains a number of submenus. Instrument parameters and settings can be read and modified within the submenus according to their function. The concentration appears above the main menu and submenus in every screen. The Service menu is visible only when the instrument is in service mode. For more information on the service mode, see “[Service Mode](#)” later in this chapter.

- Use  and  to move the cursor up and down.
- Press  to select a choice.
- Press  to return to the Main Menu or  to return to the Run screen.

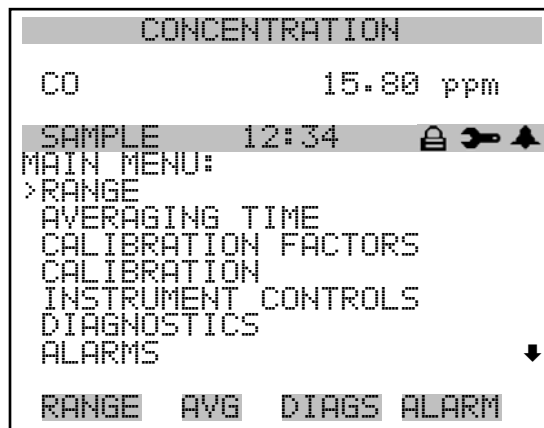

SERVICE
PASSWORD

Range Menu

The Range menu allows the operator to select the gas units, CO ranges, and to set the custom ranges. The screens below show the range menu in single range mode and dual/auto range modes. The only difference between the screens are the words “HI” and “LO” to indicate which range is displayed. For more information about the single, dual and auto range modes, see “[Single Range Mode](#)”, “[Dual Range Mode](#)”, and “[Auto Range Mode](#)” below.

- In the Main Menu, choose **Range**



Single Range Mode

In the single range mode, there is one range, one averaging time, and one span coefficient.

By default, the two CO analog outputs are arranged on the rear panel connector as shown in Figure 3-4. See Table 3-2 for channels and pin connections. Single range mode may be selected from the “Range Mode Select” on page 3-78.

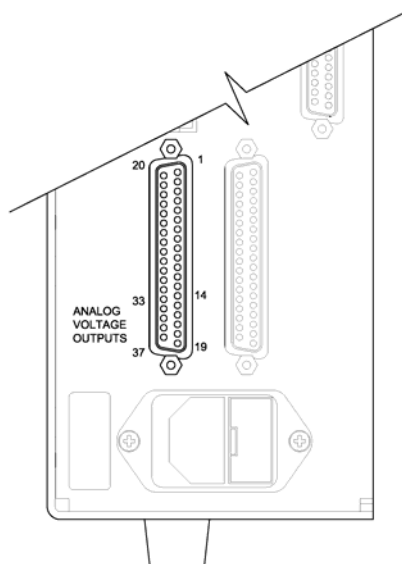

Figure 3-4. Pin-Out of Rear Panel Connector in Single Range Mode

Table 3-2. Default Analog Outputs in Single Range Mode

Channel	Connector Pin	I/O Terminal Pin	Description
1	14	1	CO Analog Output
2	33	3	CO Analog Output
3	15	5	None
4	34	7	None
5	17	9	None
6	36	11	None
Ground	16, 18, 19, 35, 37	2, 4, 6, 8, 10, 12	Signal Ground

Note All channels are user definable. If any customization has been made to the analog output configuration, the default selections may not apply. ▲

Dual Range Mode

In the dual range mode, there are two independent analog outputs. These are labeled simply as the “High Range” and the “Low Range”. Each channel has its own analog output range, averaging time, and span coefficient.

This enables the sample concentration reading to be sent to the analog outputs at two different ranges. For example, the low CO analog output can be set to output concentrations from 0 to 50 ppm and the high CO analog output set to output concentrations from 0 to 100 ppm.

In addition, each CO analog output has a span coefficient. There are two span coefficients so that each range can be calibrated separately. This is necessary if the two ranges are not close to one another. For example, the low CO range is set to 0–50 ppm and the high CO range is set to 0–10000 ppm.

By default, in the dual range mode, the analog outputs are arranged on the rear panel connector as shown in [Figure 3–5](#). See [Table 3–3](#) for channels and pin connections. Dual range mode may be selected from the “[Range Mode Select](#)” on [page 3-78](#).

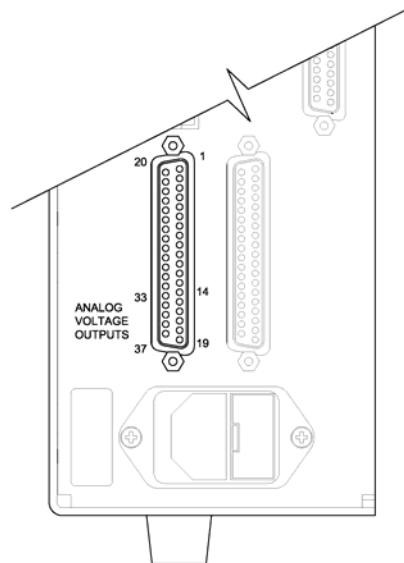

Figure 3–5. Pin-Out of Rear Panel Connector in Dual Range Mode

Table 3–3. Default Analog Outputs in Dual Range Mode

Channel	Connector Pin	I/O Terminal Pin	Description
1	14	1	CO High Range
2	33	3	CO Low Range
3	15	5	None
4	34	7	None
5	17	9	None
6	36	11	None
Ground	16, 18, 19, 35, 37	2, 4, 6, 8, 10, 12	Signal Ground

Note All channels are user definable. If any customization has been made to the analog output configuration, the default selections may not apply. ▲

Auto Range Mode

The auto range mode switches the CO analog outputs between a high and low ranges, depending on the concentration level. The high and low ranges are defined in the Range menu.

For example, suppose the low range is set to 50 ppm and the high range is set to 100 ppm (Figure 3–6). Sample concentrations below 50 ppm are output based on low range selection and sample concentrations above 50 ppm are output based on high range selection. When the low range is active, the status output is at 0 volts. When the high range is active, the status output is at half of full-scale.

When the high range is active, the concentration must drop to 95% of the low CO range for the low range to become active.

In addition, each CO analog output has a span coefficient. There are two span coefficients so that each range can be calibrated separately. This is necessary if the two ranges are not close to one another. For example, the low CO range is set to 0–50 ppm and the high CO range is set to 0–10000 ppm.

Note When using auto range mode, the high and low ranges should not vary by more than 1 order of magnitude. For instance, if the low range is set to 20 ppm, then the high range should be set to no more than 200 ppm. This is because the concentration response is non-linear and it is possible that the low range readings could become unpredictable above the top of the low range, resulting in a substantial jump in concentration readings when switching between ranges. One possible fix for this would be to perform the 3-point calibration (via the Service menu) on both ranges and make sure that the low range high point matches or is greater than the

high range low point. This will ensure that the high and low range concentration curves will overlap. If both of these methods are unacceptable due to local regulations, then the dual range mode should be used so that the range selection may be evaluated by the user to meet their regulations. ▲

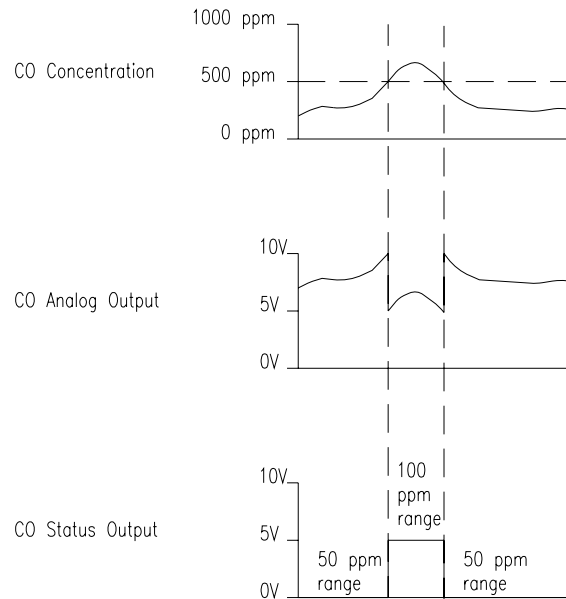

Figure 3–6. Analog Output in Auto Range Mode

By default, in the auto range mode, the analog outputs are arranged on the rear panel connector as shown in [Figure 3–7](#). See [Table 3–4](#) for channels and pin connections. Auto range mode may be selected from the “[Range Mode Select](#)” on [page 3-78](#).

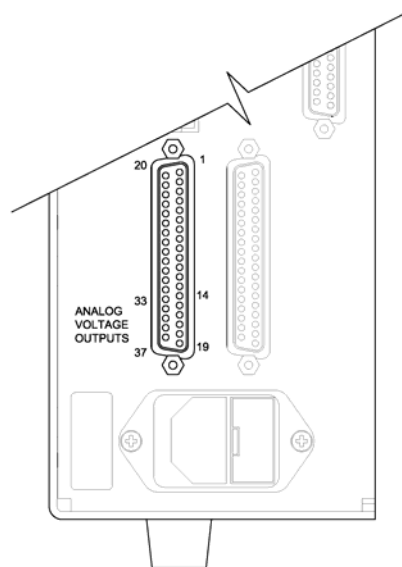

Figure 3–7. Pin-Out of Rear Connector in Auto Range Mode

Table 3–4. Default Analog Outputs in Auto Range Mode

Channel	Connector Pin	I/O Terminal Pin	Description
1	14	1	CO Analog Output
2	33	3	Range Status: half-scale = high range zero scale = low range
3	15	5	None
4	34	7	None
5	17	9	None
6	36	11	None
Ground	16, 18, 19, 35, 37	2, 4, 6, 8, 10, 12	Signal Ground

Note All channels are user definable. If any customization has been made to the analog output configuration, the default selections may not apply. ▲

Gas Units

The Gas Units screen defines how the CO concentration reading is expressed. Gas units of parts per million (ppm) and milligrams per cubic meter (mg/m^3) are available. The mg/m^3 gas concentration mode is calculated using a standard pressure of 760 mmHg and a standard temperature of 20 °C.

When switching from ppm to mg/m^3 , the analog ranges all default to the highest range in that mode. For example, when switching from mg/m^3 to ppm, all the ranges default to 10000 ppm. Therefore, whenever you change units, you should also check the range settings.

- In the Main Menu, choose Range > **Gas Units**.

Note If the units change from ppm to mg/m^3 or vice versa, the instrument should be re-calibrated, particularly if the user's standard temperature is different from 20 °C. A display warning will appear that ranges will be defaulted and calibration parameters reset. ▲

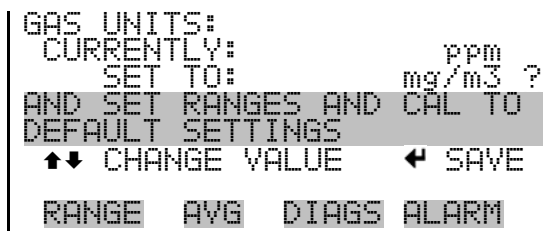

CO Range

The CO Range screen defines the concentration range of the analog outputs. For example, a CO range of 0–50 ppm restricts the analog output to concentrations between 0 and 50 ppm.

The display shows the current CO range. The next line of the display is used to change the range. The range screen is similar for the single, dual, and auto range modes. The only difference between the screens are the words “High” or “Low” displayed to indicate which range is displayed. The following example shows the CO range screen in single mode. For more information about the dual and auto range modes, see “[Single Range Mode](#)”, “[Dual Range Mode](#)”, and “[Auto Range Mode](#)” earlier in this chapter.

Table 3–5 lists the available preset ranges.

- In the Main Menu, choose Range > **Range**.

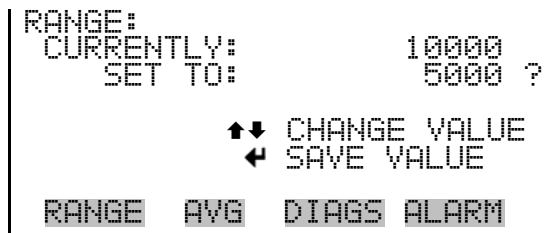

Table 3–5. Available Operating Ranges

ppm	mg/m ³
1	1
2	2
5	5
10	10
20	20
50	50
100	100
200	200
500	500
1000	1000
2000	2000
5000	5000

ppm	mg/m ³
10000	10000
C1	C1
C2	C2
C3	C3

C1, C2, and C3 are custom ranges. For more information about custom ranges, see “[Set Custom Ranges](#)” below.

Set Custom Ranges

The Set Custom Ranges menu lists three custom ranges, which are user-defined. In the ppm or mg/m³ mode, any value between 1 and 10000 mg/m³ can be specified as a range.

- In the Main Menu, choose Range > **Set Custom Ranges**.

```

CUSTOM RANGES:
>CUSTOM RANGE 1      55.0
CUSTOM RANGE 2      75.0
CUSTOM RANGE 3     125.0

RANGE  AVG  DIAGS  ALARM
  
```

Custom Ranges

The Custom Ranges screen is used to define the custom ranges.

The display shows the current custom range. The next line of the display is used to set the range. To use the custom full-scale range, be sure to select it (Custom range 1, 2, or 3) in the CO Ranges screen. For more information about selecting ranges, see “[CO Range](#)” above.

- In the Main Menu, choose Range > Set Custom Ranges > **Custom Range 1, 2, or 3**.

```

CUSTOM RANGE 1:
CURRENTLY:      55.5
SET TO:        000055.5 ?

      ←→ MOVE CURSOR
↑↓ CHANGE VALUE  ← SAVE

RANGE  AVG  DIAGS  ALARM
  
```

Averaging Time

The Averaging Time defines a time period (1 to 300 seconds) during which CO measurements are taken. The average concentration of the readings are calculated for that time period. The front panel display and analog outputs are updated every 10 seconds for averaging times between 10 and 300 seconds. For averaging times of 1, 2, and 5 seconds, the front panel display and analog outputs are updated every second. An averaging time of 10 seconds, for example, means that the average concentration of the last 10 seconds will be output at each update. An averaging time of 300 seconds means that the moving average concentration of the last 300 seconds will be output at each update. Therefore, the lower the averaging time the faster the front panel display and analog outputs respond to concentration changes. Longer averaging times are typically used to smooth output data.

The Averaging Time screen for the single range mode is shown below. In the dual and auto range modes, an Averaging Time Menu is displayed before the averaging time screens. This menu is needed because the dual and auto range modes have two averaging times (high and low). The Averaging Time screen functions the same way in the single, dual, and auto range modes. The following averaging times are available: 1, 2, 5, 10, 20, 30, 60, 90, 120, 180, 240, and 300 seconds.

- In the Main Menu, choose **Averaging Time**.

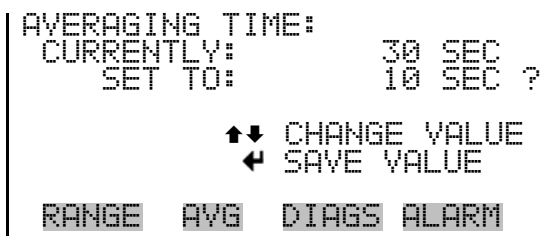

```
AVERAGING TIME:
CURRENTLY:      30 SEC
SET TO:         10 SEC ?

      ↑↓ CHANGE VALUE
      ← SAVE VALUE

RANGE  AVG  DIAGS  ALARM
```

Calibration Factors Menu

The Calibration Factors menu displays the calibration factors, which are used to correct the CO readings that the instrument generates using its own internal calibration data. The screens below show the calibration factors menu in single mode and dual/auto range modes. The only difference between the screens are the words “LO” and “HI” to indicate which range is displayed. The O₂ Background menu item and the O₂ Coefficient menu item are displayed only when the internal O₂ sensor option is installed.

Normally, the calibration factors are calculated automatically using the functions described in “[Calibration Menu](#)” later in this chapter. However, the calibration factors can also be set manually using the functions in this menu.

- In the Main Menu, choose **Calibration Factors**.

```

CALIBRATION FACTORS:
>BKG          0.0
COEF          1.000
O2 BKG        0.0
O2 COEF       1.000
RESET USER CAL DEFAULTS

RANGE  AVG  DIAGS  ALARM

```

```

CALIBRATION FACTORS:
>BKG          0.0
LO COEF       1.000
HI COEF       1.000
O2 BKG        0.0
O2 COEF       1.000

RANGE  AVG  DIAGS  ALARM

```





RESET USER CAL DEFAULTS

CO Background

The CO background correction is determined during zero calibration. The CO background is the amount of signal read by the analyzer while sampling zero air. Before the analyzer sets the CO reading to zero, it stores this value as the CO background correction.

The CO Background screen is used to perform a manual zero calibration of the instrument. As such, the instrument should sample zero air until stable readings are obtained. The first line of the display shows the current CO reading. This reading is the CO background signal. The second line of the display shows the CO background correction that is stored in memory and is being used to correct the CO reading. That is, the CO background correction is subtracted from the CO reading.

In the following example, the analyzer is reading 15.80 ppm of CO while sampling zero air. The CO background correction is 0.0 ppm. That is, the analyzer is not applying a zero background correction. The question mark is used as a prompt to change the background correction. In this case the background correction must be increased to 15.80 ppm in order for the CO reading to be at 0 ppm.

To set the CO reading in the following example to zero, use  to increment the CO background correction to 15.80 ppm. As the CO background correction is increased, the CO concentration is decreased. At this point, however, no real changes have been made. To escape this screen without making any changes, press  to return to the Calibration Factors menu or  to return to the Run screen. Press  to actually set the CO reading to 0 ppm and store the background correction of 15.80 ppm.

- In the Main Menu, choose Calibration Factors > **Bkg**.

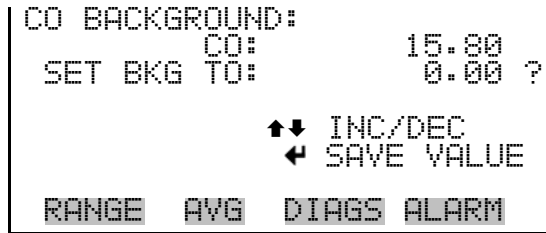

CO Coefficient

The CO span coefficient is usually calculated by the instrument processor during calibration. The span coefficients are used to correct the CO readings and normally has a value near 1.000.

The CO Coefficient screen enables the CO span coefficient to be manually changed while sampling span gas of known concentration.

The display shows the current CO concentration reading. The next line of the display shows the CO span coefficient that is stored in memory and is being used to correct the CO concentration. Notice that as the span coefficient value is changed, the current CO concentration reading above also changes. However, no real changes are made until  is pressed.

In dual or auto range modes, “HIGH” or “LOW” is displayed to indicate the calibration of the high or low coefficient. The following example shows the coefficient screen in dual/auto range mode.

Note The concentration value will show “ERROR” if the measured concentration is not a valid span value (either higher than the selected range, or 0 or lower). ▲

- In the Main Menu, choose Calibration Factors > Hi Coef.

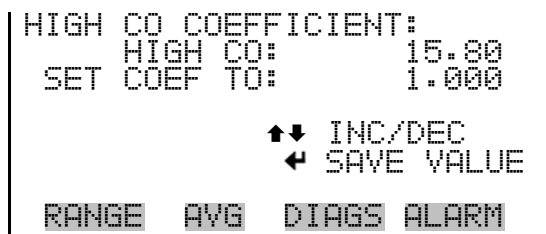







O₂ Background

The O₂ Background screen is used to perform a manual zero calibration of the oxygen sensor. Before performing a zero calibration, allow the analyzer to sample nitrogen until stable readings are obtained. The first line of the display shows the current O₂ reading. The second line of the display shows the O₂ background correction that is stored in memory. The O₂

background correction is a value, expressed in %, that is subtracted from the O₂ reading to produce the O₂ reading that is displayed.

In the example below, the analyzer displays 0.12% of O₂ while sampling nitrogen. A background correction of 0.00% means that 0% is being subtracted from the O₂ concentration being displayed. Therefore, the background correction must be increased to 0.12% in order for the O₂ reading to be at 0%, i.e., an O₂ reading of 0.12% minus an O₂ background reading of 0.12% gives the corrected O₂ reading of 0%.

To set the O₂ reading in the example below to zero, use  to increment the O₂ background correction to 0.12%. As the O₂ background correction is increased, the O₂ concentration is decreased. Note that at this point, pressing  and  however, has no affect on the analog outputs or the stored O₂ background correction of 0.00%. A question mark following both the O₂ reading and the O₂ background correction indicates that these are proposed changes as opposed to implemented changes. To escape this screen without saving any changes, press  to return to the Calibration Factors menu or  to return to the Run screen. Press  to actually set the O₂ reading to 0.00% and store the new background correction of 0.12%. Then the question mark prompt beside the O₂ reading disappears.

- In the Main Menu, choose Calibration Factors > **O₂ Background**.

```



O2 BACKGROUND:
  O2:           0.12 %
SET BKG TO:    0.00 % ?

  ↑↓ INC/DEC
  ← SAVE VALUE

RANGE  AVG  DIAGS  ALARM
  
```

O₂ Coefficient

The O₂ Coefficient screen allows the O₂ span coefficients to be changed manually while sampling span gas of known concentration.

The display shows the current O₂ concentration reading. The next line of the display shows the O₂ span coefficient that is stored in memory and is being used to correct the O₂ concentration. Notice that as the span coefficient value is changed, the current O₂ concentration reading on the above line also changes. However, no real changes are made to the value stored in memory until  is pressed. Only proposed changes, as indicated by a question mark prompt, are displayed until  is pressed.

Note The concentration value will show “ERROR” if the measured concentration is not a valid span value (either too high or too low). ▲

- In the Main Menu, choose Calibration Factors > **O₂ Coefficient**.

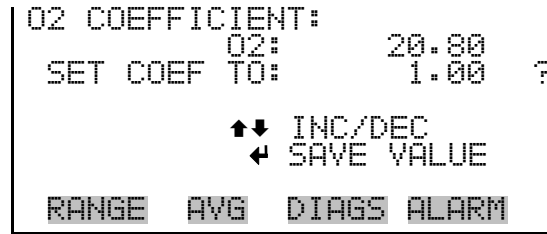

Reset User Calibration Defaults

The Reset User Calibration Defaults screen allows the user to reset the calibration configuration values to factory defaults.

- In the Main Menu, Calibration Factors > **Reset User Cal Defaults**.

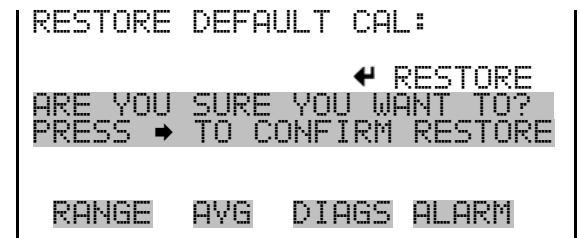
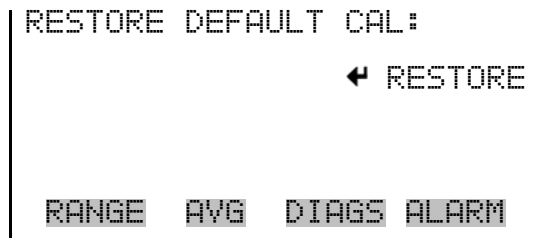

Calibration Menu

The Calibration menu is used to calibrate zero and span. The Calibrate O₂ Background menu item and the Calibrate O₂ Coefficient menu item are displayed only when the internal O₂ sensor option is installed. The calibration menu is similar for the single, dual, and auto range mode as shown below. The only difference between the screens are the words “HI” and “LO” to indicate which range is displayed. The dual and auto range modes have two CO span factors (high and low). This allows each range to be calibrated separately. This is necessary if the two ranges used are not close to one another. For example, a low CO range of 50 ppm and a high CO range of 1,000 ppm. For more information about calibration, see Chapter 4, “[Calibration](#)”.

- In the Main Menu, choose **Calibration**.

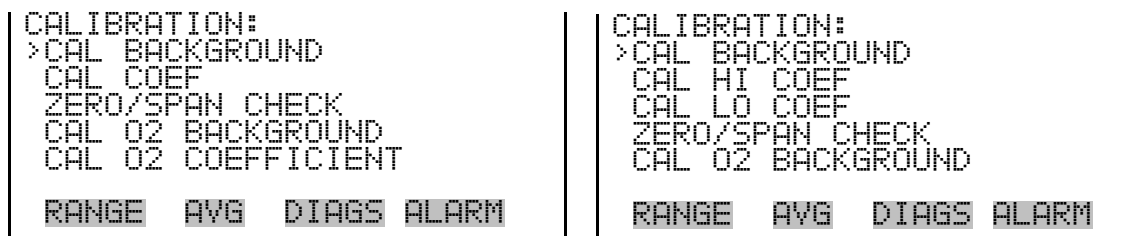

CAL O2 COEFFICIENT

Calibrate CO Background

The Calibrate CO Background screen is used to adjust the instrument zero, or background. Before making an adjustment, be sure the analyzer samples zero air for at least 5 minutes.

It is important to note the averaging time when calibrating. The longer the averaging time, the more accurate the calibration will be. To be most accurate, use the 300-second averaging time. For more information about calibration, see Chapter 4, “[Calibration](#)”.

- In the Main Menu, choose Calibration > **Cal CO Background**.



Calibrate CO Coefficient

The Calibrate CO Coefficient screen is used to adjust the CO coefficient and enter the span concentration. The display shows the current CO concentration reading and the current CO range. The next line of the display is where the CO calibration gas concentration is entered.

The CO span coefficient is calculated, stored, and used to correct the current CO reading. For more information about calibration, see Chapter 4, “[Calibration](#)”. In dual or auto range modes, “HIGH” or “LOW” is displayed to indicate the calibration of the high or low coefficient.

It is important to note the averaging time when calibrating. The longer the averaging time, the more accurate the calibration will be. To be most accurate, use the 300-second averaging time. For more information about calibration, see Chapter 4, “[Calibration](#)”.

- In the Main Menu, choose Calibration > **Cal CO Coefficient**.

```

CALIBRATE CO:
      CO:          15.80
SPAN CONC:      0025.00 ?
      ←→ MOVE CURSOR
      ↑↓ CHANGE VALUE  ← SAVE
RANGE  AVG  DIAGS  ALARM
  
```

Zero/Span Check

The Zero/Span Check menu is available only if the zero/span valve option is installed. It is used to program the instrument to perform fully automated zero and span checks or adjustments.

- In the Main Menu, choose Calibration > **Zero/Span Check**.

```

ZERO/SPAN CHECK:
>NEXT TIME 01Jan09 12:00
PERIOD HR          24
TOTAL DURATION HR 1.5
ZERO DURATION MIN 30
SPAN DURATION MIN 30 ↓
RANGE  AVG  DIAGS  ALARM
  
```

```

PURGE DURATION MIN 30
ZERO/SPAN AVG SEC  60
ZERO CAL RESET     ON
SPAN CAL RESET     OFF
ZERO/SPAN RATIO    1
  
```

Next Time

The Next Time screen is used to view and set the initial date and time (24-hour format) of the zero/span check. Once the initial zero/span check is performed, the date and time of the next zero/span check is calculated and displayed.

- In the Main Menu, choose Calibration > Zero/Span Check > **Next Time**.

```

NEXT DATE AND TIME:
19 MAR 2009 12:34
PRESS ← TO EDIT
RANGE  AVG  DIAGS  ALARM
  
```

```

NEXT DATE AND TIME:
19 MAR 2009 12:34 ?
SETTING:  DAYS
      → SET MONTHS
      ↑↓ CHANGE VALUE
      ← SAVE VALUE
RANGE  AVG  DIAGS  ALARM
  
```

Period Hours The Zero/Span Period Hours screen defines the period or interval between zero/span checks. Periods between 0 and 999 hours are acceptable. To turn the zero/span check off, set the period to 0.

- In the Main Menu, choose Calibration > Zero/Span Check > **Period Hr.**

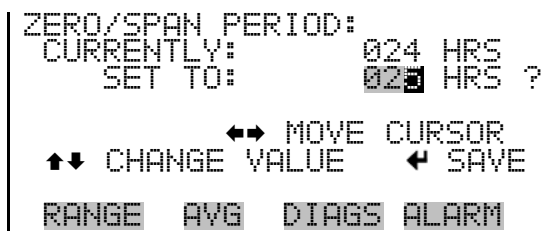

Total Duration Hour The Total Duration Hour line is the sum of the zero, span, and purge duration minutes, and is for viewing only.

Zero/Span/Purge Duration Minutes

The Zero Duration Minutes screen defines how long zero air is sampled by the instrument. The Span and Purge Duration Minutes screens look and function the same way as the zero duration screen. The span duration screen is used to set how long the span gas is sampled by the instrument. The purge duration screen is used to set how long the purge period will be after doing a zero or span check. This gives the instrument time to flush out the zero and span gas before any meaningful data is taken. Logged data is flagged as taken during a purge to show that the data is suspect. Durations between 0 and 99 minutes are acceptable. Each time a zero/span check occurs the zero check is done first, followed by the span check. To perform just a zero check, set the span duration to 0 (off). The same applies to perform just a span check.

- In the Main Menu, choose Calibration > Zero/Span Check > **Zero, Span or Purge Duration Min.**

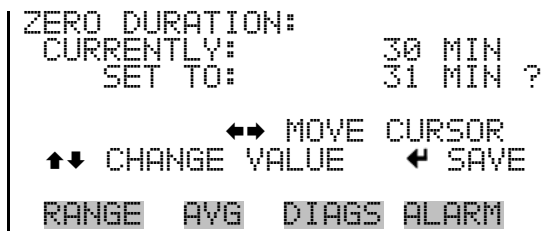

Zero/Span Averaging Time

The Zero/Span Averaging Time screen allows the user to adjust the zero/span averaging time. The zero/span averaging time is used by the analyzer only when performing an automatic zero or span check. The analyzer's averaging time is used for all other functions. The following averaging times are available: 1, 2, 5, 10, 20, 30, 60, 90, 120, 180, 240, and 300 seconds.

- In the Main Menu, choose Calibration > Zero/Span Check > **Zero/Span Avg Sec.**

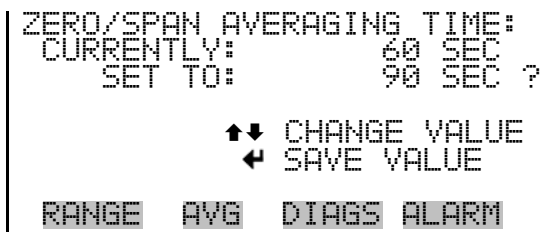

Zero/Span Calibration Reset

Zero and Span Calibration Reset are toggle items that change between yes or no when selected, and are displayed only if Auto Calibration is set to YES in the Instrument Configuration screen in the Diagnostics menu.

If the zero calibration reset line is set to yes, then not only is a zero check done, but a zero adjustment is made. If the span calibration reset line is set to yes, then not only is a span check done, but a span adjustment is made. (This is how to set up a scheduled, recurring auto calibration.)

Zero/Span Ratio

The Zero/Span Ratio screen is used to set the ratio of zero checks to span checks. For example, if this value is set to 1, a span check will follow every zero check. If this value is set to 3, there will be three zero checks between each span check. This value may be set from 1 to 10, with 1 as default.

- In the Main Menu, choose Calibration > Zero/Span Check > **Zero/Span Ratio.**

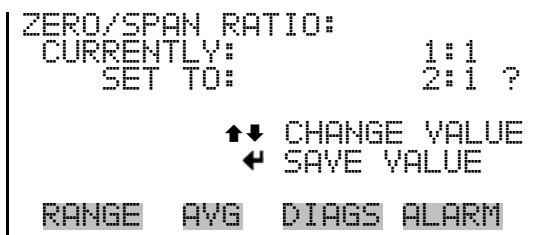

Calibrate O₂ Background

The Calibrate O₂ Background screen is used to adjust the background, or perform a “zero calibration.” Be sure the analyzer samples nitrogen until the readings stabilize. The display shows the current O₂ reading.

- In the Main Menu, choose Calibration > **Calibrate O₂ Background**.

```

O2 BACKGROUND:
  O2:          0.12 %
CURRENTLY:     0.00 % ?
      ← SET O2 TO ZERO

RANGE  AVG  DIAGS  ALARM
  
```

Calibrate O₂ Coefficient

The Calibrate O₂ Coefficient screen is used to adjust the O₂ span concentration while sampling span gas of known concentration.

The display shows the current O₂ concentration reading. The next line of the display is where the O₂ calibration gas concentration is entered.

- In the Main Menu, choose Calibration > **Calibrate O₂ Coefficient**.

```

CALIBRATE O2:
  O2:          20.80 %
SPAN CONC:    20.80
      ↔ MOVE CURSOR
      ↑↓ CHANGE VALUE  ← SAVE

RANGE  AVG  DIAGS  ALARM
  
```

Instrument Controls Menu

The Instrument Controls menu contains a number of items that may be selected to control various instrument operational parameters. The firmware controls listed in this menu enable control of the listed instrument functions. The O₂ Compensation menu item is only displayed if the internal O₂ sensor option is installed.

- In the Main Menu, choose **Instrument Controls**.

```
INSTRUMENT CONTROLS:
>DATALOGGING SETTINGS
  COMMUNICATION SETTINGS
  I/O CONFIGURATION
  TEMPERATURE COMPENSATION
  PRESSURE COMPENSATION  ↓
  RANGE  AVG  DIAGS  ALARM

O2 COMPENSATION
SCREEN CONTRAST
SERVICE MODE
DATE/TIME
TIMEZONE
```

Datalogging Settings

The *i*Series instruments include a built-in datalogging capability as a standard feature. The operator is allowed to create two different types of records, which for historical reasons, are named lrecs and srecs. Each record can contain up to 32 different fields, or data items, and records can be created at user-defined intervals ranging from 1 to 60 minutes.

Record generation is tied to the instrument's real-time clock. For example, if the logging period for srecs is set to 30 minutes, a new srec will be generated on every hour and every half hour (10:00, 10:30, 11:00 ...). Lrecs and srecs function independent of each other. For example, an srec containing just the current concentration level could be generated every five minutes while an lrec containing a full set of diagnostic data could be generated once every hour.

The analyzer's computer system includes three megabytes of flash memory which is enough to store a full lrec containing 32 data items and a full srec containing 32 items once each minute for a week (>20,000 total records). If logging is limited to the minimum content of date, time, concentration and error flags, the analyzer can store data once each minute for 4 months (>190,000 total records).

The Datalogging Settings menu allows the user flexibility in how data is stored and recorded.

- In the Main Menu, choose Instrument Controls > **Datalogging Settings**.

```

DATALOGGING SETTINGS:
>SELECT SREC/LREC      SREC
VIEW LOGGED DATA
ERASE LOG
SELECT CONTENT
COMMIT CONTENT
                                ↓
RANGE  AVG  DIAGS  ALARM

RESET TO DEFAULT CONTENT
CONFIGURE DATALOGGING
  
```

Select Srec/Lrec

The Select Srec/Lrec screen is used to select the log record type for other operations in this menu.

- In the Main Menu, choose Instrument Controls > Datalogging Settings > Select Srec/Lrec.

```

SELECT LOG TYPE:
CURRENTLY:      SREC
SET TO:         LREC ?
                ← TOGGLE VALUE
RANGE  AVG  DIAGS  ALARM
  
```

View Logged Data

The View Logged Data screen is used to select the starting point to view the logged data by the number of records or by date and time. Note that both types of records cannot be viewed at the same time, only the selected record type.

- In the Main Menu, choose Instrument Controls > Datalogging Settings > View Logged Data.

```

SELECT START POINT BY:
SET TO: # OF RECS
        ↑↓ CHANGE    ← ACCEPT
RANGE  AVG  DIAGS  ALARM
  
```

Number of Records

The Number of Records screen is used to select the number of records to view, ending with the most recent. It also shows the total number of records that have been logged for the selected record type.

Operation

Instrument Controls Menu

```
SET # BACK FROM CURRENT:
TOTAL LRECS: 00000000
                20
      ↔ MOVE CURSOR
  ↑↓ CHANGE VALUE  ← SAVE
RANGE  AVG  DIAGS  ALARM
```

The Record Display screen (read only) displays the selected records.

```
time    date    flags
10:01  01/20/09  FC0088900
10:02  01/20/09  FC0088900
10:03  01/20/09  FC0088900
10:04  01/20/09  FC0088900
  ↑↓ PGUP/DN  ↔ PAN L/R
RANGE  AVG  DIAGS  ALARM
```

Date and Time

The Date and Time screen is used to set a start date and time for which to view logged data. For example, if “20 Jan 2009 10:00” is entered, then the first logged data record that is displayed is the first record after this time. If set to one minute logging, this would be at “20 Jan 2009 10:01”.

```
DATE AND TIME:
20 JAN 2009  10:00
  ↑↓ CHG  DAYS
  → SET CURSOR TO MONTHS
  ← ACCEPT AS SHOWN
RANGE  AVG  DIAGS  ALARM
```

The Record Display screen (read only) displays the selected records.

```
time    date    flags
10:01  01/20/09  FC0088900
10:02  01/20/09  FC0088900
10:03  01/20/09  FC0088900
10:04  01/20/09  FC0088900
  ↑↓ PGUP/DN  ↔ PAN L/R
RANGE  AVG  DIAGS  ALARM
```

Erase Log The Erase Log screen is used to erase all saved data for the selected record type only (not both srecs and lrecs).

- In the Main Menu, choose Instrument Controls > Datalogging Settings > **Erase Log**.

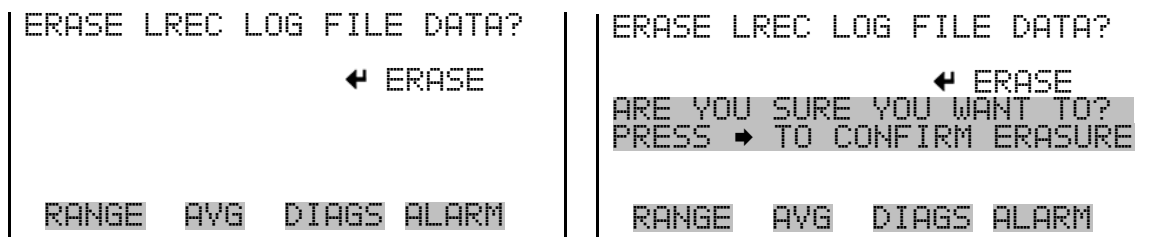

Select Content The Select Content submenu displays a list of 32 record fields to use to configure the data to be logged. When a field is selected, a submenu list appears of the items to choose from to assign to those fields. Item types are Concentrations, Corrected Concentrations (if the O₂ compensation option is enabled), Other Measurements, and Analog Inputs (if the I/O expansion board is installed). These record fields comprise a temporary list of items for the selected record type that must be committed via the datalogging menu before the changes will apply. Note that committing any changes to this list will erase all currently logged data for the selected record type only, as the format of the stored data is changed.

- In the Main Menu, choose Instrument Controls > Datalogging Settings > **Select Content**.

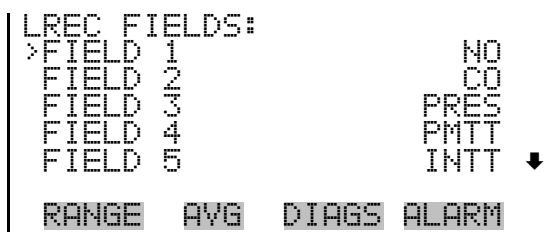

Choose Field Data The Choose Field Data submenu displays a list of the types of data that can be logged for the current field. Choices are Concentrations, Corrected Concentrations (if the O₂ compensation option is enabled), Other Measurements, and Analog Inputs (if the I/O expansion board is installed).

- In the Main Menu, choose Instrument Controls > Datalogging Settings > Select Content > **Field 1–32**.

```
DATA IN SREC FIELD 1:  
>CONCENTRATIONS  
CORRECTED CONCENTRATIONS  
OTHER MEASUREMENTS  
ANALOG INPUTS  
  
RANGE  AVG  DIAGS  ALARM
```

Concentrations

The Concentrations screen allows the user to assign one of the concentrations to the selected record field. The selected item is shown by “<--” after it. Note that at this point, pressing  indicates that these are proposed changes as opposed to implemented changes. To change the selected record format and erase record log file data, see “Commit Content” below. Range status is visible only in auto range mode. O₂ % is visible only if the O₂ compensation option is enable.

- In the Main Menu, choose Instrument Controls > Datalogging Settings > Select Content > select Field > **Concentrations**.

```
CONCENTRATIONS:  
>NONE  
RANGE STATUS  
CO <--  
LO CO  
HI CO  
  
RANGE  AVG  DIAGS  ALARM  
  
O2 %
```

Corrected Concentrations

The Corrected Concentrations screen allows the user to select the output signal that is tied to the selected field item. The selected item is shown by “<--” after it. Note that at this point, pressing  indicates that these are proposed changes as opposed to implemented changes. To change the selected record format and erase record log file data, see “Commit Content” below. This screen is only displayed if the O₂ compensation option is enabled.

- In the Main Menu, choose Instrument Controls > Datalogging Settings > Select Content > select Field > **Corrected Concentrations**.

```

CORRECTED CONCENTRATIONS:
>NONE
CO COR          <--
LO CO COR
HI CO COR

RANGE  AVG  DIAGS  ALARM
  
```

Other Measurements

The Other Measurements screen allows the user to assign one of the other available measurement types to the selected record field. The selected item is shown by “<--” after it. Items displayed are determined by the options installed. Note that at this point, pressing  indicates that these are proposed changes as opposed to implemented changes. To change the selected record format and erase record log file data, see “Commit Content” below.

- In the Main Menu, choose Instrument Controls > Datalogging Settings > Select Content > select Field > **Other Measurements**.

```

OTHER MEASUREMENTS:
>NONE
S/R
LO S/R
HI S/R
INT TEMP          ↓

RANGE  AVG  DIAGS  ALARM
  
```

```

BENCH TEMP
BENCH PRES
SAMPLE FLOW
INTENSITY
MOTOR SPEED
BIAS SUPPLY
EXT ALARMS
O2 SENSOR TEMP
  
```

Analog Inputs

The Analog Inputs screen allows the user to select the parameter (none or analog inputs 1–8) to the selected record field. The selected item is shown by “<--” after it. Note that at this point, pressing  indicates that these are proposed changes as opposed to implemented changes. To change the selected record format and erase record log file data, see “Commit Content” below.

- In the Main Menu, choose Instrument Controls > Datalogging Settings > Select Content > select Field > **Analog Inputs**.

Operation

Instrument Controls Menu

```
ANALOG INPUTS:
>NONE
ANALOG IN 1
ANALOG IN 2
ANALOG IN 3
ANALOG IN 4
↓
RANGE  AVG  DIAGS  ALARM
```

Commit Content

The Commit Content screen is used to save any changes that have been made to any of the record fields for the selected record type. Saving changes will erase record log file data for that record type. If no changes have been made “NO CHANGES TO RECORD LIST!” will appear. For more information about selecting the analog output signal group choices, see “[Select Content](#)” above.

- In the Main Menu, choose Instrument Controls > Datalogging Settings > **Commit Content**.

```
CHANGE LREC DATA AND
ERASE LREC LOG FILE DATA?
      ← COMMIT
RANGE  AVG  DIAGS  ALARM
```

```
CHANGE LREC DATA AND
ERASE LREC LOG FILE DATA?
      ← COMMIT
ARE YOU SURE YOU WANT TO?
PRESS → TO CONFIRM ERASURE
RANGE  AVG  DIAGS  ALARM
```

Reset to Default Content

The Reset to Default Content screen is used to reset all of the datalogging field items to default values for the selected record type. For more information about selecting the analog output signal group choices, see “[Select Content](#)” above.

- In the Main Menu, choose Instrument Controls > Datalogging Settings > **Reset to Default Content**.

```
RESET LREC DATA AND
ERASE LREC LOG FILE DATA?
      ← RESET
RANGE  AVG  DIAGS  ALARM
```

```
RESET LREC DATA AND
ERASE LREC LOG FILE DATA?
      ← RESET
ARE YOU SURE YOU WANT TO?
PRESS → TO CONFIRM RESET
RANGE  AVG  DIAGS  ALARM
```

Configure Datalogging

The Configure Datalogging menu deals with datalogging configuration for the currently selected record type.

- In the Main Menu, choose Instrument Controls > Datalogging Settings > **Configure Datalogging**.

```

DATALOGGING SETTINGS:
>LOGGING PERIOD MIN    60
MEMORY ALLOCATION %     50
DATA TREATMENT         AVG
FLAG STATUS DATA     OFF

RANGE  AVG  DIAGS  ALARM
  
```

Logging Period Min

The Logging Period Min screen is used to select the logging period in minutes for the selected record format (srec or lrec). List of choices include: off, 1, 5, 15, 30, and 60 minutes (default).

- In the Main Menu, choose Instrument Controls > Datalogging Settings > Configure Datalogging > **Logging Period Min**.

```

SET PERIOD FOR SREC:
CURRENTLY:         60 MIN
SET TO:           OFF MIN ?

↑↓ CHANGE VALUE   ← SAVE

RANGE  AVG  DIAGS  ALARM
  
```

Memory Allocation Percent

The Memory Allocation Percent screen is used to select the percentage of total memory that may be used by the selected record type (lrecs or srecs). Percentages between 0 and 100% are available in increments of 10. Changing this value results in log erasure for both types of records, and changing the percent allocated to one record type will automatically change the other.

- In the Main Menu, choose Instrument Controls > Datalogging Settings > Configure Datalogging > **Memory Allocation %**.

Operation

Instrument Controls Menu

```
SET PERCENT LRECS:
CURRENTLY:      50%
SET TO:        60% ?

↑↓ CHANGE VALUE  ← SAVE

RANGE  AVG  DIAGS  ALARM
```

```
SET PERCENT LRECS:
CURRENTLY:      50%
SET TO:        60% ?
THIS WILL ERASE ALL LOGS!
PRESS → TO CONFIRM CHANGE

RANGE  AVG  DIAGS  ALARM
```

Data Treatment

The Data Treatment screen is used to select the data type for the selected record type: whether the data should be averaged over the interval, the minimum or maximum measured during the interval, or the current value (last value measured). Data treatment doesn't apply to all data, just to the concentration measurement. All other data points log the current value at the end of the interval.

Note If Data Treatment is set to AVG, Datalogging averaging is done in addition to the normal concentration averaging. ▲

- In the Main Menu, choose Instrument Controls > Datalogging Settings > Configure Datalogging > **Data Treatment**.

```
SET LREC DATA TYPE:
CURRENTLY:  AVG
SET TO:    CUR

↑↓ CHANGE VALUE  ← SAVE

RANGE  AVG  DIAGS  ALARM
```

Flag Status Data

The Flag Status Data is used to set flag status data On/Off. Refer to “Flags Status” in Appendix B.

- In the Main Menu, choose Instrument Controls > Datalogging Settings > Configure Datalogging > **Flag Status Data**.

```
SET LREC FLAG STATUS DATA:
CURRENTLY:  OFF
SET TO:    ON ?

↑↓ CHANGE VALUE  ← SAVE

RANGE  AVG  DIAGS  ALARM
```

Communication Settings

The Communication Settings menu is used for communications control and configuration.

- In the Main Menu, choose Instrument Controls > **Communication Settings**.

```

COMMUNICATION SETTINGS:
>SERIAL SETTINGS
  INSTRUMENT ID
  GESYTEC SERIAL NO
  COMMUNICATION PROTOCOL
  STREAMING DATA CONFIG

RANGE  AVG  DIAGS  ALARM

TCP/IP SETTINGS
  
```

Serial Settings

The Serial Setting submenu is used for serial communications control and configuration.

- In the Main Menu, choose Instrument Controls > Communication Settings > **Serial Settings**.

```

SERIAL SETTINGS:
>BAUD RATE           9600
  DATA BITS         8
  PARITY              NONE
  STOP BITS          1
  RS-232/485 SEL     RS-232

RANGE  AVG  DIAGS  ALARM
  
```

Baud Rate

The Baud Rate screen is used to set the RS-232/RS-485 interface baud rate. Baud rates of 1200, 2400, 4800, 9600, 19200, 38400, 57600, and 115200 are available. The analyzer's default baud rate is set to 9600 to provide backwards compatibility with the older C-series analyzers.

- In the Main Menu, choose Instrument Controls > Communication Settings > Serial Settings > **Baud Rate**.

Operation

Instrument Controls Menu

```
BAUD RATE:
CURRENTLY:          9600
SET TO:            19200 ?

      ↑↓ CHANGE VALUE
      ← SAVE VALUE

RANGE  AVG  DIAGS  ALARM
```

Data Bits The Data Bits screen is used to set the number of serial data bits to either 7 or 8 (default).

- In the Main Menu, choose Instrument Controls > Communication Settings > Serial Settings > **Data Bits**.

```
DATA BITS:
CURRENTLY:          8
SET TO:            7 ?

      ↑↓ CHANGE VALUE
      ← SAVE VALUE

RANGE  AVG  DIAGS  ALARM
```

Parity The Parity screen is used to select the parity bit for the serial port to None (default), Even, or Odd.

- In the Main Menu, choose Instrument Controls > Communication Settings > Serial Settings > **Parity**.

```
PARITY:
CURRENTLY:          NONE
SET TO:            ODD ?

      ↑↓ CHANGE VALUE
      ← SAVE VALUE

RANGE  AVG  DIAGS  ALARM
```

Stop Bits The Stop Bits screen is used to set the number of stop bits for the serial port to 1 (default) or 2.

- In the Main Menu, choose Instrument Controls > Communication Settings > Serial Settings > **Stop Bits**.

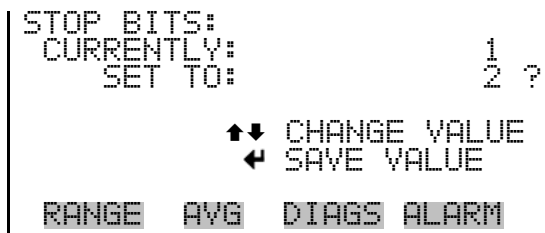

RS-232/RS-485 Selection

The RS-232/RS-485 Selection screen allows the user to choose between the RS-232 or RS-485 specification for serial communication.



Equipment Damage Disconnect the serial cable before changing RS-232 and RS-485 selection to prevent damage to any equipment currently connected to the analyzer. ▲

- In the Main Menu, choose Instrument Controls > Communication Settings > Serial Settings > **RS-232/485 Sel.**

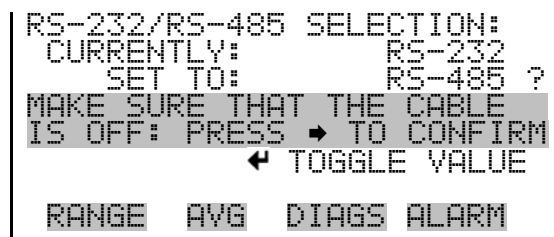

Instrument ID

The Instrument ID screen allows the operator to edit the instrument identification number (ID). The ID is used to identify the instrument when using the C-Link or MODBUS protocols to control the instrument or collect data. It may be necessary to edit the ID number if two or more of instruments of the same model are connected to one computer. Valid instrument ID numbers are from 0 to 127. The Model 48i has a default instrument ID of 48. For more information about the Instrument ID, see Appendix B “C-Link Protocol Commands” or Appendix C “MODBUS Protocol”.

- In the Main Menu, choose Instrument Controls > Communication Settings > **Instrument ID.**

Operation

Instrument Controls Menu

```
INSTRUMENT ID:
CURRENTLY:      48
SET TO:         50 ?

  ↑↓ CHANGE VALUE
  ← SAVE VALUE

RANGE  AVG  DIAGS  ALARM
```

Gesytec Serial No

A Gesytec serial number is included in the response to a Gesytec protocol DA command. Refer to “[Data Sampling/Data Query Command \(DA\)](#)” on page [D-4](#) for detailed information and examples.

A Gesytec serial number defaults to zero.

- In the Main Menu, choose Instrument Controls > Communication Settings > **Gesytec Serial No.**

```
GESYTEC SERIAL NO:
CURRENTLY:         0
SET TO:           0 ?

  ↑↓ CHANGE VALUE
  ← SAVE VALUE

RANGE  AVG  DIAGS  ALARM
```

Communication Protocol

The Communication Protocol screen is used to change the protocol for serial communications. Possible settings are C-Link, MODBUS, Gesytec, and Streaming.

C-link Protocol - C-link is a bi-directional protocol that provides access to all instrument functions including reading the various concentrations and other analog values or variables, reading the status of the digital outputs of the instrument, and triggering or simulating the activation of a digital input to the instrument. Refer to Appendix B for detailed C-link information.

Streaming Protocol - The streaming protocol provides a one-way reporting capability in which data records are exported to a serial device on a regular basis without prompting.

Gesytec (Bayern-Hessen) protocol - The Gesytec (Bayern-Hessen) protocol support for the Model 48*i* enables the user to read the various concentrations. Refer to Appendix D for detailed Gesytec (Bayern-Hessen) information.

MODBUS protocol – The MODBUS protocol is a serial communications protocol that allows for communication between devices connected to the same network.

The MODBUS protocol support for the Model 48*i* enables the user to read the various concentrations and other analog values or variables, read the status of the digital outputs of the instrument, and to trigger or simulate the activation of a digital input to the instrument. Refer to Appendix C for detailed MODBUS protocol information.

- In the Main Menu, choose Instrument Controls > Communication Settings > **Communication Protocol**.

```

COMMUNICATION PROTOCOL:
CURRENTLY:             CLINK
SET TO:                STREAMING ?

      ↑↓ CHANGE VALUE
      ← SAVE VALUE

RANGE  AVG  DIAGS  ALARM
  
```

Streaming Data Configuration

The Streaming Data Configuration menu is used to allow for configuration of the 8 streaming data output items, streaming interval, current data format, and current timestamp setting. The Choose Item Signal submenu displays a list of the analog output signal group choices to choose from. Choices are Concentrations, Corrected Concentrations (if the O₂ compensation option is enabled), Other Measurements, and Analog Inputs (if the I/O expansion board option is installed).

Note The selected item list is different depending on the AUTO/MANUAL MODE and RANGE MODE settings. Changing either of these settings will produce a different set of streaming data items. If either of these modes is going to be changed on a regular basis, then the user must configure each set of data separately after changing the modes to each setting. ▲

- In the Main Menu, choose Instrument Controls > Communication Settings > **Streaming Data Config**.

Operation

Instrument Controls Menu

```
STREAMING DATA CONFIG
>INTERVAL          10 SEC
ADD LABELS        NO
PREPEND TIMESTAMP YES
ADD FLAGS         YES
ITEM 1            CO ↓
RANGE  AVG  DIAGS  ALARM
```

Streaming Data Interval

The Streaming Data Interval screen is used to adjust how frequently a new record will be generated. The following interval times are available: 1, 2, 5, 10, 20, 30, 60, 90, 120, 180, 240, and 300 seconds.

- In the Main Menu, choose Instrument Controls > Communication Settings > Streaming Data Config > **Interval**.

```
STREAMING DATA INTERVAL:
CURRENTLY:          10 SEC
SET TO:            20 SEC ?
      ↑↓ CHANGE VALUE
      ← SAVE VALUE
RANGE  AVG  DIAGS  ALARM
```

Add Labels

The Add Labels screen allows the operator to toggle between YES and NO. If set to YES, then each data point in the streaming record will have a label attached.

- In the Main Menu, choose Instrument Controls > Communication Settings > Streaming Data Config > **Add Labels**.

Prepend Timestamp

The Prepend Time Stamp screen allows the operator to toggle between YES and NO. If set to YES, then each streaming data record will start with a time and date stamp indicating when that record was generated.

- In the Main Menu, choose Instrument Controls > Communication Settings > Streaming Data Config > **Prepend Timestamp**.

Add Flags

The Add Flags screen allows the operator to toggle between YES and NO. If set to YES, then each streaming data record will include a set of flags that indicate various diagnostic or alarm conditions.

- In the Main Menu, choose Instrument Controls > Communication Settings > Streaming Data Config > **Add Flags**.

Choose Stream Data Item

The Choose Stream Data screen displays a list of the types of data that can be sent via streaming data. Choices are Concentrations, Corrected Concentrations (if the O₂ compensation option is enabled), Other Measurements, and Analog Inputs, (if the I/O board is installed).

- In the Main Menu, choose Instrument Controls > Communication Settings > Streaming Data Config > **Item 1-8**.

```

CHOOSE STREAM DATA:
>CONCENTRATIONS
CORRECTED CONCENTRATIONS
OTHER MEASUREMENTS
ANALOG INPUTS

RANGE  AVG  DIAGS  ALARM
  
```

Concentrations

The Concentrations screen allows the user to assign one of the concentrations to the selected streaming data item. The currently selected item is shown by “<--” after it. Once an item is selected, pressing  will save the selected streaming data item. In dual or auto range mode, “HI” or “LO” is displayed to indicate high or low range concentrations. Rang Status is visible only in auto range mode. O₂ % is visible only if the O₂ compensation option is enable.

- In the Main Menu, choose Instrument Controls > Communication Settings > Streaming Data Config > select Item > **Concentrations**.

```

CONCENTRATIONS:
>NONE
CO                               <--
LO CO
HI CO
RANGE STATUS

RANGE  AVG  DIAGS  ALARM

O2 %
  
```

Corrected Concentrations

The Corrected Concentrations screen allows the user to select the output signal that is tied to the selected streaming data item. The currently selected item is shown by “<--” after it. Once an item is selected, pressing  will save the selected streaming data item. In dual or auto range mode, “HI” or “LO” is displayed to indicate high or low range concentrations. This screen is only displayed if the O₂ compensation option is enabled.

Operation

Instrument Controls Menu

- In the Main Menu, choose Instrument Controls > Communication Settings > Streaming Data Config > select Item > **Corrected Concentrations**.

```
CORRECTED CONCENTRATIONS:
>NONE
CO COR          <--
LO CO COR
HI CO COR

RANGE  AVG  DIAGS  ALARM
```

Other Measurements

The Other Measurements screen allows the user to assign one of the other available measurement types to the selected streaming data item. The currently selected item is shown by “<--” after it. In dual or auto range mode, “HI” or “LO” is displayed to indicate high or low concentrations. Once an item is selected, pressing  will save the selected streaming data item.

- In the Main Menu, choose Instrument Controls > Communication Settings > Streaming Data Config > select Item > **Other Measurements**.

```
OTHER MEASUREMENTS:
>NONE
S/R
LO S/R
HI S/R
INT TEMP          ↓

RANGE  AVG  DIAGS  ALARM
```

```
BENCH TEMP
BENCH PRES
SAMPLE FLOW
INTENSITY
MOTOR SPEED
BIAS SUPPLY
EXT ALARMS
O2 SENS TEMP
```

Analog Inputs

The Analog Inputs screen allows the user to assign an analog input signal (none or analog inputs 1–8) to the selected streaming data item. The currently selected item is shown by “<--” after it. Once an item is selected, pressing  will save the selected streaming data item.

- In the Main Menu, choose Instrument Controls > Communication Settings > Streaming Data Config > select Item > **Analog Inputs**.

```

ANALOG INPUTS:
>NONE
ANALOG IN 1
ANALOG IN 2
ANALOG IN 3
ANALOG IN 4
                                     ↓
RANGE  AVG  DIAGS  ALARM
  
```

TCP/IP Settings The TCP/IP Settings menu is used for defining parameters that are required for Ethernet communications.

Note The instrument power must be cycled after any of these parameters have been changed for the change to take effect. ▲

- In the Main Menu, choose Instrument Controls > Communication Settings > **TCP/IP Settings**.

```

TCP/IP SETTINGS:
>USE DHCP                OFF
IP ADDR                 192.168.1.200
NETMASK                 255.255.255.0
GATEWAY                 192.168.1.15
HOST NAME                iSeries ↓
RANGE  AVG  DIAGS  ALARM
NTP SVR                192.168.1.15
  
```

Use DHCP The Use DHCP screen is used to specify whether to use Dynamic Host Configuration Protocol (DHCP) or not. When DHCP is enabled, the network dynamically provides an IP address for the instrument.

- In the Main Menu, choose Instrument Controls > Communication Settings > TCP/IP Settings > **Use DCHP**.

```

DHCP:
CURRENTLY:                OFF
SET TO:                   ON ?
                                ← TOGGLE VALUE
CYCLE POWER TO CHANGE DHCP
RANGE  AVG  DIAGS  ALARM
  
```

IP Address The IP Address screen is used to edit the IP address. The IP address can only be changed when DHCP is off. If DHCP is on, the instrument will respond with “NOT SETTABLE IF DHCP IS ON”. For more information on DHCP, see “[Use DHCP](#)” above.

- In the Main Menu, choose Instrument Controls > Communication Settings > TCP/IP Settings > **IP Address**.

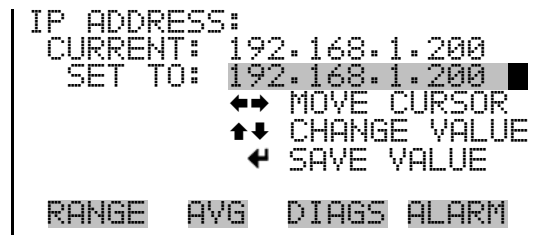

Netmask The Netmask screen is used to edit the netmask. The netmask is used to determine the subnet on which the instrument can directly communicate to other devices. The netmask can only be changed when DHCP is off. If DHCP is on, the instrument will respond with “NOT SETTABLE IF DHCP IS ON”. For more information on DHCP, see “[Use DHCP](#)” above.

- In the Main Menu, choose Instrument Controls > Communication Settings > TCP/IP Settings > **Netmask**.

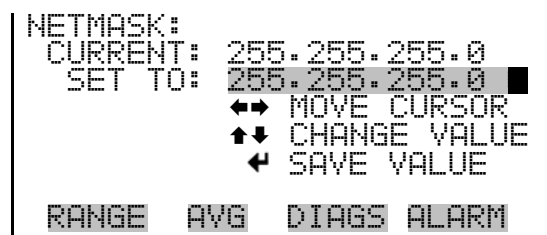

Default Gateway The Default Gateway screen is used to edit the gateway address. The default gateway can only be changed when DHCP is off. If DHCP is on, the instrument will respond with “NOT SETTABLE IF DHCP IS ON”. For more information on DHCP, see “[Use DHCP](#)” above. Any traffic to addresses that are not on the local subnet will be routed through this address.

- In the Main Menu, choose Instrument Controls > Communication Settings > TCP/IP Settings > **Gateway**.

```

DEFAULT GATEWAY:
CURRENT: 192.168.1.15
SET TO: 192.168.1.15
      ← MOVE CURSOR
      ↑↓ CHANGE VALUE
      ← SAVE VALUE

RANGE  AVG  DIAGS  ALARM
  
```

Host Name

The Host Name screen is used to edit the host name. When DHCP is enabled, this name is reported to the DHCP server.

- In the Main Menu, choose Instrument Controls > Communication Settings > TCP/IP Settings > **Host Name**.

```

HOST NAME:
CURRENT:  I SERIES
      I SERIES ?
      ABCDEFGHIJKLMNOP BKSP
      OPQRSTUVWXYZ PAGE
      0123456789 ./- SAVE

RANGE  AVG  DIAGS  ALARM
  
```

Network Time Protocol Server

The Network Time Protocol (NTP) Server screen is used to edit the IP address of the NTP server. An NTP server may be used to periodically synchronize the instrument's real-time clock with a standard. More information about the NTP servers and a list of public servers may be found at <http://www.ntp.org>.

- In the Main Menu, choose Instrument Controls > Communication Settings > TCP/IP Settings > **NTP Svr.**

```

NTP SERVER IP ADDRESS:
CURRENT: 192.168.1.20
SET TO: 192.168.001.01
      ← MOVE CURSOR
      ↑↓ CHANGE VALUE
      ← SAVE VALUE

RANGE  AVG  DIAGS  ALARM
  
```

I/O Configuration

The I/O Configuration menu deals with configuration of the analyzer's I/O system. The analog input configuration is displayed only if the I/O expansion board option is installed.

- In the Main Menu, choose Instrument Controls > **I/O Configuration**.

```
I/O CONFIGURATION:
>OUTPUT RELAY SETTINGS
DIGITAL INPUT SETTINGS
ANALOG OUTPUT CONFIG
ANALOG INPUT CONFIG

RANGE  AVG  DIAGS  ALARM
```

Output Relay Settings

The Output Relay Settings menu displays a list of the 10 digital output relays available, and allows the user to select the logic state or instrument parameter for the relay selected.

Note The digital outputs may take up to one second after the assigned state occurs to show up on the outputs. ▲

- In the Main Menu, choose Instrument Controls > I/O Configuration > **Output Relay Settings**.

```
OUTPUT RELAY SETTINGS:
>1  NOP          GEN  ALARM
2  NOP          NONE
3  NOP          UNITS
4  NOP          CONC  ALARM
5  NOP          NONE  ↓

RANGE  AVG  DIAGS  ALARM
```

Logic State

The Logic State menu item is used to change the selected I/O relay to either normally open or normally closed. The default state is open, which indicates that a relay connected between the digital output pin and ground is normally open and closes to trigger the digital output action.

- Press  to toggle and set the logic state open or closed.

```
OUTPUT RELAY SETUP:
>LOGIC STATE          OPEN
INSTRUMENT STATE

RANGE  AVG  DIAGS  ALARM
```

Instrument State

The Instrument State submenu allows the user to select the instrument state that is assigned to the selected relay output. A submenu lists signal types of either alarm or non-alarm to choose from.

- In the Main Menu, choose Instrument Controls > I/O Configuration > Output Relay Settings > select Relay > **Instrument State**.

```

CHOOSE SIGNAL TYPE:
>ALARMS
NON-ALARM

RANGE  AVG  DIAGS  ALARM
  
```

Alarms

The Alarms screen allows the user to select the alarm status for the selected relay output. The selected item is shown by “<--” after it. The I/O board status alarm is only present if the I/O expansion board is installed. Zero and Span Check Cal are only present if the automated zero/span check is enabled. The O₂ conc items are only displayed if the internal O₂ sensor option is installed. See the Alarms Menu section later in this chapter for more information on alarm items.

- In the Main Menu, choose Instrument Controls > I/O Configuration > Output Relay Settings > select Relay > Instrument State > **Alarms**.

```

ALARM STATUS ITEMS:
>NONE
GEN ALARM
CONC MAX
CONC MIN
INT TEMP
↓

RANGE  AVG  DIAGS  ALARM
  
```

```

BENCH TEMP
PRESSURE
SAMPLE FLOW
INTENSITY
MOTOR SPEED
BIAS VOLTAGE
ME STATUS
MIB STATUS
I/O BD STATUS
CONC ALARM
ZERO CHK/CAL
SPAN CHK/CAL
EXT ALARM 1
EXT ALARM 2
<--
  
```

Operation

Instrument Controls Menu

```
EXT ALARM 3
O2 CONC MAX
O2 CONC MIN
```

Non-Alarm

The Non-Alarm status screen allows the user to select the non-alarm status for the selected relay output. The selected item is shown by “<--” after it.

- In the Main Menu, choose Instrument Controls > I/O Configuration > Output Relay Settings > select Relay > Instrument State > **Non-Alarm**.

```
NON ALARM STATUS ITEMS:
>NONE
AUTORANGE
LOCAL/REMOTE
SERVICE
UNITS
                                ↓
RANGE  AVG  DIAGS  ALARM

ZERO MODE
SPAN MODE
SAMPLE MODE
PURGE MODE
```

Digital Input Settings

The Digital Input Settings menu displays a list of the 16 digital inputs available, and allows the user to select the logic state and instrument parameter for the relay selected.

Note The digital inputs must be asserted for at least one second for the action to be activated. ▲

Note Not all of the I/O available in the instrument is brought out on the supplied terminal board. If more I/O is desired, an alternative means of connection is required. (See optional [Terminal Block and Cable Kits](#).) ▲

- In the Main Menu, choose Instrument Controls > I/O Configuration > **Digital Input Settings**.

```
DIGITAL INPUT SETTINGS:
>1  NOP  SET BACKGROUND
 2  NOP  CAL TO LO SPAN
 3  NOP  AOUTS TO ZERO
 4  NOP  AOUTS TO FS
 5  NOP  NONE
                                ↓
RANGE  AVG  DIAGS  ALARM
```

Logic State The Logic State menu item is used to change the selected I/O relay to either normally open or normally closed. The default state is open, which indicates that a relay connected between the digital input pin and ground is normally open and closes to trigger the digital input action.

- Press  to toggle and set the logic state to normally open or normally closed.

```
DIGITAL INPUT SETUP:
>LOGIC STATE      OPEN
INSTRUMENT STATE

RANGE  AVG  DIAGS  ALARM
```

Instrument Action The Instrument Action submenu allows the user to choose the instrument action that is assigned to the selected digital input. The zero, span and purge modes are only present if the zero/span valve option is installed.

- In the Main Menu, choose Instrument Controls > I/O Configuration > Digital Input Settings > select Relay > **Instrument Action**.

```
CHOOSE ACTION:
>NONE
ZERO MODE
SPAN MODE
SET BACKGROUND
CAL TO LO SPAN

RANGE  AVG  DIAGS  ALARM
```

```
ROUTS TO ZERO
ROUTS TO FS
CAL TO HI SPAN
EXT ALARM 1
EXT ALARM 2
EXT ALARM 3
PURGE MODE
```

**Analog Output Configuration
(Select Channel)**

The Analog Output Configuration menu displays a list of the analog output channels available for configuration. Channel choices include all voltage channels, all current channels, individual voltage channels 1–6, and individual current channels 1–6 (if the I/O expansion board option is installed).

- In the Main Menu, choose Instrument Controls > I/O Configuration > **Analog Output Config.**

```
OUTPUT CHANNELS:  
>ALLOW OVER/UNDER RANGE  
ALL VOLTAGE CHANNELS  
ALL CURRENT CHANNELS  
VOLTAGE CHANNEL 1  
VOLTAGE CHANNEL 2  
RANGE  AVG  DIAGS  ALARM
```

Allow Over/Under Range

The Allow Over/Under Range screen is used to select whether or not the analog outputs are allowed to exceed the maximum selected value of 100 mV, 1 V, 5 V, 10 V, or 20 mA or the minimum selected value of 0 V, 0 mA, or 4 mA. By default, this parameter is set to on and 5% over and under range is allowed for all analog output channels.

- In the Main Menu, choose Instrument Controls > I/O Configuration > Analog Output Config > **Allow Over/Under Range.**

```
ALLOW OVER/UNDER RANGE:  
CURRENTLY:          ON  
SET TO:             OFF  ?  
← TOGGLE VALUE  
RANGE  AVG  DIAGS  ALARM
```

Analog Output Configuration (Select Action)

The Analog Output Configuration menu displays a list of the analog output configuration choices, from which the user selects the parameter to adjust for the selected output channel. Configuration choices include selecting range, setting minimum/maximum values, and choosing the signal to output.

Note The settings are different depending on the AUTO/MANUAL MODE and RANGE MODE settings. Changing either of these settings will produce a different set of analog output data items. If either of these modes is going to be changed on a regular basis, then the user must configure each set of data separately after changing the modes to each setting. ▲

- In the Main Menu, choose Instrument Controls > I/O Configuration > Analog Output Config > **All Voltage Channels, All Current Channels, Voltage Channel 1–6 or Current Channel 1–6.**

```

ANALOG OUTPUT CONFIG:
>SELECT RANGE
SET MINIMUM VALUE
SET MAXIMUM VALUE
CHOOSE SIGNAL TO OUTPUT

RANGE  AVG  DIAGS  ALARM
  
```

Select Range

The Select Range screen is used to select the hardware range for the selected analog output channel. Possible ranges for the voltage outputs are: 0-100 mV, 0-1, 0-5, and 0-10 V. Possible ranges for the current outputs are: 0-20 mA and 4-20 mA.

- In the Main Menu, choose Instrument Controls > I/O Configuration > Analog Output Config > select Channel > **Select Range.**

```

SELECT OUTPUT RANGE:
SELECTED OUTPUT:    V ALL
CURRENTLY:          0-10V
SET TO:             0-100mV ?

↑↓ CHANGE VALUE    ← SAVE

RANGE  AVG  DIAGS  ALARM
  
```

Minimum and Maximum Value

The Minimum and Maximum Value screens are used to edit the zero (0) and full-scale (100) values, respectively, in percentages for the selected analog output channel. See [Table 3–6](#) for a list of choices. In dual or autorange mode, “HI” or “LO” is displayed to indicate high or low concentrations. Range Status is visible only in auto range mode. The O₂ conc items are only displayed if the internal O₂ sensor option is installed. The minimum and maximum output value screens function the same way. The following example shows the set minimum value screen.

- In the Main Menu, choose Instrument Controls > IO Configuration > Analog Output Config > select Channel > **Set Minimum or Maximum Value.**

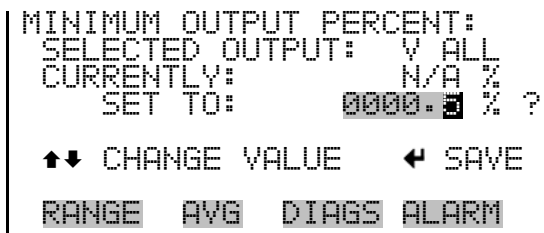

Table 3–6. Analog Output Zero to Full-Scale Table

Output	Zero % Value	Full-Scale 100% Value
CO	Zero (0)	
LO CO	Zero (0)	
HI CO	Zero (0)	
Range Status	Recommend not to change the setting for this output	
Sample/Reference Ratio	0.0	1.2
LO Sample/Reference Ratio	0.0	1.2
HI Sample/Reference Ratio	0.0	1.2
Internal Temperature	User-set alarm min value	User-set alarm max value
Bench Temperature	User-set alarm min value	User-set alarm max value
Pressure	User-set alarm min value	User-set alarm max value
Sample Flow	User-set alarm min value	User-set alarm max value
Intensity	User-set alarm min value	User-set alarm max value
Motor Speed	User-set alarm min value	User-set alarm max value
Bias Voltage	User-set alarm min value	User-set alarm max value
O ₂ %	Zero (0)	100 % O ₂
O ₂ Sensor Temp	Zero (0)	100 Degrees C
Everything Else	0 Units	10 Units

Choose Signal to Output

The Choose Signal to Output screen displays a submenu list of the analog output signal group choices. Group choices are Concentrations, Corrected Concentrations (if the O₂ compensation option is enabled), Other Measurements, and Analog Inputs (if the I/O expansion board option is installed). This allows the user to select the output signal to the selected output channel. In dual or auto range mode, “HI” or “LO” is displayed to indicate high or low concentrations. Range Status is visible only in auto range mode. The Concentrations screen is shown below. See [Table 3–7](#) below for a list of items for each signal group choice.

- In the Main Menu, choose Instrument Controls > I/O Configuration > Analog Output Config > select Channel > **Choose Signal To Output**.

```

CHOOSE SIGNAL TYPE:
>CONCENTRATIONS
CORRECTED CONCENTRATIONS
OTHER MEASUREMENTS
ANALOG INPUTS

RANGE  AVG  DIAGS  ALARM
    
```

```

CHOOSE SIGNAL -      CONC
SELECTED OUTPUT:      V1
CURRENTLY: CO
SET TO: NONE          ?

↑↓ CHANGE VALUE      ← SAVE

RANGE  AVG  DIAGS  ALARM
    
```

Table 3–7. Signal Type Group Choices

Concentrations	Corrected Concentrations	Other Measurements	Analog Inputs
None	None	None	None
CO (single/auto range only)	CO COR (single/auto range only)	Sample/Reference	Analog Input 1 (if the I/O expansion board is installed)
LO CO (dual range only)	LO CO COR (dual range only)	LO Sample/Reference	Analog Input 2 (if the I/O expansion board is installed)
HI CO (dual range only)	HI CO COR (dual range only)	HI Sample/Reference	Analog Input 3 (if the I/O expansion board is installed)
Range Status (auto range only)		Internal Temperature	Analog Input 4 (if the I/O expansion board is installed)
O ₂ %		Bench Temperature	Analog Input 5 (if the I/O expansion board is installed)
		Bench Pressure	Analog Input 6 (if the I/O expansion board is installed)
		Sample Flow	Analog Input 7 (if the I/O expansion board is installed)
		Intensity	Analog Input 8 (if the I/O expansion board is installed)
		Motor Speed	
		Bias Supply	
		Ext Alarms	

Concentrations	Corrected Concentrations	Other Measurements	Analog Inputs
O ₂ Sensor Temp			

Analog Input Configuration

The Analog Input Configuration menu displays a list of the 8 analog input channels available for configuration. This screen is only displayed if the I/O expansion board option is installed. Configuration includes entering the Descriptor, Units, Decimal Places, choice of 1-10 points in the table, and corresponding number of points selected.

- In the Main Menu, choose Instrument Controls > I/O Configuration > **Analog Input Config.**

```

ANALOG INPUT CONFIG:
>CHANNEL 1          IN1
CHANNEL 2          IN2
CHANNEL 3          IN3
CHANNEL 4          IN4
CHANNEL 5          IN5 ↓
RANGE  AVG  DIAGS  ALARM
    
```

```

ANALOG INPUT 01 CONFIG:
>DESCRIPTOR          IN1
UNITS                0
DECIMAL PLACES      2
TABLE POINTS        2
POINT 1              ↓
RANGE  AVG  DIAGS  ALARM
    
```

POINT 2

Descriptor

The Descriptor screen allows the user to enter the descriptor, or name, for the selected analog input channel. The descriptor is used in datalogging and streaming data to report what data is being sent out. The descriptor may be from 1 to 3 characters in length, and defaults to IN1 to IN8 (user input channel number).

- In the Main Menu, choose Instrument Controls > I/O Configuration > Analog Input Config > select Channel > **Descriptor.**



Units The Units screen allows the user to enter the units for the selected analog input channel. The units are displayed on the diagnostic screen and in datalogging and streaming data. The units may be from 1 to 3 characters in length, and defaults to V (volts).

- In the Main Menu, choose Instrument Controls > I/O Configuration > Analog Input Config > select Channel > **Units**.

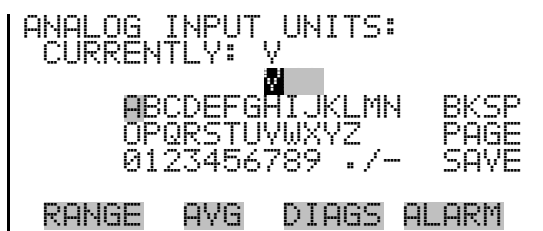

Decimal Places The Decimal Places screen allows the user to select how many digits are displayed to the right of the decimal, from 0 to 6, with a default of 2.

- In the Main Menu, choose Instrument Controls > I/O Configuration > Analog Input Config > Select Channel > **Decimal Places**.

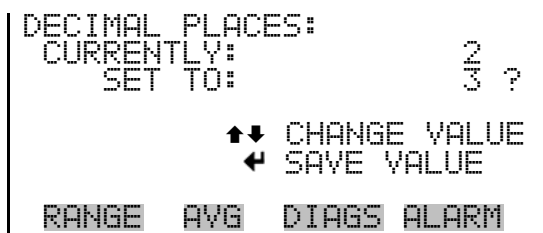

Number of Table Points The Number of Table Points screen allows the user to select how many points are used in the analog input conversion table for the selected channel. The instrument uses linear interpolation between the points in this table to determine what the reading value is based on the analog input voltage. Each point in the table consists of an analog input voltage value (0–10.5 V) and a corresponding reading value. Only two points are

necessary for linear inputs, however a larger number of points may be used to approximate non-linear inputs. The points range from 2 to 10, with a default of 2.

- In the Main Menu, choose Instrument Controls > I/O Configuration > Analog Input Config > select Channel > **Table Points**.

```
NUMBER OF TABLE POINTS:
CURRENTLY:                2
SET TO:                   10 ?
                           ↑↓ CHANGE VALUE
                           ← SAVE VALUE
RANGE  AVG  DIAGS  ALARM
```

Table Point The Table Point submenu allows the user to set up an individual table point.

- In the Main Menu, choose Instrument Controls > I/O Configuration > Analog Input Config > Select Channel > **Point 1-10**.

```
TABLE POINT 01 CONFIG:
>VOLTS                   0.00
USER VALUE                0.00
RANGE  AVG  DIAGS  ALARM
```

Volts The Volts screen allows the user to set the input voltage for the selected table point in the conversion table, from 0.00 to 10.50. The default table is a two-point table with point 1: 0.00 V = 000.0 U and point 2: 10.00 V = 10.0 U, where U is the previously entered unit of measure.

- In the Main Menu, choose Instrument Controls > I/O Configuration > Analog Input Config > select Channel > select Point > **Volts**.

```
TABLE POINT 01 VOLTS:
CURRENTLY:                0.00
SET TO:                   00.00
                           ↔ MOVE CURSOR
                           ↑↓ CHANGE VALUE ← SAVE
RANGE  AVG  DIAGS  ALARM
```

User Value The User Value screen allows the user to set the output value for the corresponding input voltage for the selected table point in the conversion table, from -9999999 to 99999999. The default table is a two-point table with point 1: 0.00 V = 000.0 U and point 2: 10.00 V = 10.0 U, where U is the previously entered unit of measure.

- In the Main Menu, choose Instrument Controls > I/O Configuration > Analog Input Config > select Channel > select Point > **User Value**.

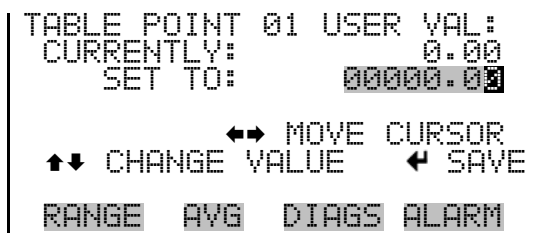

Temperature Compensation

Temperature compensation provides compensation for any changes to the instrument's output signal due to internal instrument temperature variations. The effects of internal instrument temperature changes on the analyzer's subsystems and output have been empirically determined. This empirical data is used to compensate for any changes in temperature. This compensation can be used for special applications, or when operating the instrument outside the recommended temperature range, even though the Model 48i does not require temperature compensation for EPA equivalency.

When temperature compensation is on, the display shows the current internal instrument temperature (measured by a thermistor on the Interface board). When temperature compensation is off, the display shows the factory standard temperature of 25 °C.

- In the Main Menu, choose Instrument Controls > **Temperature Compensation**.

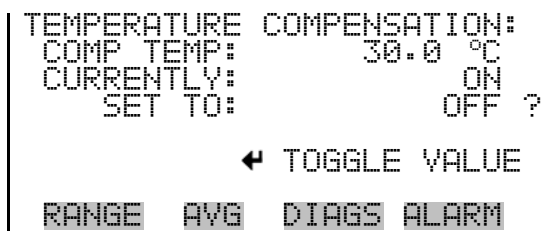

Pressure Compensation

Pressure compensation provides compensation for any changes to the instrument's output signal due to reaction chamber pressure variations. The effects of reaction chamber pressure changes on the analyzer's subsystems and output have been empirically determined. This empirical data is used to compensate for any change in chamber pressure.

When pressure compensation is on, the first line of the display represents the current pressure in the fluorescence chamber. When pressure compensation is off, the first line of the display shows the factory standard pressure of 750 mmHg.

- In the Main Menu, choose Instrument Controls > **Pressure Compensation**.

```
PRESSURE COMPENSATION:
COMP PRES:      750.0 mmHg
CURRENTLY:      ON
SET TO:         OFF ?
               ← TOGGLE VALUE
RANGE  AVG  DIAGS  ALARM
```

O₂ Compensation

The O₂ Compensation screen is used to turn oxygen compensation on or off. When O₂ compensation is enabled, the following equation is applied to the concentration value to generate a corrected value (CO COR). The corrected value may be output on the analog outputs, stored in logging memory, or output as streaming data. The corrected values are not displayed on the Run screen on the front panel, only the non-corrected values:

$$C_{comp} @ O2_{corr} = C * \left(\frac{20.9 - O2_{corr}}{20.9 - O2_{meas}} \right)$$

Abbreviations: C is the measured concentration, O_{2,corr} is the oxygen concentration that C is corrected to (this value is set by the user in the SERVICE > O₂ CORRECTION CONC menu and defaults to 15%). O_{2,meas} is the measured O₂ concentration, which is clamped at 20.8% to prevent divide-by-zero errors. C_{comp} is the corrected concentration (CO COR) that may be used for analog outputs or datalogging.

The O₂ CONC line shows the measured O₂ concentration if the compensation is on or the correction O₂ concentration if it is off.

- In the Main Menu, choose > Instrument Controls > **O2 Compensation**.

```

O2 COMPENSATION:
O2 CONC:      15.02 %
CURRENTLY:    ON
SET TO:       OFF ?
              ← TOGGLE VALUE
RANGE  AVG  DIAGS  ALARM
  
```

Screen Contrast

The Screen Contrast screen is used to change the contrast of the display. Intensities between 0 and 100% in increments of 5 are available. Changing the screen contrast may be necessary if the instrument is operated at extreme temperatures.

Note The optimal contrast will change with changes in temperature. ▲

Note The optimal contrast will change from one LCD to another. If the LCD is replaced, the contrast may need to be reset. ▲

Note If the display contrast is not optimal, but the content on the screen is visible, select Instrument Controls > **Screen Contrast** and adjust the screen contrast. If the content on the screen is not visible, use the “set contrast 10” C-Link command to set the screen contrast to mid-range, then optimize the contrast. See “contrast levels” in Appendix B, “[C-Link Protocol Commands](#)” for more information on this command. ▲

- In the Main Menu, choose Instrument Controls > **Screen Contrast**.

```

SCREEN CONTRAST:
CURRENTLY:      50 %
SET TO:        80 % ?
              ↑↓ CHANGE VALUE
              ← SAVE VALUE
RANGE  AVG  DIAGS  ALARM
  
```

Service Mode

The Service Mode screen is used to turn the service mode on or off. Turning service mode “ON” locks out any remote actions and allows access to parameters and functions that are useful when making adjustments or

diagnosing the Model 48*i*. The service (wrench) icon on the status bar is shown when service mode is on. For more information about the service mode, see “Service Menu” later in this chapter.

Note The service mode should be turned off when finished, as it prevents remote operation. ▲

- In the Main Menu, choose Instrument Controls > **Service Mode**.

```
SERVICE MODE:
CURRENTLY:      OFF
SET TO:         ON ?

      ← TOGGLE VALUE

RANGE  AVG  DIAGS  ALARM
```

Date/Time The Date/Time screen allows the user to view and change the system date and time (24-hour format). The internal clock is powered by its own battery when instrument power is off.

- In the Main Menu, choose Instrument Controls > **Date/Time**.

```
DATE AND TIME:
19 MAR 2009 12:34:56
PRESS ← TO EDIT

RANGE  AVG  DIAGS  ALARM
```

```
DATE AND TIME:
19 MAR 2009 12:34:56 ?
SETTING: DAYS
  → SET MONTHS
  ↑↓ CHANGE VALUE
  ← SAVE VALUE

RANGE  AVG  DIAGS  ALARM
```

Timezone The Timezone screen is used to set the timezone for the Network Time Protocol (NTP) server. This should be set to the timezone that the instrument is located in. If the exact timezone is not shown in the list, it may be entered via the C-LINK “tz” command (see Appendix B). The selections are: UTC (GMT), EST (GMT+5), CST (GMT+6), MST (GMT+7), PST (GMT+8), YST (GMT+9), HST (GMT+10), NST (GMT+11), DLW (GMT+12), CET (GMT-1), EET (GMT-2), BST (GMT-3), DLT (GMT-4), ECH (GMT-5), FOX (GMT-6), GLF (GMT-7), CCT (GMT-8), JST (GMT-9), GST (GMT-10), LMA (GMT-11), DLE (GMT-12), EDT (GMT+5/4), CDT (GMT+6/5), MDT (GMT+7/6), and PDT (GMT+8/7).

Note The current timezone may say NULL before the timezone is set for the first time, or if the timezone was cleared with a C-Link command. ▲

- In the Main Menu, choose Instrument Controls > **Timezone**.

```

TIMEZONE FOR TIMESERVER:
CURRENTLY: UTC (GMT)
SET TO: EST (GMT+5) ?

      ↑↓ CHANGE VALUE
      ← SAVE VALUE

RANGE  AVG  DIAGS  ALARM
  
```

Diagnostics Menu

The Diagnostics menu provides access to diagnostic information and functions. This menu is useful when troubleshooting the instrument. The analog input readings and analog input voltages are only displayed if the I/O expansion board option is installed. The O₂ Sensor Readings screen is only displayed if the internal O₂ sensor option is installed.

- In the Main Menu, choose **Diagnostics**.

```

DIAGNOSTICS:
>PROGRAM VERSIONS
VOLTAGES
TEMPERATURES
PRESSURE
FLOW
                                     ↓

RANGE  AVG  DIAGS  ALARM
  
```

```

SAMPLE/REF RATIO
AGC INTENSITY
MOTOR SPEED
O2 SENSOR READINGS
ANALOG INPUT READINGS
ANALOG INPUT VOLTAGES
DIGITAL INPUTS
RELAY STATES
TEST ANALOG OUTPUTS
INSTRUMENT CONFIGURATION
CONTACT INFORMATION
  
```

Program Versions

The Program Versions screen (read only) shows the version number of the programs installed. Prior to contacting the factory with any questions regarding the instrument, please note the product model name and the program version numbers.

- In the Main Menu, choose Diagnostics > **Program Versions**.

```
PROGRAM VERSIONS:
  PRODUCT:      MODEL 48i
  VERSION:     01.06.08.248
  FIRMWARE:    11.08.105

RANGE  AVG  DIAGS  ALARM
```

Voltages

The Voltages menu displays the current diagnostic voltage readings. This screen enables the power supply to be quickly read for low or fluctuating voltages without having to use a voltage meter. The I/O board is only displayed if the I/O expansion board option is installed.

- In the Main Menu, choose Diagnostics > **Voltages**.

```
VOLTAGES:
>MOTHERBOARD
INTERFACE BOARD
I/O BOARD

RANGE  AVG  DIAGS  ALARM
```

Motherboard Voltages

The Motherboard screen (read only) is used to display the current voltage readings on the motherboard.

- In the Main Menu, choose Diagnostics > Voltages > **Motherboard Voltages**.

```
MOTHERBOARD VOLTAGES:
  3.3 SUPPLY          3.3 V
  5.0 SUPPLY          5.0 V
 15.0 SUPPLY         15.0 V
 24.0 SUPPLY         24.1 V
 -3.3 SUPPLY         -3.3 V

RANGE  AVG  DIAGS  ALARM
```

Interface Board Voltages

The Interface Board screen (read only) is used to display the current voltage readings on the interface board. This menu is only displayed if the I/O expansion board option is installed.

- In the Main Menu, choose Diagnostics > Voltages > **Interface Board Voltages**.

```

INTERFACE BOARD VOLTAGES:
> 3.3 SUPPLY          3.3 V
  5.0 SUPPLY          5.0 V
 15.0 SUPPLY          15.0 V
 24.0 SUPPLY          24.1 V
-15.0 SUPPLY          -15.0 V↓

RANGE  AVG  DIAGS  ALARM

18.0 IR SUPPLY        18.0 V
18.0 NOT SUPPLY       18.0 V
BIAS SUPPLY           -110.0 V
  
```

I/O Board Voltages

The I/O Board screen (read only) is used to display the current voltage readings on the I/O expansion board. This menu is only displayed if the I/O expansion board option is installed.

- In the Main Menu, choose Diagnostics > Voltages > **I/O Board Voltages**.

```

I/O BOARD VOLTAGES:
 3.3 SUPPLY          3.3 V
  5.0 SUPPLY          5.0 V
 24.0 SUPPLY          24.0 V
 -3.3 SUPPLY          -3.3 V

RANGE  AVG  DIAGS  ALARM
  
```

Temperatures

The Temperatures screen (read only) displays the current internal instrument temperature and bench temperature. The internal temperature is the air temperature measured by a sensor located on the interface board.

- In the Main Menu, choose Diagnostics > **Temperatures**.

```

TEMPERATURES:
INTERNAL          34.6 °C
BENCH             49.7 °C

RANGE  AVG  DIAGS  ALARM
  
```

Pressure

The Pressure screen (read only) displays the current optical bench pressure. The pressure is measured by a pressure transducer.

- In the Main Menu, choose Diagnostics > **Pressure**.

```
PRESSURE:          753.0 mmHg  
  
RANGE  AVG  DIAGS  ALARM
```

Flow The Flow screen (read only) displays the flow rate. The flow is measured by an internal flow sensor. For more information, see Chapter 1, “Introduction”.

- In the Main Menu, choose Diagnostics > **Flow**.

```
FLOW:              1.108 L/min  
  
RANGE  AVG  DIAGS  ALARM
```

Sample/Reference Ratio

The Sample/Reference Ratio screen (read only) displays the ratio of the intensities of the light source through the sample wavelength and reference wavelength of the bandpass filter wheel. Normally, when zero air is being sampled, the sample/reference ratio is between 1.14 and 1.18. A ratio outside may indicate that the filter wheel is dirty or the infrared source is degraded.

- In the Main Menu, choose Diagnostics > **Sample/Ref Ratio**.

```
SAMPLE REFERENCE RATIO:  
S/R:                1.161111  
  
RANGE  AVG  DIAGS  ALARM
```

AGC Intensity

The AGC Intensity screen (read only) displays the intensity (in Hertz) of the reference channel Automatic Gain Control (AGC) circuit. The AGC circuit optimizes the noise and resolution levels of the Model 48*i*. The AGC intensity reading should be about 250,000 Hertz.

- In the Main Menu, choose Diagnostics > **AGC Intensity**.

```

AGC INTENSITY:
INTENSITY:      250000 Hz

RANGE  AVG  DIAGS  ALARM
  
```

Motor Speed

The Motor Speed screen (read only) displays the status of the chopper motor. A reading of 100.0% means that the motor speed is correct. A reading other than 100.0% indicates that there is a problem with the chopper motor or power supply.

- In the Main Menu, choose Diagnostics > **Motor Speed**.

```

MOTOR SPEED:
SPEED:          100.00 %

RANGE  AVG  DIAGS  ALARM
  
```

O₂ Sensor Readings

The O₂ Sensor Readings screen (read only) displays the measured oxygen concentration (in percent) and the oxygen sensor temperature (in degrees C). This screen is only visible if the internal O₂ sensor option is installed.

- In the Main Menu, choose > Diagnostics > **O₂ Sensor Readings**.

```

O2 CONC:        15.02 %
TEMP:           30.2 °C

RANGE  AVG  DIAGS  ALARM
  
```

Analog Input Readings

The Analog Input Readings screen (read only) displays the 8 current user-scaled analog readings (if the I/O expansion board option is installed).

- In the Main Menu, choose Diagnostics > **Analog Input Readings**.

```
ANALOG INPUT READINGS:
>NO          10.2 ppm
NO2          18.2 ppb
CO2          250 ppm
FL1          20.42 L/min
IO7          0.0 V↓
RANGE  AVG  DIAGS  ALARM
```

Analog Input Voltages

The Analog Input Voltages screen (read only) displays the 8 raw analog voltage readings (if the I/O expansion board option is installed).

- In the Main Menu, choose Diagnostics > **Analog Input Voltages**.

```
ANALOG INPUT VOLTAGES:
>ANALOG IN 1      6.24 V
ANALOG IN 2      4.28 V
ANALOG IN 3      0.00 V
ANALOG IN 4      0.00 V
ANALOG IN 5      0.00 V↓
RANGE  AVG  DIAGS  ALARM
```

Digital Inputs

The Digital Inputs screen (read only) displays the state of the 16 digital inputs. Pull-ups are provided on all of the inputs, so if nothing is connected they will read (1), if an input is brought to ground, it will read (0).

- In the Main Menu, choose Diagnostics > **Digital Inputs**.

```
DIGITAL INPUTS:
>INPUT 1          1
INPUT 2          1
INPUT 3          1
INPUT 4          1
INPUT 5          1↓
RANGE  AVG  DIAGS  ALARM
```

Relay States

The Relay States screen displays the state of the 10 digital outputs and allows toggling of the state to either on (1) or off (0). The relays are restored to their original states upon exiting this screen.

- In the Main Menu, choose Diagnostics > **Relay States**.
- Press  to toggle and set the relay state to open or closed for the selected digital output.

```
RELAY STATE:
>OUTPUT 1      0
OUTPUT 2      0
OUTPUT 3      0
OUTPUT 4      1
OUTPUT 5      1
RANGE  AVG  DIAGS  ALARM
```

Test Analog Outputs

The Test Analog Outputs menu is used to set each of the analog output channels to zero or full-scale. Channel choices include all analog outputs, 6 voltage channels, and 6 current channels (if the I/O expansion board option is installed).

- In the Main Menu, choose Diagnostics > **Test Analog Outputs**.

```
TEST ANALOG OUTPUTS:
>ALL
VOLTAGE CHANNEL 1
VOLTAGE CHANNEL 2
VOLTAGE CHANNEL 3
VOLTAGE CHANNEL 4
RANGE  AVG  DIAGS  ALARM
```

Set Analog Outputs

The Set Analog Outputs screen contains three choices: Set to full-scale, set to zero, or reset to normal. Full-scale sets the analog outputs to the full-scale voltage, zero sets the analog outputs to 0 volts, and reset returns the output to normal operation. The analog outputs are returned to normal operation upon exiting this screen. The following example shows the screen when all analog outputs are set to “normal” operating mode.

- In the Main Menu, choose Diagnostics > Test Analog Outputs > **ALL, Voltage Channel 1–6, or Current Channel 1–6**.

```
SET ANALOG OUTPUTS:
SETTING:          ALL
OUTPUT SET TO:   NORMAL
↑ SET TO FULL SCALE
↓ SET TO ZERO
← RESET TO NORMAL
RANGE  AVG  DIAGS  ALARM
```

Instrument Configuration

The Instrument Configuration screen displays information on the hardware configuration of the instrument.

Note If the analyzer is in service mode, pressing  will toggle the selected item between yes and no (with the exception of dilution ratio and auto calibration, which may be only enabled at the factory). ▲

- In the Main Menu, choose Diagnostics > **Instrument Configuration**.

```
INSTRUMENT CONFIGURATION:
>I/O EXPANSION BOARD  YES
ZERO/SPAN VALVES      YES
ZERO AIR SCRUBBER     YES
WHEEL PURGE           YES
DILUTION               NO↓
RANGE  AVG  DIAGS  ALARM
AUTO CALIBRATION      NO
O2 SENSOR              YES
```

Contact Information

The Contact Information screen displays the customer service information.

- In the Main Menu, choose Diagnostics > **Contact Information**.

```
CONTACT INFORMATION:
CALL CENTER: 508-520-0430
WEB:          WWW.THERMO.COM
RANGE  AVG  DIAGS  ALARM
```

Alarms Menu

The Alarms menu displays a list of items that are monitored by the analyzer. If the item being monitored goes outside the lower or upper limit, the status of that item will go from “OK” to either “LOW” or “HIGH”, respectively. If the alarm is not a level alarm, the status will go from “OK” to “FAIL”. The number of alarms detected is displayed to indicate how many alarms have occurred. If no alarms are detected, the number zero is displayed.

To see the actual reading of an item and its minimum and maximum limits, move the cursor to the item and press .

Items displayed are determined by the options installed. The zero/span check and auto calibration screens are visible only if the zero/span check or auto calibration options are enabled. The O₂ Concentration Alarm menu item is only displayed if the internal O₂ sensor option is installed. The motherboard status, interface board status, and I/O Expansion board status

(if installed) indicate that the power supplies are working and connections are successful. There are no setting screens for these alarms.

- In the Main Menu, choose **Alarms**.

```

ALARMS:
ALARMS DETECTED          0
>INTERNAL TEMP           OK
BENCH TEMP               OK
PRESSURE                 OK
SAMPLE FLOW              OK↓

RANGE  AVG  DIAGS  ALARM

BIAS VOLTAGE             OK
AGC INTENSITY            OK
MOTOR SPEED              OK
ZERO CHECK               OK
SPAN CHECK               OK
ZERO AUTOCAL             OK
SPAN AUTOCAL             OK
CONCENTRATION            OK
O2 CONCENTRATION        OK
EXTERNAL ALARMS         OK
MOTHERBOARD STATUS      OK
INTERFACE STATUS         OK
I/O EXP STATUS           OK
  
```

Internal Temperature

The Internal Temperature screen displays the current internal temperature and sets the minimum and maximum alarm limits. Acceptable alarm limits range from 8 to 47 °C. If the internal temperature reading goes beyond either the minimum or maximum limit, an alarm is activated and the alarm (bell) icon appears in the status bar on the Run screen and in the Main Menu.

- In the Main Menu, choose Alarms > **Internal Temp**.

```

INTERNAL TEMPERATURE:
ACTUAL                30.1 °C
>MIN                  8.0 °C
MAX                   47.0 °C

RANGE  AVG  DIAGS  ALARM
  
```

Min and Max Internal Temperature Limits

The Minimum Internal Temperature alarm limit screen is used to change the minimum internal temperature alarm limit. The minimum and maximum internal temperature screens function the same way.

- In the Main Menu, choose Alarms > Internal Temp > **Min** or **Max**.

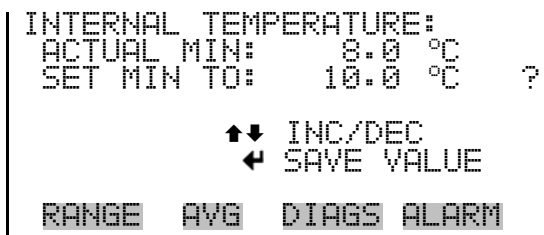

Bench Temperature

The Bench Temperature screen displays the current bench temperature and sets the minimum and maximum alarm limits. Acceptable alarm limits range from 40 to 59 °C. If the bench temperature reading goes beyond either the minimum or maximum limit, an alarm is activated and the alarm (bell) icon appears in the status bar on the Run screen and in the Main Menu.

- In the Main Menu, choose Alarms > **Bench Temp**.

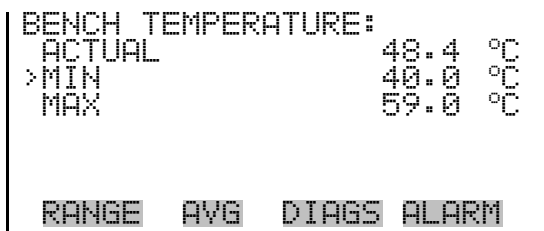

Min and Max Bench Temperature Limits

The Minimum Bench Temperature alarm limit screen is used to change the minimum bench temperature alarm limit. The minimum and maximum bench temperature screens function the same way.

- In the Main Menu, choose Alarms > Bench Temp > **Min** or **Max**.

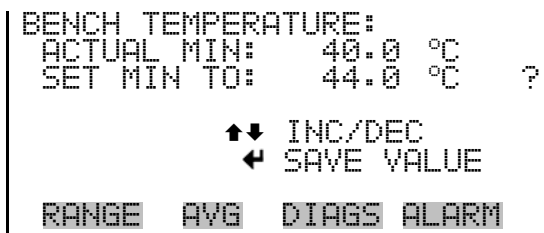

Pressure

The Pressure screen displays the current reaction chamber pressure reading and sets the minimum and maximum alarm limits. Acceptable alarm limits range from 250 to 1,000 mmHg. If the pressure reading goes beyond either

the minimum or maximum limit, an alarm is activated and the alarm (bell) icon appears in the status bar on the Run screen and in the Main Menu.

- In the Main Menu, choose Alarms > **Pressure**.

```

PRESSURE:
ACTUAL          746.9 mmHg
>MIN            250.0 mmHg
MAX             1000.0 mmHg

RANGE  AVG  DIAGS  ALARM
  
```

Min and Max Pressure Limits

The Minimum Pressure alarm limit screen is used to change the minimum pressure alarm limit. The minimum and maximum pressure screens function the same way.

- In the Main Menu, choose Alarms > Pressure > **Min** or **Max**.

```

PRESSURE:
ACTUAL MIN:    246.0 mmHg
SET MIN TO:    500.0 mmHg ?

      ↑↓ INC/DEC
      ← SAVE VALUE

RANGE  AVG  DIAGS  ALARM
  
```

Sample Flow

The Sample Flow screen displays the current sample flow reading and sets the minimum and maximum alarm limits. Acceptable alarm limits range from .350 to 1.500 L/min. If the sample flow reading goes beyond either the minimum or maximum limit, an alarm is activated and the alarm (bell) icon appears in the status bar on the Run screen and in the Main Menu.

- In the Main Menu, choose Alarms > **Sample Flow**.

```

SAMPLE FLOW:
ACTUAL          0.750 L/min
>MIN            0.350 L/min
MAX             1.500 L/min

RANGE  AVG  DIAGS  ALARM
  
```

Min and Max Sample Flow Limits

The Minimum Sample Flow alarm limit screen is used to change the minimum sample flow alarm limit. The minimum and maximum sample flow screens function the same way.

- In the Main Menu, choose Alarms > Sample Flow > **Min** or **Max**.

```
SAMPLE FLOW:
ACTUAL MIN: 0.350 L/min
SET MIN TO: 0.500 L/min ?

  ↑↓ INC/DEC
  ← SAVE VALUE

RANGE  AVG  DIAGS  ALARM
```

Bias Voltage

The Bias Voltage screen displays the current bias voltage reading and sets the minimum and maximum alarm limits. Acceptable alarm limits range from -130 to -100 volts. If the bias voltage reading goes beyond either the minimum or maximum limit, an alarm is activated and the alarm (bell) icon appears in the status bar on the Run screen and in the Main Menu.

- In the Main Menu, choose Alarms > **Bias Voltage**.

```
BIAS VOLTAGE:
ACTUAL          -110 V
>MIN           -130 V
MAX            -100 V

RANGE  AVG  DIAGS  ALARM
```

Min and Max Bias Voltage Limits

The Minimum Bias Voltage alarm limit screen is used to change the minimum bias voltage alarm limit. The minimum and maximum bias voltage screens function the same way.

- In the Main Menu, choose Alarms > Bias Voltage > **Min** or **Max**.

```
BIAS VOLTAGE:
ACTUAL MIN: -130 V
SET MIN TO: -120 V      ?

  ↑↓ INC/DEC
  ← SAVE VALUE

RANGE  AVG  DIAGS  ALARM
```

AGC Intensity

The AGC Intensity screen displays the current AGC Intensity reading and sets the minimum and maximum alarm limits. Acceptable alarm limits range from 150,000 to 300,000 Hz. If the AGC intensity reading goes beyond either the minimum or maximum limit, an alarm is activated and the alarm (bell) icon appears in the status bar on the Run screen and in the Main Menu.

- In the Main Menu, choose Alarms > **AGC Intensity**.

```

AGC INTENSITY:
  ACTUAL          196646 Hz
>MIN             150000 Hz
  MAX            300000 Hz

RANGE  AVG  DIAGS  ALARM
  
```

Min and Max AGC Intensity Limits

The Minimum AGC Intensity alarm limit screen is used to change the minimum AGC intensity alarm limit. The minimum and maximum AGC Intensity screens function the same way.

- In the Main Menu, choose Alarms > AGC Intensity > **Min** or **Max**.

```

AGC INTENSITY:
  ACTUAL MIN: 150000 Hz
  SET MIN TO: 200000 Hz   ?

      ↑↓ INC/DEC
      ← SAVE VALUE

RANGE  AVG  DIAGS  ALARM
  
```

Motor Speed

The Motor Speed screen (read only) displays the current motor speed. A reading other than 100.0% indicates a problem with either the motor or the power supply.

- In the Main Menu, choose Alarms > **Motor Speed**.

```
MOTOR SPEED:
ACTUAL                100.0 %

RANGE  AVG  DIAGS  ALARM
```

Zero and Span Check

The Zero and Span Check screens allow the user to view the status of the most recent zero/span checks and set the maximum check offsets. An alarm will be triggered if a zero or span check indicates drift that exceeds the offset value. The zero and span check screens are visible only if the zero/span check option is enabled. Their functions are similar.

- In the Main Menu, choose Alarms > **Zero** or **Span Check**.

```
ZERO CHECK:
ALARM:                OK
RESPONSE:             0.100
>MAX OFFSET:         .200

RANGE  AVG  DIAGS  ALARM
```

Max Zero and Span Offset

The Max Zero Check Offset screen is used to change the maximum zero check offset. The maximum zero and span offset screens function the same way.

- In the Main Menu, choose Alarms > Zero or Span Check > **Max Offset**.

```
MAX ZERO CHECK OFFSET:
CURRENTLY:             0.200
SET TO:               0000.000 ?

      ←→ MOVE CURSOR
↑↓ CHANGE VALUE      ← SAVE

RANGE  AVG  DIAGS  ALARM
```

Zero and Span Auto Calibration

The Zero and Span Auto Calibration screens (read only) allow the user to view the status of the most recent auto background calibration or span calibrations. The zero and span auto calibration screens are visible only if the zero/span check option is enabled and the zero or span cal reset function is enabled and the zero and span cal reset function is enabled.

- In the Main Menu, choose Alarms > **Zero** or **Span Autocal**.

```

ZERO AUTO CALIBRATION:
  ALARM:                OK
  RESPONSE:             0.200

RANGE  AVG  DIAGS  ALARM
  
```

Concentration

The Concentration screen displays the current CO concentration and sets the minimum and maximum alarm limits. Acceptable alarm limits range from 0 to 10000. The minimum alarm may be programmed as a floor trigger (alarm is triggered when the concentration falls below the minimum value) or a ceiling trigger (alarm is triggered when the concentration goes above the minimum value). If the CO concentration goes beyond either the minimum or maximum limit, an alarm is activated and the alarm (bell) icon appears in the status bar on the Run screen and in the Main Menu.

- In the Main Menu, choose Alarms > **Concentration**.

```

CONCENTRATION:
  ACTUAL                0.000
  >MIN                  10000
  MAX                   10000
  MIN TRIGGER           CEILING

RANGE  AVG  DIAGS  ALARM
  
```

Min and Max Concentration Limits

The Minimum Concentration alarm limit screen is used to change the minimum concentration alarm limits. The minimum and maximum concentration alarm limit screens function the same way.

- In the Main Menu, choose Alarms > Concentration > **Min** or **Max**.

```

CONCENTRATION:
  ACTUAL MIN:           10000
  SET MIN TO:          0100.000 ?

  ←↑ CHANGE VALUE      ↔ MOVE CURSOR
  ↓↑ CHANGE VALUE      ← SAVE

RANGE  AVG  DIAGS  ALARM
  
```

Min Trigger Concentration

The Minimum Trigger screen allows the user to view and set the concentration alarm trigger type to either floor or ceiling. The minimum alarm may be programmed as a floor trigger (alarm is triggered when the concentration falls below the minimum value) or a ceiling trigger (alarm is triggered when the concentration goes above the minimum value).

- In the Main Menu, choose Alarms > Select Concentration > **Min Trigger**.

```
MIN TRIG(CEILING/FLOOR):  
ACTUAL TRIGGER: CEILING  
SET TRIGGER TO: FLOOR ?  
  
← TOGGLE AND SAVE VALUE  
RANGE  AVG  DIAGS  ALARM
```

O₂ Concentration

The O₂ Concentration Alarm screen displays the current oxygen concentration and sets the minimum and maximum alarm limits. Acceptable alarm limits range from 0.00 to 100.00 % with defaults of 25.00% (minimum and maximum). If the O₂ concentration goes above either the minimum or maximum limit, an alarm is activated. This alarm is only visible if the internal O₂ sensor option is installed.

- In the Main Menu, choose Alarms > **O₂ Concentration**.

```
O2 CONCENTRATION:  
ACTUAL          15.02 %  
>MIN           25.00 %  
MAX            25.00 %  
MIN TRIGGER    CEILING  
  
RANGE  AVG  DIAGS  ALARM
```

Min and Max O₂ Concentration Limits

The Minimum O₂ Concentration alarm limit screen is used to change the minimum oxygen concentration alarm limit. The minimum and maximum O₂ concentration screens function the same way.

- In the Main Menu, choose Alarms > O₂ Concentration > **Min** or **Max**.

```

O2 CONCENTRATION:
ACTUAL MIN:      25.00 %
SET MIN TO:     10.00 % ?

      ↑↓ INC/DEC
      ← SAVE VALUE

RANGE  AVG  DIAGS  ALARM
  
```

Min Trigger

The Minimum Trigger screen allows the user to view and set the O₂ concentration alarm trigger type to either floor or ceiling. The minimum alarm may be programmed as a floor trigger (alarm is triggered when the concentration falls below the minimum value) or a ceiling trigger (alarm is triggered when the concentration goes above the minimum value).

- In the Main Menu, choose Alarms > O₂ Concentration > **Min Trigger**.

```

MIN TRIG<CEILING/FLOOR:
ACTUAL TRIGGER: CEILING
SET TRIGGER TO:   FLOOR ?

      ← TOGGLE AND SAVE VALUE

RANGE  AVG  DIAGS  ALARM
  
```

External Alarms

The External Alarms menu is used to display the external alarm status for alarm 1, 2, and 3 only if the external alarm is assigned as a digital input. External alarms can be assigned to digital inputs using the Instruments Controls > I/O Configuration > Digital Input Settings menu. External alarms can also be logged, streamed, or output as a digital output by choosing “EXT ALARMS” from the Other Measurements list.

- In the Main Menu, choose Alarms > **External Alarms**.

```

ALARMS:
EXTERNAL ALARM 1      OK
EXTERNAL ALARM 2      OK
EXTERNAL ALARM 3      OK

RANGE  AVG  DIAGS  ALARM
  
```

Service Menu

The Service menu appears only when the instrument is in the service mode. When service mode is active, the service (wrench) icon is displayed on the right side of the status bar. To put the instrument into the service mode, choose Instrument Controls > **Service Mode** in the Main Menu.

Advanced diagnostic functions are included in the service mode. Meaningful data should not be collected when the instrument is in the service mode. In dual or auto range modes, “HI” or “LO” multi-point calibration is displayed to indicate the calibration of the high or low concentrations. The O₂ Correction Concentration menu item is only displayed if the O₂ correction option is installed.

- In the Main Menu, choose **Service**.

```
SERVICE:
>RANGE MODE SELECT
PRESSURE CALIBRATION
FLOW CALIBRATION
INITIAL S/R RATIO
MULTIPOINT CAL
RANGE  AVG  DIAGS  ALARM
LO MULTIPOINT CAL
HI MULTIPOINT CAL
PREAMP BOARD CAL
TEMPERATURE CALIBRATION
ANALOG OUT CAL
ANALOG INPUT CAL
O2 CORRECTION CONC
DILUTION RATIO
SETUP RUN SCREENS
DISPLAY PIXEL TEST
RESTORE USER DEFAULTS
```

Range Mode Select

The Range Mode Select screen is used to switch between the various range modes: Single, Dual, and Auto Range. The range mode select screen is visible only when the instrument is in service mode. For more information on the service mode, see “[Service Mode](#)” earlier in this chapter.

- In the Main Menu, choose Service > **Range Mode Select**.

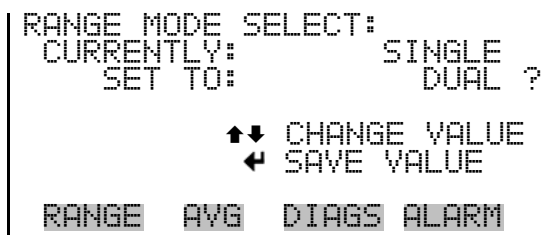

Pressure Calibration

The Pressure Calibration submenu is used to calibrate the pressure sensor to zero, span, or restore factory default values. The pressure calibration is visible only when the instrument is in service mode. For more information on the service mode, see “[Service Mode](#)” earlier in this chapter.

The pressure sensor’s zero counts and span slope are displayed on the menu.

Note This adjustment should only be performed by an instrument service technician. ▲

- In the Main Menu, choose Service > **Pressure Calibration**.

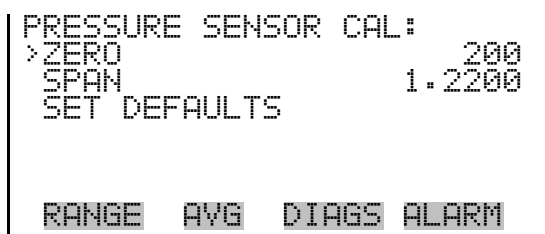

Calibrate Pressure Zero

The Calibrate Pressure Zero screen calibrates the pressure sensor at zero pressure.

Note A vacuum pump must be connected to the pressure sensor before performing the zero calibration. ▲

Note Wait at least 30 seconds for the reading to stabilize before saving the value. ▲

- In the Main Menu, choose Service > Pressure Calibration > **Zero**.

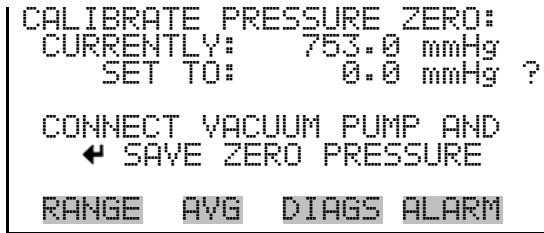

Calibrate Pressure Span

The Calibrate Pressure Span screen allows the user to view and set the pressure sensor calibration span point.

Note The plumbing going to the pressure sensor should be disconnected so the sensor is reading ambient pressure before performing the span calibration. The operator should use an independent barometer to measure the ambient pressure and enter the value on this screen before calibrating. ▲

Note Wait at least 30 seconds for the reading to stabilize before saving the value. ▲

- In the Main Menu, choose Service > Pressure Calibration > **Span**.

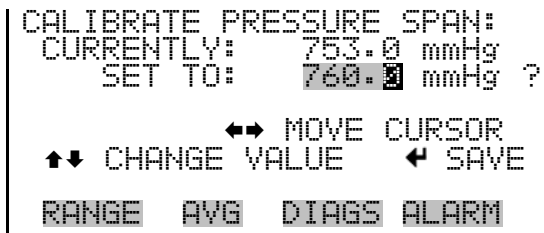

Restore Default Pressure Calibration

The Restore Default Pressure Calibration screen allows the user to reset the pressure calibration configuration values to factory defaults.

- In the Main Menu, choose Service > Pressure Calibration > **Set Defaults**.

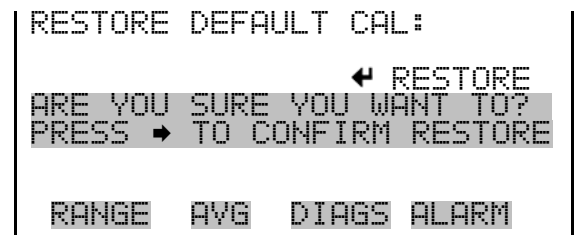
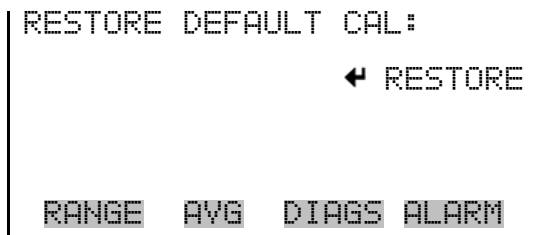

Flow Calibration

The Flow Calibration submenu is used to calibrate the flow sensor to zero, span, or restore factory default values. The flow calibration screen is visible only when the instrument is in service mode. For more information on the service mode, see “[Service Mode](#)” earlier in the chapter.

Note This adjustment should only be performed by an instrument service technician. ▲

- In the Main Menu, choose Service > **Flow Calibration**.

```

FLOW SENSOR CAL:
>ZERO           200
SPAN           1.0000
SET DEFAULTS

RANGE  AVG  DIAGS  ALARM
  
```

Calibrate Flow Zero

The Calibrate Flow Zero screen calibrates the flow sensor at zero flow.

Note The pump must be disconnected before performing the zero calibration. ▲

Note Wait at least 30 seconds for the reading to stabilize before saving the value. ▲

- In the Main Menu, choose Service > Flow Calibration > **Zero**.

```

CALIBRATE FLOW ZERO:
CURRENTLY:  0.000 L/min
SET TO:    0.000 L/min ?

DISCONNECT PUMP AND
← SAVE CURRENT FLOW

RANGE  AVG  DIAGS  ALARM
  
```

Calibrate Flow Span

The Calibrate Flow Span screen allows the user to view and set the flow sensor calibration span point.

Note An independent flow sensor is required to read the flow, then the operator enters the flow value on this screen to perform the calibration. ▲

Note Wait at least 30 seconds for the reading to stabilize before saving the value. ▲

- In the Main Menu, choose Service > Flow Calibration > **Span**.

```
CALIBRATE FLOW SPAN:
CURRENTLY:  0.800 L/min
SET TO:     0.750 L/min ?

      ←→ MOVE CURSOR
↑↓ CHANGE VALUE  ← SAVE

RANGE  AVG  DIAGS  ALARM
```

Restore Default Flow Calibration

The Restore Default Flow Calibration screen allows the user to reset the flow calibration configuration values to factory defaults.

- In the Main Menu, choose Service > Flow Calibration > **Set Defaults**.

```
RESTORE DEFAULT CAL:

      ← RESTORE

RANGE  AVG  DIAGS  ALARM
```

```
RESTORE DEFAULT CAL:

      ← RESTORE
ARE YOU SURE YOU WANT TO?
PRESS → TO CONFIRM RESTORE

RANGE  AVG  DIAGS  ALARM
```

Initial Sample/Reference Ratio

The Initial Sample/Reference (S/R) Ratio screen displays both the initial S/R ratio and the current S/R ratio. The initial S/R ratio is determined at the factory, and is used to correct for the slight variations found from one correlation wheel to another. The only time the initial S/R ratio should be changed is when the correlation wheel is replaced or sample/reference is between 1.14 and 1.18.

Note This adjustment should only be performed by an instrument service technician. ▲

- In the Main Menu, choose Service > **Initial S/R Ratio**.

```

INITIAL S/R RATIO:
CURRENTLY:      1.161111
MEASURED:      1.161111
SET TO:        1.162111 ?
               ← SAVE
               ←→ MOVE CURSOR
               ↑↓ CHANGE VALUE
RANGE  AVG  DIAGS  ALARM
  
```

Multi-Point Calibration

Up to three gas concentrations (cal-points) for each range may be calibrated to using the following steps. Three cal-points will give the most accurate readings over the entire range. The calibration process is sequential and will work properly if all steps are followed in order. The following example shows the multi-point calibration screen in single range mode. In dual or auto range modes, “HI” or “LO” is displayed to indicate the calibration of the high or low concentrations and function the same way.

Note This adjustment should only be performed by an instrument service technician. ▲

- In the Main Menu, choose Service > **Multipoint Calibration**.

```

MULTI-POINT CAL:
>CALIBRATE POINT 1
CALIBRATE POINT 2
CALIBRATE POINT 3
COEFFICIENTS
DEFAULT COEFFICIENTS
RANGE  AVG  DIAGS  ALARM
  
```

Calibrate Point 1/2/3

The Calibrate Point 1 screen allows the user to view and set the selected calibration point. The calibrate 2 and calibrate 3 screens function the same way.

- In the Main Menu, choose Service > Multipoint Cal > **Calibrate 1, 2 or 3**.

```
SET CAL GAS POINT:
RANGE: 10000
CAL FACTOR 1: 1.0000
CAL GAS 1: 0040.000 ?
      ←→ MOVE CURSOR
    ↑↓ CHANGE VALUE  ← SAVE
RANGE  AVG  DIAGS  ALARM
```

Coefficients The Coefficients screen allows the user to view and re-calculate the calibration coefficients.

- In the Main Menu, choose Service > Multipoint Cal > select Cal Point > **Coefficients**.

```
COEFFICIENTS:
  1: 1.00000
  2: 1.00000
  3: 1.00000
      ← RECALCULATE ?
RANGE  AVG  DIAGS  ALARM
```

Default Coefficients The Default Coefficients screen allows the user to view and reset the calibration coefficients to default values.

- In the Main Menu, choose Service > Multipoint Cal > select Cal Point > **Default Coefficients**.

```
COEFFICIENTS:
  1: 1.00000
  2: 1.00000
  3: 1.00000
      ← SET TO DEFAULTS ?
RANGE  AVG  DIAGS  ALARM
```

Preamp Board Calibration

The Pre-amp Board Calibration screen is used to adjust the preamp board calibration parameters. The preamp board calibration screen is visible only when the instrument is in service mode. For more information on the service mode, see “[Service Mode](#)” earlier in this chapter.

Note This adjustment should only be performed by an instrument service technician. ▲

- In the Main Menu, choose Service > **Preamp Calibration**.

```

PREAMP BOARD CAL:
SAMPLE:      127807 Hz
REFERENCE:   148256 Hz
SET TO:      128   ?
↑↓ CHANGE VALUE   ← SAVE
RANGE  AVG  DIAGS  ALARM
  
```

Temperature Calibration

The Temperature Calibration screen allows the user to view and set the ambient temperature sensor offset, which basically adjusts the temperature sensor so that it reads correctly. The temperature calibration is visible only when the instrument is in service mode. For more information on the service mode, see “[Service Mode](#)” earlier in the chapter.

Note This adjustment should only be performed by an instrument service technician. ▲

Note Wait at least 30 seconds for the reading to stabilize before saving the value. ▲

- In the Main Menu, choose Service > **Temperature Calibration**.

```

CALIBRATE AMBIENT TEMP:
CURRENTLY:      32.3 °C
SET TO:         032.0 °C ?
                ↔ MOVE CURSOR
↑↓ CHANGE VALUE   ← SAVE
RANGE  AVG  DIAGS  ALARM
  
```

Analog Output Calibration

The Analog Output Calibration menu provides access to the 6 voltage channels and 6 current channels for calibration. Current channels are visible only if the I/O expansion board is installed. The analog output calibration menu is visible only when the instrument is in service mode. For more information on the service mode, see “[Service Mode](#)” earlier in the chapter.

Note This adjustment should only be performed by an instrument service technician. ▲

- In the Main Menu, choose Service > **Analog Out Cal.**

```
ANALOG OUTPUT CAL:
>VOLTAGE CHANNEL 1
  VOLTAGE CHANNEL 2
  VOLTAGE CHANNEL 3
  VOLTAGE CHANNEL 4
  VOLTAGE CHANNEL 5
                                     ↓
RANGE  AVG  DIAGS  ALARM
```

```
ANALOG OUTPUT CAL:
>CALIBRATE ZERO
  CALIBRATE FULL SCALE
RANGE  AVG  DIAGS  ALARM
```

Analog Output Calibrate Zero

The Analog Output Calibrate Zero screen allows the user to calibrate the zero state of the selected analog output. The operator must connect a volt meter to the output and adjust the output until it reads 0.0 V on the meter for a voltage channel, or either 0 or 4 mA for a current channel (depending on the selected range). See the “set output to:” field on the display.

- In the Main Menu, choose Service > Analog Out Cal > select Channel > **Calibrate Zero.**

```
ANALOG OUTPUT CAL:  ZERO
CONNECT METER TO OUTPUT!
SELECTED OUTPUT:    V1
SET TO:              100
← SAVE VALUE      ↑↓ INC/DEC
SET OUTPUT TO:      0.0 V
RANGE  AVG  DIAGS  ALARM
```

Analog Output Calibrate Full-Scale

The Analog Output Calibrate Full-Scale screen allows the user to calibrate the full-scale state of the selected analog output. The operator must connect a volt meter to the output and adjust the output until the meter reads the value shown in the “set output to:” field, in either V or mA, depending on the selected output channel.

- In the Main Menu, choose Service > Analog Out Cal > select Channel > **Calibrate Full Scale.**

```

ANALOG OUTPUT CAL:  SPAN
CONNECT METER TO OUTPUT!
SELECTED OUTPUT:    V1
SET TO:             3697
← SAVE VALUE      ↑↓ INC/DEC
SET OUTPUT TO:     10 V

RANGE  AVG  DIAGS  ALARM
  
```

Analog Input Calibration

The Analog Input Calibration menu is used to calibrate the 8 analog input channels at both zero and full-scale. The Analog Input Calibration menu is visible only when the I/O expansion board is installed. The analog input calibration menu is visible only when the instrument is in service mode. For more information on the service mode, see “[Service Mode](#)” earlier in the chapter.

Note This adjustment should only be performed by an instrument service technician. ▲

- In the Main Menu, choose Service > **Analog Input Cal.**

```

ANALOG INPUT CAL:
>INPUT CHANNEL 1
  INPUT CHANNEL 2
  INPUT CHANNEL 3
  INPUT CHANNEL 4
  INPUT CHANNEL 5
                                     ↓

RANGE  AVG  DIAGS  ALARM
  
```

```

ANALOG INPUT CAL:
>CALIBRATE ZERO
  CALIBRATE FULL SCALE

RANGE  AVG  DIAGS  ALARM
  
```

Analog Input Calibrate Zero

The Analog Input Calibrate Zero screen allows the user to calibrate the zero state of the selected analog input.

- In the Main Menu, choose Service > Analog Input Cal > select Channel > **Calibrate Zero.**

```

ANALOG INPUT CAL:      ZERO
DISCONNECT SELECTED INPUT!
SELECTED INPUT:      INPUT 1
CURRENTLY:           0.04 V

← CALIBRATE INPUT TO ZERO

RANGE  AVG  DIAGS  ALARM
  
```

Analog Input Calibrate Full-Scale

The Analog Input Calibrate Full-Scale screen allows the user to calibrate the full-scale state of the selected analog input.

- In the Main Menu, choose Service > Analog Input Cal > select Channel > **Calibrate Full Scale**. (Hook up a voltage source of 10 V to the analog input channel.)

```

ANALOG INPUT CAL:      SPAN
PROVIDE VOLTAGE TO INPUT!
SELECTED INPUT:      INPUT 1
CURRENTLY:           9.84 V
SET TO:             10.00 V
← CALIBRATE TO VALUE

RANGE  AVG  DIAGS  ALARM
  
```

O₂ Correction Concentration

The O₂ Correction Concentration screen is used to set the oxygen correction concentration. Acceptable values range from 0 to 20.9%. When O₂ compensation is enabled, the following equation is applied to all of the concentration values to generate corrected values (CO COR). The corrected values may be output on the analog outputs, stored in logging memory, or output as streaming data. The corrected values are not displayed on the Run screen on the front panel, only the non-corrected values:

$$C_{comp} @ O2_{corr} = C * \left(\frac{20.9 - O2_{corr}}{20.9 - O2_{meas}} \right)$$

Abbreviations: C is the measured concentration, O₂_{corr} is the oxygen concentration that C is corrected to (this value is set by the user in the SERVICE > O₂ CORRECTION CONC menu and defaults to 15%). O₂_{meas} is the measured O₂ concentration, which is clamped at 20.8% to prevent divide-by-zero errors. C_{comp} is the corrected concentration (CO COR) that may be used for analog outputs or datalogging.

- In the Main Menu, choose > Instrument Controls > **O₂ Correction Conc**.

```

O2 CORRECTION CONC:
CURRENTLY:      15.55 %
SET TO:        16.00 % ?

      ←→ MOVE CURSOR
↑↓ CHANGE VALUE  ← SAVE

RANGE  AVG  DIAGS  ALARM
  
```

Dilution Ratio

The Dilution Ratio screen allows the user to view and set the dilution ratio. Acceptable values are 1–500: 1. The default is 1:1. When this value is set, the dilution ratio is applied to all concentration measurements. This screen is only accessible if the dilution ratio option is installed and when the instrument is in service mode. For more information on the service mode, see “[Service Mode](#)” earlier in the chapter.

- In the Main Menu, choose Service > **Dilution Ratio**.

```

DILUTION RATIO:
CURRENTLY:      001.00 :1
SET TO:        002.00 :1 ?

      ←→ MOVE CURSOR
↑↓ CHANGE VALUE  ← SAVE

RANGE  AVG  DIAGS  ALARM
  
```

Setup Run Screens

The Setup Run Screens menu is used to define and edit up to five custom Run screens. When the instrument is turned on, screen 1 (or zero) is the default screen. The Setup Run Screens menu is visible only when the instrument is in the Service mode. For more information on the service mode, see “[Service Mode](#)” earlier in the chapter.

- In the Main Menu, choose Service > **Setup Run Screens**.

```

SELECT RUN SCREEN:
>RUN SCREEN 1
RUN SCREEN 2
RUN SCREEN 3
RUN SCREEN 4
RUN SCREEN 5
                                     ↓

RANGE  AVG  DIAGS  ALARM

START SCREEN →  DEFAULT
  
```

Edit Run Screen

The Edit Run Screen submenu is used to edit the contents of the custom run screen. This menu allows the user to edit the run screen title, toggle the run screen On or Off, specify the number of items to be displayed on the Run screen (1-10), and to assign a parameter to each item.

- In the Main Menu, choose Service > Setup Run Screens > **Run Screen 1-5**.

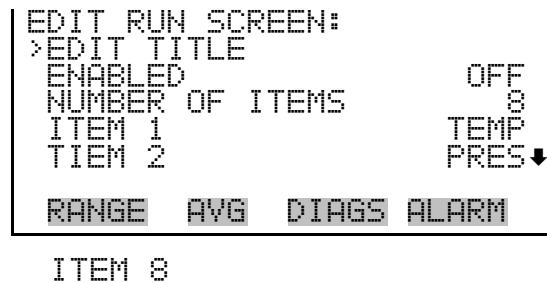

Edit Title

The Edit Title screen is used to edit the contents of the title bar on the selected Custom Run screen.

- In the Main Menu, choose Service > Setup Run Screens > select a Run Screen > **Edit Title**.



Enabled

The Enabled screen is used to toggle the selected custom Run screen On or Off. When a Run screen is On, it will be displayed when using  to scroll through the available Run screen displays. When a Run screen is OFF, it will be skipped when scrolling through the Run screen displays. For example, if Run screens 2 and 3 are set to Off, scrolling down through the available Run screen displays will display only Run screens 1, 4, and 5.

Note You cannot scroll through Run screens when a menu screen is displayed. ▲

- In the Main Menu, choose Service > Setup Run Screens > select a Run Screen > **Enabled**.

```

| ENABLE/DISABLE RUN SCREEN: |
| CURRENTLY:                OFF |
| SET TO:                   ON ? |
|                             |
|         ← TOGGLE VALUE      |
|                             |
| RANGE  AVG  DIAGS  ALARM    |
|                             |

```

Number of Items

The Number of Items menu selection is used to set the number of instrument readings to display on the custom Run screen. A maximum of 10 items can be displayed on the Run screen. A Run screen configured for 5 items or less displays the items in the large font; a Run screen with 6-10 items displays the items in the small font.

- In the Main Menu, choose Service > Setup Run Screens > select a Run Screen > **Number of Items**.

```

| SET NUMBER OF ITEMS:      |
| CURRENTLY:                5 |
| SET TO:                   4 ? |
|                             |
| ↑↓ CHANGE VALUE          ← SAVE |
|                             |
| RANGE  AVG  DIAGS  ALARM    |
|                             |

```

Select Run Screen Item

The Select Run Screen Item screen is used to assign a selected parameter to a position in the Run screen display list. Choices are Concentrations, Corrected Concentrations (if the O₂ compensation option is enabled), Other Measurements, and Analog Inputs (if the I/O expansion board is installed). Item 1 is displayed at the top of the list. If “None” is selected, the associated item will not be displayed on the Run screen.

- In the Main Menu, choose Service > Setup Run Screens > select a Run Screen > **Item 1-10**.

```
SELECT RUN SCREEN ITEM:  
CONCENTRATIONS  
CORRECTED CONCENTRATIONS  
OTHER MEASUREMENTS  
ANALOG INPUTS  
  
RANGE  AVG  DIAGS  ALARM
```

Concentrations

The Concentrations screen is used to display a list of concentration parameters that can be specified for the selected item number. The selected item is shown by “<--” after it. In dual or auto range mode, “HI” or “LO” is displayed to indicate high or low concentrations. Range Status is visible only in auto range mode. O₂ % is visible only if the O₂ compensation option is enable.

- In the Main Menu, choose Service > Setup Run Screen > select a Run Screen > select Run Screen Item > **Concentrations**.

```
CONCENTRATIONS:  
>NONE  
CO <--  
LO CO  
HI CO  
RANGE STATUS  
  
RANGE  AVG  DIAGS  ALARM  
  
O2 %
```

Corrected Concentrations

The Corrected Concentrations screen is used to display a list of corrected concentration parameters that can be specified for the selected item number. The selected item is shown by “<--” after it. In dual or auto range mode, “HI” or “LO” is displayed to indicate high or low concentrations. Range Status is visible only in auto range mode. This screen is only displayed if the O₂ compensation option is enabled.

- In the Main Menu, choose Service > Setup Run Screen > select a Run Screen > select Run Screen Item > **Corrected Concentrations**.

```
CORRECTED CONCENTRATIONS:  
>NONE  
CO COR <--  
LO CO COR  
HI CO COR  
  
RANGE  AVG  DIAGS  ALARM
```

Other Measurements

The Other Measurements screen is used to display a list of non-concentration parameters that can be specified for the selected item number. The selected item is shown by “<--” after it. In dual or auto range mode, “HI” or “LO” is displayed to indicate high or low concentrations.

- In the Main Menu, choose Service > Setup Run Screen > select a Run Screen > select Run Screen Item > **Other Measurements**.

```

OTHER MEASUREMENTS:
>NONE
S/R
LO S/R
HI S/R
INT TEMP
                                     ↓
RANGE  AVG  DIAGS  ALARM

BENCH TEMP
BENCH PRES
SAMPLE FLOW
INTENSITY
MOTOR SPEED
BIAS SUPPLY
EXT ALARMS
O2 SENS TEMP
  
```

Analog Inputs

The Analog Inputs screen is used to display a list of analog inputs (none or analog inputs 1-8) that can be specified for the selected item number. The selected item is shown by “<--” after it.

- In the Main Menu, choose Service > Setup Run Screen > select a Run Screen > select Run Screen Item > **Analog Inputs**.

```

ANALOG INPUTS:
>NONE
ANALOG IN 1
ANALOG IN 2
ANALOG IN 3
ANALOG IN 4
                                     ↓
RANGE  AVG  DIAGS  ALARM
  
```

Display Pixel Test

The Display Pixel Test is used to test the LCD display by toggling between all pixels on and all pixels off to ensure that they are functioning properly. The display pixel test is visible only when the instrument is in service mode. For more information on the service mode, see “[Service Mode](#)” earlier in the chapter.

- In the Main Menu, choose Service > **Display Pixel Test**.

```
DISPLAY PIXEL TEST:
DURING TEST PRESS 0 OR ►
TO EXIT, ◀ TO TOGGLE

◀ BEGIN TEST
0 GO BACK TO MENU

RANGE  AVG  DIAGS  ALARM
```

Restore User Defaults

The Restore User Defaults screen is used to reset the user calibration and configuration values to factory defaults. The restore user defaults screen is visible only when the instrument is in service mode. For more information on the service mode, see “[Service Mode](#)” earlier in the chapter.

- In the Main Menu, choose Service > **Restore User Defaults**.

```
RESTORE DEFAULT CAL:

◀ RESTORE

RANGE  AVG  DIAGS  ALARM
```

```
RESTORE DEFAULT CAL:

◀ RESTORE
ARE YOU SURE YOU WANT TO?
PRESS ► TO CONFIRM RESTORE

RANGE  AVG  DIAGS  ALARM
```

Password

The Password menu allows the user to configure password protection. If the instrument is “locked”, none of the settings may be changed via the front panel user interface, but they can still be changed via remote operation. When the front panel is locked, the user can still navigate the menu and view data, instrument parameters, and settings, but nothing can be changed. The password (lock) icon on the right side of the status bar indicates that the password lock is active. The items visible under the Password menu are determined by the instrument’s password status.

- In the Main Menu, choose **Password**.

```
PASSWORD MENU:
>SET PASSWORD
LOCK INSTRUMENT
CHANGE PASSWORD
REMOVE PASSWORD
UNLOCK INSTRUMENT

RANGE  AVG  DIAGS  ALARM
```

Set Password

The Set Password screen is used to set the password that is used to unlock the front panel, and is shown if the instrument is unlocked and the password is not set.

- In the Main Menu, choose Password > **Set Password**



Lock Instrument

The Lock Instrument screen is used to lock the instrument's front panel so users cannot change any settings from the front panel. The lock instrument screen is shown if the instrument is unlocked and the password is set.

- In the Main Menu, choose Password > **Lock Instrument**

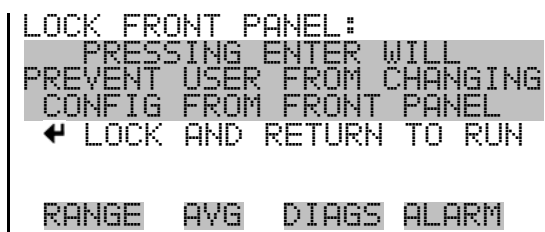

Lock/Unlock and Local/Remote Operation

If the instrument keyboard is locked via the front panel using Password > **Lock Instrument**, the instrument reports being in Remote mode. In this mode, the keypad is locked, data can be viewed but not changed using the front panel interface, and the remote “Set” commands are active.

If the instrument keyboard is unlocked via the front panel using Password > **Unlock Instrument**, the instrument reports being in Local mode, the front panel interface is unlocked, and data can be changed from the front panel.

Refer to “[C-Link Protocol Commands](#)” appendix for detailed information about “mode”, “allow mode”, and “power up mode” commands.

Change Password

The Change Password screen is used to change the password used to unlock the instrument's front panel. The change password screen is shown if the instrument is unlocked.

- In the Main Menu, choose Password > **Change Password**



Remove Password

The Remove Password screen is used to erase the current password and disable password protection. The remove password screen is shown if the instrument is unlocked and the password is set.

- In the Main Menu, choose Password > **Remove Password**



Unlock Instrument

The Unlock Instrument screen is used to enter the password to unlock the front panel. The unlock instrument screen is shown if the instrument is locked.

- In the Main Menu, choose Password > **Unlock Instrument**



Chapter 4

Calibration

This chapter describes the procedures for performing a standard zero/span calibration and a multipoint calibration of the Model 48*i*. The information described here is more than adequate to perform the calibration. However, if greater detail is needed, please refer to the *Quality Assurance Handbook for Air Pollution Measurement Systems*¹.

The following sections discuss the required apparatus and procedure for calibrating the instrument.

Equipment Required

The following equipment is required to calibrate the instrument:

CO Concentration Standard

A cylinder of CO in air containing an appropriate concentration of CO suitable for the selected operating range of the analyzer under calibration is necessary. The assay of the cylinder must be traceable either to a National Institute of Standards and Technology (NIST) CO in Air Standard Reference Material (SRM) or an NIST/EPA approved gas manufacturer's Certified Reference Material (CRM).

A recommended protocol for certifying CO gas cylinders against a CO, SRM or CRM is given in the *Quality Assurance Handbook*¹. The CO gas cylinder should be recertified on a regular basis determined by the local quality control program.

Zero Air Generator

Calibration requires zero air that is free of contaminants which will cause a detectable response on the CO analyzer. The zero air should contain <0.01 ppm CO. Since the Model 48*i* is virtually interference free, it is only necessary to ensure that CO has been removed.

It should be noted that zero air as supplied in cylinders from commercial suppliers typically contains CO concentrations in the 0.1-0.3 ppm range. So cylinder zero air should be scrubbed of the residual CO prior to its use in the Model 48*i* as a dilution gas or a zero standard. Room air which has been scrubbed of CO can also be used as the zero air source.

It is not necessary to remove SO₂, NO, NO₂, CO₂, water vapor, or hydrocarbons, since the Model 48*i* does not respond to these molecules. If

water vapor is not removed, it might be necessary to correct the flow measurement data when calculating the dilution ratio of the span CO reference.

A platinum on alumina catalyst, operated at 250 °C, has been found to be a convenient oxidizer to convert CO to CO₂.

If a zero air source is required, the following interferant removal methods are recommended:

- Compression
- Drying
- Oxidation
- Scrubbing

Compression The zero air source should be at an elevated pressure to allow accurate and reproducible flow control and to aid in subsequent operations such as drying, oxidation, and scrubbing. An air compressor that gives an output of 10 psig is usually sufficient for most applications.

Drying Several drying methods are available. Passing the compressed air through a bed of silica gel, using a heatless air dryer, or removing water vapor with a permeation dryer are three possible approaches.

Scrubbing The last step in the generation of the zero air is the removal of the remaining contaminants by either further reaction or absorption. Fixed bed reactors are usually employed.

Flow Meter(s) and Controller(s) In order to obtain an accurate dilution ratio in the dilution method used for calibration, the flow rates must be regulated to 1%, and be measured to an accuracy of at least 2%. The meter and controller can be two separate devices, or combined in one device. The user's manual for the meter should be consulted for calibration information.

Additional information on the calibration of flow devices can be found in the *Quality Assurance Handbook*¹. It should be noted that all flows should be corrected to 25 °C and 760 mmHg, and that care should be exercised in correcting for water vapor content.

Pressure Regulator for CO Standard Cylinder The regulator used must have a nonreactive diaphragm and internal parts, as well as a suitable delivery pressure.

Mixing Chamber A chamber constructed of glass, Teflon, or other nonreactive material, and designed to provide thorough mixing of CO and diluent air for the dilution method is required.

Output Manifold The output manifold should be constructed of glass, Teflon, or other nonreactive material, and should be of sufficient diameter to ensure an insignificant pressure drop at the analyzer connection. The system must have a vent designed to ensure atmospheric pressure at the manifold and to prevent ambient air from entering the manifold.

Pre-Calibration Prior to calibration, be sure the instrument is operating properly. Turn on the instrument and allow it to stabilize for one hour. Perform the service checks of the “[Preventive Maintenance](#)” chapter. Select the operating range and the averaging time of the Model 48i.

Note The averaging time should be less than the zero duration and less than the span duration. ▲

Note The calibration and calibration check duration times should be long enough to account for the transition (purge) process when switching from sample to zero and from zero to span. This transition time is the time required to purge the existing air. ▲

Note Depending on the plumbing configuration and the instrument, data from approximately the first minute of a zero calibration or check should be disregarded because of residual sample air. Also, data from approximately the first minute of a span calibration or check should be disregarded because the span is mixing with the residual zero air. ▲

Calibration Use the following procedure to calibrate the instrument.

Connect the Instrument Connect the instrument and the calibration equipment as shown in [Figure 4-1](#). If an optional sample line filter is used, the calibration must be performed through this filter. Ensure that the flow rate into the output manifold is greater than the total flow required by the analyzer and any other flow demand connected to the manifold.

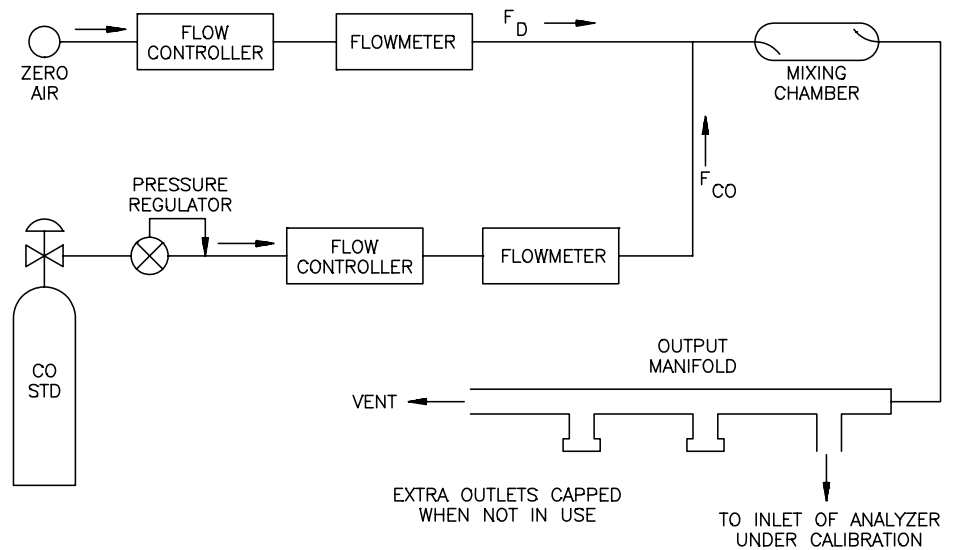



Figure 4–1. Calibration Flow Schematic

Zero Adjust

Use the following procedure to set the CO reading to zero.

1. Allow sufficient time for the Model 48*i* to warm up and stabilize.
2. Adjust the dilution system of [Figure 4–1](#) so that zero air alone is present in the manifold.

Since not all flow controllers have a positive shut off, it might be necessary to disconnect the CO input line and cap it.

3. Allow the instrument to sample zero air until a stable reading is obtained.
4. Press  and choose Calibration > **Cal Background**.
5. In the Cal Background screen, press  to set the CO reading to zero.

If a strip chart recorder is used to obtain a record of the analog output, it is recommended that the system be adjusted to obtain a zero trace at 5% of scale. This is to allow observation of zero drift and/or zero noise. Record the stable zero air response as *Z*.

Span Adjust Use the following procedure to adjust the span.

1. Adjust the zero air flow and the CO flow from the standard CO cylinder to provide a diluted CO concentration of approximately 80% of the upper range limit (URL) of the analyzer. The total air flow must exceed the total demand of the analyzer connected to the output manifold to ensure that no ambient air is pulled into the manifold vent. The exact CO concentration is calculated from:

$$[\text{CO}]_{\text{OUT}} = \frac{([\text{CO}]_{\text{STD}} \times F_{\text{CO}})}{(F_{\text{D}} + F_{\text{CO}})}$$

Where:

$[\text{CO}]_{\text{OUT}}$ = diluted CO concentration at the output manifold, ppm

$[\text{CO}]_{\text{STD}}$ = concentration of the undiluted CO standard, ppm

F_{CO} = flow rate of CO standard corrected to 25 °C and 760 mmHg, L/min

F_{D} = flow rate of dilution air corrected to 25 °C and 760 mmHg, L/min

2. Allow the instrument to sample this CO concentration standard until a stable response is obtained.
3. From the Main Menu, choose Calibration > **Cal Coef.**

The first line of the display shows the current CO concentration reading. The second line of the display shows the CO range and the third line is where the CO concentration is entered.

4. Enter the CO calibration gas concentration using the pushbuttons, and then press  to calibrate the CO reading to the CO calibration gas.

recorder response (percent scale) = $(([\text{CO}]_{\text{OUT}} \times 100)/\text{URL}) + Z_{\text{CO}}$

Where:

URL = nominal upper range limit of the instrument operating range

Z_{CO} = instrument response to zero air, %scale

5. Record the CO concentration and the instrument's response.

Calibration Frequency

In order to generate data of the highest confidence, it is recommended that a multipoint calibration be performed:

- every three months
- any time any major disassembly of components is performed

Periodic Zero and Span Checks

In order to achieve data of the highest confidence, it is suggested that periodic zero and air span checks be performed. These checks can be performed by:

1. Periodically challenging the instrument with zero air. The output of the zero air supply should be greater than the flow demand of the instrument. In addition, an atmospheric dump bypass should be utilized to ensure that the zero air gas flow is being delivered at atmospheric pressure.

Record the response in percent of scale as A_0 . Compute the zero drift from the following equation:

$$\text{Zero Drift \%} = A_0 - Z$$

Where:

Z is the recorder response obtained at the last calibration for zero air, % scale

2. Periodically challenging the instrument with a CO level of approximately 80% of the URL. The 80% URL level may be obtained by dilution of a higher level of CO using a system similar to that of [Figure 4-1](#), or by using a low level cylinder of CO containing CO in air at a concentration of approximately 80% of the URL. In either case the cylinder of CO should be checked against an SRM or CRM. It should also be true for a cylinder of low level CO.

The *Quality Assurance Handbook*¹ should be referred to for the cylinder checking procedure.

Compute the span error from the following equation:

$$\left[\frac{\text{Reported CO Concentration} - \text{Actual CO Concentration}}{\text{Actual CO Concentration}} \right] \bullet 100$$

3. Latest copy of the *Quality Assurance Handbook for Air Pollution Measurement Systems*¹ should be consulted to determine the level of acceptance of zero and span errors.

For detailed guidance in setting up a quality assurance program, refer to the *Code of Federal Regulations and the EPA Handbook on Quality Assurance*.

HI and LO Multi-Point Calibration

The instrument can also be calibrated using a dual three-point calibration. The calibration points are divided into a “low” range and a “high” range consisting of three points each:

- Cal point 1
- Cal point 2
- Cal point 3

The customer defines the ranges and Thermo Fisher Scientific recommends the following calibration points for each range:

- Cal point 1: 80% of range
- Cal point 2: 50% of range
- Cal point 3: 20% of range

Default Coefficients

Note If performing a multi-point calibration after a “bad” calibration or changing ranges it is recommended to start off with default values for the Cal point coefficients. ▲

To set default values, from the Main Menu select Service Mode > **Hi Multi-Point Cal** or **Lo Multi-Point Cal**. From Hi or Lo Multi-Point Cal, select **Default Coef** and press . The instrument will automatically reset the default values.

Cal Point 1, 2, and 3 Adjust

Use the following procedure to adjust cal points 1, 2, and 3.

1. Adjust the zero air flow and the CO flow from the standard CO cylinder to provide a diluted CO concentration of approximately 80% of the upper range limit (URL) of the instrument. The total air flow must exceed the total demand of the analyzer connected to the output manifold to ensure that no ambient air is pulled into the manifold vent. The exact CO concentration is calculated from:

Calibration

HI and LO Multi-Point Calibration

$$[\text{CO}]_{\text{OUT}} = \frac{([\text{CO}]_{\text{STD}} \times F_{\text{CO}})}{(F_{\text{D}} + F_{\text{CO}})}$$





Where:

$[\text{CO}]_{\text{OUT}}$ = diluted CO concentration at the output manifold, ppm







$[\text{CO}]_{\text{STD}}$ = concentration of the undiluted CO standard, ppm

F_{CO} = flow rate of CO standard corrected to 25 °C and 760 mmHg, L/min

F_{D} = flow rate of dilution air corrected to 25 °C and 760 mmHg, L/min





2. Allow the Model 48i to sample this CO concentration standard until a stable response is obtained.
3. From the Main Menu select Service Mode > Lo Multi-Point Cal > **Cal Point 1**.
4. Use   to move the cursor and   to increment or decrement the digit values until they match the concentration being introduced to the instrument. Press .

The instrument will perform a series of calculations and save the new parameters.

5. Press  to back up a step in the Service Mode menu.
6. Repeat Step 1 for a 50% concentration of the upper range.
7. Select Cal Point 2.
8. Use   to move the cursor and   to increment or decrement the digit values until they match the concentration being introduced to the instrument. Press .

The instrument will perform a series of calculations and save the new parameters.

9. Press  to back up a step in the Service Mode menu.
10. Repeat Step 1 for a 20% concentration of the upper range.
11. Select Cal Point 3.

12. Use   to move the cursor and   to increment or decrement the digit values until they match the concentration being introduced to the instrument. Press .

The instrument will perform a series of calculations and save the new parameters.

13. Press  to back up a step in the Service Mode menu.

14. Select Coefficients and press .

The instrument will automatically calculate the new coefficients and save the new parameters.

15. Repeat Steps 1 through 12 for Hi Multi-Point Cal.

References

1. Section 12 of EPA-454/R-98-004, *Quality Assurance Handbook for Air Pollution Measurement Systems*, Volume II, Part 1, August 1998, available at www.epa.gov/ttn/amtic/qabook.html, and 40 CFR 50, Appendix C “Measurement Principle and Calibration Procedure for the Measurement of Carbon Monoxide in the Atmosphere (Non-Dispersive Infrared Photometry)”.

Section 12 also provides information on “Calibration of Primary and Secondary Standards for Flow Measurements”.

Specific information on certification of concentration standards is given in EPA-600/R93/224, *EPA Traceability Protocol for Assay and Certification of Gaseous Calibration Standards*, 1993 Available from www.NTIS.gov (PB94130424).

Chapter 5

Preventive Maintenance

This chapter describes the periodic maintenance procedures that should be performed on the instrument to ensure proper operation.

Since usage and environmental conditions vary greatly, you should inspect the components frequently until an appropriate maintenance schedule is determined. This includes the sample pump, solenoid valves, and IR source, which have a limited life.

Other operations such as cleaning the optics and checking the calibration of the pressure and temperature transducers should be performed on a regular basis.

This chapter includes the following maintenance information and replacement procedures:

- “Safety Precautions” on page 5-1
- “Replacement Parts” on page 5-2
- “Cleaning the Outside Case” on page 5-2
- “Cleaning the Optics” on page 5-2
- “IR Source Replacement” on page 5-3
- “Fan Filter Inspection and Cleaning” on page 5-3
- “Leak Test and Pump Check Out” on page 5-4
- “Pump Rebuilding” on page 5-5

Safety Precautions



Read the safety precautions before beginning any procedures in this chapter.

WARNING If the equipment is operated in a manner not specified by the manufacturer, the protection provided by the equipment may be impaired. ▲



Equipment Damage Some internal components can be damaged by small amounts of static electricity. A properly grounded antistatic wrist strap must be worn while handling any internal component. For more information about appropriate safety precautions, see the “[Servicing](#)” chapter. ▲

Replacement Parts

See the “[Servicing](#)” chapter for a list of replacement parts and the associated replacement procedures.



WARNING If the equipment is operated in a manner not specified by the manufacturer, the protection provided by the equipment may be impaired. ▲

Cleaning the Outside Case

Clean the outside case using a damp cloth being careful not to damage the labels on the case.



Equipment Damage Do not use solvents or other cleaning products to clean the outside case. ▲

Cleaning the Optics

Best results are obtained when the optics are cleaned prior to calibration. The cleanliness of the mirrors should be checked any time the AGC intensity is below 200,000 Hz, since one cause of low output is light attenuation due to dirt on the mirrors.



Equipment Damage Some internal components can be damaged by small amounts of static electricity. A properly grounded antistatic wrist strap must be worn while handling any internal component. For more information about appropriate safety precautions, see the “[Servicing](#)” chapter. ▲

Use the following procedure to clean the mirrors.

1. Turn off power and disconnect power line.
2. Remove the field mirror by removing the four Allen head screws holding it to the main bench (use a 9/64-inch Allen wrench).

3. Carefully clean each mirror using a cotton swab and methanol. Rinse with distilled or deionized water. Dry by blowing clean dry air over the mirror.
4. Reassemble following the above procedure in reverse. It is not necessary to realign any mirror following cleaning.
5. Calibrate the instrument. See the “[Calibration](#)” chapter in this manual.

IR Source Replacement

The IR source control system has been designed to operate the wire wound resistor IR source conservatively in order to increase its life. Nevertheless, the IR source does have a finite life. Since the IR source is relatively inexpensive and easily replaced, it is recommended that the IR source be replaced after one year of continuous use. This will prevent loss of data due to IR source failure. If an IR source is to be replaced on an as needed basis, it should be replaced when:

- There is no light output
- After cleaning the optics, the IR light intensities remain below 100,000 Hz

It is not necessary to recalibrate the Model 48*i* after replacing the IR source since it is a ratio instrument, and replacing the IR source does not affect the calibration.

Fan Filter Inspection and Cleaning

Use the following procedure to inspect and clean the fan filter ([Figure 5–1](#)).

1. Remove the fan guard from the fan and remove the filter.
2. Flush the filter with warm water and let dry (a clean, oil-free purge will help the drying process) or blow the filter clean with compressed air.
3. Re-install the filter and fan guard.

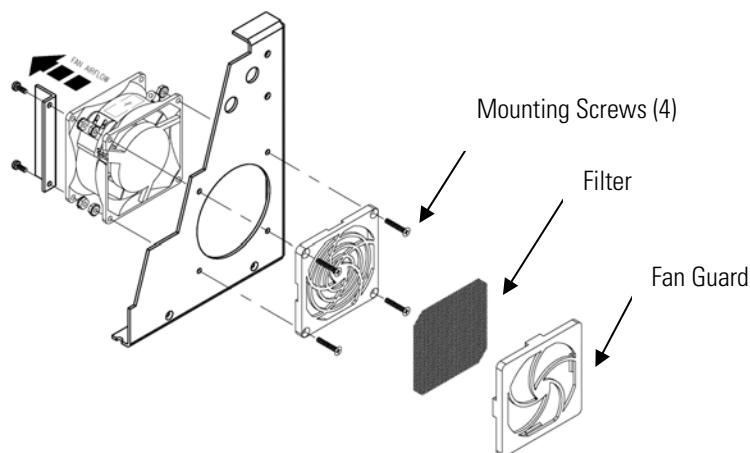







Figure 5-1. Inspecting and Cleaning the Fan

Leak Test and Pump Check Out

There are two major types of leaks: external leaks and leaks across the optional zero/span solenoid valve seals.

External Leaks

Use the following procedure to test for external leaks.

1. Disconnect the sample input line and plug the SAMPLE fitting.
2. Press  to display the Main Menu.
3. Press  to move the cursor to Diagnostics and press  to display the Diagnostics menu.
4. Press  to move the cursor to Flow and press  to display the Sample Flow screen. The flow reading should indicate zero flow and the pressure reading should be less than 250 mmHg. If not, check to see that all fittings are tight and that none of the input lines are cracked or broken. For detailed information about this screen, refer to the “[Operation](#)” chapter.

If the pump diaphragm is in good condition and the capillary not blocked, it should take less than one minute from the time the inlet is plugged to the time the reading below 250 mmHg is obtained.

Leaks Across the Optional Zero/Span and Sample Solenoid Valves

In order to check for leaks across the optional valves, plug the SPAN inlet line, press  until span appears in the status line and follow the “External Leaks” procedure.

If the pressure drops below 250 mmHg the valve associated with the span line is functioning normally. Repeat for the valve associated with the zero line by plugging the zero inlet, press  until zero appears in the status line and follow the “External Leaks” procedure.

If the pressure drops below 250 mmHg, the valve associated with the zero line is functioning normally.

Pump Rebuilding

For new technology pump, use the following procedure to rebuild the pump (Figure 5–2). The new technology pump will have the repair kit part number on its label. If no repair kit part number is listed, refer to the procedure for the older model pump following this procedure. To replace the pump, see “Pump Replacement” on page 7-20.

Equipment Required:

Flatblade screwdriver

Pump rebuild kit (flapper valve and diaphragm)



Equipment Damage Some internal components can be damaged by small amounts of static electricity. A properly grounded antistatic wrist strap must be worn while handling any internal component. ▲

Disassembly

1. Turn instrument OFF, unplug the power cord, and remove the cover. Make a sketch of the position of any tubes and fittings for ease of re-assembly later.
2. Mark the position of the pump top plate, bottom plate and compressor housing relative to each other by drawing a line on the edges with a pencil or marker to ensure proper re-assembly.
3. The aluminum compressor housing cover must be removed to gain access to the inside compressor housing. Remove the four screws and then remove the cover. Re-use any gasketing. Remove any debris that may have accumulated in the bottom of the compressor housing.

4. Remove the four top plate screws and remove the top plate. Note the positioning of the flapper valve relative to the valve ports on the top plate and bottom plate. Lift off the flapper valve.
5. Remove the bottom plate.
6. Check that all parts are clean from dirt and clean as necessary. **DO NOT** scratch the parts.
7. **Removal of the old diaphragm:** Rotate the fan so that the diaphragm is positioned at the top dead center. This will help unseat the edge of the diaphragm. If required, push up from underneath the diaphragm or use a non-metallic tool to pry up the diaphragm from the housing groove. Unscrew the old diaphragm by turning it counterclockwise using both hands. **DO NOT** use tools!

Note Take care not to lose the shim rings positioned between the diaphragm support cup and connecting rod, as the same shim rings must be used during re-assembly. ▲

While unscrewing the diaphragm with one hand, use your other hand to secure the support cup and shim ring(s) onto the diaphragm stud. Lift the diaphragm, support cup and shim ring(s) from the pump.

The compressor housing cover must be removed to gain access to and secure the support cup and shim ring(s) onto the stud. Note that the quantity and thickness of the shim ring(s) will vary from pump to pump. Parts removed must be replaced exactly as found. If repairing multiple pumps, take care not to mix the parts.

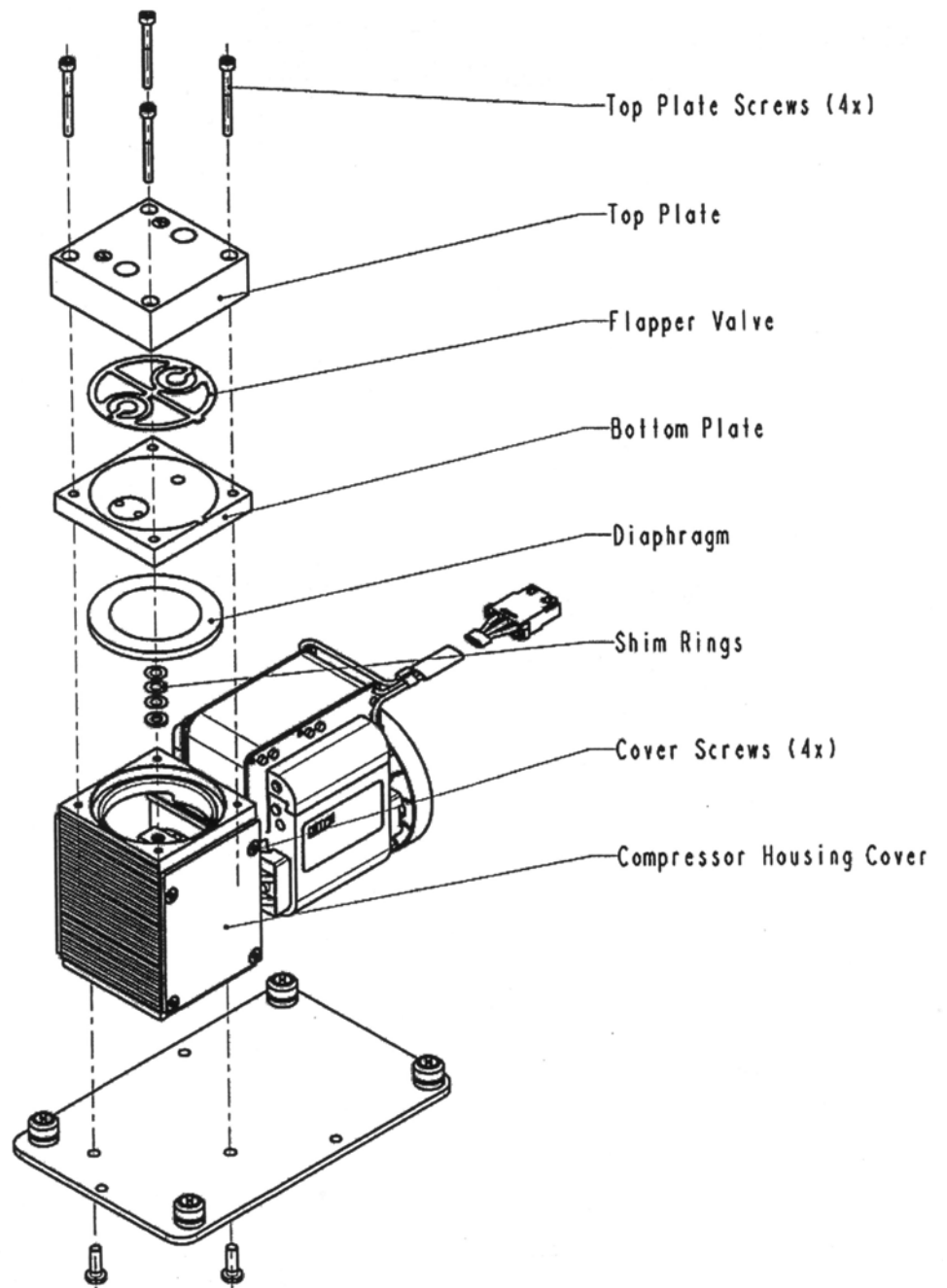

Figure 5-2. Rebuilding the Pump (New Technology)

Assembly with New Diaphragm and Valve

1. Place the parts removed in the previous step onto the threaded stud of the new diaphragm. Carefully screw the new diaphragm into the connecting rod. Secure the support cup and small parts onto the diaphragm stud using a technique similar to that used during removal. It is helpful to hold the connecting rod at a slight angle until the threads are started. Spin the diaphragm on until it is snug, then lift and grip the edges of the diaphragm at 7 and 2 o'clock and tighten firmly using both hands. **DO NOT** use tools!

Tip: If the pump is loose and not mounted, position and hold the pump with the motor shaft vertical when starting the threaded diaphragm stud into the connecting rod. This helps to prevent the small parts from falling off the stud.

2. Turn the fan until the diaphragm is flat across (mid-point of the stroke). With the diaphragm centered over the compressor housing, firmly seat the diaphragm edge into the compressor housing groove.
3. Place the clean bottom plate onto the compressor housing using the reference mark made earlier to ensure the correct orientation. Then place the new flapper on top of the intermediate plate.
4. Place the clean top plate on top of the bottom plate using the reference mark made earlier to ensure the correct orientation. Tighten the four top plate screws snugly in a diagonal pattern and then tighten to a maximum torque of 6-7 inch-lbs. Turn the fan by hand to confirm that the pump turns freely.
5. Replace the compressor housing cover and gasket. Install the four cover screws. No not over-tighten.

For older models, use the following procedure to rebuild the pump (Figure 5-3). To replace the pump, see “Pump Replacement” on page 7-20.

1. Turn instrument OFF, unplug the power cord, and remove the cover.
2. Loosen the fittings and remove both lines going to the pump.
3. Remove the four screws from the top plate, remove top plate, flapper valve, and the bottom plate.
4. Remove the screw securing the diaphragm to piston and remove diaphragm.
5. Assemble the pump by following the previous steps in reverse, make sure the Teflon® (white) side of the diaphragm is facing up and that the flapper valves cover the holes of the top and bottom plate.
6. Perform the “Leak Test and Pump Check Out” on page 5-4.

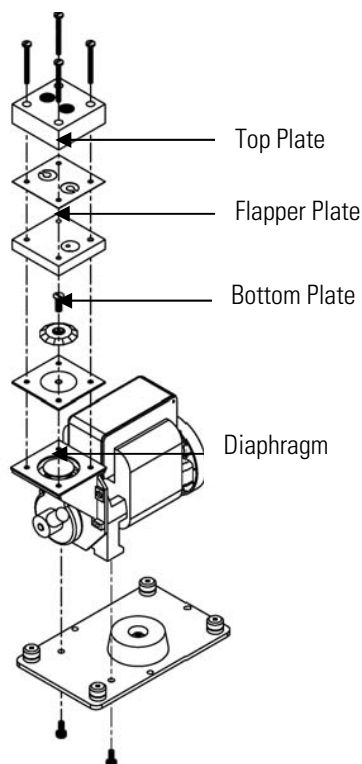

Figure 5-3. Rebuilding the Pump

Chapter 6

Troubleshooting

This instrument has been designed to achieve a high level of reliability. In the event of problems or failure, the troubleshooting guidelines, board-level connection diagrams, connector pin descriptions, and testing procedures presented in this chapter should be helpful in isolating and identifying problems.

For additional fault location information refer to the “[Preventive Maintenance](#)” chapter in this manual.

The service mode in the “[Operation](#)” chapter includes parameters and functions that are useful when making adjustments or diagnosing problems.

The Technical Support Department at Thermo Fisher Scientific can also be consulted in the event of problems. See “[Service Locations](#)” on page 6-20 for contact information. In any correspondence with the factory, please note both the serial number and program number of the instrument.

This chapter provides the following troubleshooting and service support information:

- “[Safety Precautions](#)” on page 6-1
- “[Troubleshooting Guides](#)” on page 6-1
- “[Board-Level Connection Diagrams](#)” on page 6-5
- “[Connector Pin Descriptions](#)” on page 6-7
- “[Service Locations](#)” on page 6-20

Safety Precautions

Read the safety precautions in the Preface and “[Servicing](#)” chapter before performing any actions listed in this chapter.

Troubleshooting Guides

The troubleshooting guides presented in this chapter are designed to help isolate and identify instrument problems.

[Table 6–1](#) provides general troubleshooting information and indicates the checks that you should perform if you experience an instrument problem.

Table 6–2 lists all the alarm messages you may see on the graphics display and provides recommendations about how to resolve the alarm condition.

Table 6–1. Troubleshooting - General Guide

Malfunction	Possible Cause	Action
Does not start (the light on display does not come on and the pump motor is not running)	No power or wrong power configuration	Check the line to confirm that power is available and that it matches the voltage and frequency configuration of the instrument.
	Main fuse is blown or missing	Unplug the power cord, open the fuse drawer on the back panel, and check the fuses visually or with a multimeter.
	Bad switch or wiring connection	Unplug the power cord, disconnect the switch and check operation with a multimeter.
Pressure transducer does not hold calibration or is noisy	Pressure transducer defective	Replace pressure transducer.
Run output noisy	Recorder noise	Replace or repair recorder.
	Sample CO concentration varying	Run instrument on a span CO source - if quiet, there is no malfunction.
	Foreign material in optical bench	Clean optical bench.
Analyzer does not calibrate properly	System leak	Find and repair leak.
	Pressure or temperature transducer out of calibration	Recalibrate pressure and temperature transducer.
	Dirty system	Clean cells and flow components.
	Leaky correlation wheel	Replace with a known good wheel.
Analog test ramp	Faulty recorder	Replace recorder.
	D/A calibration off	Re-calibrate the D/A with a DMV known to be in calibration.

Table 6–2. Troubleshooting - Alarm Messages

Alarm Message	Possible Cause	Action
Alarm - Internal Temp	Check fan operation	Replace fan if not operating properly.
	Check fan filter	Clean or replace foam filter, refer to "Preventive Maintenance" chapter in this manual.
Alarm – Chamber Temp	Chamber temperature below set point of 50 °C	Check 10K ohm thermistor, replace if bad. Check temperature control board to insure the LEDs are coming on. If not, temperature control board could be defective.
Alarm - Pressure	High pressure indication	Check the pump for a tear in the diaphragm, replace with pump repair kit if necessary. Refer to "Preventive Maintenance" chapter in this manual. Check that capillaries are properly installed and O-rings are in good shape. Replace if necessary. Check flow system for leaks.
Alarm - Flow	Flow low	Check sample capillary (0.015 inch ID) for blockage. Replace as necessary. If using sample particulate filter make sure it is not blocked. Disconnect sample particulate filter from the sample bulkhead, if flow increases, replace the filter.
Alarm - Bias voltage	Defective measurement interface board	Replace measurement interface board.
	Defective pre-amp board	Replace pre-amp board.
Alarm - AGC intensity	Pre-amp Gain not set properly	Check Gain adjustment.
	Defective measurement interface board	Replace measurement interface board.

Alarm Message	Possible Cause	Action
Alarm - Motor Speed	Defective measurement interface board	Replace measurement interface board.
	Defective chopper motor or cable	Check chopper motor cable. Replace chopper motor.
Alarm - CO Conc.	Concentration has exceeded range limit	Check to insure range corresponds with expected value. If not select proper range.
	Concentration low	Check user-defined low set point, set to zero.
Alarm - Zero Check Alarm - Span Check	Instrument out of calibration	Recalibrate instrument.
Alarm - Zero Autocal Alarm - Span Autocal		Check gas supply. Perform manual calibration.
Alarm - Motherboard Status Alarm - Interface Status Alarm - I/O Exp Status	Internal cables not connected properly Board is defective	Check that all internal cables are connected properly. Recycle AC power to instrument. If still alarming, change board.

Board-Level Connection Diagrams

Figure 6–1 and Figure 6–2 are board-level connection diagrams for the common electronics and measurement system. These illustrations can be used along with the connector pin descriptions in Table 6–3 through Table 6–8 to troubleshoot board-level faults.

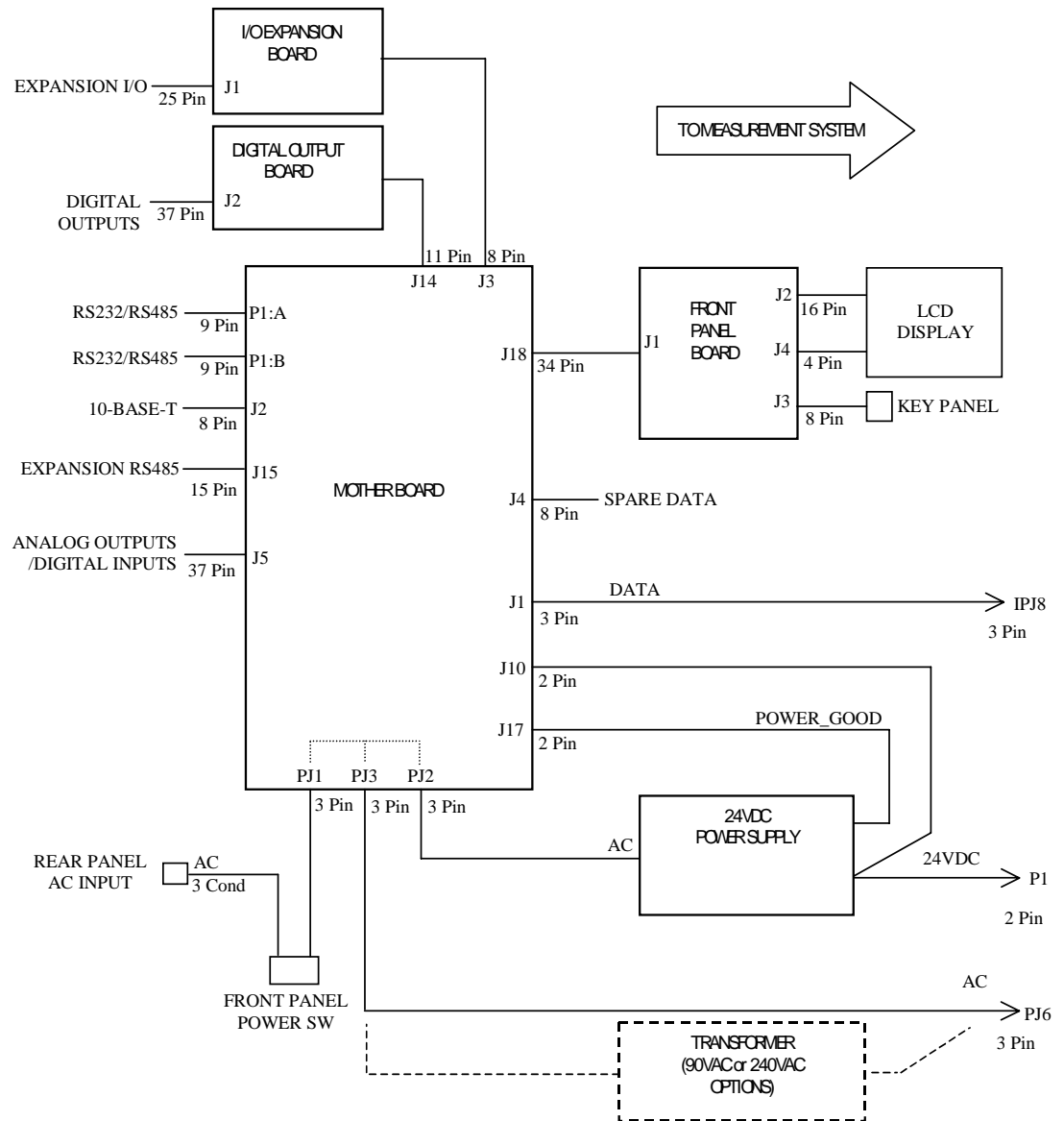

Figure 6–1. Board-Level Connection Diagram - Common Electronics

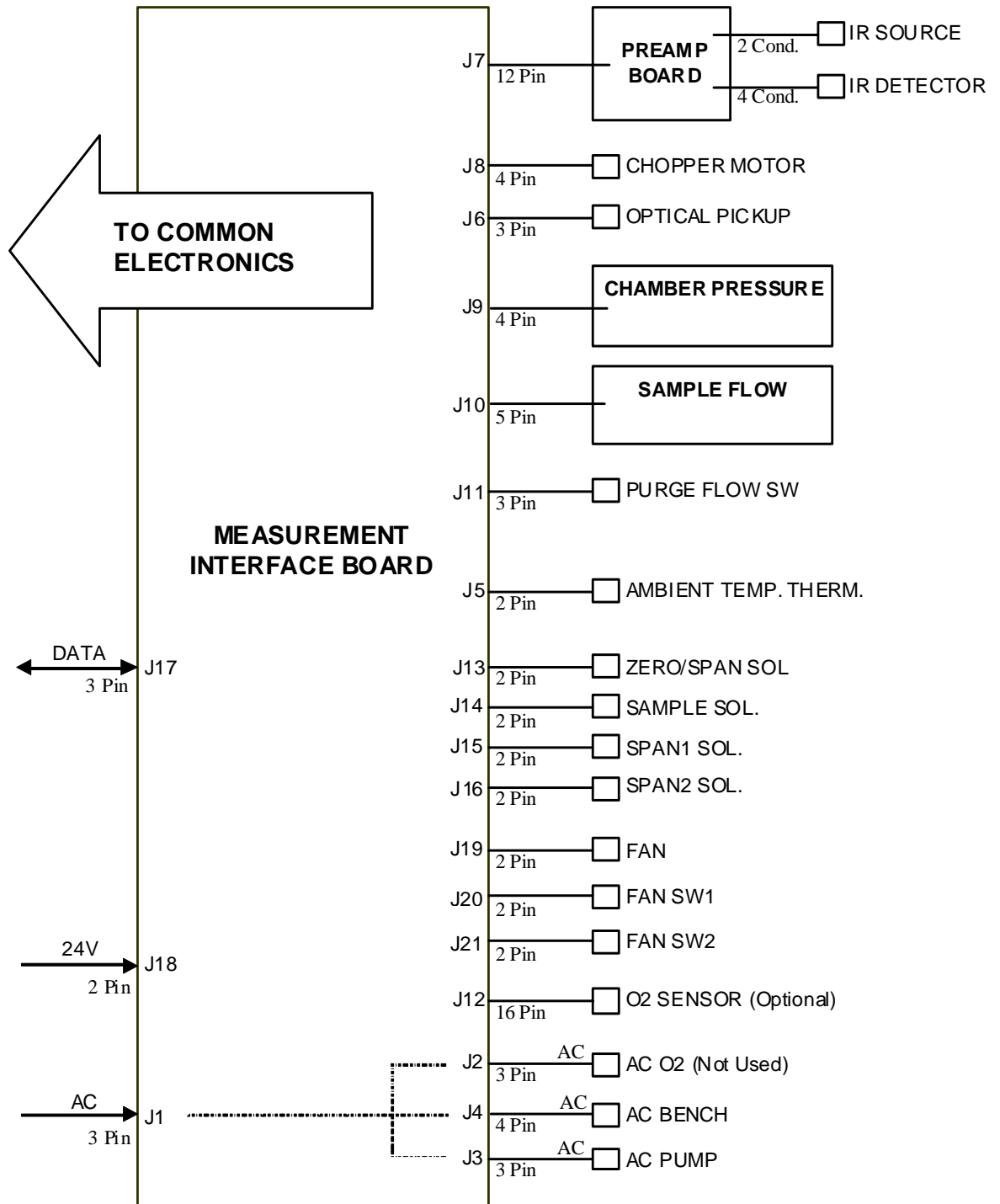

Figure 6-2. Board-Level Connection Diagram - Measurement System

Connector Pin Descriptions

The connector pin descriptions in [Table 6–3](#) through [Table 6–8](#) can be used along with the board-level connection diagrams to troubleshoot board-level faults.

[“Motherboard Connector Pin Descriptions” on page 6-7](#)

[“Measurement Interface Board Connector Pin Descriptions” on page 6-12](#)

[“Front Panel Board Connector Pin Diagram” on page 6-14](#)

[“I/O Expansion Board \(Optional\) Connector Pin Descriptions” on page 6-16](#)

[“Digital Output Board Connector Pin Descriptions” on page 6-17](#)

[“Pre-amp Board Connector Pin Descriptions” on page 6-19](#)

Table 6–3. Motherboard Connector Pin Descriptions

Connector Label	Reference Designator	Pin	Signal Description
INTF DATA	J1	1	Ground
		2	+RS485 to Interface Board
		3	-RS485 to Interface Board
10-BASE-T	J2	1	Ethernet Output (+)
		2	Ethernet Output (-)
		3	Ethernet Input (+)
		4	NC
		5	NC
		6	Ethernet Input (-)
		7	NC
		8	NC
EXPANSION BD	J3	1	+5V
		2	+24V
		3	+24V
		4	Ground
		5	Ground
		6	Ground
		7	+RS485 to Expansion Board
		8	-RS485 to Expansion Board

Troubleshooting

Connector Pin Descriptions

Connector Label	Reference Designator	Pin	Signal Description
INTERFACE 24V	J4	1	+24V
		2	Ground
I/O	J5	1	Power Fail Relay N.C. Contact
		2	Digital Ground
		3	TTL Input 1
		4	TTL Input 2
		5	Digital Ground
		6	TTL Input 5
		7	TTL Input 7
		8	TTL Input 8
		9	TTL Input 10
		10	Ground
		11	TTL Input 13
		12	TTL Input 15
		13	Digital Ground
		14	Analog Voltage 1
		15	Analog Voltage 3
		16	Analog Ground
		17	Analog Voltage 5
		18	Analog Ground
		19	Analog Ground
		20	Power Fail Relay COM
		21	Power Fail Relay N.O. Contact
		22	Digital Ground
		23	TTL Input 3
		24	TTL Input 4
		25	TTL Input 6
		26	Digital Ground
		27	TTL Input 9
		28	TTL Input 11
		29	TTL Input 12
		30	TTL Input 14
		31	TTL Input 16
		32	Digital Ground

Connector Label	Reference Designator	Pin	Signal Description
		33	Analog Voltage 2
		34	Analog Voltage 4
		35	Analog Ground
		36	Analog Voltage 6
		37	Analog Ground
VOLTAGE TEST	J6	1	+5V
		2	+3.3V
			+15V
			-15V
SER EN	J7	1	Serial Enable Jumper
		2	+3.3V
24V IN	J10	1	+24V
		2	Ground
RESET PROC	J12	1	Reset-Proc
		2	Ground
DIGITAL I/O	J14	1	+5V
		2	+24V
		3	+24V
		4	Ground
		5	Ground
		6	Ground
		7	SPI Reset
		8	SPI Input
		9	SPI Output
		10	SPI Board Select
		11	SPI Clock
EXT. RS485	J15	1	-RS485 to Rear Panel
		2	-RS485 to Rear Panel
		3	+5V
		4	+5V
		5	+5V
		6	Ground
		7	Ground
		8	Ground

Troubleshooting

Connector Pin Descriptions

Connector Label	Reference Designator	Pin	Signal Description
		9	NC
		10	NC
		11	+24
		12	+24
		13	+24
		14	+24
		15	+24
24 MONITOR	J17	1	24V Power Monitor
		2	Ground
FRONT PANEL BD	J18	1	Ground
		2	Ground
		3	LCLK – LCD Signal
		4	Ground
		5	Ground
		6	LLP – LCD Signal
		7	LFLM – LCD Signal
		8	LD4 – LCD Signal
		9	LD0 – LCD Signal
		10	LD5 – LCD Signal
		11	LD1 – LCD Signal
		12	LD6 – LCD Signal
		13	LD2 – LCD Signal
		14	LD7 – LCD Signal
		15	LD3 – LCD Signal
		16	LCD Bias Voltage
		17	+5V
		18	Ground
		19	Ground
		20	LCD_ONOFF – LCD Signal
		21	Keypad Row 2 Input
		22	Keypad Row 1 Input
		23	Keypad Row 4 Input
		24	Keypad Row 3 Input

Connector Label	Reference Designator	Pin	Signal Description
		25	Keypad Col 2 Select
		26	Keypad Col 1 Select
		27	Keypad Col 4 Select
		28	Keypad Col 3 Select
		29	Ground
		30	Ground
		31	Ground
		32	Ground
		33	+24V
		34	+24V
RS232/RS485:A	P1:A	1	NC
		2	Serial Port 1 RX (-RS485 IN)
		3	Serial Port 1 TX (-RS485 OUT)
		4	NC
		5	Ground
		6	NC
		7	Serial Port 1 RTS (+RS485 OUT)
		8	Serial Port 1 CTS (+RS485 IN)
		9	NC
RS232/RS485:B	P1:B	1	NC
		2	Serial Port 2 RX (-RS485 IN)
		3	Serial Port 2 TX (-RS485 OUT)
		4	NC
		5	Ground
		6	NC
		7	Serial Port 2 RTS (+RS485 OUT)
		8	Serial Port 2 CTS (+RS485 IN)
		9	NC
AC IN	PJ1	1	AC-HOT
		2	AC-NEUT
		3	AC-Ground
AC 24VPWR	PJ2	1	AC-HOT
		2	AC-NEUT
		3	AC-Ground

Troubleshooting

Connector Pin Descriptions

Connector Label	Reference Designator	Pin	Signal Description
AC INTF BD	PJ3	1	AC-HOT
		2	AC-NEUT
		3	AC-Ground

Table 6–4. Measurement Interface Board Connector Pin Descriptions

Connector Label	Reference Designator	Pin	Signal Description
AC IN	J1	1	AC-HOT
		2	AC-NEUT
		3	AC-Ground
AC O2	J2	1	AC-HOT
		2	AC-NEUT
		3	AC-Ground
AC PUMP	J3	1	AC-HOT
		2	AC-NEUT
		3	AC-Ground
AC BENCH	J4	1	Bench Thermistor
		2	Ground
		3	AC-HOT
		4	Bench Heater AC Control
AMB TEMP	J5	1	Ambient Temperature Thermistor
		2	Ground
OPT	J6	1	Optical Pickup Input
		2	Ground
		3	Optical Pickup Source Drive
PREAMP BD	J7	1	Preamp Signal Input
		2	Ground for Shield
		3	Ground
		4	SPI – Data Out
		5	SPI - CLK
		6	SPI - CS
		7	+15V
		8	+5V

Connector Label	Reference Designator	Pin	Signal Description
		9	+18V for IR Source
		10	Ground
		11	-100V
		12	-100V Return
MOT DRV	J8	1	Motor Drive Voltage 1
		2	Motor Drive Voltage 2
		3	Motor Drive Voltage 3
		4	Motor Drive Voltage 4
PRES	J9	1	Chamber Pressure Sensor Input
		2	Ground
		3	+15V
		4	-15V
FLOW	J10	1	Sample Flow Sensor Input
		2	Ground
		3	+15V
		4	-15V
		5	Ground
FLOW SW	J11	1	NC
		2	Ground
		3	Purge Flow Input
O2 SENS	J12	1	NC
		2	NC
		3	NC
		4	NC
		5	Ground
		6	+5V
		7	NC
		8	NC
		9	Ground
		10	Analog Input O2 Sensor
		11	NC
		12	NC
		13	NC
		14	Analog Input O2 Sensor Temperature

Troubleshooting

Connector Pin Descriptions

Connector Label	Reference Designator	Pin	Signal Description
		15	NC
		16	+5V
Z/S	J13	1	+24V
		2	Zero/Span Solenoid Control
SAMPLE	J14	1	+24V
		2	Sample Solenoid Control
SPAN1	J15	1	+24V
		2	Converter Solenoid Control
SPAN2	J16	1	+24V
		2	Span 2 Solenoid Control
DATA	J17	1	Ground
		2	+RS485 from Motherboard
		3	-RS485 from Motherboard
24V IN	J18	1	+24V Input
		2	Ground
FAN	J19	1	+24V (Fused)
		2	Ground
FAN SW1	J20	1	+24V (Fused)
		2	Fan Control
FAN SW2	J21	1	+24V (Fused)
		2	Fan Control

Table 6–5. Front Panel Board Connector Pin Diagram

Connector Label	Reference Designator	Pin	Signal Description
MOTHERBOARD	J1	1	Ground
		2	Ground
		3	LCLK – LCD Signal
		4	Ground
		5	Ground
		6	LLP – LCD Signal
		7	LFLM – LCD Signal
		8	LD4 – LCD Signal

Connector Label	Reference Designator	Pin	Signal Description
		9	LD0 – LCD Signal
		10	LD5 – LCD Signal
		11	LD1 – LCD Signal
		12	LD6 – LCD Signal
		13	LD2 – LCD Signal
		14	LD7 – LCD Signal
		15	LD3 – LCD Signal
		16	LCD Bias Voltage
		17	+5V
		18	Ground
		19	Ground
		20	LCD_ONOFF – LCD Signal
		21	Keypad Row 2 Input
		22	Keypad Row 1 Input
		23	Keypad Row 4 Input
		24	Keypad Row 3 Input
		25	Keypad Col 2 Select
		26	Keypad Col 1 Select
		27	Keypad Col 4 Select
		28	Keypad Col 3 Select
		29	Ground
		30	Ground
		31	Ground
		32	Ground
		33	+24V
		34	+24V
LCD DATA	J2	1	LD0_5V – LCD Signal
		2	LD1_5V – LCD Signal
		3	LD2_5V – LCD Signal
		4	LD3_5V – LCD Signal
		5	LCD_ONOFF_5V – LCD Signal
		6	LFLM_5V – LCD Signal
		7	NC
		8	LLP_5V – LCD Signal

Troubleshooting

Connector Pin Descriptions

Connector Label	Reference Designator	Pin	Signal Description
		9	LCLK_5V – LCD Signal
		10	+5V
		11	Ground
		12	-25V
		13	LCD Bias Voltage
		14	Ground
KEYBOARD	J3	1	Keypad Row 1 Input
		2	Keypad Row 2 Input
		3	Keypad Row 3 Input
		4	Keypad Row 4 Input
		5	Keypad Col 1 Select
		6	Keypad Col 2 Select
		7	Keypad Col 3 Select
		8	Keypad Col 4 Select
LCD BACKLIGHT	J4	1	+5V Supply
		2	NC
		3	Ground

Table 6–6. I/O Expansion Board (Optional) Connector Pin Descriptions

Connector Label	Reference Designator	Pin	Signal Description
EXPANSION I/O	J1	1	Analog Voltage Input 1
		2	Analog Voltage Input 2
		3	Analog Voltage Input 3
		4	Ground
		5	Analog Voltage Input 4
		6	Analog Voltage Input 5
		7	Analog Voltage Input 6
		8	Ground
		9	Analog Voltage Input 7
		10	Analog Voltage Input 8
		11	Ground
		12	NC

Connector Label	Reference Designator	Pin	Signal Description
		13	Current Output Return
		14	Ground
		15	Current Output 1
		16	Current Output Return
		17	Current Output 2
		18	Current Output Return
		19	Current Output 3
		20	Current Output Return
		21	Current Output 4
		22	Current Output Return
		23	Current Output 5
		24	Current Output Return
		25	Current Output 6
MOTHER BD	J2	1	+5V
		2	+24V
		3	+24V
		4	Ground
		5	Ground
		6	Ground
		7	+RS485 to Motherboard
		8	-RS485 to Motherboard

Table 6–7. Digital Output Board Connector Pin Descriptions

Connector Label	Reference Designator	Pin	Signal Description
MOTHER BD	J1	1	+5V
		2	+24V
		3	+24V
		4	Ground
		5	Ground
		6	Ground
		7	SPI Reset
		8	SPI Input

Troubleshooting

Connector Pin Descriptions

Connector Label	Reference Designator	Pin	Signal Description
		9	SPI Output
		10	SPI Board Select
		11	SPI Clock
DIGITAL OUTPUTS	J2	1	Relay 1 Contact a
		2	Relay 2 Contact a
		3	Relay 3 Contact a
		4	Relay 4 Contact a
		5	Relay 5 Contact a
		6	Relay 6 Contact a
		7	Relay 7 Contact a
		8	Relay 8 Contact a
		9	Relay 9 Contact a
		10	Relay 10 Contact a
		11	NC
		12	Solenoid Drive Output 1
		13	Solenoid Drive Output 2
		14	Solenoid Drive Output 3
		15	Solenoid Drive Output 4
		16	Solenoid Drive Output 5
		17	Solenoid Drive Output 6
		18	Solenoid Drive Output 7
		19	Solenoid Drive Output 8
		20	Relay 1 Contact b
		21	Relay 2 Contact b
		22	Relay 3 Contact b
		23	Relay 4 Contact b
		24	Relay 5 Contact b
		25	Relay 6 Contact b
		26	Relay 7 Contact b
		27	Relay 8 Contact b
		28	Relay 9 Contact b
		29	Relay 10 Contact b
		30	+24V

Connector Label	Reference Designator	Pin	Signal Description
		31	+24V
		32	+24V
		33	+24V
		34	+24V
		35	+24V
		36	+24V
		37	+24V

Table 6–8. Pre-amp Board Connector Pin Descriptions

Connector Label	Signal Description
OUT	Preamp Signal Output
SH	Ground for Shield
BLK	Ground
GRN	SPI – Data Out
ORG	SPI - CLK
VIO	SPI - CS
BLU	+15V
BRN	+5V
RED	+18V for IR Source
WHT	-100V
BLK	+18V for IR Source
YEL	IR Source Return
YEL	IR Detector Return
RED	IR Detector Cooler +
BLK	IR Detector Cooler -
WHT	IR Detector
WHT	IR Detector

Service Locations

For additional assistance, service is available from exclusive distributors worldwide. Contact one of the phone numbers below for product support and technical information or visit us on the web at www.thermo.com/aqi.

1-866-282-0430 Toll Free

1-508-520-0430 International

Chapter 7

Servicing

This chapter explains how to replace the Model 48*i* subassemblies. It assumes that a subassembly has been identified as defective and needs to be replaced (or is an “expendable” item, not covered under warranty. Expendable items are indicated with an asterisk (*) in the “[Model 48i Replacement Parts](#)” table.

For fault location information refer to the “[Preventive Maintenance](#)” chapter and the “[Troubleshooting](#)” chapter in this manual.

The service mode described in the “[Operation](#)” chapter also includes parameters and functions that are useful when making adjustments or diagnosing problems.

For additional service assistance, see “[Service Locations](#)” on page 7-41.

This chapter includes the following parts information and component replacement procedures:

- “[Safety Precautions](#)” on page 7-3
- “[Firmware Updates](#)” on page 7-4
- “[Accessing the Service Mode](#)” on page 7-4
- “[Replacement Parts List](#)” on page 5-2
- “[Cable List](#)” on page 7-6
- “[External Device Connection Components](#)” on page 7-6
- “[Removing the Measurement Case Assembly and Lowering the Partition Panel](#)” on page 7-8
- “[Fuse Replacement](#)” on page 7-8
- “[Fan/Filter Replacement](#)” on page 7-10
- “[IR Source Replacement](#)” on page 7-11
- “[Filter Wheel Replacement](#)” on page 7-12
- “[Chopper Motor Replacement](#)” on page 7-14
- “[Optical Bench Replacement](#)” on page 7-15
- “[Optical Switch Replacement](#)” on page 7-16

- “Bench Heater Assembly Replacement” on page 7-17
- “Detector/Preamplifier Assembly Replacement” on page 7-18
- “Preamp Board Calibration” on page 7-20
- “Pump Replacement” on page 7-20
- “Pressure Transducer Replacement” on page 7-21
- “Pressure Transducer Calibration” on page 7-22
- “Flow Transducer Replacement” on page 7-25
- “Flow Transducer Calibration” on page 7-25
- “Capillary Cleaning or Replacement” on page 7-26
- “Optional Zero/Span and Sample Solenoid Valve Replacement” on page 7-27
- “Analog Output Testing” on page 7-28
- “Analog Output Calibration” on page 7-30
- “Analog Input Calibration” on page 7-31
- “Ambient Temperature Calibration” on page 7-33
- “I/O Expansion Board (Optional) Replacement” on page 7-34
- “Internal O2 Sensor (Optional) Replacement” on page 7-36
- “Digital Output Board Replacement” on page 7-36
- “Motherboard Replacement” on page 7-37
- “Measurement Interface Board Replacement” on page 7-38
- “Front Panel Board Replacement” on page 7-39
- “LCD Module Replacement” on page 7-40
- “Service Locations” on page 7-41

Safety Precautions

Read the safety precautions before beginning any procedures in this chapter.



WARNING The service procedures in this manual are restricted to qualified service representatives. ▲

If the equipment is operated in a manner not specified by the manufacturer, the protection provided by the equipment may be impaired. ▲



CAUTION If the LCD panel breaks, do not let the liquid crystal contact your skin or clothes. If the liquid crystal contacts your skin or clothes, wash immediately using soap and water. ▲



Equipment Damage Some internal components can be damaged by small amounts of static electricity. A properly grounded antistatic wrist strap must be worn while handling any internal component (Figure 7-1). If an antistatic wrist strap is not available, be sure to touch the instrument chassis before touching any internal components. When the instrument is unplugged, the chassis is not at earth ground. ▲

Do not remove the LCD panel or frame from the LCD module. ▲

The LCD polarizing plate is very fragile, handle it carefully. ▲

Do not wipe the LCD polarizing plate with a dry cloth, as it may easily scratch the plate. ▲

Do not use alcohol, acetone, MEK or other Ketone based or aromatic solvents to clean the LCD module, but rather use a soft cloth moistened with a naphtha cleaning solvent. ▲

Do not place the LCD module near organic solvents or corrosive gases. ▲

Do not shake or jolt the LCD module. ▲

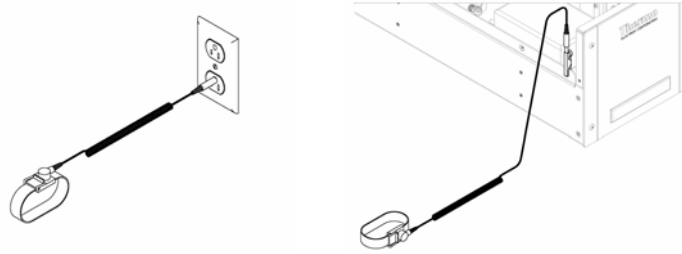





Figure 7-1. Properly Grounded Antistatic Wrist Strap

Firmware Updates

The firmware can be updated by the user in the field via the serial port or over the Ethernet. This includes both the main processor firmware and the firmware in all low-level processors. Refer to the *iPort* manual for the firmware update procedure.

Accessing the Service Mode

If the Service menu is not displayed on the Main Menu, use the following procedure to display it.

1. From the Main Menu, choose Instrument Controls > **Service Mode**.
The Service Mode screen appears.
2. Press  to toggle the Service Mode to ON.
3. Press  >  to return to the Main Menu.
4. Return to the procedure.

Replacement Parts List

Table 7-1 lists the replacement parts for the Model 48*i* major subassemblies. Refer to Table 7-2 to identify the component location.

Table 7-1. Model 48*i* Replacement Parts

Part Number	Description
100480-00	Front Panel Pushbutton Board
101491-10	Processor Board
100533-00	Motherboard
100539-00	Digital Output Board
100542-00	I/O Expansion Board (optional)
102340-00	Front Panel Connector Board

Part Number	Description
102496-00	Front Panel Display
101399-00	Transformer, 220-240VAC (optional)
101863-00	Transformer, 100VAC (optional)
100868-00	Measurement Interface Board
101780-00	Detector Assembly
101686-00	Heater Board Assembly
101023-00	Pressure Transducer
102055-00	Flow Transducer (sample)
101390-00	Solenoid Valve
101426-00	Pump 110 VAC w/Plate and Fittings
108002-00	Pump Repair Kit (new technology pump)*
8606	Pump Repair Kit*
101055-00	AC Receptacle Assembly
101681-00	Power Supply Assembly, 24VDC, w/Base Plate and Screws
100907-00	Fan, 24VDC
4510	Fuse, 250VAC, 3.0 Amp, SlowBlow (for 100VAC and 110VAC models)*
14007	Fuse, 250VAC, 1.60 Amp, SlowBlow (for 220-240VAC models)*
7336	Capillary, 0.018-inch ID
8630	Filter Guard Assembly (w/foam)*
7361	I/R Source
101424-00	Optical Switch
7412	Field Mirror
7413	Entrance Mirror
7414	Exit Mirror
7358	Filter, Wheel Assembly
101427-00	Chopper Motor
104678-00	O ₂ Sensor
4119	Capillary 0.008-inch ID (O ₂ sensor option)

*Expendable item, not covered by warranty

Cable List

Table 7–2 describes the Model 48*i* cables. See the “[Troubleshooting](#)” chapter for associated connection diagrams and board connector pin descriptions.

Table 7–2. Model 48*i* Cables

Part Number	Description
101036-00	DC Power Supply, 24V Output
101037-00	115VAC Supply to Measurement Interface Board
101048-00	RS-485/Data
101038-00	Power Switch to Motherboard
101364-00	DC Power Supply Status Monitor
101054-00	Motherboard to Front Panel Board
101035-00	DC Power Supply AC Input
101033-00	AC from Receptacle
101377-00	AC to Power Switch
101267-00	Fan Power Cable
104686-00	Cable, O ₂ Sensor (optional)

External Device Connection Components

Table 7–3 lists the standard and optional cables and components used for connecting external devices such as PCs and data loggers to an *iSeries* instrument.

Table 7–3. External Device Connection Components

Part Number	Description
102562-00	Terminal Block and Cable Kit (DB25) (optional)
102556-00	Terminal Block and Cable Kit (DB37) (optional)
102645-00	Cable, DB37M to Open End Cable, Six Feet (optional)
102646-00	Cable, DB37F to Open End, Six Feet (optional)
102659-00	Cable, DB25M to Open End, Six Feet (optional)
6279	Cable, RS-232 (optional)
102888-00	Terminal Board PCB Assembly, DB37F (standard)
102891-00	Terminal Board PCB Assembly, DB37M (standard)
103084-00	Terminal Board PCB Assembly, DB25M (included with optional I/O Expansion Board)

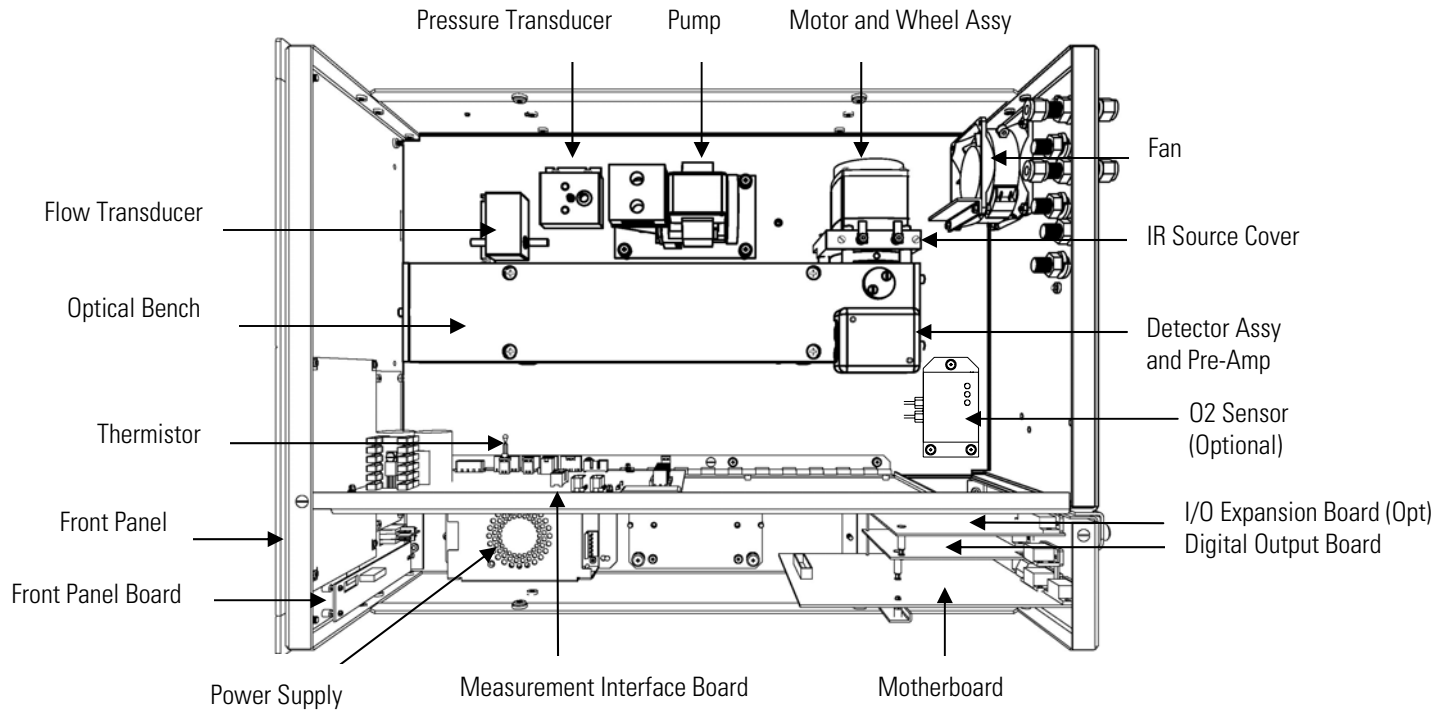

Figure 7-2. Component Layout

Servicing

Removing the Measurement Case Assembly and Lowering the Partition Panel

Removing the Measurement Case Assembly and Lowering the Partition Panel

The measurement case assembly can be removed and the partition panel can be lowered to improve access to connectors and components. Refer to the following steps when a procedure requires lowering the partition panel (see [Figure 7-3](#)).

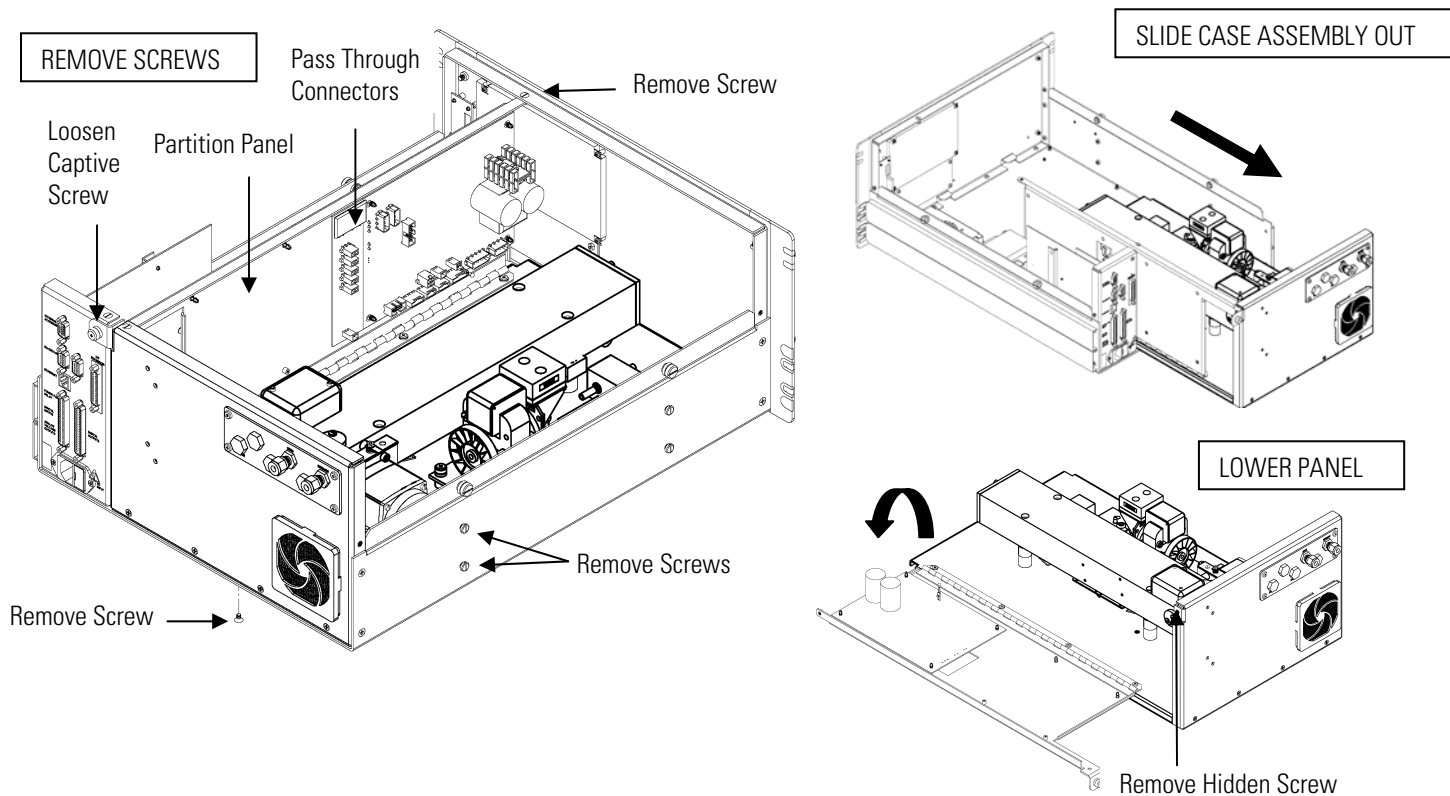

Figure 7-3. Removing the Measurement Case Assembly and Lowering the Partition Panel

Equipment Required:

Philips screwdriver



Equipment Damage Some internal components can be damaged by small amounts of static electricity. A properly grounded antistatic wrist strap must be worn while handling any internal component. ▲

1. Turn the instrument OFF and unplug the power cord.
2. If the instrument is mounted in a rack, remove it from the rack.

3. Remove the cover.
4. Disconnect the three connectors that pass through the center of the partition panel that connect to the measurement interface board.
5. Remove two screws from the left side rear of the case (viewed from front).
6. Remove one screw from the bottom rear of the case.
7. Remove one screw from the top front of the partition panel.
8. While holding the case securely, loosen the captive screw at the rear of the measurement case assembly, and pull the measurement case assembly from the rear of the case.
9. Remove the screw at the top rear of the partition panel that secures the top of the panel to the measurement case assembly, and lower the panel, being careful not to put excessive tension on the cables.
10. Re-install the measurement case assembly by following the previous steps in reverse.

Fuse Replacement

Use the following procedure to replace the fuses.

Equipment Required:

Replacement fuses:

250VAC, 3 Amp, SlowBlow (for 100VAC and 110VAC models)

250VAC, 1.60 Amp, SlowBlow (for 220-240VAC models)

1. Turn the instrument OFF and unplug the power cord.
2. Remove fuse drawer, located on the AC power connector.
3. If either fuse is blown, replace both fuses.
4. Insert fuse drawer and reconnect power cord.

Fan/Filter Replacement

Use the following procedure to replace the fan and the fan filter (Figure 7–4).

Equipment Required:

- Fan
- Fan filter
- Philips screwdriver
- Adjustable wrench



Equipment Damage Some internal components can be damaged by small amounts of static electricity. A properly grounded antistatic wrist strap must be worn while handling any internal component. ▲

1. Turn the instrument OFF, unplug the power cord, and remove the cover.
2. Remove the fan guard and filter from the rear of the instrument by unsnapping it.
3. If the fan is not being replaced, install the new filter, snap it into place, and skip the remaining steps.
4. If possible, disconnect the fan power cable from the fan, otherwise disconnect the cable from the measurement interface board.
5. Remove the four fan mounting screws along with nuts and washers and remove the fan.
6. Install a new fan following the previous steps in reverse order.

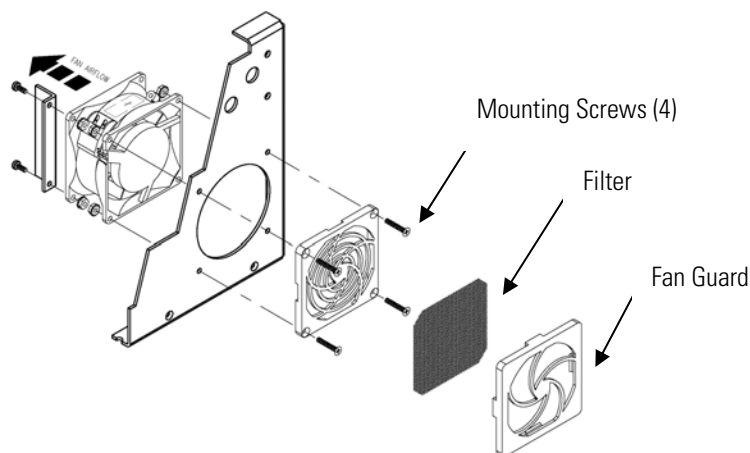

Figure 7-4. Replacing the Fan

IR Source Replacement

Use the following procedure to replace the IR source (Figure 7-5).

Equipment Required:

IR Source

Flatblade screwdriver



Equipment Damage Some internal components can be damaged by small amounts of static electricity. A properly grounded antistatic wrist strap must be worn while handling any internal component. ▲

1. Turn the instrument OFF, unplug the power cord, and remove the cover.
2. Remove the two cover screws holding the IR source cover to the motor plate and remove the IR source cover (Figure 7-5).
3. Loosen both clamp screws from the IR source mounting posts and remove IR source.
4. Install a new IR source by following the previous steps in reverse. Ensure that the IR source element is evenly spaced between the mounting posts.

Servicing

Filter Wheel Replacement

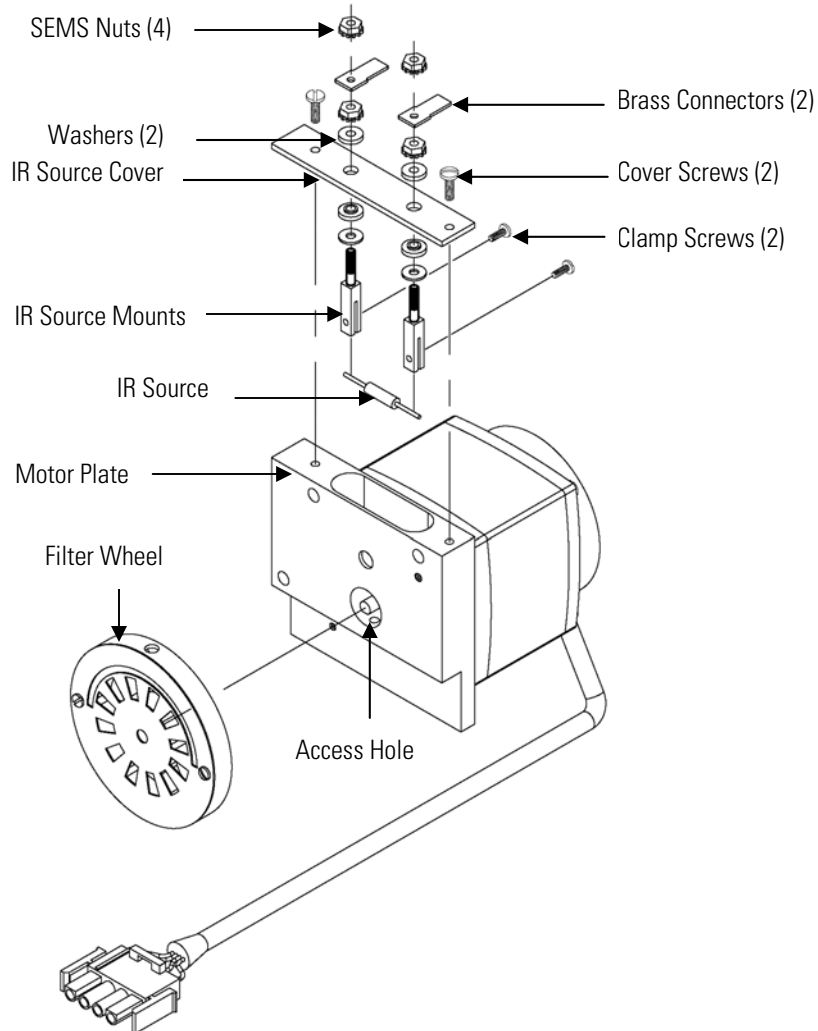

Figure 7-5. Replacing the IR Source

Filter Wheel Replacement

Use the following procedure to replace the filter wheel.

Equipment Required:

Filter wheel

Allen wrenches, 5/32-inch and 5/64-inch

Philips screwdriver



Equipment Damage Some internal components can be damaged by small amounts of static electricity. A properly grounded antistatic wrist strap must be worn while handling any internal component. ▲

1. Turn the instrument OFF, unplug the power cord, and remove the cover.
2. Remove the chopper motor and wheel assembly by removing the three motor plate Allen screws holding the motor plate to the optical bench (Figure 7–6).

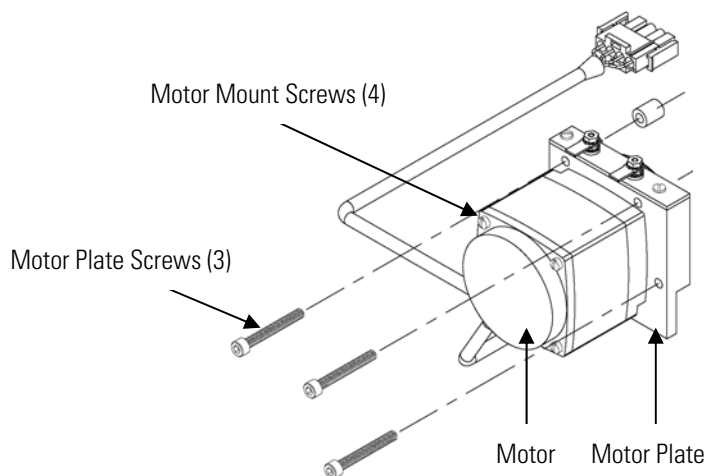



Figure 7–6. Removing the Motor

3. Remove the cross recessed screw on the bottom of the motor plate.
4. Insert the 5/64-inch Allen wrench through the access hole in the bottom of the motor plate, loosen the set screw holding the filter wheel to the motor shaft, and **carefully** pry the filter wheel off the motor shaft (Figure 7–5).
5. Install new filter wheel by following the previous steps in reverse. Make sure that the set screw seats on the flat of the motor shaft.
6. After the filter wheel is installed, spin the wheel and observe that it runs true on the motor shaft.
7. Let the instrument sample zero air for about 90 minutes.
8. From the Main Menu, choose Service > **Initial S/R Ratio**.
The Initial S/R Ratio screen appears.

Note If Service Mode is not displayed, refer to “[Accessing the Service Mode](#)” on page 7-4, then return to the beginning of this step. ▲

9. At the Initial S/R Ratio screen, press  to select set the initial S/R ratio to the value of the current ratio and press to store the value. The initial S/R ratio should be between 1.14 and 1.18.
10. Calibrate the instrument. Refer to the “[Calibration](#)” chapter in this manual.

Chopper Motor Replacement

Use the following procedure to replace the chopper motor ([Figure 7-6](#)).

Equipment Required:

- Chopper motor
- Allen wrenches, 5/32-inch and 5/64-inch
- Flatblade screwdriver



Equipment Damage Some internal components can be damaged by small amounts of static electricity. A properly grounded antistatic wrist strap must be worn while handling any internal component. ▲

1. Disconnect the chopper motor power cable from the MOT DRV connector on the measurement interface board.
2. Follow the directions for “[Filter Wheel Replacement](#)” procedure, up to and including Step 3.
3. Remove the chopper motor from the motor plate by removing the two screws that hold it to the motor plate.
4. Install the new chopper motor by following the previous steps in reverse.
5. Install the filter wheel on the motor shaft, make sure that the set screw seats on the flat of the motor shaft, and tighten the set screw.
6. Calibrate the instrument. Refer to the “[Calibration](#)” chapter in this manual.

Optical Bench Replacement

Use the following procedure to replace the optical bench (Figure 7-7).

Equipment Required:

Optical bench

Philips screwdriver



Equipment Damage Some internal components can be damaged by small amounts of static electricity. A properly grounded antistatic wrist strap must be worn while handling any internal component. ▲

1. Turn the instrument OFF, unplug the power cord, and remove the cover.
2. Disconnect the chopper motor cable from the MOT DRV connector on the measurement interface board, and disconnect the detector cable from the PREAMP cable connector on the measurement interface board.
3. Disconnect the plumbing connections from the optical bench.
4. Remove the four screws holding the optical bench to the shock mounts and carefully remove the optical bench.
5. Replace the optical bench by following the previous steps in reverse.
6. Calibrate the instrument. Refer to the “[Calibration](#)” chapter in this manual.

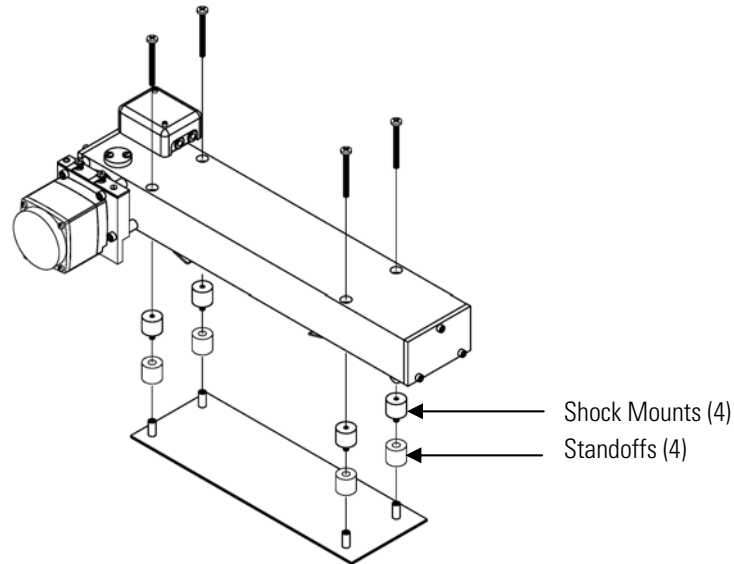

Figure 7-7. Replacing the Optical Bench

Optical Switch Replacement

Use the following procedure to replace the optical switch (Figure 7-8).

Equipment Required:

Optical switch

Flatblade screwdriver, 1/4-inch and 3/16-inch

Philips screwdriver



Equipment Damage Some internal components can be damaged by small amounts of static electricity. A properly grounded antistatic wrist strap must be worn while handling any internal component. ▲

1. Turn the instrument OFF, unplug the power cord, and remove the cover.
2. Remove the optical bench following the “[Optical Bench Replacement](#)” procedure in this chapter.
3. Turn the optical bench over, remove the two screws securing the optical switch assembly to the case, and remove the optical switch.
4. Install the new optical switch by following the previous steps in reverse.

5. Calibrate the instrument. Refer to the “[Calibration](#)” chapter in this manual.

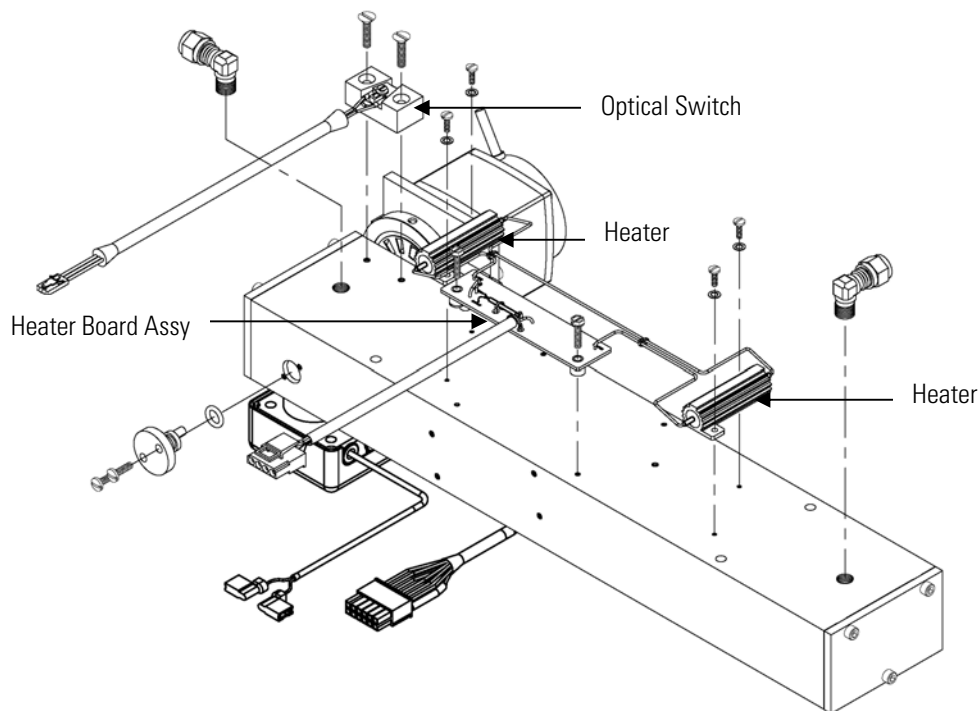

Figure 7–8. Replacing the Optical Switch (Inverted View)

Bench Heater Assembly Replacement

Use the following procedure to replace the bench heater assembly ([Figure 7–8](#)).

Equipment Required:

- Bench heater
- Heat conductive compound
- Flatblade screwdriver, 1/4-inch



Equipment Damage Some internal components can be damaged by small amounts of static electricity. A properly grounded antistatic wrist strap must be worn while handling any internal component. ▲

1. Turn the instrument OFF, unplug the power cord, and remove the cover.
2. Remove the optical bench following the “[Optical Bench Replacement](#)” procedure in this chapter.

Servicing

Detector/Preamplifier Assembly Replacement

3. Remove the two screws holding each heater to the bottom of the optical bench, and remove both heaters and the heater board assembly.
4. Apply heat conductive compound to the bottom of the heaters and install the new heaters and heater board assembly.
5. Calibrate the instrument. Refer to the “[Calibration](#)” chapter in this manual.

Detector/Preamplifier Assembly Replacement

Use the following procedure to replace the detector/preamplifier assembly (Figure 7-9).

Equipment Required:

detector/preamplifier assembly

Allen wrenches, 3/32-inch and 7/64-inch



Equipment Damage Some internal components can be damaged by small amounts of static electricity. A properly grounded antistatic wrist strap must be worn while handling any internal component. ▲

1. Turn the instrument OFF, unplug the power cord, and remove the cover.
2. Disconnect the cable from the PREAMP connector on the measurement interface board and disconnect the two wires from the top of the chopper motor plate.

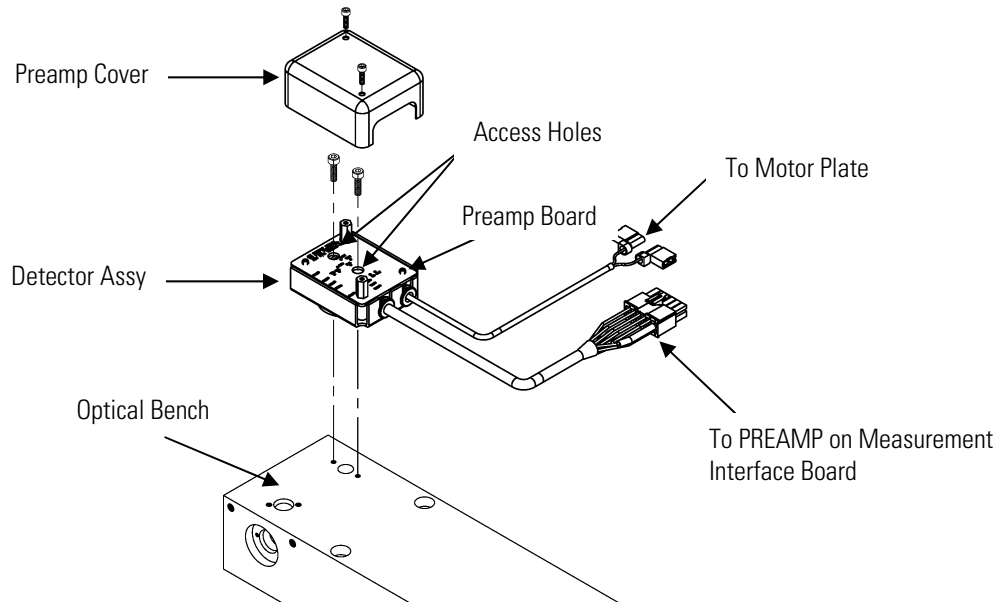



Figure 7–9. Replacing the Detector/Preamplifier Assembly

3. Remove the two screws holding the preamplifier cover to the preamplifier assembly and remove the cover.
4. Insert an Allen wrench through the access holes in the preamplifier printed circuit board, and remove the screws holding the detector assembly to the optical bench. Carefully remove the detector assembly from the optical bench.
5. Install the new detector assembly by following the previous steps in reverse.
6. Calibrate the preamp board, and then return to Step 7 to set S/R. Refer to the “[Preamp Board Calibration](#)” procedure that follows.
7. Set S/R as follows:
 - a. From the Main Menu, choose Service > **Initial S/R Ratio**.
The Initial S/R Ratio screen appears.
 - b. At the Initial S/R Ratio screen, press  to select set the initial S/R ratio to the value of the current ratio and press to store the value. The initial S/R ratio should be between 1.14 and 1.18.

Note If Service Mode is not displayed, refer to “[Accessing the Service Mode](#)” on page 7-4, then return to the beginning of this step. ▲

8. Calibrate the instrument. Refer to the “[Calibration](#)” chapter in this manual.

Preamp Board Calibration



Use the following procedure to calibrate the preamp board.



Equipment Damage This adjustment should only be performed by an instrument service technician. ▲

1. Let the instrument sample zero air for about 90 minutes.
2. From the Main Menu, choose Service > **Preamp Board Calibration**.
The Preamp Board Cal screen appears.

Note If Service Mode is not displayed, refer to “[Accessing the Service Mode](#)” on page 7-4, then return to the beginning of this step. ▲

3. At the Preamp Board Cal screen, use   until either the Sample or Reference value reads more than 150,000 then press  to save the value.

Pump Replacement

Use the following procedure to rebuild the pump ([Figure 7-10](#)).

Equipment Required:

- Pump
- Nut driver
- Philips screwdriver, #2



Equipment Damage Some internal components can be damaged by small amounts of static electricity. A properly grounded antistatic wrist strap must be worn while handling any internal component. ▲

1. Turn the instrument OFF, unplug the power cord, and remove the cover.

2. Disconnect the pump power cable from the AC PUMP connector on the measurement interface board.
3. Remove both lines from the pump.
4. Loosen the four captive screws holding the pump bracket to the shock mounts and remove the pump assembly and the shock mounts.
5. Invert the pump assembly, remove the two pump mounting screws located on the bottom side of the pump bracket, and remove the bracket from the pump.
6. Install the new pump by following the previous steps in reverse.
7. Perform a leak test as described in the “[Preventive Maintenance](#)” chapter.

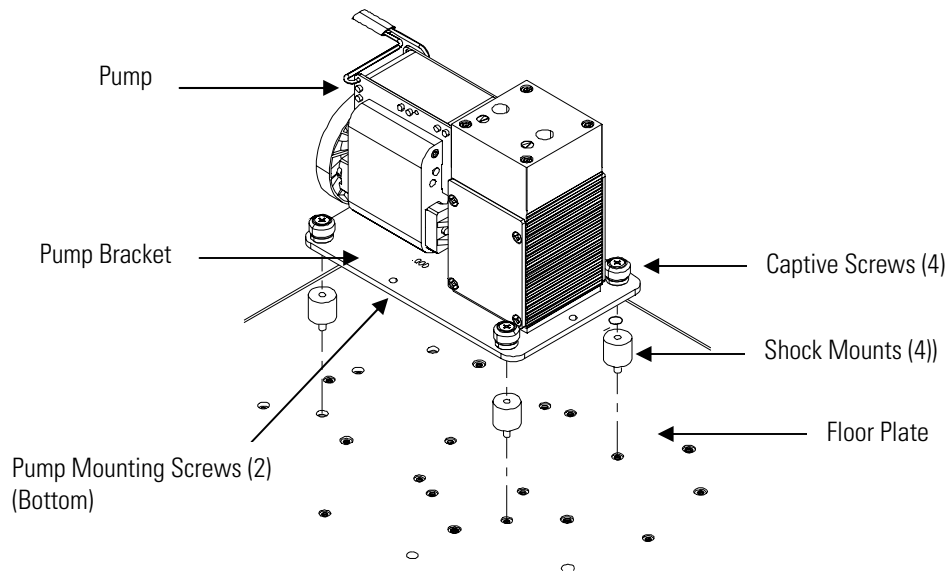

Figure 7–10. Replacing the Pump

Pressure Transducer Replacement

Use the following procedure to replace the pressure transducer ([Figure 7–11](#)).

Equipment Required:

Pressure transducer

Philips screwdriver, #2



Equipment Damage Some internal components can be damaged by small amounts of static electricity. A properly grounded antistatic wrist strap must be worn while handling any internal component. ▲

1. Turn the instrument OFF, unplug the power cord, and remove the cover.
2. Disconnect plumbing from the pressure transducer assembly (Figure 7–2). Note the plumbing connections to facilitate reconnection.
3. Disconnect the pressure transducer from the PRES connector on the measurement interface board.
4. Remove the two pressure transducer assembly retaining screws and remove the pressure transducer assembly (Figure 7–11).

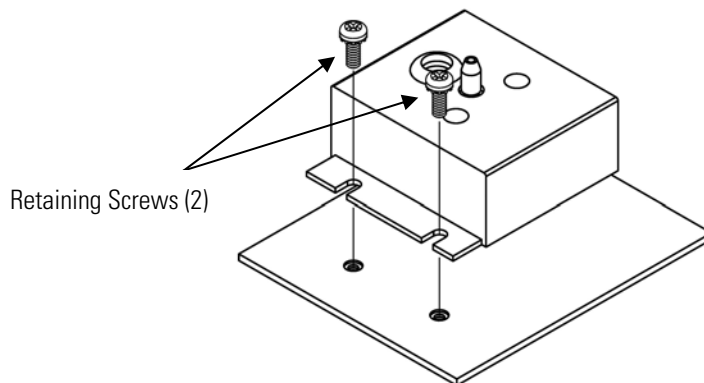

Figure 7–11. Replacing the Pressure Transducer

5. To install the pressure transducer assembly, follow the previous steps in reverse.
6. Calibrate the pressure transducer. Refer to the “[Flow Transducer Calibration](#)” procedure that follows.

Pressure Transducer Calibration

Use the following procedure to calibrate the pressure transducer.

Note An error in the zero setting of the pressure transducer does not introduce a measurable error in the output concentration reading.

Therefore, if only a barometer is available and not a vacuum pump, only adjust the span setting. ▲

A rough check of the pressure accuracy can be made by obtaining the current barometric pressure from the local weather station or airport and comparing it to the pressure reading. However, since these pressures are usually corrected to sea level, it may be necessary to correct the reading to local pressure by subtracting 0.027 mmHg per foot of altitude. ▲

Do not attempt to calibrate the pressure transducer unless the pressure is known accurately. ▲

Equipment Required:

Vacuum pump



WARNING The service procedures in this manual are restricted to qualified service representatives. ▲

If the equipment is operated in a manner not specified by the manufacturer, the protection provided by the equipment may be impaired. ▲



Equipment Damage Some internal components can be damaged by small amounts of static electricity. A properly grounded antistatic wrist strap must be worn while handling any internal component. ▲









1. Remove the instrument cover.
2. Disconnect the tubing from the pressure transducer and connect a vacuum pump known to produce a vacuum less than 1 mmHg.
3. From the Main Menu, choose Service > **Pressure Calibration**.
The Pressure Sensor Cal screen appears.

Note If Service Mode is not displayed, refer to “[Accessing the Service Mode](#)” on page 7-4, then return to the beginning of this step. ▲

4. At the Pressure Sensor Cal screen, press  to select **Zero**.
The Calibrate Pressure Zero screen appears.

Servicing

Flow Transducer Replacement

5. Wait at least 10 seconds for the zero reading to stabilize, and then press  to save the zero pressure value.
6. Disconnect the pump from the pressure transducer.
7. Press  to return to the Pressure Sensor Cal screen.
8. At the Pressure Sensor Cal screen, press   to select **Span**.
The Calibrate Pressure Span screen appears.
9. Wait at least 10 seconds for the ambient reading to stabilize, use   and   to enter the known barometric pressure, and press  to save the pressure value.
10. Reconnect the instrument tubing to the pressure transducer.
11. Install the cover.

Flow Transducer Replacement

Use the following procedure to replace the flow transducer (Figure 7–12).

Equipment Required:

Flow transducer

Philips screwdriver, #2



Equipment Damage Some internal components can be damaged by small amounts of static electricity. A properly grounded antistatic wrist strap must be worn while handling any internal component. ▲

1. Turn the instrument OFF, unplug the power cord, and remove the cover.
2. Disconnect flow transducer cable from the FLOW connector on the measurement interface board (Figure 7–2).
3. Disconnect the plumbing connections from the flow transducer. Note the plumbing connections to facilitate reconnection.

4. Remove the two retaining screws holding the flow transducer to the floor plate and remove the flow transducer (Figure 7–12).

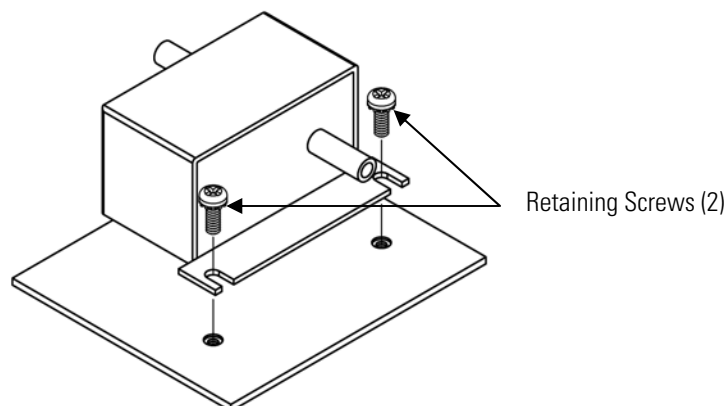

Figure 7–12. Replacing the Flow Transducer

5. Install the new flow transducer following the previous steps in reverse.
6. Calibrate the flow transducer. Refer to the “[Flow Transducer Calibration](#)” procedure that follows.

Flow Transducer Calibration

Use the following procedure to calibrate the flow transducer.

Equipment Required:

Calibrated flow sensor



WARNING The service procedures in this manual are restricted to qualified service representatives. ▲

If the equipment is operated in a manner not specified by the manufacturer, the protection provided by the equipment may be impaired. ▲



Equipment Damage Some internal components can be damaged by small amounts of static electricity. A properly grounded antistatic wrist strap must be worn while handling any internal component. ▲

1. Remove the instrument cover.
2. Disconnect the pump cable from AC PUMP connector on the measurement interface board.

Servicing

Capillary Cleaning or Replacement

3. From the Main Menu, choose Service > **Flow Calibration**.

The Flow Sensor Cal screen appears.

Note If Service Mode is not displayed, refer to “[Accessing the Service Mode](#)” on page 7-4, then return to the beginning of this step. ▲

4. At the Flow Sensor Cal screen, press  to select **Zero**.



The Calibrate Flow Zero screen appears.

5. Wait at least 10 seconds for the zero reading to stabilize, and then press  to save the zero flow value.





6. Reconnect the pump cable to the AC PUMP connector on the measurement interface board.

7. Connect a calibrated flow sensor at the SAMPLE bulkhead on the rear panel.

8. Press  to return to the Flow Sensor Cal screen.

9. At the Flow Sensor Cal screen, press   to select **Span**.

The Calibrate Flow Span screen appears.

10. Wait at least 10 seconds for the reading to stabilize, use   and   to enter the flow sensor reading, and press  to save the value.

11. Install the cover.

Capillary Cleaning or Replacement

Use the following procedure to clean or replace the capillary ([Figure 7-13](#)).

Equipment Required:

Wrench, 5/8-inch

Capillary

Capillary cleaning wire (smaller than 0.015-inch)



Equipment Damage Some internal components can be damaged by small amounts of static electricity. A properly grounded antistatic wrist strap must be worn while handling any internal component. ▲

1. Turn the instrument OFF, unplug the power cord, and remove the cover.
2. Remove the capillary from the inlet elbow fitting on the pump head.

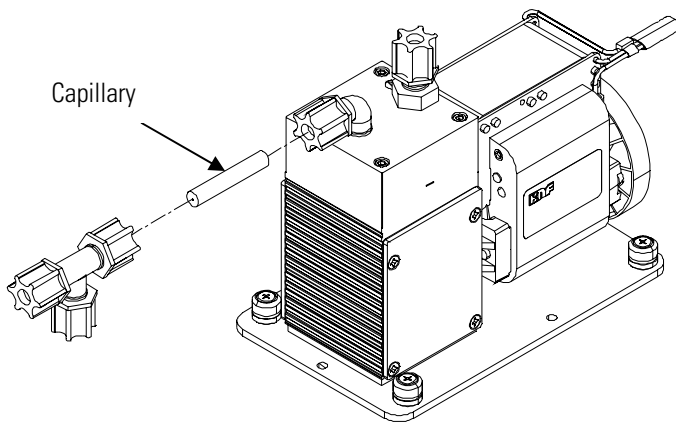

Figure 7–13. Cleaning or Replacing the Capillary

3. Clean with less than 0.015-inch diameter wire or replace.
4. Install the capillary by following the previous steps in reverse.

Optional Zero/Span and Sample Solenoid Valve Replacement

Use the following procedure to replace the solenoid.

Equipment Required:

Solenoid

Philips screwdriver, #2

Wrench, 9/16-inch



Equipment Damage Some internal components can be damaged by small amounts of static electricity. A properly grounded antistatic wrist strap must be worn while handling any internal component. ▲

1. Turn the instrument OFF, unplug the power cord, and remove the cover.
2. Unplug the solenoid electrical connector from the measurement interface board.
3. Remove the Teflon® lines from the solenoid.
4. Remove both screws holding the solenoid to the rear panel, and remove the solenoid.
5. Install the solenoid by following the previous steps in reverse.
6. Perform a leak test as described in the “[Preventive Maintenance](#)” chapter.



Analog Output Testing

The analog outputs should be tested if the concentration value on the front panel display disagrees with the analog outputs. To check the analog outputs, connect a meter to an analog output channel (voltage or current) and compare the meter reading with the output value set on the Test Analog Outputs screen.

Equipment Required:

Multimeter

Use the following procedure to test the analog outputs.

1. Connect a meter to the channel to be tested. [Figure 7-14](#) shows the analog output pins and [Table 7-4](#) identifies the associated channels.
2. From the Main Menu, choose Diagnostics > **Test Analog Outputs**.
The Test Analog Outputs screen appears.
3. Press  to scroll to the desired channel corresponding to the rear panel terminal pins where the meter is connected, and press .

Note The pin numbers on the connector do not match the pin numbers on the terminal boards. Refer to [Table 2–1](#) through [Table 2–3](#) for information on the pin to terminal board relationship. ▲

Table 7–4. Analog Output Channels and Rear Panel Pin Connections

Voltage Channel	Pin	Current Channel	Pin
1	14	1	15
2	33	2	17
3	15	3	19
4	34	4	21
5	17	5	23
6	36	6	25
Ground	16, 18, 19, 35, 37	Current Output Return	16, 18, 20, 22, 24

Table 7–5. Analog Input Channels and Rear Panel Pin Connections

Input Channel	Pin
1	1
2	2
3	3
4	5
5	6
6	7
7	9
8	10
Ground	4, 8, 11

Analog Output Calibration

Use the following procedure to calibrate the analog outputs if a meter reading in the “[Analog Output Testing](#)” procedure differed by more than one percent or after replacing the optional I/O expansion board.

Equipment Required:



Multimeter

1. Connect a meter to the channel to be adjusted and set to voltage or current as appropriate. [Figure 7-14](#) shows the analog output pins and [Table 7-4](#) identifies the associated channels.

2. From the Main Menu, choose Service > **Analog Out Cal.**

The Analog Output Cal screen appears.



Note If Service Mode is not displayed, refer to “[Accessing the Service Mode](#)” on page 7-4, then return to the beginning of this step. ▲

3. At the Analog Output Cal menu, press  to scroll to the desired voltage channel or current channel corresponding to the rear panel terminal pin where the meter is connected, then press .



4. With the cursor at Calibrate Zero, press .

The Analog Output Cal line displays Zero.

Note When calibrating the analog output, always calibrate zero first and then calibrate full-scale. ▲

5. Use   until the meter reads the value shown in the Set Output To line (0.0 V, or 0.0 or 4.0 mA), then press  to save the value.

6. Press  to return to the previous screen.

7. Press   to select Calibrate Full Scale.

8. Use   until the meter reads the value shown in the Set Output To line, then press  to save the value.

Analog Input Calibration



Use the following procedures to calibrate the analog inputs after replacing the optional I/O expansion board. These procedures include selecting analog input channels, calibrating them to zero volts, and then calibrating them to full scale using a known voltage source.

Calibrating the Input Channels to Zero Volts

Use the following procedure to calibrate the input channels to zero volts.

1. From the Main Menu, choose Service > **Analog Input Calibration**.
The Analog Input Cal screen displays.

Note If Service Mode is not displayed, refer to “[Accessing the Service Mode](#)” on page 7-4, then return to the beginning of this step. ▲



2. At the Analog Input Cal screen, press  to scroll to a channel, and press .

3. With the cursor at Calibrate Zero, press .

The screen displays the input voltage for the selected channel.

4. Make sure that nothing is connected to the channel input pins and press  to calibrate the input voltage on the selected channel to zero volts.

The screen displays 0.00 V as the voltage setting.

5. Press  >  to return to the Analog Input Cal screen and repeat Steps 2 through 4 to calibrate other input channels to zero as necessary.

6. Continue with the “[Calibrating the Input Channels to Full-Scale](#)” procedure that follows.











Calibrating the Input Channels to Full-Scale

Use the following procedure to calibrate the input channels to full-scale by applying a known voltage to the channels.

Equipment Required:

DC voltage source (greater than 0 volts and less than 10 volts)

1. Connect the known DC voltage source to the input channel (1-8) to be calibrated. [Figure 7-14](#) shows the analog input pins and [Table 7-5](#) identifies the associated channels.
2. From the Main Menu, choose Service > **Analog Input Calibration**.
The Analog Input Cal screen displays input channels 1-8.

3. At the Analog Input Cal screen, press  to scroll to the channel selected in Step 1, and press .
4. Press  to scroll to Calibrate Full-scale, and press .
The screen displays the current input voltage for the selected channel.
5. Use   and   to enter the source voltage, and press  to calibrate the input voltage for the selected channel connected to the source voltage.
6. Press  >  to return to the input channels display and repeat Steps 3-5 to calibrate other input channels to the source voltage as necessary.

Ambient Temperature Calibration

Use the following procedure to calibrate the ambient internal temperature for the instrument.

Equipment Required:

Calibrated thermometer or 10K ohm $\pm 1\%$ resistor



WARNING The service procedures in this manual are restricted to qualified service representatives. ▲

If the equipment is operated in a manner not specified by the manufacturer, the protection provided by the equipment may be impaired. ▲



Equipment Damage Some internal components can be damaged by small amounts of static electricity. A properly grounded antistatic wrist strap must be worn while handling any internal component. ▲

1. Remove the instrument cover.
2. Tape the thermometer to the thermistor, which is plugged into the measurement interface board ([Figure 7-3](#)).

Note Since the thermistors are interchangeable to an accuracy of ± 0.2 °C, and have a value of 10K ohms at 25 °C, an alternate procedure is to connect an accurately known 10K resistor to the thermistor input (AMB





TEMP) on the measurement interface board, and enter the temperature reading. ▲

A 1 °C change corresponds to a ±5% change in resistance, thus this alternative procedure can be quite accurate as a check; however, it clearly is not NIST traceable. ▲

3. From the Main Menu, choose Service > **Temperature Calibration**.

The Calibrate Ambient Temperature screen appears.

Note If Service Mode is not displayed, refer to “[Accessing the Service Mode](#)” on page 7-4, then return to the beginning of this step. ▲

4. Wait at least 10 seconds for the ambient reading to stabilize, use   and   to enter the known temperature, and press  to save the temperature value.

5. Install the cover.

I/O Expansion Board (Optional) Replacement

Use the following procedure to replace the optional I/O expansion board (Figure 7-15).

Note After replacing the optional I/O expansion board, calibrate the current outputs and the analog voltage inputs. See “[Analog Output Calibration](#)” on page 7-30 and “[Analog Input Calibration](#)” on page 7-31 in this chapter. ▲

Equipment Required:

I/O expansion board

Nut driver, 3/16-inch



Equipment Damage Some internal components can be damaged by small amounts of static electricity. A properly grounded antistatic wrist strap must be worn while handling any internal component. ▲

1. Turn the instrument OFF, unplug the power cord, and remove the cover.

2. Unplug the I/O expansion board cable from the EXPANSION BD connector on the motherboard.
3. Remove the two standoffs holding the I/O expansion board connector to the rear panel (Figure 7-16).
4. Pop off the board from the mounting studs and remove the board.
5. To install the I/O expansion board, follow the previous steps in reverse.

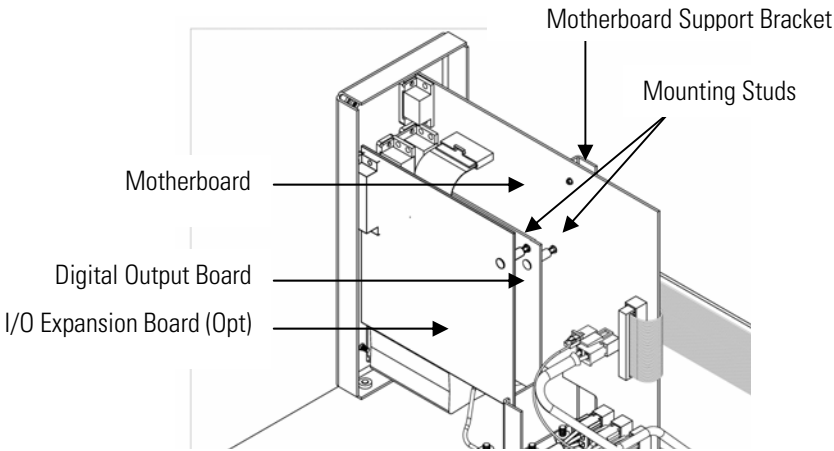

Figure 7-15. Replacing the I/O Expansion Board (Optional)

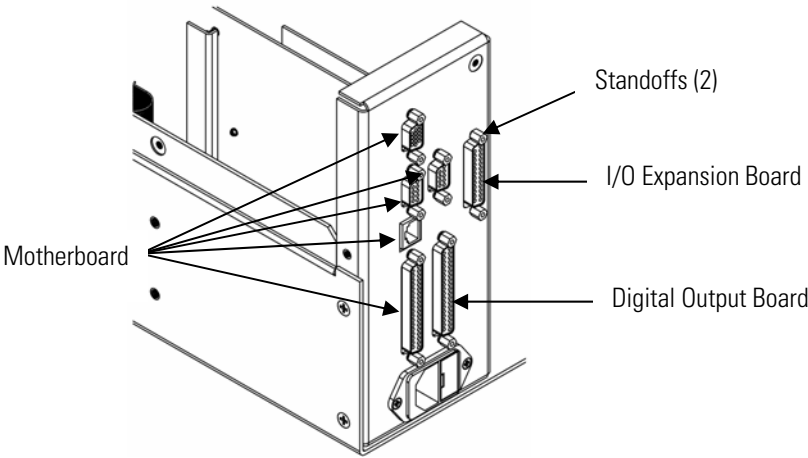

Figure 7-16. Rear Panel Board Connectors

Internal O₂ Sensor (Optional) Replacement

Use the following procedure to replace the optional internal O₂ sensor (see [Figure 7–2](#)).

Equipment Required:

O₂ sensor

Philips screwdriver

Wrench, 7/16-inch



Equipment Damage Some internal components can be damaged by small amounts of static electricity. A properly grounded antistatic wrist strap must be worn while handling any internal component. ▲

1. Turn the instrument OFF, unplug the power cord, and remove the cover.
2. Disconnect the oxygen sensor ribbon cable.
3. Disconnect all plumbing connections from the oxygen sensor.
4. Loosen the four captive screws holding the converter to the floor plate and move it to the front of the case.
5. Loosen the three captive screws holding the oxygen sensor to the floor plate and remove the oxygen sensor.
6. Install new oxygen sensor by following the previous steps in reverse.

Digital Output Board Replacement

Use the following procedure to replace the digital output board ([Figure 7–15](#)).

Equipment Required:

Digital output board

Nut driver, 3/16-inch



Equipment Damage Some internal components can be damaged by small amounts of static electricity. A properly grounded antistatic wrist strap must be worn while handling any internal component. ▲

1. Turn the instrument OFF, unplug the power cord, and remove the cover.
2. Remove the I/O expansion board (optional), if used. See “[I/O Expansion Board \(Optional\) Replacement](#)” on page 7-34.
3. Disconnect the digital output board ribbon cable from the motherboard.
4. Using the nut driver, remove the two standoffs securing the board to the rear panel ([Figure 7-16](#)).
5. Pop off the digital output board from the mounting studs and remove the board.
6. To install the digital output board, follow the previous steps in reverse.

Motherboard Replacement

Use the following procedure to replace the motherboard ([Figure 7-15](#)).

Equipment Required:

Motherboard

Philips screwdriver

Nut driver, 3/16-inch



Equipment Damage Some internal components can be damaged by small amounts of static electricity. A properly grounded antistatic wrist strap must be worn while handling any internal component. ▲

1. Turn the instrument OFF, unplug the power cord, and remove the cover.
2. Remove the I/O expansion board (optional), if used. See “[I/O Expansion Board \(Optional\) Replacement](#)” on page 7-34.
3. Remove the digital output board. See “[Digital Output Board Replacement](#)” on page 7-36.
4. Unplug all connectors from the motherboard. Note connector locations to facilitate reconnection.

5. Using the nut driver, remove the six standoffs securing the board to the rear panel.
6. Pop the motherboard off of the support bracket, and remove the motherboard.
7. To install the motherboard, follow the previous steps in reverse.
8. Calibrate the analog voltage outputs as defined earlier in this chapter (all ranges).

Measurement Interface Board Replacement

Use the following procedure to replace the measurement interface board (Figure 7-17).

Equipment Required:

Measurement interface board

Philips screwdriver, #2



Equipment Damage Some internal components can be damaged by small amounts of static electricity. A properly grounded antistatic wrist strap must be worn while handling any internal component. ▲

1. Remove the measurement bench and lower the partition panel to gain access to the measurement interface board connectors and standoffs. Refer to “[Removing the Measurement Case Assembly and Lowering the Partition Panel](#)” on page 7-8.
2. Unplug all connectors from the measurement interface board (Figure 7-17). Note the locations of the connectors to facilitate reconnection.
3. Unscrew the two screws at the top of the measurement interface board. Pop the measurement interface board off of the two bottom mounting studs and remove the board.
4. To install the measurement interface board, follow the previous steps in reverse.
5. Re-install the measurement case assembly. Refer to “[Removing the Measurement Case Assembly and Lowering the Partition Panel](#)” on page 7-8 in this chapter.

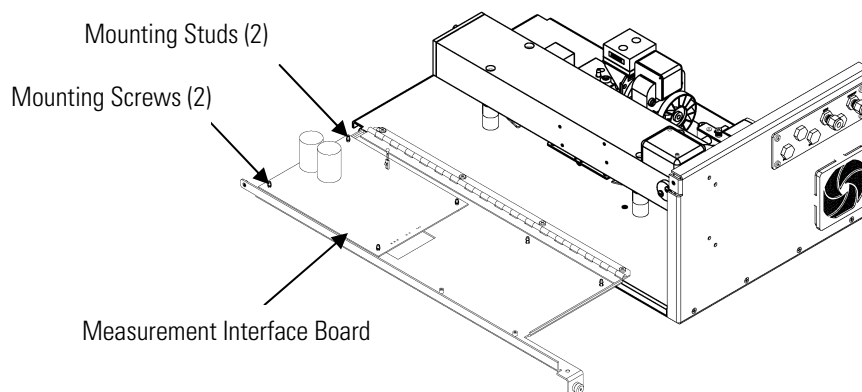

Figure 7–17. Replacing the Measurement Interface Board

Front Panel Board Replacement

Use the following procedure to replace the front panel board (Figure 7–18).

Equipment Required:

Front panel board



Equipment Damage Some internal components can be damaged by small amounts of static electricity. A properly grounded antistatic wrist strap must be worn while handling any internal component. ▲

1. Turn the instrument OFF, unplug the power cord, and remove the cover.
2. Remove the three ribbon cables and the two-wire connector from the front panel board.
3. Pop off the board from the two top mounting studs and remove the board by lifting it up and off the slotted bottom support.
4. Replace the front panel board by following the previous steps in reverse.

Servicing

LCD Module Replacement

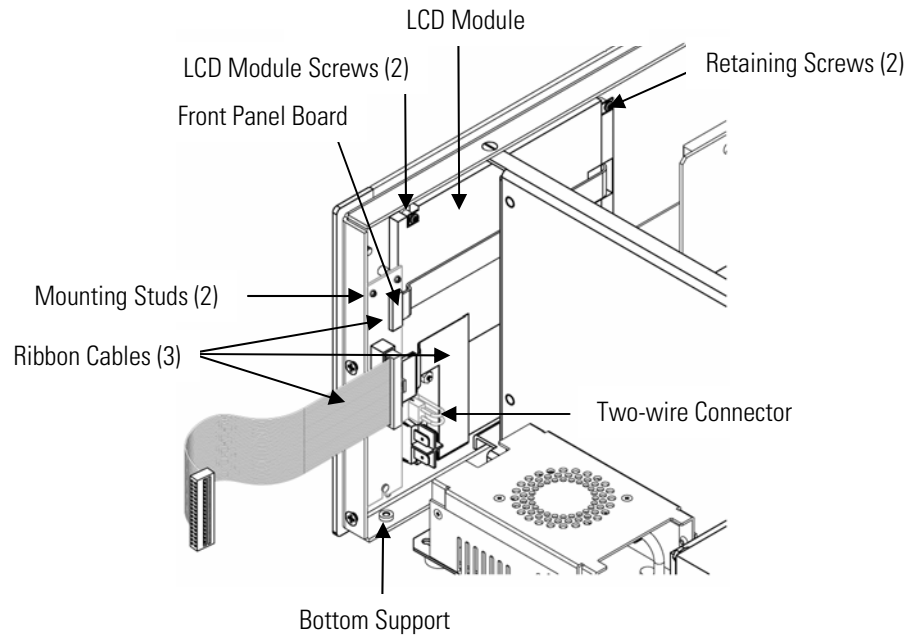

Figure 7–18. Replacing the Front Panel Board and the LCD Module

LCD Module Replacement

Use the following procedure to replace the LCD module (Figure 7–18).

Equipment Required:

LCD module

Philips screwdriver



CAUTION If the LCD panel breaks, do not let the liquid crystal contact your skin or clothes. If the liquid crystal contacts your skin or clothes, wash immediately using soap and water. ▲



Equipment Damage Some internal components can be damaged by small amounts of static electricity. A properly grounded antistatic wrist strap must be worn while handling any internal component. ▲

Do not remove the LCD panel or frame from the LCD module. ▲

The LCD polarizing plate is very fragile, handle it carefully. ▲

Do not wipe the LCD polarizing plate with a dry cloth, as it may easily scratch the plate. ▲

Do not use alcohol, acetone, MEK or other Ketone based or aromatic solvents to clean the LCD module, but rather use a soft cloth moistened with a naphtha cleaning solvent. ▲

Do not place the LCD module near organic solvents or corrosive gases. ▲

Do not shake or jolt the LCD module. ▲

1. Turn the instrument OFF, unplug the power cord, and remove the cover.
2. Disconnect the ribbon cable and the two-wire connector from the front panel board.
3. Remove the four screws at the corners of the LCD module.
4. Slide the LCD module out towards the center of the instrument.
5. Replace the LCD module by following the previous steps in reverse.

Note The optimal contrast will change from one LCD screen to another. After replacing the LCD screen, the contrast may need to be reset. If the content on the screen is visible, select Instrument Controls > **Screen Contrast** and adjust the screen contrast. If the content on the screen is not visible, use the “set contrast 10” C-Link command to set screen contrast to mid range, then optimize the contrast. See the “C-Link Protocol Commands” appendix for more information on this command. ▲

Service Locations

For additional assistance, service is available from exclusive distributors worldwide. Contact one of the phone numbers below for product support and technical information or visit us on the web at www.thermo.com/aqi.

1-866-282-0430 Toll Free

1-508-520-0430 International

Chapter 8

System Description

This chapter describes the function and location of the system components, provides an overview of the firmware structure, and includes a description of the system electronics and input/output connections and functions as follows:

- “[Hardware](#)” on page 8-1
- “[Firmware](#)” on page 8-3
- “[Electronics](#)” on page 8-5
- “[I/O Components](#)” on page 8-8

Hardware

Model 48*i* hardware components ([Figure 8–1](#)) include:

- Optical bench
- Band-pass filter
- Bench heater board
- Chopper motor
- Optical pickup
- Gas filter wheel
- Infrared source
- Pre-amplifier assembly with IR detector
- Sample flow sensor
- Pressure transducer
- Capillary
- Pump
- Purge flow switch (optional)

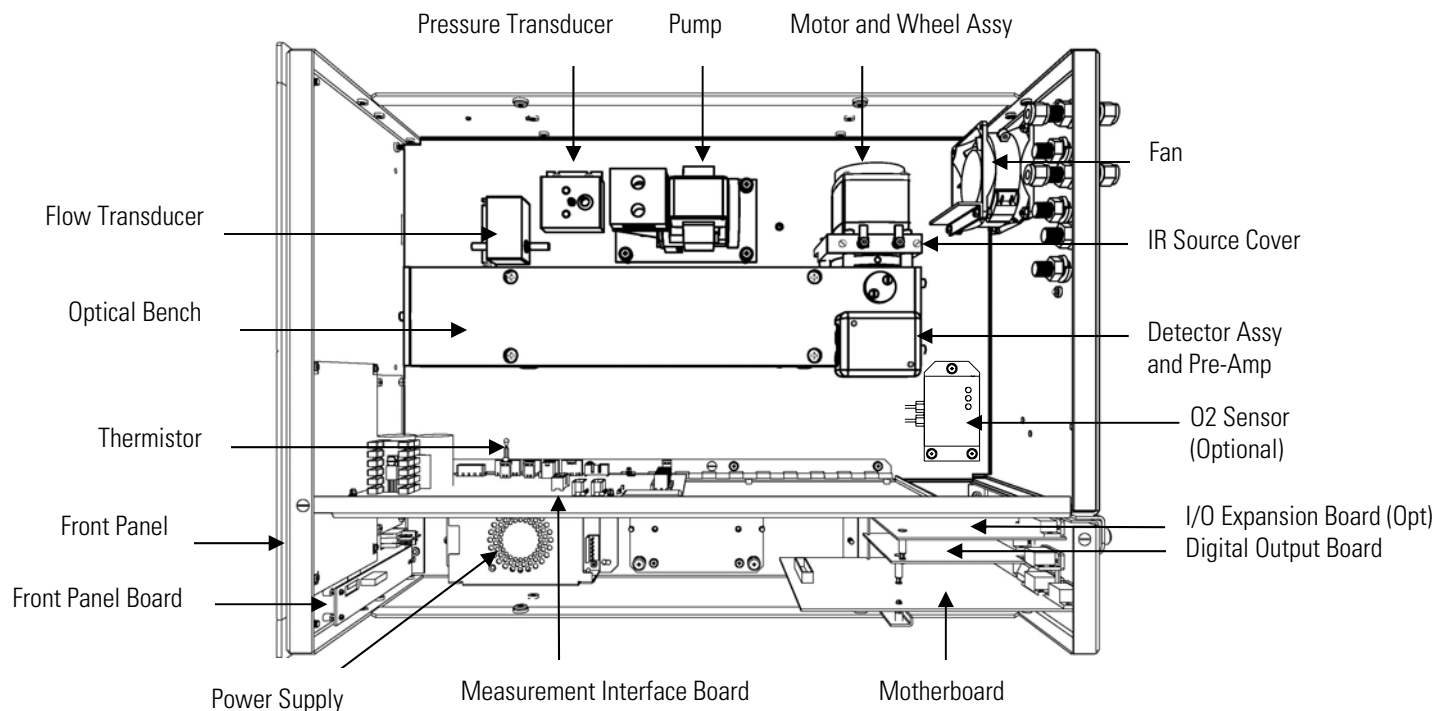

Figure 8–1. Hardware Components

Optical Bench

The optical bench is an airtight chamber that contains the sample gas. The bench includes mirrors that cause the infrared light from the infrared source to pass through the sample gas multiple times before reaching the infrared detector.

Band-pass Filter

The band-pass filter limits the light entering the optical bench to a narrow band of the infrared portion of the spectrum.

Bench Heater Board

The bench heater board applies power to the bench heater resistors and transmits the bench temperature monitored by a thermistor. This assembly is used for maintaining the optical bench at a constant temperature.

Chopper Motor

The chopper motor spins the gas filter wheel and chopper disk at a uniform speed.

Optical Pickup The optical pickup detects the position of the gas filter wheel, provides synchronizing signals for the signal demodulation, and provides a method for checking the chopper motor speed.

Gas Filter Wheel The gas filter wheel contains samples of CO and N₂ gas that filter the radiation from the infrared source. A chopper disk that rotates along with the wheel periodically interrupts the radiation to create a modulated signal.

Infrared Source The infrared source is a special wire-wound resistor operated at high temperature to create infrared radiation.

Pre-amplifier Assembly with IR Detector The pre-amplifier assembly is mounted on the optical bench along with an infrared detector that detects the energy of the infrared light passing through the optical bench. It amplifies the pulsating signal from the infrared detector.

Sample Flow Sensor The sample flow sensor, located at the optical bench outlet, measures the flow of sample through the optical bench.

Pressure Transducer The pressure transducer measures the pressure of the sample gas.

Capillary The capillary and the pump control the sample gas flow.

Pump The pump draws the sample gas through the optical filter bench.

Purge Flow Switch (optional) The purge flow switch monitors the flow of purge gas when the filter wheel purge gas option is installed.

Firmware The processor firmware tasks are organized into four areas:

- Instrument control
- Monitoring signals
- Measurement calculations
- Output communication

Instrument Control

Low-level embedded processors are used to control the various functions on the boards, such as analog and digital I/O. These processors are controlled over a serial interface with a single high-level processor that also controls the front-panel user interface. The low-level processors all run a common piece of firmware that is bundled with the high-level firmware and loaded on power-up if a different version is detected.

Each board has a specific address that is used to identify to the firmware what functions are supported on that board. This address is also used for the communications between the low-level processors and the high-level processor.

Every tenth of a second, the frequency counters, analog I/O, and digital I/O are read and written to by the low-level processors. The counters are accumulated over the past second and the analog inputs are averaged over that second. The high-level processor polls the low-level processors once per second to exchange the measurement and control data.

Monitoring Signals

Signals are gathered from the low-level processors once per second, and then processed by the high-level processor to produce the final measurement values. The one-second accumulated counts are accumulated and reported for the user-specified averaging time. If this averaging time is greater than ten seconds, the measurement is still reported every 10 seconds. The one-second average of the other analog inputs are reported directly (no additional signal conditioning is performed by the high-level processor).

Output Communication

The front panel display, serial and Ethernet data ports, and analog outputs are the means of communicating the results of the above calculations. The front panel display presents the concentrations simultaneously. The display is updated every 1-10 seconds, depending on the averaging time.

The analog output ranges are user selectable via the firmware. The analog outputs are defaulted based on the measurement range. The defaults are calculated by dividing the data values by the full-scale range for each of the three parameters and then multiplying each result by the user-selected output range. Negative concentrations can be represented as long as they are within -5% of full-scale. The zero and span values may be set by the user to any desired value.

Electronics

All electronics operate from a universal switching supply, which is capable of auto-sensing the input voltage and working over all specified operating ranges.

Internal pumps and heaters all operate on 110VAC. An optional transformer is required if operating on the 210-250VAC or 90-110VAC ranges.

An on/off switch controls all power to the instrument, and is accessible on the front panel.

Motherboard

The motherboard contains the main processor, power supplies, and a sub-processor, and serves as the communication hub for the instrument. The motherboard receives operator inputs from the front panel function keys and/or over I/O connections on the rear panel. The motherboard sends commands to the other boards to control the functions of the instrument and to collect measurement and diagnostic information. The motherboard outputs instrument status and measurement data to the graphics display and to the rear-panel I/O. The motherboard also contains I/O circuitry and the associated connector to monitor external digital status lines and to output analog voltages that represent the measurement data. Connectors located on the motherboard include:

External connectors:

- External Accessory
- RS-232/485 Communications (two connectors)
- Ethernet Communications
- I/O connector with Power Fail Relay, 16 Digital Inputs, and 6 Analog Voltage Outputs.

Internal connectors:

- Function Key Panel and Display
- Measurement Interface Board
- I/O Expansion Board
- Digital Output Board
- AC Distribution

Measurement Interface Board

The measurement interface board serves as a central connection area for all measurement electronics in the instrument. It contains power supplies and interface circuitry for sensors and control devices in the measurement system. It sends status data to the motherboard and receives control signals from the motherboard.

Measurement Interface Board Connectors

Connectors located on the measurement interface board include:

- Data communication with the motherboard
- 24V and 120VAC power supply inputs
- Fan and solenoid outputs
- 120VAC output and thermistor input from the bench heater board
- Flow and pressure sensor inputs
- Chopper motor output
- Optical pickup input
- Pre-amp board
- Ambient temperature thermistor
- Purge flow switch input

Flow Sensor Assembly

The flow sensor assembly consists of a board containing an instrumentation amplifier and a flow transducer with input and output gas fittings. The flow transducer output is produced by measuring the pressure difference across a precision orifice. This unit is used for measuring the flow of sample gas in the measurement system.

Pressure Sensor Assembly

The pressure sensor assembly consists of a board containing an instrumentation amplifier and a pressure transducer with a gas input fitting. The pressure transducer output is produced by measuring the pressure difference between the sample gas pressure and ambient air pressure.

Bench Heater Board

The bench heater board provides connections for the optical bench heater resistors and optical bench temperature thermistor.

The optical bench temperature is measured with a thermistor. The voltage across the thermistor is applied to the main processor and used to display and control the temperature of the optical bench. The main processor compares the voltage to a set point and controls the 120VAC power to the bench heater resistors to maintain a constant bench temperature.

Pre-amp Board Assembly

The pre-amp board assembly amplifies the signal from an infrared sensor that receives light passing through the sample gas. The preamplifier gain is adjusted by the main processor to bring the signal amplitude within a normal operating range. The output of the pre-amp board is fed to the measurement interface board. Wires from the pre-amp board apply power to the infrared source resistor. The pre-amp board assembly is mounted on top of the optical bench.

Digital Output Board

The digital output board connects to the motherboard and provides solenoid driver outputs and relay contact outputs to a connector located on the rear panel of the instrument. Ten relay contacts, normally open (with power off), are provided, which are electrically isolated from each other. Eight solenoid driver outputs (open collector) are provided along with a corresponding +24VDC supply pin on the connector.

I/O Expansion Board (Optional)

The I/O expansion board connects to the motherboard and adds the capability to input external analog voltage signals and to output analog currents via a connector located on the rear panel of the instrument. It contains local power supplies, a DC/DC isolator supply, a sub-processor and analog circuits. Eight analog voltage inputs are provided with an input voltage range of 0V to 10VDC. Six current outputs are provided with a normal operating range of 0 to 20 mA.

Front Panel Connector Board

The front panel connector board interfaces between the motherboard and the function key panel and graphics display. It serves as central location to tie the three connectors required for the function key panel, the graphics display control lines, and the graphics display backlight to a single ribbon cable extending back to the motherboard. This board also includes signal buffers for the graphics display control signals and a high voltage power supply for the graphics display backlight.

I/O Components

External I/O is driven from a generic bus that is capable of controlling the following devices:

- Analog output (voltage and current)
- Analog input (voltage)
- Digital output (TTL levels)
- Digital input (TTL levels)

Note The instrument has spare solenoid valve drivers and I/O support for future expansion. ▲

Analog Voltage Outputs

The instrument provides six analog voltage outputs. Each may be firmware configured for any one of the following ranges, while maintaining a minimum resolution of 12 bits:

- 0-100mV
- 0-1V
- 0-5V
- 0-10V

The user can calibrate each analog output zero and span point through the firmware. At least 5% of full-scale over and under range are also supported, but may be overridden in the firmware, if required.

The analog outputs may be assigned to any measurement or diagnostic channel with a user-defined range in the units of the selected parameter. The voltage outputs are independent of the current outputs.

Analog Current Outputs (Optional)

The optional I/O expansion board includes six isolated current outputs. These are firmware configured for any one of the following ranges, while maintaining a minimum resolution of 11 bits:

- 0-20 mA
- 4-20 mA

The user can calibrate each analog output zero and span point through firmware. At least 5% of full-scale over and under range are also supported, but may be overridden in the firmware, if required.

The analog outputs may be assigned to any measurement or diagnostic channel with a user-defined range in the units of the selected parameter. The current outputs are independent of the voltage outputs. The current outputs are isolated from the instrument power and ground, but they share a common return line (Isolated GND).

Analog Voltage Inputs (Optional)

Eight analog voltage inputs are used to gather measurement data from third-party devices. The user may assign a label, unit, and a conversion table (2 to 10 points). Each point in the conversion table consists of an analog input voltage value (0-10.5 V) and a corresponding user-defined reading value. Only two points are necessary for linear inputs, however a larger number of points may be used to approximate non-linear inputs. All voltage inputs have a resolution of 12 bits over the range of 0 to 10.5 volts.

Digital Relay Outputs

The instrument includes one power fail relay on the motherboard and ten digital output relays on the digital output board. These are reed relays rated for at least 500 mA @ 200VDC.

The power fail relay is Form C (both normally opened and normally closed contacts). All other relays are Form A (normally opened contacts) and are used to provide alarm status and mode information from the analyzer, as well as remote control to other devices, such as for controlling valves during calibration. The user may select what information is sent out from each relay and whether the active state is opened or closed.

Digital Inputs

Sixteen digital inputs are available, which may be programmed to signal instrument modes and special conditions including:

- Zero Gas Mode
- Span Gas Mode
- Set Background
- Calibrate to low range span concentration
- Calibrate to high range span concentration
- Analog outputs to zero
- Analog outputs to full-scale
- External Alarms

The actual use of these inputs will vary based on analyzer configuration.

The digital inputs are TTL level compatible and are pulled up within the analyzer. The active state can be user defined in firmware.

Serial Ports

Two serial ports allow daisy chaining so that multiple analyzers may be linked using one PC serial port.

The standard bi-directional serial interface can be configured for either RS-232 or RS-485. The serial baud rate is user selectable in firmware for standard speeds from 1200 to 115200 baud. The user can also set the data bits, parity, and stop bits. The following protocols are supported:

- C-Link
- MODBUS Slave
- Gesytec (Bayern-Hessen)
- Streaming Data

The Streaming Data protocol transmits user-selected measurement data via the serial port in real-time for capture by a serial printer, data logger, or PC.

RS-232 Connection

A null modem (crossed) cable is required when connecting the analyzer to an IBM-compatible PC. However, a straight cable (one to one) may be required when connecting the analyzer to other remote devices. As a general rule, when the connector of the host remote device is female, a straight cable is required and when the connector is male, a null modem cable is required.

Data Format:

1200, 2400, 4800, 9600, 19200, 38400, 57600, or 115200 BAUD

7 or 8 data bits

1 or 2 stop bits

No, odd, or even parity

All responses are terminated with a carriage return (hex 0D)

Refer to [Table 8–1](#) for the DB9 connector pin configuration.

Table 8–1. RS-232 DB9 Connector Pin Configuration

DB9 Pin	Function
2	RX
3	TX
7	RTS
8	CTS
5	Ground

RS-485 Connection

The instrument uses a four wire RS-485 configuration with automatic flow control (SD). Refer to [Table 8–2](#) for the DB9 connector pin configuration.

Table 8–2. RS-485 DB9 Connector Pin Configuration

DB9 Pin	Function
2	+ receive
8	- receive
7	+ transmit
3	- transmit
5	ground

Ethernet Connection

An RJ45 connector is used for the 10Mbps Ethernet connection supporting TCP/IP communications via standard IPV4 addressing. The IP address may be configured for static addressing or dynamic addressing (set using a DHCP server).

Any serial port protocols may be accessed over Ethernet in addition to the serial port. Up to three simultaneous connections are allowed per protocol.

External Accessory Connector

The external accessory connector is not used in the Model 48*i* analyzer.

This port is used in other models to communicate with smart external devices that may be mounted hundreds of feet from the analyzer using an RS-485 electrical interface.

Chapter 9

Optional Equipment

The Model 48*i* is available with the following options:

- “Internal Zero/Span Assembly” on page 9-1
- “Internal Oxygen (O₂) Sensor” on page 9-1
- “Internal Zero Air Scrubber” on page 9-4
- “Filter Wheel Purge” on page 9-4
- “Teflon Particulate Filter” on page 9-5
- “I/O Expansion Board Assembly” on page 9-5
- “Terminal Block and Cable Kits” on page 9-5
- “Cables” on page 9-6
- “Mounting Options” on page 9-7

Internal Zero/Span Assembly

With the internal zero/span assembly option, a source of span gas is connected to the SPAN port and a source of zero air is connected to the ZERO port. Zero and span gas should be supplied at atmospheric pressure. It may be necessary to use an atmospheric dump bypass plumbing arrangement to accomplish this.

For more information, refer to the “[Installation](#)” chapter and the “[Operation](#)” chapter.

Internal Oxygen (O₂) Sensor

The Internal Oxygen (O₂) Sensor option provides a paramagnetic sensor for O₂ concentration measurement and CO correction. This option allows the user to correct the CO readings for the amount of oxygen in the sample. Selectable O₂ concentrations can be used as the correction factor.

[Figure 9–1](#) shows how this option is integrated with the Model 48*i* with and without the zero/span option.

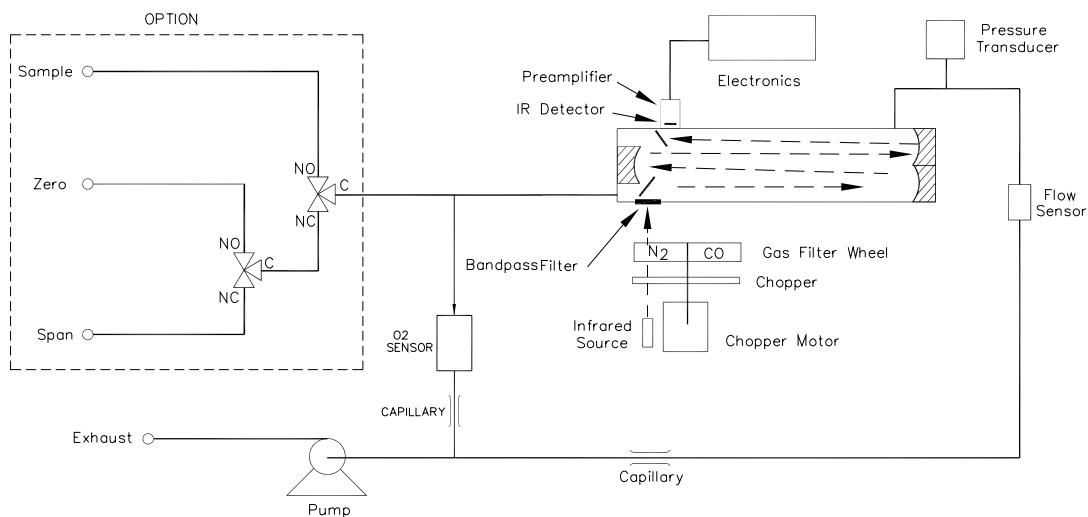

Figure 9-1. Flow Diagram, Internal O₂ Sensor

Internal O₂ Sensor Calibration

This section describes how to calibrate the optional internal O₂ sensor.

Be sure to power the analyzer for half an hour at normal operating conditions (with the cover on) before calibration. The internal O₂ sensor should be calibrated at the zero and span points, as described in the following procedure.



Note The total airflow of the calibration gases must exceed the total demand of the analyzer. The Model 48*i* requires approximately 1000 cc/min of sample flow, so a total airflow of at least 1100 cc/min is recommended. ▲

Use the following procedure to calibrate the oxygen sensor under normal conditions. If you are unable to calibrate the oxygen sensor effectively using the following procedure, use the Alternate Calibration Procedure.

Calibration Equipment:

Test gas: Nitrogen zero gas - span gas approximately 20% oxygen concentration.



1. Supply the nitrogen zero gas to the SAMPLE port on the rear of the analyzer and wait for the O₂ reading to stabilize.

2. From the Main Menu choose Calibration > **Calibrate O₂ Background** and press  to set the O₂ background to zero.
3. Supply the O₂ Span gas to the SAMPLE port on the rear of the analyzer and wait for the O₂ reading to stabilize.
4. From the Main Menu choose Calibration > **Calibrate O₂ Coefficient**, enter the span concentration, and press  to set the O₂ coefficient.

Note If you were unable to calibrate the oxygen sensor effectively using this procedure, recalibrate using the “Alternate Sensor Calibration” procedure that follows. ▲

Alternate Sensor Calibration

Use the following procedure if the standard calibration procedure described previously fails to calibrate properly or for high altitude (5000m/15400 ft) calibration.

1. Supply the nitrogen zero gas to the SAMPLE port on the rear of the analyzer.
2. From the Main Menu choose Calibration Factors > **O₂ Background**, set the O₂ background to zero, and press  to set the O₂ background.
3. Use the screwdriver to adjust zero potentiometer RV1 such that the O₂ value reads 0.00% O₂.
4. Use the screwdriver to adjust the span potentiometer RV2 fully clockwise.
5. Supply the O₂ span gas to the SAMPLE port on the rear of the analyzer.
6. From the Main Menu choose Calibration Factors > **O₂ Coefficient**, set the O₂ coefficient to 1.000, and press  to set the O₂ coefficient.
7. Use the screwdriver to adjust the coarse span potentiometer RV3 such that the O₂ reading is 20% greater than the calibration gas value. For example, 25% O₂ span gas should be set to produce an output of 30.00% O₂.

8. Use the screwdriver to adjust the Span potentiometer RV2 such that the O₂ reading indicates the correct percent concentration. For example, 25% oxygen span gas should be set to produce a measurement of 25.00%.
9. Replace the cover, wait 30 minutes for the instrument to stabilize, and repeat the four steps in the “Calibration” procedure.

Internal Zero Air Scrubber

The internal air scrubber is mounted inside the instrument and provides a source of zero air.

Filter Wheel Purge

The filter wheel purge option includes a housing attached between the optical bench and the motor plate ([Error! Reference source not found.](#)). It surrounds the gas correlation wheel and allows purging the area around the gas correlation wheel with a gas other than that present in the local atmosphere. This option increases reliability in the presence of contaminants that could interfere with the analytical process.

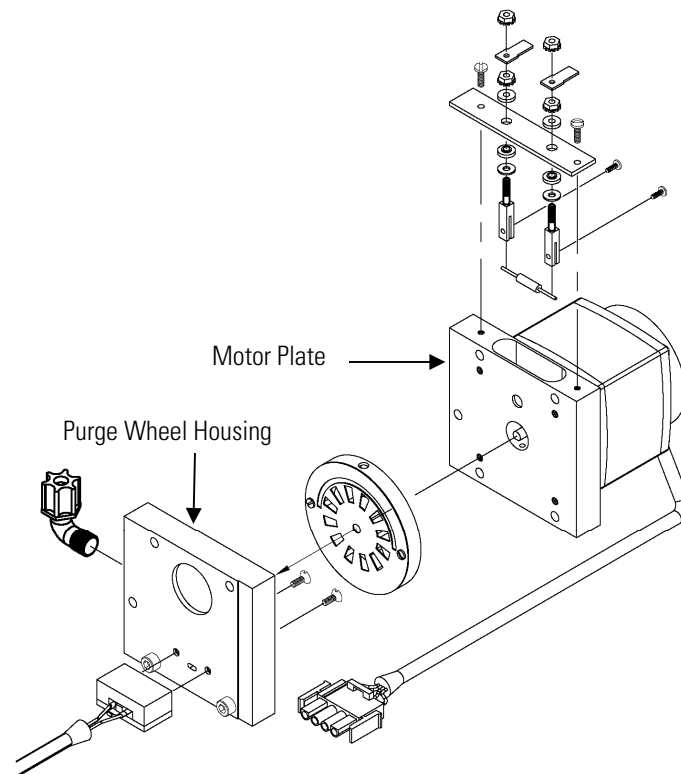

Figure 9–2. Purge Housing Assembly

Calibration Note

The stability of the purge gas is very important. Since this gas is in the same optical path as the sample, changes in the composition of the purge gas can change the calibration of the instrument. Therefore, either zero air or a non-toxic dry inert gas, such as nitrogen, is recommended for use in this option. Other than the effect of the purge gas, operation and calibration of the instrument is not affected by the addition of the purge housing.

A constant purge flow of approximately 140cc/min is recommended for optimum performance. This is produced by feeding a purge gas to the rear panel bulkhead at a constant pressure of 15 psig. A 0.006-inch glass capillary (green) will deliver the required 140cc/min purge flow. Flows greater than this are not recommended due to unstable cooling effects on the IR source. Lower flows are acceptable as long as the purge housing is adequately purged for the application.

Teflon Particulate Filter

A 5-10 micron pore size, two-inch diameter Teflon® element is available for the Model 48*i*. This filter should be installed just prior to the SAMPLE bulkhead. When using a filter, all calibrations and span checks must be performed through the filter.

I/O Expansion Board Assembly

The I/O expansion board provides six analog current output channels (0-20 mA or 4-20 mA) and eight analog voltage inputs (0-10V). The DB25 connector on the rear panel provides the interface for these inputs and outputs.

25-Pin Terminal Board Assembly

The 25-pin terminal board assembly is included with the optional I/O expansion board. Refer to “Terminal Board PCB Assemblies” on page 2-5 for information on attaching the cable to the connector board. For associated part numbers, refer to “[External Device Connection Components](#)” on page 7-6.

Terminal Block and Cable Kits

The optional terminal block and cable kits provide a convenient way to connect devices to the instrument. These kits break out the signals on the rear panel connector to individual numbered terminals.

Two types of terminal block and cable kits are available. One kit is for the DB37 connectors and can be used for either the analog output connector or the relay output connector. The other kit is for the DB25 connector and can be used for the optional I/O expansion board. For associated part numbers, refer to “[External Device Connection Components](#)” on page 7-6.

Each kit consists of:

- one six-foot cable
- one terminal block
- one snap track

Note Supporting all of the connections on units with the optional I/O expansion board requires:

- two DB37 kits
- one DB25 kit

Cables

Table 9–1 identifies the optional individual cables that are available for the instrument and Table 9–2 provides the cable color codes. For associated part numbers, refer to “External Device Connection Components” on page 7-6.

Note Table 9–2 provides the color coding for both 25-pin cables and 37-pin cables. Color codes for pins 1-25 are for 25-pin cables; color codes for pins 1-37 are for 37-pin cables. ▲

Table 9–1. Cable Options

Description	Cable Length
DB37M to open end	Six feet
DB37F to open end	Six feet
DB25M to open end	Six feet
RS-232	Six feet

Table 9–2. Color Codes for 25-Pin and 37-Pin Cables

Pin	Color	Pin	Color
1	BLACK	20	RED/BLACK
2	BROWN	21	ORANGE/BLACK
3	RED	22	YELLOW/BLACK
4	ORANGE	23	GREEN/BLACK
5	YELLOW	24	GRAY/BLACK
6	GREEN	25	PINK/BLACK
7	BLUE	End color codes for 25-pin cables continue for 37-pin cables.	

Pin	Color	Pin	Color
8	VIOLET	26	PINK/GREEN
9	GRAY	27	PINK/RED
19	WHITE	28	PINK/VIOLET
11	PINK	29	LIGHT BLUE
12	LIGHT GREEN	30	LIGHT BLUE/BROWN
13	BLACK/WHITE	31	LIGHT BLUE/RED
14	BROWN/WHITE	32	LIGHT BLUE/VIOLET
15	RED/WHITE	33	LIGHT BLUE/BLACK
16	ORANGE/WHITE	34	GRAY/GREEN
17	GREEN/WHITE	35	GRAY/RED
18	BLUE/WHITE	36	GRAY/VIOLET
19	VIOLET/WHITE	37	LIGHT GREEN/BLACK

Mounting Options

The analyzer can be installed in the configuration described in [Table 9–3](#) and shown in [Figure 9–3](#) through [Figure 9–6](#).

Table 9–3. Mounting Options

Mounting Type	Description
Bench	Positioned on bench, includes mounting feet, and front panel side-trim handles.
EIA rack	Mounted in an EIA-style rack, includes mounting slides, and front panel EIA-rack mounting handles.
Retrofit rack	Mounted in an EIA-style rack, includes mounting slides and front panel EIA-rack mounting handles. This configuration is intended for direct replacement of a C-series instrument in an existing rack. The rail mounting location is lower on the case and the front mounting screw slots are in non-standard EIA locations.

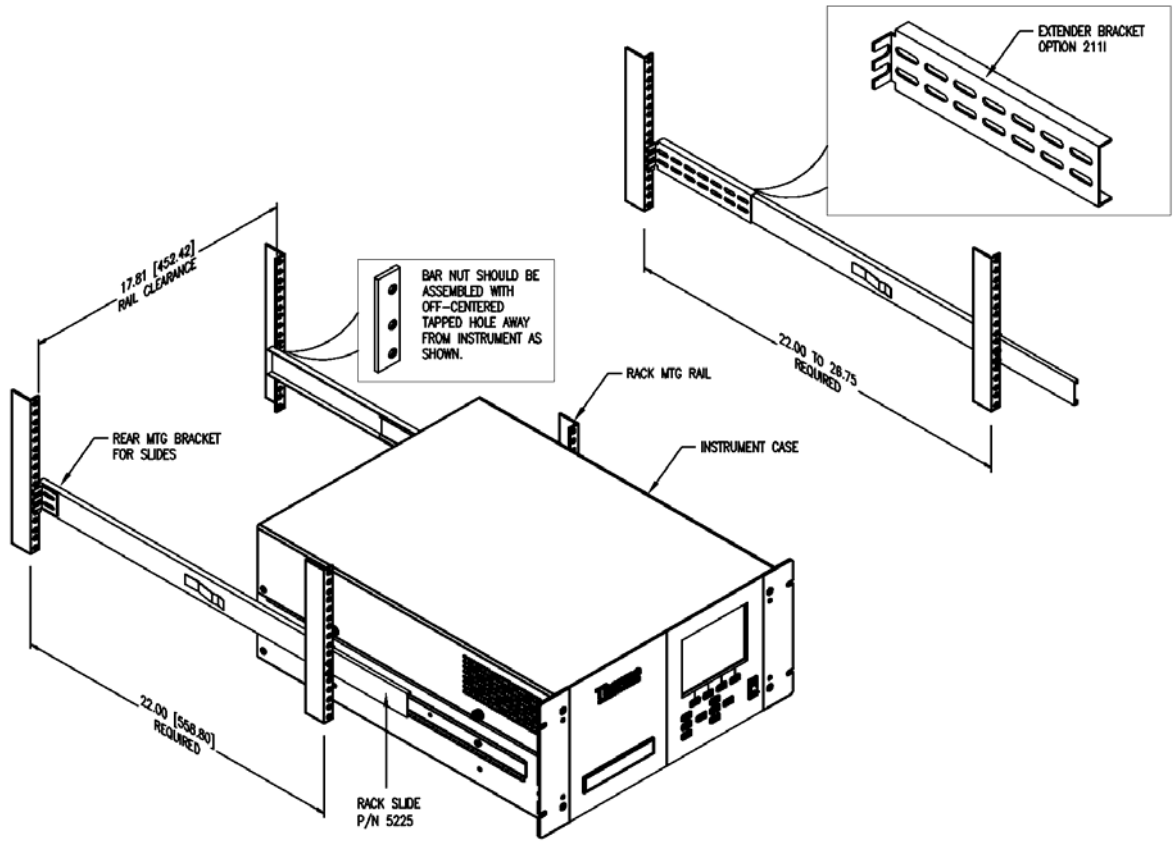

Figure 9-3. Rack Mount Option Assembly

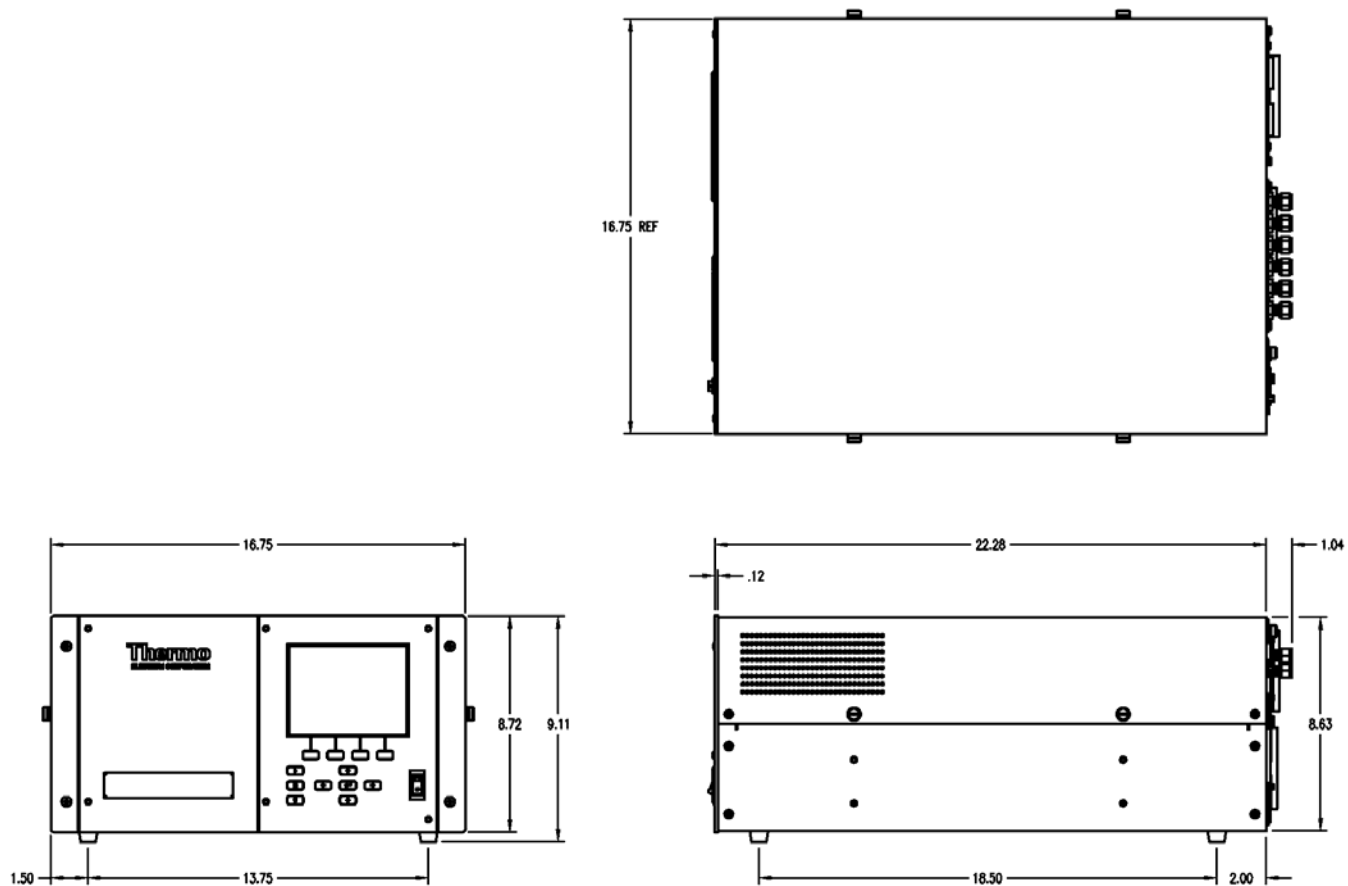

Figure 9-4. Bench Mounting

Optional Equipment
Mounting Options

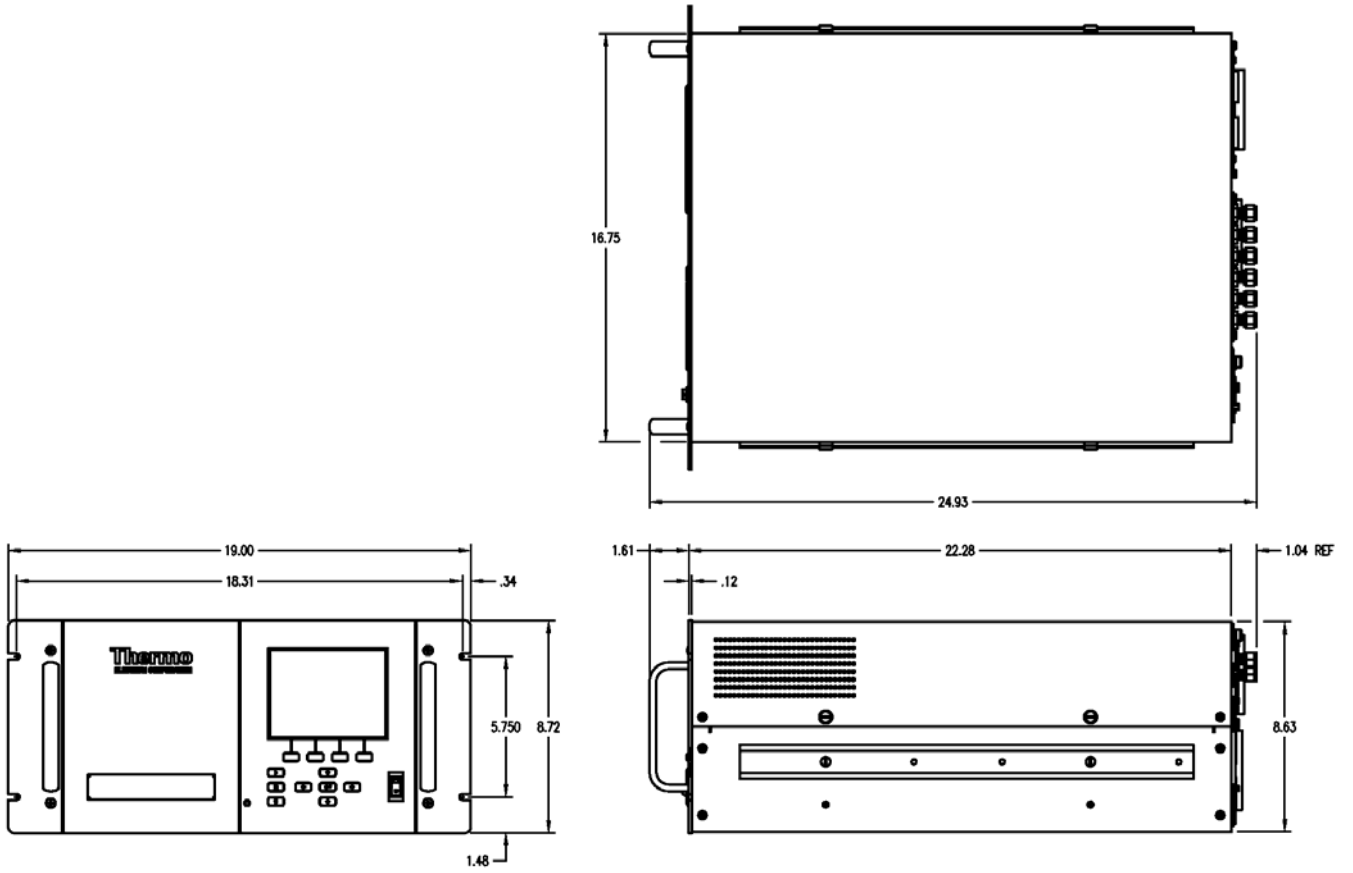

Figure 9-5. EIA Rack Mounting

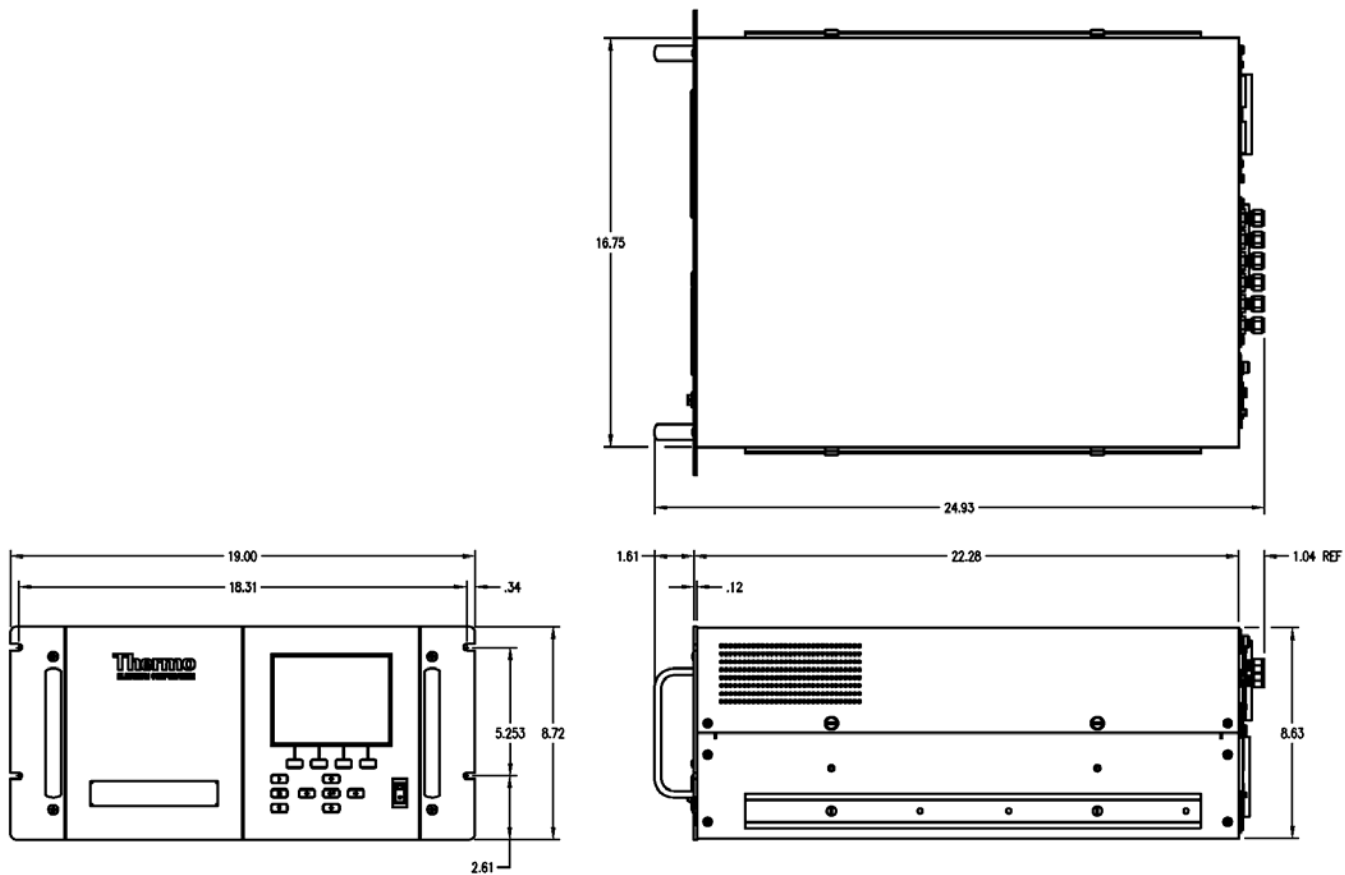

Figure 9-6. Retrofit Rack Mounting

Appendix A

Warranty

Seller warrants that the Products will operate or perform substantially in conformance with Seller's published specifications and be free from defects in material and workmanship, when subjected to normal, proper and intended usage by properly trained personnel, for the period of time set forth in the product documentation, published specifications or package inserts. If a period of time is not specified in Seller's product documentation, published specifications or package inserts, the warranty period shall be one (1) year from the date of shipment to Buyer for equipment and ninety (90) days for all other products (the "Warranty Period"). Seller agrees during the Warranty Period, to repair or replace, at Seller's option, defective Products so as to cause the same to operate in substantial conformance with said published specifications; provided that (a) Buyer shall promptly notify Seller in writing upon the discovery of any defect, which notice shall include the product model and serial number (if applicable) and details of the warranty claim; (b) after Seller's review, Seller will provide Buyer with service data and/or a Return Material Authorization ("RMA"), which may include biohazard decontamination procedures and other product-specific handling instructions; and (c) then, if applicable, Buyer may return the defective Products to Seller with all costs prepaid by Buyer. Replacement parts may be new or refurbished, at the election of Seller. All replaced parts shall become the property of Seller. Shipment to Buyer of repaired or replacement Products shall be made in accordance with the Delivery provisions of the Seller's Terms and Conditions of Sale. Consumables, including but not limited to lamps, fuses, batteries, bulbs and other such expendable items, are expressly excluded from the warranty under this warranty.

Notwithstanding the foregoing, Products supplied by Seller that are obtained by Seller from an original manufacturer or third party supplier are not warranted by Seller, but Seller agrees to assign to Buyer any warranty rights in such Product that Seller may have from the original manufacturer or third party supplier, to the extent such assignment is allowed by such original manufacturer or third party supplier.

In no event shall Seller have any obligation to make repairs, replacements or corrections required, in whole or in part, as the result of (i) normal wear and tear, (ii) accident, disaster or event of force majeure, (iii) misuse, fault or negligence of or by Buyer, (iv) use of the Products in a manner for which

they were not designed, (v) causes external to the Products such as, but not limited to, power failure or electrical power surges, (vi) improper storage and handling of the Products or (vii) use of the Products in combination with equipment or software not supplied by Seller. If Seller determines that Products for which Buyer has requested warranty services are not covered by the warranty hereunder, Buyer shall pay or reimburse Seller for all costs of investigating and responding to such request at Seller's then prevailing time and materials rates. If Seller provides repair services or replacement parts that are not covered by the warranty provided in this warranty, Buyer shall pay Seller therefor at Seller's then prevailing time and materials rates. ANY INSTALLATION, MAINTENANCE, REPAIR, SERVICE, RELOCATION OR ALTERATION TO OR OF, OR OTHER TAMPERING WITH, THE PRODUCTS PERFORMED BY ANY PERSON OR ENTITY OTHER THAN SELLER WITHOUT SELLER'S PRIOR WRITTEN APPROVAL, OR ANY USE OF REPLACEMENT PARTS NOT SUPPLIED BY SELLER, SHALL IMMEDIATELY VOID AND CANCEL ALL WARRANTIES WITH RESPECT TO THE AFFECTED PRODUCTS.

THE OBLIGATIONS CREATED BY THIS WARRANTY STATEMENT TO REPAIR OR REPLACE A DEFECTIVE PRODUCT SHALL BE THE SOLE REMEDY OF BUYER IN THE EVENT OF A DEFECTIVE PRODUCT. EXCEPT AS EXPRESSLY PROVIDED IN THIS WARRANTY STATEMENT, SELLER DISCLAIMS ALL OTHER WARRANTIES, WHETHER EXPRESS OR IMPLIED, ORAL OR WRITTEN, WITH RESPECT TO THE PRODUCTS, INCLUDING WITHOUT LIMITATION ALL IMPLIED WARRANTIES OF MERCHANTABILITY OR FITNESS FOR ANY PARTICULAR PURPOSE. SELLER DOES NOT WARRANT THAT THE PRODUCTS ARE ERROR-FREE OR WILL ACCOMPLISH ANY PARTICULAR RESULT.

Appendix B

C-Link Protocol Commands

This appendix provides a description of the C-Link protocol commands that can be used to remotely control a Model 48*i* analyzer using a host device such as a PC or a datalogger. C-Link protocol may be used over RS-232, RS-485, or Ethernet. C-Link functions can be accessed over Ethernet using TCP port 9880.

Streaming data is sent out the serial port or the Ethernet port on a user-defined periodic basis. Streaming data over Ethernet is only generated when a connection is made on TCP port 9881.

Up to three simultaneous connections per protocol may be made over Ethernet.

For details, see the following topics:

- “[Instrument Identification Number](#)” on page B-1
- “[Commands](#)” on page B-2
- “[Measurements](#)” on page B-10
- “[Alarms](#)” on page B-14
- “[Diagnostics](#)” on page B-18
- “[Datalogging](#)” on page B-19
- “[Calibration](#)” on page B-26
- “[Keys/Display](#)” on page B-33
- “[Measurement Configuration](#)” on page B-35
- “[Hardware Configuration](#)” on page B-38
- “[Communications Configuration](#)” on page B-40
- “[I/O Configuration](#)” on page B-47
- “[Record Layout Definition](#)” on page B-53

Instrument Identification Number

Each command sent to the analyzer over the serial port must begin with the American Standard Code for Information Interchange (ASCII) symbol or byte value equivalent to the instrument's identification number plus 128.

For example, if the instrument ID is set to 48, then each command must begin with the ASCII character code 176 decimal. The analyzer ignores any command that does not begin with its instrument identification number. If the instrument ID is set to 0, then this byte is not required. For more information on changing Instrument ID, see Chapter 3, “Operation”.

Commands

The analyzer must be in the remote mode in order to change instrument parameters via remote. However, the command “set mode remote” can be sent to the analyzer to put it in the remote mode. Report commands (commands that don’t begin with “set”) can be issued either in the remote or local mode. For information on changing modes, see Chapter 3, “Operation”.

The commands can be sent in either uppercase or lowercase characters. Each command must begin with the proper instrument identification number (ASCII) character. The command in the following example begins with the ASCII character code 176 decimal, which directs the command to the Model 48*i*, and is terminated by a carriage return “CR” (ASCII character code 13 decimal).

<ASCII 176>	T	I	M	E	<CR>
-------------	---	---	---	---	------

Many of the commands have two forms. One form reads parameter from the instrument’s memory, and the other writes, or updates, a parameter. The syntax for a write command adds the word “set” in front of the command and provides an argument. Command responses are generally echoed with a data element appended.

Note If the Service Mode is active, C-Link “set” commands are not allowed. This is to prevent parameters from being changed remotely while the unit is being serviced locally. ▲

If an incorrect command is sent, an error message is generated. The list of error responses is shown in Table B–1. The following example sends the incorrect command “set unit ppm” instead of the correct command “set gas unit ppm.”

```
Send:          set unit ppm
Receive:       set unit ppm bad cmd
```

Table B–1. Command Response Error Descriptions

Command Response	Description
bad cmd	Command is not recognized
too high	Supplied value is higher than the upper limit
too low	Supplied value is lower than the lower limit
invalid string	Supplied string invalid (typically because a letter was detected when the value should be numeric)
data not valid	Supplied value is not acceptable for entered command
can't, wrong settings	Command not allowed for current measurement mode
can't, mode is service	Command not allowed while instrument is in service mode

The “save” and “set save params” commands (duplicated for backward compatibility) store parameters in FLASH memory. It is important that this command be sent each time instrument parameters are changed. If changes are not saved, they will be lost in the event of a power failure.

Entering Units in PPB

When interfacing to an instrument via C-link commands, always enter the concentration values in ppb or $\mu\text{g}/\text{m}^3$ units. For example, to set a background value to 20 ppm, enter 20000 (ppb) as the value for the set background command.

Convert Concentration Formats

Convert concentration formats from $\text{xxxxE}+\text{yy}$ to $\text{x.xxxE}+\text{yy}$. The *i*Series uses more standard script than the C-Series by placing only one digit to the left of the decimal.

Commands List

Table B–2 lists the 48*i* C-Link protocol commands. The interface will respond to the command strings outlined below.

Table B–2. C-Link Protocol Commands

Command	Description	Page
1	Simulates pressing soft key 1 pushbutton	B-33
2	Simulates pressing soft key 2 pushbutton	B-33
3	Simulates pressing soft key 3 pushbutton	B-33
4	Simulates pressing soft key 4 pushbutton	B-33
addr dns	Reports/sets domain name server address for Ethernet port	B-40
addr gw	Reports/sets default gateway address for Ethernet port	B-41
addr ip	Reports/sets IP address for Ethernet port	B-41

C-Link Protocol Commands

Commands

Command	Description	Page
addr nm	Reports/sets netmask address for Ethernet port	B-41
addr ntp	Reports/sets IP address for network time protocol server	B-42
agc int	Reports current AGC intensity	B-18
alarm agc intensity max	Reports/sets AGC intensity alarm maximum value	B-14
alarm agc intensity min	Reports/sets AGC intensity alarm minimum value	B-14
alarm bias voltage max	Reports/sets bias voltage alarm maximum value	B-14
alarm bias voltage min	Reports/sets bias voltage alarm minimum value	B-14
alarm chamber temp max	Reports/sets bench temperature alarm maximum value	B-14
alarm chamber temp min	Reports/sets bench temperature alarm minimum value	B-14
alarm conc max	Reports/sets current CO concentration alarm maximum value	B-15
alarm conc min	Reports/sets current CO concentration alarm minimum value	B-15
alarm conc o2 max	Reports/sets current oxygen concentration alarm maximum value	B-15
alarm conc o2 min	Reports/sets current oxygen concentration alarm minimum value	B-15
alarm internal temp max	Reports/sets internal temperature alarm maximum value	B-16
alarm internal temp min	Reports/sets internal temperature alarm minimum value	B-16
alarm motor speed max	Reports/sets motor speed alarm maximum value	B-16
alarm motor speed min	Reports/sets motor speed alarm minimum value	B-16
alarm pressure max	Reports/sets pressure alarm maximum value	B-16
alarm pressure min	Reports/sets pressure alarm minimum value	B-16
alarm sample flow max	Reports/sets sample flow alarm maximum value	B-17
alarm sample flow min	Reports/sets sample flow alarm minimum value	B-17
alarm trig conc	Reports/sets current CO concentration alarm trigger sense	B-17
alarm trig conc o2	Reports/sets current O ₂ concentration alarm warning value	B-18

Command	Description	Page
allow mode cmd	Reports/sets whether "set mode" locks instrument front panel	B-45
analog iout range	Reports/sets analog current output range per channel	B-48
analog vin	Retrieves analog voltage input data per channel	B-48
analog vout range	Reports/sets analog voltage output range per channel	B-49
avg time	Reports/sets averaging time	B-10
baud	Reports/sets current baud rate	B-42
bias voltage	Reports current IR bias supply voltage	B-18
bkg o2	Reports/sets current O ₂ background	B-29
cal bkg o2	Sets/auto-calibrates O ₂ background	B-27
cal co bkg	Sets/auto-calibrates CO background	B-26
cal co coef	Sets/auto-calibrates CO coefficient	B-27
cal coef o2	Sets/auto-calibrates O ₂ coefficient	B-27
cal high co coef	Sets/auto-calibrates high range CO coefficient	B-27
cal low co coef	Sets/auto-calibrates low range CO coefficient	B-27
calibrate	Sets CO coefficient	B-27
chamber temp	Reports optical bench temperature	B-12
clr lrecs	Clears away only lrecs that have been saved	B-19
clr records	Clears away all logging records that have been saved	B-19
clr srecs	Clears away only srecs that have been saved	B-19
co	Reports current CO concentration	B-11
co bkg	Reports/sets current CO background	B-29
co coef	Reports/sets current CO coefficient	B-27
coef 0	Reports coefficients of the curve developed from hi multi-point calibration	B-28
coef 1	Reports coefficients of the curve developed from hi multi-point calibration	B-28
coef 2	Reports coefficients of the curve developed from hi multi-point calibration	B-28
coef o2	Reports/sets current O ₂ coefficient	B-28
contrast	Reports/sets current screen contrast	B-38
copy lrec to sp	Sets/copies current lrec selection into the scratch pad	B-25
copy sp to lrec	Sets/copies current selections in scratch pad into lrec list	B-24
copy sp to srec	Sets/copies current selections in scratch pad into srec list	B-24
copy sp to stream	Sets/copies current selections in scratch pad into stream list	B-24
copy srec to sp	Sets/copies current srec selection into the scratch pad	B-25

C-Link Protocol Commands

Commands

Command	Description	Page
copy stream to sp	Sets/copies current streaming data selection into the scratch pad	B-25
custom	Reports/sets defined custom range concentration	B-36
data treatment lrec	Reports/sets data treatment for concentrations values in lrecs	B-20
data treatment srec	Reports/sets data treatment for concentrations values in srecs	B-20
date	Reports/sets current date	B-39
default params	Sets parameters to default values	B-40
dhcp	Reports/sets state of use of Dynamic Host Host Configuration Protocol (DHCP)	B-43
diag volt iob	Reports diagnostic voltage level for I/O expansion board	B-19
diag volt mb	Reports diagnostic voltage level for motherboard	B-18
diag volt mib	Reports diagnostic voltage level for measurement interface board	B-19
dig in	Reports status of the digital inputs	B-50
din	Reports/sets digital input channel and active state	B-50
do (down)	Simulates pressing down pushbutton	B-33
dout	Reports/sets digital output channel and active state	B-50
dtoa	Reports outputs of the digital to analog converters per channel	B-51
en (enter)	Simulates pressing enter pushbutton	B-33
er	Returns a brief description of the main operating conditions in the format specified in the commands	B-21
erec	Returns a snapshot of the main operating conditions (measurements and status) in the specified format	B-21
erec format	Reports/sets erec format (ASCII or binary)	B-22
erec layout	Reports current layout of erec data	B-23
flags	Reports 8 hexadecimal digits (or flags) that represent the status of the AGC circuit, pressure and temperature compensation status, gas units, gas mode, and alarms	B-13
flow	Reports current measured sample flow in L/min	B-11
format	Reports/sets current reply termination format	B-43
gas mode	Reports current mode of sample, zero, or span	B-36
gas unit	Reports/sets current gas units	B-37
he (help)	Simulates pressing help pushbutton	B-33
high avg time	Reports/sets high range averaging time	B-10

Command	Description	Page
high co	Reports CO concentration calculated with high range coefficients	B-11
high co coef	Reports/sets high range CO coefficients	B-27
high coef 0	Reports coefficients of the curve developed from hi multi-point calibration	B-28
high coef 1	Reports coefficients of the curve developed from hi multi-point calibration	B-28
high coef 2	Reports coefficients of the curve developed from hi multi-point calibration	B-28
high range	Reports/selects current CO high range	B-35
high ratio	Reports sample/reference ratio calculated using the high averaging time	B-13
high sp conc	Reports/sets high span concentration	B-29
host name	Reports/sets host name string	B-44
init ratio	Reports initial sample/reference ratio	B-29
instr name	Reports instrument name	B-44
instrument id	Reports/sets instrument id	B-44
internal temp	Reports current internal instrument temperature	B-12
isc (iscreen)	Retrieves framebuffer data used for the display	B-33
layout ack	Disables stale layout/layout changed indicator ("*")	B-47
le (left)	Simulates pressing left pushbutton	B-33
list din	Lists current selection for digital input	B-52
list dout	Lists current selection for digital output	B-52
list lrec	Lists current selection lrec logging data	B-20
list sp	Lists current selection in the scratchpad list	B-20
list srec	Lists current selection srec logging data	B-20
list stream	Lists current selection streaming data output	B-20
list var aout	Reports list of analog output, index numbers, and variables	B-52
list var din	Reports list of digital input, index numbers, and variables	B-52
list var dout	Reports list of digital output, index numbers, and variables	B-52
low avg time	Reports/sets low averaging time	B-10
low CO	Reports CO concentration calculated with low range coefficients	B-11
low CO coef	Reports/sets low range CO coefficient	B-27
low coef 0	Reports coefficients of the curve developed from lo multi-point calibration	B-28

C-Link Protocol Commands

Commands

Command	Description	Page
low coef 1	Reports coefficients of the curve developed from lo multi-point calibration	B-28
low coef 2	Reports coefficients of the curve developed from lo multi-point calibration	B-28
low range	Reports/sets current CO low range	B-35
low ratio	Reports sample/reference ratio calculated using the low averaging time	B-13
low sp conc	Reports/sets low span concentration	B-29
lr	Reports the last lrec stored	B-21
lrec	Reports maximum number of lrecs	B-21
lrec format	Reports/sets output format for lrecs (ASCII or binary)	B-22
lrec layout	Reports current layout of lrec data	B-23
lrec mem size	Reports maximum number of lrecs that can be stored	B-23
lrec per	Reports/sets lrec logging period	B-23
malloc lrec	Reports/sets memory allocation for lrecs	B-24
malloc srec	Reports/sets memory allocation for srecs	B-24
mb read coils	Reports the current state of the MODBUS coils (digital outputs)	B-49
mb read registers	Reports the current state of the MODBUS registers (analog outputs)	B-49
mb write coil	Sets the current state of the MODBUS coil (digital input)	B-49
me (menu)	Simulates pressing menu pushbutton	B-33
menutext	Displays the text of the menu item where the cursor is currently positioned	B-34
mode	Reports operating mode in local, service, or remote	B-45
motor	Reports motor speed	B-12
no of lrec	Reports/sets number of lrecs stored in memory	B-24
no of srec	Reports/sets number of srecs stored in memory	B-24
o2	Reports the oxygen concentration percent	B-11
o2 corr	Reports/sets oxygen correction (compensation) on or off	B-38
o2 corr conc	Reports/sets the corrected concentration of oxygen	B-11
o2 gas	Reports/sets O ₂ span gas concentration	B-30
o2 temp	Reports temperature of the oxygen sensor	B-12
oc	Reports/sets oxygen correction (compensation) on or off	B-38
power up mode	Reports/sets the power up mode as local or remote	B-46
pres	Reports current reaction chamber pressure	B-12

Command	Description	Page
pres comp	Reports/sets pressure compensation on or off	B-37
program no	Reports analyzer program number	B-47
push	Simulates pressing a key on the front panel	B-33
range	Reports/sets current CO range	B-35
range mode	Reports/sets current range mode	B-36
ratio	Reports sample/reference ratio	B-13
relay stat	Reports/sets relay logic status to for the designated relay(s)	B-52
ri (right)	Simulates pressing right pushbutton	B-33
ru (run)	Simulates pressing run pushbutton	B-33
sample	Sets zero/span valves to sample mode	B-36
save	Stores parameters in FLASH	B-40
save params	Stores parameters in FLASH	B-40
sc (screen)	C-series legacy command that reports a generic response (Use iscreen instead)	B-34
sp conc	Reports/sets span concentration	B-29
sp field	Reports/sets item number and name in scratch pad list	B-25
span	Sets zero/span valves to span mode	B-37
span cal reset	Reports/sets span cal reset on/off	B-30
span calibrate	Sets CO coefficient	B-27
span dev	Reports/sets span deviation (maximum span check offset)	B-31
span dur	Reports/sets how long span gas is sampled by the instrument	B-31
sr	Reports the last srec stored	B-21
srec	Reports maximum number of srecs	B-21
srec format	Reports/sets output format for srecs (ASCII or binary)	B-22
srec layout	Reports current layout of srec data	B-23
srec mem size	Reports maximum number of srecs that can be stored	B-23
srec per	Reports/sets srec logging period	B-23
stream per	Reports/sets current set time interval for streaming data	B-26
stream time	Reports/sets a time stamp to streaming data or not	B-26
temp comp	Reports/sets temperature compensation on or off	B-38
time	Reports/sets current time (24-hour time)	B-40
tz	Reports/sets the timezone string for the network time protocol server	B-47
up	Simulates pressing up pushbutton	B-33

Command	Description	Page
version	Reports version of all the firmware components	B-19
zero	Sets zero/span valves to zero mode	B-37
zero cal reset	Reports/sets zero cal reset on/off	B-31
zero calibrate	Sets CO coefficient	B-26
zero dev	Reports/sets zero deviation (maximum zero check offset)	B-32
zero dur	Reports/sets how long zero gas is sampled by the instrument	B-32
zs avg time	Reports/sets zero/span averaging time	B-33
zs period	Reports/sets zero/span period	B-32

Measurements

avg time

high avg time

low avg time

These commands report the averaging time in seconds when operating in single range, or averaging time used with the high and low ranges when operating in dual or auto range mode. The following example shows that the averaging time is 300 seconds, according to [Table B-3](#).

```
Send:      avg time
Receive:   avg time 11:300 sec
```

set avg time *selection*

set high avg time *selection*

set low avg time *selection*

These commands set the averaging time, high and low averaging times, according to [Table B-3](#). The following example sets the low range averaging time to 120 seconds.

```
Send:      set low avg time 8
Receive:   set low avg time 8 ok
```

Table B-3. Averaging Times

Selection	Averaging Time (seconds)
0	1 seconds
1	2
2	5
3	10
4	20
5	30
6	60

<i>Selection</i>	<i>Averaging Time (seconds)</i>
7	90
8	120
9	180
10	240
11	300

co

high co

low co

These commands report the measured CO concentration when operating in single range, or high and low CO when operating in dual or auto range mode. The following example shows that the CO concentration is 40 ppm.

```
Send:      CO
Receive:   CO 4.000E+1 ppm
```

o2

This command reports the oxygen concentration in percent. The following example reports that the current O₂ concentration is 15%.

```
Send:      o2
Receive:   o2 15.00 %
```

o2 corr conc

This command reports the oxygen correction concentration in percent. The following example shows that the O₂ correction concentration is 15%.

```
Send:      o2 corr conc
Receive:   o2 corr conc 15.00 %
```

set o2 corr conc *value*

value = 0 to 20.9

This command sets the oxygen correction concentration value to *value*, where *value* is a floating-point number representing the oxygen correction concentration in percent. The following example sets the O₂ corrected concentration value to 15.00%.

```
Send:      set o2 corr conc 15
Receive:   set o2 corr conc 15 ok
```

flow

This command reports the current sample flow. The following example reports that the current sample flow is 1.108 liters/minute.

Send: flow
Receive: flow 1.108 1/m

chamber temp

This command reports the current optical bench temperature. The following example reports that the current optical bench temperature is 45.2 °C.

Send: chamber temp
Receive: chamber temp 45.2 deg C

internal temp

This command reports the current internal instrument temperature. The first reading is the temperature being used in instrument calculations. The second temperature is the actual temperature being measured. If temperature compensation is on, then both temperature readings are the same. If temperature compensation is off, a temperature of 30 °C is used as the default temperature even though the actual internal temperature is 27.2 °C. The following example shows that temperature compensation is on and that the internal temperature is 27.2 °C.

Send: internal temp
Receive: internal temp 27.2 deg C

motor

This command reports the current motor speed. The following example reports that the current motor speed is 100%.

Send: motor
Receive: motor 100%

o2 temp

This command reports the current oxygen sensor temperature, in degrees C. The following example reports that the O₂ sensor temperature is 31 °C.

Send: o2 temp
Receive: o2 temp 31.0 deg C

pres

This command reports the current reaction chamber pressure. The first pressure reading is the pressure reading being used in instrument calculations. The second pressure is the actual pressure reading being measured. If pressure compensation is on, then both pressure readings are the same. If pressure compensation is off, a pressure of 760 mmHg is used as default pressure even though the actual pressure is 753.4 mmHg. The following example shows that the actual reaction chamber pressure is 753.4 mmHg.

Send: pres
Receive: pres 753.4 mmHg

ratio
high ratio
low ratio

The “ratio” command reports the sample/reference ratio in single mode. The “high ratio” commands reports the sample/reference ratio using high averaging time and the “low ratio” command using low averaging time, when operating in dual or auto mode. The following example shows that the current ratio is 1.161100.

Send: ratio
Receive: ratio 1.161100

flags

This reports 8 hexadecimal digits (or flags) that represent the status of the AGC circuit, pressure and temperature compensation status, gas units, gas mode, and alarms. To decode the flags, each hexadecimal digit is converted to binary as shown in the Figure B–1. It is the binary digits that define the status of each parameter. In the following example, the instrument is reporting that the AGC circuit is on, that the instrument is in the span gas mode, and that the CO high concentration alarm is activated.

Send: flags
Receive: flags 80068000

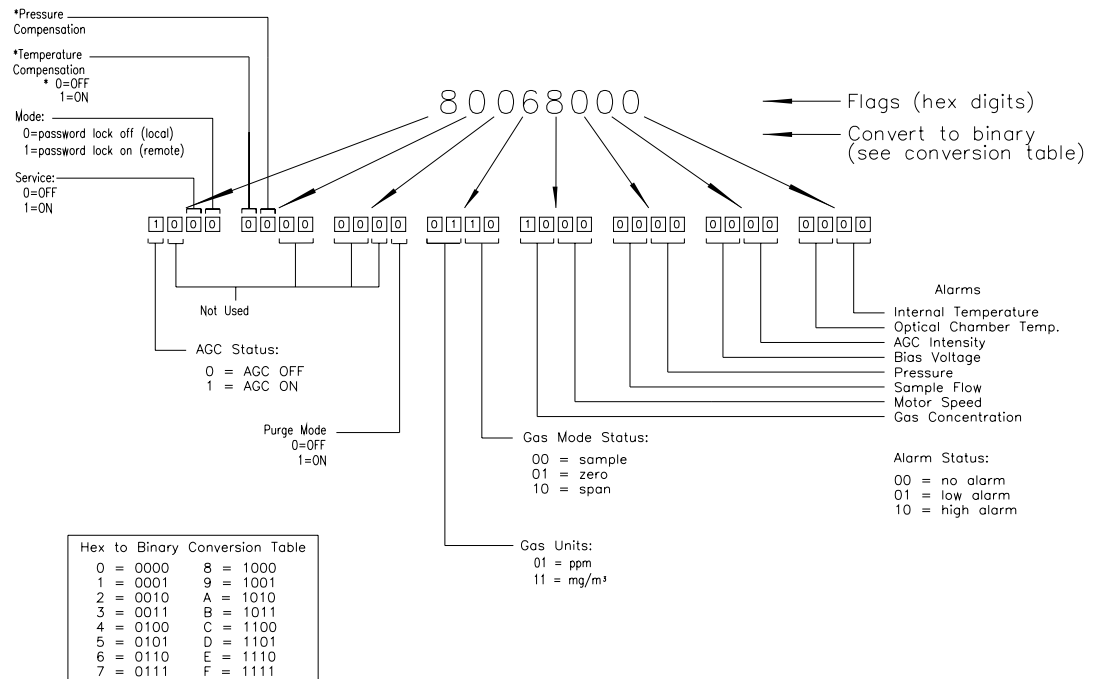

Figure B–1. Flags Field

Alarms

alarm agc intensity min

alarm agc intensity max

These commands report the agc intensity alarm minimum and maximum value current settings. The following example reports that the agc intensity alarm minimum value is 20.

```
Send:      alarm agc intensity min
Receive:   alarm agc intensity min 20
```

set alarm agc intensity min *value*

set alarm agc intensity max *value*

These commands set the agc intensity alarm minimum and maximum values to *value*, where *value* is a floating-point number representing agc intensity alarm limits. The following example sets the agc intensity alarm maximum value to 20.

```
Send:      set alarm agc intensity max 20
Receive:   set alarm agc intensity max 20 ok
```

alarm bias voltage min

alarm bias voltage max

These commands report the bias voltage alarm minimum and maximum value current settings. The following example reports that the bias voltage alarm minimum value is -128.

```
Send:      alarm bias voltage min
Receive:   alarm bias voltage min -128
```

set alarm bias voltage min *value*

set alarm bias voltage max *value*

These commands set the bias voltage alarm minimum and maximum values to *value*, where *value* is a floating-point number representing bias voltage alarm limits. The following example sets the bias voltage alarm maximum value to -110.

```
Send:      set alarm bias voltage max -110
Receive:   set alarm bias voltage max -110 ok
```

alarm chamber temp min

alarm chamber temp max

These commands report the bench temperature alarm minimum and maximum value current settings. The following example reports that the bench temperature alarm minimum value is 35.0 °C.

```
Send:      alarm chamber temp min
Receive:   alarm chamber temp min 35.0 deg C
```

set alarm chamber temp min *value*

set alarm chamber temp max *value*

These commands set the bench temperature alarm minimum and maximum values to *value*, where *value* is a floating-point number representing bench temperature alarm limits in degrees C. The following example sets the bench temperature alarm maximum value to 55.0 °C.

```
Send:          set alarm chamber temp max 55.0
Receive:       set alarm chamber temp max 55.0 ok
```

alarm conc min

alarm conc max

These commands report the CO concentration alarm minimum and maximum values current setting. The following example reports that the CO concentration minimum is 5.2 ppm.

```
Send:          alarm conc min
Receive:       alarm conc min 5.2 ppm
```

set alarm conc min *value*

set alarm conc max *value*

These commands set the CO concentration alarm minimum and maximum values to *value*, where *value* is a floating-point representation of the concentration alarm limits. Values must be in the units that are currently set for use. The following example sets the CO concentration alarm maximum value to 215.

```
Send:          set alarm conc max 215
Receive:       set alarm conc max 215 ok
```

alarm conc o2 min

alarm conc o2 max

These commands report the current oxygen concentration alarm minimum and maximum value settings. The following example reports that the O₂ concentration alarm minimum value is 10%.

```
Send:          alarm conc o2 min
Receive:       alarm conc o2 min 10.00 %
```

set alarm conc o2 min *value*

set alarm conc o2 max *value*

These commands set the oxygen concentration alarm minimum and maximum values to *value*, where *value* is a floating-point number representing the oxygen concentration alarm limits in percent. The following example sets the O₂ concentration alarm maximum value to 100.00%.

```
Send:          set alarm conc o2 max 100
Receive:       set alarm conc o2 max 100 ok
```

alarm internal temp min**alarm internal temp max**

These commands report the internal temperature alarm minimum and maximum value current settings. The following example reports that the internal temperature alarm minimum value is 15.0 °C.

```
Send:          alarm internal temp min
Receive:       alarm internal temp min 15.0 deg C
```

set alarm internal temp min *value***set alarm internal temp max *value***

These commands set the internal temperature alarm minimum and maximum values to *value*, where *value* is a floating-point number representing internal temperature alarm limits in degrees C. The following example sets the internal temperature alarm maximum value to 45.0 °C.

```
Send:          set alarm internal temp max 45
Receive:       set alarm internal temp max 45 ok
```

alarm motor speed min**alarm motor speed max**

These commands report the motor speed alarm minimum and maximum value current settings. The following example reports that the motor speed alarm minimum value is 99.8 %.

```
Send:          alarm motor speed min
Receive:       alarm motor speed min 99.8
```

set alarm motor speed min *value***set alarm motor speed max *value***

These commands set the motor speed alarm minimum and maximum values to *value*, where *value* is a floating-point number representing motor speed alarm limits in minutes. The following example sets the motor speed alarm maximum value to 100.2 %.

```
Send:          set alarm motor speed max 100.2
Receive:       set alarm motor speed max 100.2 ok
```

alarm pressure min**alarm pressure max**

These commands report the pressure alarm minimum and maximum value current settings. The following example reports that the pressure alarm minimum value is 650 mmHg.

```
Send:      alarm pressure min
Receive:   alarm pressure min 650 mmHg
```

set alarm pressure min *value***set alarm pressure max *value***

These commands set the pressure alarm minimum and maximum values to *value*, where *value* is a floating-point number representing pressure alarm limits in millimeters of mercury. The following example sets the pressure alarm maximum value to 790 mmHg.

```
Send:      set alarm pressure max 790
Receive:   set alarm pressure max 790 ok
```

alarm sample flow min**alarm sample flow max**

These commands report the sample flow alarm minimum and maximum value current settings. The following example reports that the sample flow alarm minimum value is 0.350 L/min.

```
Send:      alarm sample flow min
Receive:   alarm sample flow min 0.350 l/min
```

set alarm sample flow min *value***set alarm sample flow max *value***

These commands set the sample flow alarm minimum and maximum values to *value*, where *value* is a floating-point number representing sample flow alarm limits in liters per minute. The following example sets the sample flow alarm maximum value to 1 L/min.

```
Send:      set alarm sample flow max 1.000
Receive:   set alarm sample flow max 1.000 ok
```

alarm trig conc

This command reports the CO concentration alarm trigger action for minimum alarm, current setting, to either floor or ceiling. The following example shows the CO concentration minimum alarm trigger to ceiling, according to [Table B-4](#).

```
Send:      alarm trig conc
Receive:   alarm trig conc 1
```

set alarm trig conc *value*

This command sets the CO concentration alarm minimum *value*, where *value* is set to either floor or ceiling, according to [Table B-4](#). The following example sets the CO concentration minimum alarm trigger to ceiling.

```
Send:      set alarm trig conc 1
Receive:   set alarm trig conc 1 ok
```

Table B-4. Alarm Trigger Values

<i>Value</i>	Alarm Trigger
00	Floor
01	Ceiling

alarm trig conc o2

This command reports the O₂ concentration alarm trigger action for minimum alarm, current setting, to either floor or ceiling. The following example shows the O₂ concentration minimum alarm trigger set to ceiling, according to [Table B-4](#).

Send: alarm trig conc o2
Receive: alarm trig conc o2 1

set alarm trig conc o2 *value*

This command sets the O₂ concentration alarm minimum *value*, where *value* is set to either floor or ceiling, according to [Table B-4](#). The following example sets the O₂ concentration minimum alarm trigger to ceiling.

Send: set alarm trig conc o2 1
Receive: set alarm trig conc o2 1 ok

Diagnostics

agc int

This command reports the current intensity of the reference channel AGC circuit. The following example reports that the current AGC intensity is 200,000 Hz.

Send: agc int
Receive: agc int 200000 Hz

bias voltage

This command reports the current IR bias supply voltage. The following example reports that the bias voltage is -102.3 volts

Send: bias voltage
Receive: bias voltage -102.3 V

diag volt mb

This command reports the diagnostic voltage measurements on the motherboard. The sequence of voltages is: Positive 24, positive 15, positive 5, positive 3.3, and negative 3.3. Each voltage value is separated by a space.

Send: diag volt mb
Receive: diag volt mb 24.1 14.9 4.9 3.2 -3.2

diag volt mib

This command reports the diagnostic voltage measurements on the measurement interface board. The sequence of voltages is: Positive 24, positive 15, negative 15, positive 5, positive 3.3, positive 18 IR, positive 18 MOT, and VBIAS. Each voltage value is separated by a space.

```
Send:      diag volt mib
Receive:   diag volt mib 24.1 14.9 -14.9 4.9 3.2 17.9 17.9
```

diag volt iob

This command reports the diagnostic voltage measurements on the I/O expansion board. The sequence of voltages is: Positive 24, positive 5, positive 3.3, and negative 3.3. Each voltage value is separated by a space.

```
Send:      diag volt iob
Receive:   diag volt iob 24.1 4.9 3.2 -3.2
```

version

This command reports the version of all the firmware components. The example that follows shows a list of firmware components that were displayed by issuing the version command. The components displayed will vary depending on the configuration of the instrument.

```
Send:      version
Receive:   version
           Program = 01.05.79.225
           Library = 01.01.60.167
           Kernel = 2.4.24-uc0-003-Thermo
           Board = 81, File = /usr/application.hex
           Board App = 11.3.100 Bl 4.0.97
           File App = 11.3.100 Bl 4.0.97
           Board = 84, File = /usr/application.hex
           Board App = 11.3.100 Bl 4.0.97
           File App = 11.3.100 Bl 4.0.97
           Arc Bl = 170711
```

Datalogging

clr records

This command will clear all lrecs and srecs that have been saved.

```
Send:      clr records
Receive:   clr records ok
```

set clr lrecs

set clr srecs

These commands will clear only the lrecs or only the srecs that have been saved. The following example clears srecs.

```
Send:      set clr srecs
Receive:   set clr srecs ok
```

data treatment lrec

data treatment srec

These commands report the current selection of data treatment for concentrations in the lrecs or srecs. The following example reports the data treatment for concentrations in lrec as minimum.

```
Send:      data treatment lrec
Receive:   data treatment lrec min
```

set data treatment lrec *string*

set data treatment srec *string*

string = | cur | avg | min | max |

These commands set the data treatment to current, average, minimum, or maximum for the concentration values recorded in the lrecs or srecs. The following example sets the data treatment for concentrations in lrec as minimum.

```
Send:      set data treatment lrec min
Receive:   set data treatment lrec min ok
```

list lrec

list srec

list stream

list sp

These commands report the list of current selections for lrec logging data, srec logging data, streaming data output, or the scratch pad (sp) list.

The scratch pad is a temporary memory area which is used to set up lists of selections for lrec, srec, or streaming data items. The user can copy any of these lists to the scratch pad, modify individual elements in the list, then save the scratch pad back to the original list. Refer to the “sp field” command for information on how to edit the scratch pad.

The following example shows the list for streaming data output.

```
Send:      list stream
Receive:   list stream
           field index variable
           x x time
           1 10 auxt
           2 13 pres
           3 14 smpfl
           4 15 intensity
```

erec

erxy

$x = | 0 | 1 |$: Reply termination format (see “set format *format*” command)

$y = | 0 | 1 | 2 |$: Output format (see “set erex format *format*” command)

These commands return a snapshot of the main operating conditions (measurements and status) at the time the command is issued. The following example shows a typical response.

The format is defined within the command (in the case of erxy) or by the current settings of the "format" and "erec format" commands (in the case of erex). For details on erex formatting, see the “[Record Layout Definition](#)” section at the end of this appendix. For details on how to decode the flag fields within these records, see the "flags" command.

```
Send:          erex
Receive:       erex
              09:48 04-06-05 flags 9C040510 C0 0.000 4 loC0 -0.002
              4 s/r 0.000 los/r 0.902 biasv -112.668 agci 96.500 intt
              34.023 cht 47.995 smpfl 0.000 pres 0.000 avgt1 10 avgt2
              10 C0bkg -0.000 C0coef 1.000 loC0coef 1.000 C0range
              10000000.000 loC0range 10000000.000 motor 100.000
```

lrec

srec

lrec *rec num*

srec *rec num*

lrx *rec num*

srx *rec num*

lrec *aa:bb oo-pp-qq yy*

srec *aa:bb oo-pp-qq yy*

rec = The starting record index number (1=most recent)

num = The number of records to return (1 to 10)

$x = | 0 | 1 |$: Reply termination format (see “set format *format*” command)

$y = | 0 | 1 | 2 |$: Output format (see “set lrec/srec format *format*” command)

aa = hours (01 to 23)

bb = minutes (01 to 59)

oo = month (01 to 12)

pp = day (01 to 31)

qq = year

These commands output lrec or srec logged data. The output format is determined by the “set lrec format”, and “set srec format” commands. The logging time is determined by the “set lrec per” and “set srec per” commands.

In the following example, assume there are 740 lrecs currently stored in memory. When the command “lrec 100 5” is sent, the instrument counts back 100 records from the last record collected (record 740), and then returns 5 records: 640, 641, 642, 643, and 644. For details on how to decode the flag fields within these records, see [Figure B-1](#).

```
Send:      lrec 5
Receive:   lrec 100 5
           10:15 05-12-03 flags 9c040000 CO 7349E+0 loCO 5994E+0
           intt 33.2 cht 44.7 pres 758.9 smp1fl 1.085 speed 100.0
           biasv -115.5 intensity 1999940
           10:15 05-12-03 flags 9c040000 CO 7349E+0 loCO 5994E+0
           intt 33.2 cht 44.7 pres 758.9 smp1fl 1.085 speed 100.0
           biasv -115.5 intensity 1999940
           10:15 05-12-03 flags 9c040000 CO 7349E+0 loCO 5994E+0
           intt 33.2 cht 44.7 pres 758.9 smp1fl 1.085 speed 100.0
           biasv -115.5 intensity 1999940
           10:15 05-12-03 flags 9c040000 CO 7349E+0 loCO 5994E+0
           intt 33.2 cht 44.7 pres 758.9 smp1fl 1.085 speed 100.0
           biasv -115.5 intensity 1999940
           10:15 05-12-03 flags 9c040000 CO 7349E+0 loCO 5994E+0
           intt 33.2 cht 44.7 pres 758.9 smp1fl 1.085 speed 100.0
           biasv -115.5 intensity 1999940
```

lrec format

srec format

erec format

These commands report the output format for lrecs and srecs, and erec data in various formats such as ASCII without text, ASCII with text, or binary. The following example shows the output format for lrecs is ASCII with text, according to [Table B-5](#).

```
Send:      lrec format
Receive:   lrec format 1
```

set lrec format *format*

set srec format *format*

set erec format *format*

These commands set the output format for lrecs and srecs, and erec data, according to [Table B-5](#). The following example sets the lrec output format to ASCII with text.

```
Send:      set lrec format 1
Receive:   set lrec format 1 ok
```

Table B-5. Record Output Formats

<i>Format</i>	Output Format
0	ASCII no text
1	ASCII with text
2	Binary data

lrec layout

srec layout

erec layout

These commands report the layout (string indicating the data formats) for data that is sent out in response to the erec, lrec, srec, and related commands. For details on how to interpret the strings, see “Record Layout Definition” later in this appendix.

```
Send:      lrec layout
Receive:   lrec layout %s %s %lx %f %f %f %f
           t D L ffff
           s/r pres intensity motor
```

lrec mem size

srec mem size

These commands report the number of lrecs and srecs that can be stored with the current settings and the number of blocks reserved for lrecs and srecs. The example that follows shows that 1075 blocks were reserved for lrecs and the maximum number of lrecs that can be stored in memory is 241979. Memory allocation can be changed using the malloc command.

```
Send:      lrec mem size
Receive:   lrec mem size 241979 recs, 1075 blocks
```

lrec per

srec per

These commands report the lrecs and srecs logging period. The following example shows that the srec logging period is 5 minutes.

```
Send:      srec per
Receive:   srec per 5 min
```

set srec per *value*

set lrec per *value*

value = | 1 | 5 | 15 | 30 | 60 |

These commands set the lrecs and srecs logging period to *value* in minutes. The following example sets the lrec logging period to 15 minutes.

```
Send:      set lrec per 15
Receive:   set lrec per 15 ok
```

no of lrec

no of srec

These commands report the number of lrecs and srecs stored memory. The following example shows that 50 lrecs have been stored in the memory.

```
Send:      no of lrec
Receive:   no of lrec 50 recs
```

malloc lrec

malloc srec

These commands report the currently set memory allocation for lrecs and srecs in percent of total memory.

```
Send:      malloc lrec
Receive:   malloc lrec 10 %
```

set malloc lrec *value*

set malloc srec *value*

value = 0 to 100

These commands set the percent of memory space allocated for lrecs and srecs to *value*, where *value* is a floating-point number representing percent. The following example sets the memory allocation for lrecs to 10%.

Note Issuing these commands will clear all the logged data in memory. All the existing records should be retrieved using appropriate commands, if required. ▲

```
Send:      set malloc lrec 10
Receive:   set malloc lrec 10 ok
```

set copy sp to lrec

set copy sp to srec

set copy sp to stream

These commands copy the current selections in scratch pad (sp) into the lrec, srec, or streaming data list.

The scratch pad is a temporary memory area which is used to set up lists of selections for lrec, srec, or streaming data items. The user can copy any of these lists to the scratch pad, modify individual elements in the list, then save the scratch pad back to the original list. For more information on how to edit the scratch pad, see the “sp field” command.

The following example copies the current list in scratch pad into the lrecs list.

```
Send:      set copy sp to lrec
Receive:   set copy sp to lrec ok
```

set copy lrec to sp

set copy srec to sp

set copy stream to sp

These commands copy the current contents of the lrec, srec, or streaming data list into the scratch pad (sp). These commands are useful in easy modification of current lrec, srec, or streaming data lists.

The scratch pad is a temporary memory area which is used to set up lists of selections for lrec, srec, or streaming data items. The user can copy any of these lists to the scratch pad, modify individual elements in the list, then save the scratch pad back to the original list. For more information on how to edit the scratch pad, see the “sp field” command.

The following example copies the current list of lrecs into the scratch pad.

```
Send:      set copy lrec to sp
Receive:   set copy lrec to sp ok
```

sp field *number*

This command reports the variable *number* and name stored at the index in the scratch pad list.

The scratch pad is a temporary memory area which is used to set up lists of selections for lrec, srec, or streaming data items. The user can copy any of these lists to the scratch pad, modify individual elements in the list, then save the scratch pad back to the original list.

The following example shows that field 5 in the scratch pad is set to index number 8, which is for internal temperature.

```
Send:      sp field 5
Receive:   sp field 5 8 int temp
```

set sp field *number value*

number = 1-32 for lrec and srec lists, 1-8 for streaming data lists

This command sets the scratch pad field *number* (item number in scratch pad list) to *value*, where *value* is the index number of a variable in the analog output variable list. Available variables and their corresponding index numbers may be obtained using the command “list var aout”. The “set sp field” command is used to create a list of variables which can then be transferred into the lrec, srec, or streaming data lists, using the “set copy sp to lrec”, “set copy sp to srec”, or “set copy sp to stream” commands.

```
Send:      set sp field 1 5
Receive:   set sp field 1 5 ok
```

stream per

This command reports the current time interval in seconds for streaming data. The following example reports the streaming period is set to 10 seconds.

```
Send:      stream per
Receive:   stream per 10
```

set stream per *number value*

number value = | 1 | 2 | 5 | 10 | 20 | 30 | 60 | 90 | 120 | 180 | 240 | 300 |

This command sets the time interval between two consecutive streaming data strings to *number value* in seconds. The following example sets the number value to 10 seconds.

```
Send:      set stream per 10
Receive:   set stream per 10 ok
```

stream time

This command reports if the streaming data string will have a time stamp attached to it or not, according to [Table B-6](#). The following example reports that the streaming data shall not include a time stamp.

```
Send:      stream time
Receive:   stream time 0
```

set stream time *value*

This command enables *value*, where *value* is to attach or disable time stamp to streaming data string, according to [Table B-6](#). The following example attaches a time stamp to streaming data.

```
Send:      set stream time 0
Receive:   set stream time 0 ok
```

Table B-6. Stream Time Values

<i>Value</i>	Stream Time
0	Disables time stamp to streaming data string
1	Attaches time stamp to streaming data string

Calibration

set cal co bkg

set zero calibrate

These commands will set the CO background. The following example shows a successful auto-calibration of the CO background.

Note Zero air must be provided to the instrument prior to issuing any of these commands. ▲

```
Send:      set cal co bkg
Receive:   set cal co bkg ok
```

cal bkg o2

This command will set O₂ background so the O₂ concentration reads 0.00%. The example below shows a successful auto-calibration of the O₂ background.

```
Send:      set cal bkg o2
Receive:   set cal bkg o2 ok
```

set cal co coef

set cal high co coef

set cal low co coef

set span calibrate

set calibrate

These commands will set CO coefficients based on CO span gas concentrations. The high and low commands are only available in dual and auto range mode. If the mode is incorrect, the instrument responds with “can’t, wrong settings”. The following example shows a successful auto-calibration of the low CO coefficient.

Note Span gas must be provided to the instrument prior to issuing any of these commands. ▲

```
Send:      set cal low CO coef
Receive:   set cal low CO coef ok
```

cal coef o2

This command will set O₂ coefficient based on O₂ span gas concentrations. The example below shows a successful auto-calibration of the O₂ coefficient.

```
Send:      set cal coef o2
Receive:   set cal coef o2 ok
```

co coef

high co coef

low co coef

These commands report the current CO coefficient in single range mode, or the high and low range coefficient in dual or auto range mode. If the mode is incorrect, the instrument responds with “can’t, wrong settings”. The following example reports that the CO coefficient is 1.200.

Send: CO coef
Receive: CO coef 1.200

set co coef *value*

set high co coef *value*

set low co coef *value*

These commands set the CO coefficients to a user-defined *value*, where *value* is a floating-point representation of the coefficient. The following example sets the CO coefficient to 1.200.

Send: set CO coef 1.200
Receive: set CO coef 1.200 ok

coef o2

This command reports the O₂ coefficient. The example below reports that the O₂ coefficient is 1.000.

Send: coef o2
Receive: coef o2 1.000

set coef o2 *value*

This command sets the O₂ coefficient to a user-defined *value*, where *value* is a floating-point representation of the coefficient. The example below sets the O₂ coefficient to 1.005.

Send: set coef o2 1.005
Receive: set coef o2 1.005 ok

coef 0

coef 1

coef 2

high coef 0

high coef 1

high coef 2

low coef 0

low coef 1

low coef 2

The “coef 0”, coef 1”, and coef 2” commands report the coefficients of the curve developed from the Hi Multi-Point Calibration in single range mode. The “high coef 0”, high coef 1”, and high coef 2” commands report the coefficients of the curve developed from the Hi Multi-Point Calibration in dual or auto range mode. The “low coef 0”, low coef 1”, and low coef 2” commands report the coefficients of the curve developed from the Lo Multi-Point Calibration in dual and auto range mode. The following example reports the coefficient 0 having a value of 1.005.

Send: coef 0
Receive: coef 0 1.005 ok

co bkg

This command reports the current CO backgrounds. The following example reports that the CO background is 1.4 ppm.

```
Send:      co bkg
Receive:   co bkg 1.4 ppm
```

set co bkg *value*

This command is used to set the CO background to a user-defined *value*, where *value* is a floating-point representation of the background in the currently selected units. The following example sets the CO background to 1.4 ppm.

```
Send:      set co bkg 1.400
Receive:   set co bkg 1.400 ok
```

bkg o2

This command reports the oxygen background concentration in percent. The following example reports that the current O₂ background concentration is 1.5%.

```
Send:      bkg o2
Receive:   bkg o2 1.50 %
```

set bkg o2

This command is used to set the oxygen background concentration in percent. The example below sets the O₂ background concentration to 1.5%.

```
Send:      set bkg o2 1.5
Receive:   set bkg o2 1.5 ok
```

init ratio

This command reports the initial sample/reference ratio. The following example reports that the initial ratio was 1.16210.

```
Send:      initial ratio
Receive:   initial ratio 1.16210
```

sp conc**high sp conc****low sp conc**

These commands report span concentration in single range mode, or the high and low span concentrations in dual or auto range mode. If the mode is incorrect, the instrument responds with “can’t, wrong settings”. The following example reports the span gas concentration in single range mode.

Send: sp conc
Receive: sp conc 1000

set sp conc *value*

set high sp conc *value*

set low sp conc *value*

These commands set the span concentration to a user-defined *value*, where *value* is a floating-point representation of the span concentration in the currently selected units. The following example sets the span concentration to 1000 ppm in the single range mode.

Send: set sp conc 1000
Receive: set sp conc 1000 ok

o2 gas

This command reports the O₂ span gas concentrations used to auto-calibrate O₂ coefficients. The example below reports that the O₂ span gas concentration is 20.8%.

Send: o2 gas
Receive: o2 gas 20.8 %

set o2 gas *value*

This command sets the O₂ span gas concentration used by the auto-calibration routine to *value*, where *value* is a floating-point representation of the gas concentration in percent. The gas units are the same as those chosen by the user. The example below sets the O₂ span gas concentration to 20.8 %.

Send: set o2 gas 20.8
Receive: set o2 gas 20.8 ok

span cal reset

This command reports that the span cal reset is on or off. The following example reports that the span cal reset is on.

Send: span cal reset
Receive: span cal reset on

set span cal reset *onoff*

onoff = | on | off |

This command sets the span cal reset to on or off. The following example sets the span cal reset to off.

Send: set span cal reset off
Receive: set span cal reset off ok

span dev

This command reports the span deviation (span check offset). The following example reports that the span deviation is 1 ppb.

```
Send:      span dev
Receive:   span dev 1.000 E+00
```

set span dev *value*

This command sets the span deviation (span check offset) to *value*, where *value* is a floating-point representation of the gas concentration in current selected units. The following example sets the span deviation to 345 ppb.

```
Send:      set span dev 345
Receive:   set span dev 345 ok
```

span dur

This command reports the span duration. The following example reports that the span duration min is 10 minutes.

```
Send:      span dur
Receive:   span dur 10 min
```

set span dur *value*

This command sets span duration to *value* where *value* represents the span duration in minutes. The following example sets the span duration to 15 minutes.

```
Send:      set span dur 15
Receive:   set span dur 15 ok
```

zero cal reset

This command reports that the zero cal reset is on or off. The following example reports that the zero cal reset is off.

```
Send:      zero cal reset
Receive:   zero cal reset off
```

set zero cal reset *onoff*

onoff = | on | off |

This command sets the zero cal reset on or off. The following example turns the zero cal reset off.

```
Send:      set zero cal reset off
Receive:   set zero cal reset off ok
```

zero dev

This command reports the zero deviation (maximum zero check offset). The following example reports that the zero deviation is 10 ppb.

```
Send:          zero dev
Receive:       zero dev 1.000 E+01
```

set zero dev *value*

This command sets the zero deviation (maximum zero check offset) to *value*, where *value* is a floating-point representation of the gas concentration in current selected units. The following example sets the zero deviation to 10 ppb.

```
Send:          set zero dev 1.000 E+01
Receive:       set zero dev 1.000 E+01 ok
```

zero dur

This command reports the zero duration. The following example reports that the zero duration is 10 minutes.

```
Send:          zero dur 10
Receive:       zero dur 10 ok
```

set zero dur *value*

This command sets the zero duration to *value* where *value* represents the zero duration in minutes. The following example sets the zero duration to 15 minutes.

```
Send:          set zero dur 15
Receive:       set zero dur 15 ok
```

zs period

This command reports the zero/span (zs) period. The following example reports that the zero/span period is 24 hours.

```
Send:          zs period
Receive:       zs period 24 hr
```

set zs period *value*

This command sets zero/span (zs) period to *value*, where *value* represents the zero/span period in hours. The following example sets the zero/span period to 24 hours.

```
Send:          set zs period 24
Receive:       set zs period 24 ok
```

zs avg time

This command reports the zero/span (zs) averaging time in seconds. The following example reports that the zero/span averaging time is 30 seconds, according to [Table B-3](#).

```
Send:      zs avg time
Receive:   zs avg time 5:30 sec
```

set avg time *value*

This command sets the zero/span averaging time, according to [Table B-3](#). The following example sets the zero/span averaging time to 120 seconds.

```
Send:      set zs avg time 8
Receive:   set zs avg time 8 ok
```

Keys/Display

push *button*

do	ri
down	right
en	ru
enter	run
he	up
help	1
le	2
left	3
me	4

menu

button = | do | down | en | enter | he | help | le | left | me | menu | ri | right | ru | run | up | 1 | 2 | 3 | 4 |

These commands simulate pressing the front panel pushbuttons. The numbers represent the front panel soft keys, from left to right.

```
Send:      push enter
Receive:   push enter ok
```

isc

iscreen

These commands retrieve the framebuffer data used for the display on the *iSeries* instrument. It is 19200 bytes in size, 2-bits per pixel, 4 pixels per byte arranged as 320 by 240 characters. The data is sent in RLE encoded form to save time in transmission. It is sent as a type '5' binary C-Link response with no checksum.

The RLE encoding consists of a 0 followed by an 8-bit count of consecutive 0xFF bytes. The following 'c' code will expand the incoming data.

```
void      unpackDisplay ( void far* tdib, unsigned char far* rlescreen )
{
int i,j,k;
unsigned char far *sc4bpp, *sc2bpp, *screen, *ptr;

ptr = screen = (unsigned char far *)malloc(19200);
//RLE decode the screen
for (i=0; i<19200 && (ptr - screen) < 19200; i++)
{
*(ptr++) = *(rlescreen + i);
if (*(rlescreen + i) == 0)
{
unsigned char rlecount = *(unsigned char *)(rlescreen + ++i);

while (rlecount)
{
*(ptr++) = 0;
rlecount--;
}
}
else if (*(rlescreen + i) == 0xff)
{
unsigned char rlecount = *(unsigned char *)(rlescreen + ++i);

while (rlecount)
{
*(ptr++) = 0xff;
rlecount--;
}
}
}
}
}
```

To convert this data into a BMP for use with Windows, it needs to be saved as a 4-bit-per-pixel gray-scale image. Also note that BMP files are upside down relative to this data, i.e. the top display line is the last line in the BMP.

menutext

This command displays the text of the menu item where the cursor is currently positioned. The following example shows that the cursor is positioned at the instrument controls menu item.

```
Send:      menutext
Receive:   menutext      main menu      instrument controls
```

sc

screen

These commands are meant for backward compatibility with the C series. Screen information is instead reported using the “iscreen” command above.

```
Send:      screen
Receive:   screen This is an ISeries instrument.
           Screen information not available.
```

Measurement Configuration

range
high range
low range

These commands report CO range in single range mode, or the high and low ranges in dual or auto range mode. If the mode is incorrect, the instrument responds with “can’t, wrong settings”. The following example reports that the CO full-scale range is set to 50 ppm, according to [Table B-7](#).

```
Send:      range
Receive:   range 5: 5.000E+01 ppb
```

set range *selection*
set high range *selection*
set low range *selection*

These commands select the CO full-scale ranges, according to [Table B-7](#). The following example sets the CO full-scale range to 50 ppm.

```
Send:      set range 5
Receive:   set range 5 ok
```

Table B-7. Standard Ranges

<i>Selection</i>	ppm	mg/m³
0	1	1
1	2	2
2	5	5
3	10	10
4	20	20
5	50	50
6	100	100
7	200	200
8	500	500
9	1000	1000
10	2000	2000
11	5000	5000
12	10000	10000
13	C1	C1
14	C2	C2
15	C3	C3

custom range

range = | 1 | 2 | 3 |

This command reports the user-defined value of custom range 1, 2, or 3. The following example reports that custom range 1 is defined to 5.50 ppm.

Send: custom 1
Receive: custom 1 5.500E+3 ppm

set custom range range value

set custom 1 range value

set custom 2 range value

set custom 3 range value

These commands are used to set the maximum concentration for any of the three custom ranges 1, 2, or 3 to range *value*, where *value* is a floating-point number representing concentration in ppm or mg/m³. The following example sets the custom 1 range to 55.5 ppm.

Send: set custom 1 range 55.5
Receive: set custom 1 range 55.5 ok

range mode

This command reports the current range mode.

Send: range mode
Receive: range mode single

set range mode mode

This command sets the current range mode to single, dual, or auto. The following example sets the range mode to single.

Send: set range mode single
Receive: set range mode single ok

gas mode

This command reports the current state of the zero/span valves gas mode as sample, zero, or span. The following example reports that the gas mode is sample.

Send: gas mode
Receive: gas mode sample

set sample

This command sets the zero/span valves to the sample mode. The following example sets the instrument to sample mode, that is, the instrument is reading the sample gas.

Send: set sample
Receive: set sample ok

set zero

This command sets the zero/span valves to the zero mode. The following example sets the instrument to zero mode that is, the instrument is reading the zero gas.

Send: set zero
Receive: set zero ok

set span

This command sets the zero/span valves to the span mode. The following example sets the instrument to span mode that is, the instrument is reading span gas.

Send: set span
Receive: set span ok

gas unit

This command reports the current gas units (ppm or mg/m³). The example reports that the gas unit is set to ppm.

Send: gas unit
Receive: gas unit ppm

set gas unit *unit*

unit = | ppm | mg/m³ |

This command sets the gas units to ppm or mg/m³. The following example sets the gas units to mg/m³.

Send: set gas unit mg/m3
Receive: set gas unit mg/m3 ok

pres comp

This command reports whether pressure compensation is on or off. The following example shows that pressure compensation is on.

Send: pres comp
Receive: pres comp on

set pres comp *onoff*

onoff = | on | off |

These commands turn the pressure compensation *on* or *off*. The following example turns pressure compensation off.

Send: set pres comp off
Receive: set pres comp off ok

temp comp

This command reports whether temperature compensation is on or off. The following example shows the temperature compensation is off.

Send: temp comp
Receive: temp comp off

set temp comp *onoff*

onoff = | on | off |

These commands turn the temperature compensation *on* or *off*. The following example turns temperature compensation off.

Send: set temp comp off
Receive: set temp comp off ok

oc

o2 corr

These command report whether oxygen correction (compensation) is on or off. The following example reports that the O₂ correction is on.

Send: o2 corr
Receive: o2 corr on

set oc *onoff*

set o2 corr *onoff*

onoff = | on | off |

These commands turn the oxygen correction (compensation) *on* or *off*. The following example turns the O₂ correction off.

Send: set oc off
Receive: set oc off ok

Hardware Configuration

contrast

This command reports the screen's level of contrast. The following example shows the screen contrast is 50%, according to [Table B-8](#).

Send: contrast
Receive: contrast 10:50%

set contrast *level*

This command sets the screen's *level* of contrast, according to [Table B-8](#). The following example sets the contrast level to 50%.

Send: set contrast 10
Receive: set contrast 10 ok

Table B-8. Contrast Levels

<i>Level</i>	Contrast Level
0	0%
1	5%
2	10%
3	15%
4	20%
5	25%
6	30%
7	35%
8	40%
9	45%
10	50%
11	55%
12	60%
13	65%
14	70%
15	75%
16	80%
17	85%
18	90%
19	95%
20	100%

date

This command reports the current date. The following example reports the date as December 1, 2009.

```
Send:      date
Receive:   date 12-01-09
```

set date *mm-dd-yy*
mm = month
dd = day
yy = year

This command sets the date of the analyzer's internal clock. The following example sets the date to December 1, 2009.

```
Send:      set date 12-01-09
Receive:   set date 12-01-09 ok
```

set default params

This command sets all the parameters to their default values. This does not affect the factory-calibrated parameters.

```
Send:      set default params
Receive:   set default params ok
```

save

set save params

This command stores all current parameters in FLASH memory. It is important that each time instrument parameters are changed, that this command be sent. If changes are not saved, they will be lost in the event of a power failure. The following example saves the parameters to FLASH memory.

```
Send:      set save params
Receive:   set save params ok
```

time

This command reports the current time (24-hour time). The following example reports that the internal time is 2:15:30 pm.

```
Send:      time
Receive:   time 14:15:30
```

set time *hh:mm:ss*

hh = hours

mm = minutes

ss = seconds

This command sets the internal clock (24-hour time). The following example sets the internal time to 2:15 pm.

Note If seconds are omitted, the seconds default to 00. ▲

```
Send:      set time 14:15
Receive:   set time 14:15 ok
```

Communications Configuration

addr dns

This command reports the TCP/IP address for the domain name server.

```
Send:      addr dns
Receive:   addr dns 192.168.1.1
```

set addr dns *address*

This command sets the domain name server *address*, where *address* consists of four numbers ranging from 0-255 inclusive, separated by “.”.

```
Send:          set addr dns 192.168.1.1
Receive:       set addr dns 192.168.1.1 ok
```

addr gw

This command reports the default TCP/IP gateway address.

```
Send:          addr gw
Receive:       addr gw 192.168.1.1
```

set addr gw *address*

This command sets the default gateway *address*, where *address* consists of four numbers ranging from 0-255 inclusive, separated by “.”.

Note This command cannot be used when DHCP is on. Refer to the DHCP command that follows for additional information. ▲

```
Send:          set addr gw 192.168.1.1
Receive:       set addr gw 192.168.1.1 ok
```

addr ip

This command reports the IP address of the analyzer.

```
Send:          addr ip
Receive:       addr ip 192.168.1.200
```

set addr ip *address*

This command sets the analyzer’s IP *address*, where *address* consists of four numbers ranging from 0-255 inclusive, separated by “.”.

Note This command cannot be used when DHCP is on. Refer to the DHCP command that follows for additional information. ▲

```
Send:          set addr ip 192.168.1.200
Receive:       set addr ip 192.168.1.200 ok
```

addr nm

This command reports the IP netmask.

```
Send:          addr nm
Receive:       addr nm 255.255.255.0
```

set addr nm *address*

This command sets the netmask *address*, where *address* consists of four numbers ranging from 0-255 inclusive, separated by “.”.

Note This command cannot be used when DHCP is on. Refer to the DHCP command that follows for additional information. ▲

```
Send:          set addr nm 255.255.255.0
Receive:       set addr nm 255.255.255.0 ok
```

addr ntp

This command reports the IP address for the network time protocol server. See “Network Time Protocol Server” in the Communications Settings” section of the “Operation” chapter for more information.

```
Send:          addr ntp
Receive:       addr ntp 10.209.43.237
```

set addr ntp *address*

This command sets the network time protocol server *address*, where *address* consists of four numbers ranging from 0-255 inclusive, separated by “.”.

```
Send:          set addr ntp 10.209.43.237
Receive:       set addr ntp 10.209.43.237 ok
```

baud

This command reports the current baud rate for the serial port (RS232/RS485). The following example reports that the current baud rate is 9600 baud.

```
Send:          baud
Receive:       baud 9600
```

set baud *rate*

rate = | 1200 | 2400 | 4800 | 9600 | 19200 | 38400 | 57600 | 115200 |

This command sets the instrument baud rate to *rate*. The following example sets the instrument’s baud rate to 9600.

Note After the command is sent, the baud rate of the sending device must be changed to agree with the instrument. ▲

```
Send:          set baud 9600
Receive:       set baud 9600 ok
```

dhcp

This command reports the current state of use of the Dynamic Host Configuration Protocol (DHCP) as on or off. DHCP is used to assign an IP address to the instrument automatically. The following example shows that DHCP is on.

```
Send:          dhcp
Receive:       dhcp on
```

set dhcp *onoff*

onoff = | on | off |

This command enables (*on*) and disables (*off*) the DHCP service. When DHCP is set to on, the instrument gets the IP address, the netmask address, and the gateway address from a DHCP server. When DHCP is set to off, the instrument gets these addresses from system memory. The following example sets the DHCP service to on.

Note If DHCP is changed from on to off and then the IP address, the netmask address, or the gateway address is changed, you must cycle power to the instrument before the change takes effect. Until you cycle the power, the address assigned by the DHCP server will still be used and reported as the current address. ▲

```
Send:          set dhcp on
Receive:       set dhcp on ok
```

format

This command reports the current reply termination format. The following example shows that the reply format is 00, which means reply with no checksum, according to [Table B-9](#).

```
Send:          format
Receive:       format 00
```

set format *format*

This command sets the reply termination *format*, where *format* is set according to [Table B-9](#). The following example sets the reply termination format to checksum.

```
Send:          set format 01
Receive:       set format 01 ok
```

Table B–9. Reply Termination Formats

<i>Format</i>	Reply Termination
00	<CR>
01	<NL> sum xxxx <CR>

where xxxx = 4 hexadecimal digits that represent the sum of all the characters (bytes) in the message

host name

This command reports the host name string. The following example reports the host name is set to *iSeries*. This command returns “bad cmd” if no host name has been set.

```
Send:          host name
Receive:       host name iSeries
```

set host name *string*

This command sets the host name *string*, where *string* is 1-13 alphanumeric characters (with no spaces). The following example sets the host name to *analyzer01*. This command returns “bad cmd” if no host name has been set.

```
Send:          set host name analyzer01
Receive:       set host name analyzer01 ok
```

instr name

This command reports the instrument name. The following example reports the instrument name for the Model 48*i*.

```
Send:          instr name
Receive:       instr name
               CO Analyzer
               CO Analyzer
```

instrument id

This command reports the instrument identification (ID). The following example reports the current setting of the instrument ID.

```
Send:          instrument id
Receive:       instrument id 48
```

set instrument id value

This command sets the instrument id to *value*, where *value* is an integer between 0 and 127 inclusive. The following example shows the instrument ID changed to 50.

Note Note sending this command via RS-232 or RS-485 will require the host to use the new id for subsequent commands. ▲

```
Send:          set instrument id 50
Receive:       set instrument id 50 ok
```

mode

This command reports what operating mode the instrument is in: local, service, or remote. The following example shows that the instrument is in the remote mode.

```
Send:          mode
Receive:       mode remote
```

set mode local

set mode remote

These commands set the instrument to local or remote mode. The following example sets the instrument to the local mode.

```
Send:          set mode local
Receive:       set mode local ok
```

allow mode cmd

This command reports the current allow mode setting: 1 = allow “set mode local” and “set mode remote” commands; 0 = ignore “set mode local” or “set mode remote” commands, according to [Table B-10](#). The default value is 0; ignore the commands. The following example shows that the instrument is configured to ignore “set mode local” or “set mode remote” commands.

```
Send:          allow mode cmd
Receive:       allow mode cmd 0
```

set allow mode cmd *value*

This command is used to configure the instrument to *value*, where *value* is either 1 = accept or 0 = ignore the “set mode local” and “set mode remote” commands, according to [Table B-10](#).

If the instrument is set to accept the commands (*value* = 1), the “set mode local” command will unlock the instrument and the keypad can be used to make changes via the front panel.

If the instrument is set to ignore the commands (*value* = 0), the instrument will respond with “ok” as if the command has been accepted and acted

upon, but it will not change the instrument lock status (this is for compatibility with systems expecting and “ok” response).

Note The instrument will always respond to the command “mode” with the status of the password lock as “mode local” or “mode remote”, regardless of the above setting. ▲

The following example sets the instrument to accept the “set mode local” and “set mode remote” commands.

```
Send:          set allow mode cmd 1
Receive:       set allow mode cmd 1 ok
```

Table B–10. Allow Mode Command Values

<i>Value</i>	Allow Mode Command
0	Ignore (default)
1	Accept

power up mode

This command reports the current power up mode setting to either 0 = local/unlocked or 1 = remote/locked, according to [Table B–11](#). The default value is 0; power up in local/unlocked mode. The following example shows that the instrument is configured to power up in the remote/locked mode.

```
Send:          power up mode
Receive:       power up mode 1
```

set power up mode *value*

This command is used to configure the instrument to power up in the local/unlocked mode (*value* = 0) or the remote/locked mode (*value* = 1), according to [Table B–11](#).

If the instrument is set to power up in the local/remote mode, the keypad can be used to make changes via the front panel. If the instrument is set to power up in the remote/locked mode, changes can not be made from the front panel. The following example sets the instrument to power up in remote/locked mode.

```
Send:          set power up mode 1
Receive:       set power up mode 1 ok
```

Table B–11. Power Up Mode Values

<i>Value</i>	Power up Mode
0	Local/Unlocked Mode (default)
1	Remote/Locked Mode

program no

This command reports the analyzer’s model information and program version number.

Send: program no
Receive: program no iSeries 48i 01.02.12.095

set layout ack

This command reports the stale layout/layout change indicator (*) that is attached to each response if the erec layout has changed since the last time erec layout was requested, according to [Table B–12](#). The following example reports that the instrument is configured to do nothing.

Send: layout ack
Receive: layout ack 0

set layout ack *value*

This command disables the stale layout/layout change indicator (*) that is attached to each response if the erec layout has changed since the last time erec layout was requested, according to [Table B–12](#).

Send: set layout ack
Receive: set layout ack ok

Table B–12. Set Layout Ack Values

<i>Value</i>	Function
0	Do nothing (default)
1	Append “*”

tz

This command reports the “tz” timezone string for the NTP server. See “Network Time Protocol Server” in the “Communications Settings” section of the “Operation” chapter for more information.

Send: tz
Receive: tz EST+5EDT

set tz *string*

This command sets the timezone *string* for the instrument for use with the NTP server, where *string* is a standard timezone string. Common strings are listed in the “Timezone” screen description in Chapter 3.

Send: set tz EST+5EDT
Receive: set tz EST+5EDT ok

I/O Configuration

analog iout range *channel*

This command reports the analog current output range setting for *channel*, where *channel* must be between 1 and 6, inclusive. The following example reports current output channel 4 is in the 4-20 mA range, according to [Table B-13](#). This command responds with “feature not enabled” if the I/O expansion board is not detected.

Send: analog iout range 4
Receive: analog iout range 4 2

set analog iout range *channel range*

This command sets analog current output *channel* to the *range* where *channel* is between 1 and 6 inclusive, and *range* is set according to [Table B-13](#). The following example sets current output channel 4 to the 0-20 mA range. This command responds with “feature not enabled” if the I/O expansion board is not detected.

Send: set analog iout range 4 1
Receive: set analog iout range 4 1 ok

Table B-13. Analog Current Output Range Values

<i>Range</i>	Output Range
1	0-20 mA
2	4-20 mA
0 [cannot be set to this, but may report]	Undefined

analog vin *channel*

This command retrieves the analog voltage input *channel* data, both the calculated value and the actual voltage. In the following example, the “calculated” value of channel 1 is 75.325 degrees F, volts are 2.796. This command responds with “feature not enabled” if the I/O expansion board is not detected.

Send: analog vin 1
Receive: analog vin 1 75.325 2.796

analog vout range *channel*

This command reports the analog voltage output *channel* range, where *channel* is between 1 and 6 inclusive, according to [Table B-14](#). The following example reports that analog voltage output channel 2 is set to 3 (1-10 V).

```
Send:          analog vout range 2
Receive:       analog vout range 2 3
```

set analog vout range *channel range*

This command sets analog voltage output *channel* to the range, where *channel* is between 1 and 6 inclusive, and *range* is set according to [Table B-14](#). The following example sets channel 2 to the 0-10 V range.

```
Send:          set analog vout range 2 3
Receive:       set analog vout range 2 3 ok
```

Table B-14. Analog Voltage Output Range Values

<i>Range</i>	Output Range
1	0-1 V
2	0-100 mV
3	0-10 V
4	0-5 V
0 [cannot be set to this, but may report]	Undefined

mb read coils *start count*

start = index of first coil, *count* = number of coils to report

This command reports the current state of the MODBUS coils (digital outputs). Output is in binary format with the coil *start* appearing as the right-most bit.

```
Send:          mb read coils 1 15
Receive:       mb read coils 1 15 000000100000001
```

mb read registers *start count*

start = index of first register (must be odd number), *count* = number of registers to report (must be even), each pair of registers is reported as a float.

This command reports the current state of the MODBUS registers (analog outputs). Output is in floating point format with the pair of registers *start* and *start+1* appearing as the left-most value.

```
Send:          mb read registers 5 4
Receive:       mb read registers 5 4 552629 000000 55998800.000000
```

set mb write coil *coil state*

coil = index of coil to be set, *state* = 1 or 0

This command sets the current state of the MODBUS coil *coil* (digital input). *coil* has an offset of 100 (that is, the first write coil is address 101).

```
Send:          set mb write coil 104 1
Receive:       set mb write coil 104 1 ok
```

dig in

This command reports the status of the digital inputs as a 4-digit hexadecimal string with the most significant bit (MSB) being input 16.

```
Send:          dig in
Receive:       dig in 0xff7f
```

din *channel*

This command reports the action assigned to the digital input *channel* and the index number of the corresponding active state. The following example reports input 5 to be assigned an index number 9 corresponding to action of “analog outputs to zero” with the active state being high.

```
Send:          din 5
Receive:       din 5 9 AOUTS TO ZERO high
```

set din *channel index state*

This command assigns digital input *channel* (1-16) to activate the action indicated by *index* (1-12), when the input transitions to the designated *state* (high or low). Use the “list var din” command to obtain the list of supported *index* values and corresponding actions. The following example sets the digital input channel 1 to 3 on a low-to-high transition.

```
Send:          set din 1 3 high
Receive:       set din 1 3 high ok
```

dout *channel*

This command reports the index number, output variable and the active state assigned to digital output *channel*. The following example reports output 4 to be assigned an index number 11 corresponding to action of “general alarm”.

```
Send:          dout 4
Receive:       dout 4 11 GEN ALARM open
```

set dout *channel index state*

This command assigns digital output *channel* (1-10) to be assigned to the action associated with *index* (1-34), and assigns it an active state of *state* (open or closed). Use the “list var dout” command to obtain the list of supported index values and corresponding state. The following example sets the digital output channel 4 to state 11.

```
Send:          set dout 4 11 open
Receive:       set dout 4 11 open ok
```

dtoa *channel*

This command reports the outputs of the 6 or 12 Digital to Analog converters, according to [Table B–15](#). The following example shows that the D/A #1 is 97.7% full-scale.

```
Send:          dtoa 1
Receive:       dtoa 1 97.7%
```

Note If the instrument is in a mode which does not provide a particular output, and that output is selected, the value will be 0.0. ▲

Note All channel ranges are user definable. If any customization has been made to the analog output configuration, the default selections may not apply. ▲

Table B–15. Default Analog Output Channel Assignments

D to A	Function	Single Range	Dual Range	Auto Range
1	Voltage Output	CO	Low CO	CO
2	Voltage Output	CO	High CO	Range Status
3	Voltage Output	Not Used	Not Used	Not Used
4	Voltage Output	Not Used	Not Used	Not Used
5	Voltage Output	Not Used	Not Used	Not Used
6	Voltage Output	Not Used	Not Used	Not Used
7	Current Output	CO	Low CO	CO
8	Current Output	CO	High CO	Range Status
9	Current Output	Not Used	Not Used	Not Used
10	Current Output	Not Used	Not Used	Not Used
11	Current Output	Not Used	Not Used	Not Used
12	Current Output	Not Used	Not Used	Not Used

list din

list dout

These commands report the current selection for the digital inputs or the digital outputs in the format. Output no Index number variable name active state. The active state for digital outputs is open or closed. The active state for digital inputs is high or low. Channels that have not been assigned a variable index are not displayed.

```
Send:          list dout
Receive:       list dout
               output index variable state
               1 22 I/O BD COMM closed
               2 2 LOCAL/REMOTE open
               3 4 UNITS open
               4 19 BIAS VOLTAGE closed
               7 7 SAMPLE MODE open
               8 8 GEN MODE open
```

list var aout

list var dout

list var din

These commands report the list of index numbers, and the variables (associated with that index number) available for selection in the current mode for analog outputs, digital outputs, and digital inputs. The index number is used to insert the variable in a field location in a list using “set sp *field index*”. The following example reports the list of analog outputs, index numbers, and variables.

```
Send:          list var aout
Receive:       list var aout
               index variable
               0 none
               1 CO
               5 sr
               8 intt
               9 cht
               10 aux
               13 pres
               14 smpfl
               15 intensity
               16 speed
               28 biasv
```

relay stat

This command reports the current relay logic as normally “open” or normally “closed,” if all the relays are set to same state, that is all open or all closed. The following example shows that the status of all the relays’ logic is set to normally “open”.

Send: relay stat
Receive: relay stat open

Note If individual relays have been assigned different logic, then the response would be a 4-digit hexadecimal string with the least significant byte (LSB) being relay no 1. ▲

For example:

Receive: relay stat 0x0001 (indicates relay no 1 is set to normally open logic, all others are normally closed)
Receive: relay stat 0x0005 (indicates relay no 1 and 3 are set to be normally open logic, all others are normally closed)

set relay open
set relay open *value*
set relay closed
set relay closed *value*

These commands set the relay logic to normally open or closed for relay number *value*, where *value* is the relay between 1 and 16. The following example sets the relay no 1 logic to normally open.

Note If the command is sent without an appended relay number, then all the relays are assigned the set logic of normally open/closed. ▲

Send: set relay open 1
Receive: set relay open 1 ok

Record Layout Definition

The erc, lrec, and srec layouts contain the following:

- A format specifier for parsing ASCII responses
- A format specifier for parsing binary responses

In addition to these, the erc layout contains:

- A format specifier for producing the front panel display screens

Values are read using either the ASCII or binary format specifiers and converted to uniform internal representations (32-bit floats or 32-bit integers). These values are converted into text for display on the screen using the format specifier for the front panel display. Normally, the specifier used to parse a particular datum from the input stream will be strongly related to the specifier used to display it (such as, all of the floating point inputs will be displayed with an 'f' output specifier, and all of the integer inputs will be displayed with a 'd' specifier).

Format Specifier for ASCII Responses

The first line of the layout response is the scanf-like parameter list for parsing the fields from an ASCII erc response. Parameters are separated by spaces and the line is terminated by a “\n” (the normal line separator character). Valid fields are:

- %s - parse a string
- %d - parse a decimal number
- %ld - parse a long (32-bit) decimal number
- %f - parse a floating point number
- %x - parse a hexadecimal number
- %lx - parse a long (32-bit) hex number
- %* - ignore the field

Note Signed versus unsigned for the integer values does not matter; it is handled automatically. ▲

Format Specifier for Binary Responses

The second line of the layout response is the binary parameter list for parsing the fields from a binary response. Parameters MUST be separated by spaces, and the line is terminated by a '\n'. Valid fields are:

- t - parse a time specifier (2 bytes)
- D - parse a date specifier (3 bytes)
- i - ignore one 8-bit character (1 byte)
- e - parse a 24-bit floating point number (3 bytes: n/x)
- E - parse a 24-bit floating point number (3 bytes: N/x)
- f - parse a 32-bit floating point number (4 bytes)

- c - parse an 8-bit signed number (1 byte)
- C - parse an 8-bit unsigned number (1 byte)
- n - parse a 16-bit signed number (2 bytes)
- N - parse a 16-bit unsigned number (2 bytes)
- m - parse a 24-bit signed number (3 bytes)
- M - parse a 24-bit unsigned number (3 bytes)
- l - parse a 32-bit signed number (4 bytes)
- L - parse a 32-bit unsigned number (4 bytes)

There is an optional single digit *d* which may follow any of the numeric fields, which indicates that after the field has been parsed out, the resulting value is to be divided by 10^d . Thus the 16-bit field 0xFFC6 would be interpreted with the format specifier 'n3' as the number -0.058.

Format Specifier for Erc Layout

The subsequent lines in the erc layout response describe the appearance of the full panel. The full instrument panel as it appears on the screen has two

columns of lines. Each line is composed of three major components: (1) a text field, (2) a value field, and (3) a button. None of these three components is required. The text field contains statically displayed text.

The value field displays values which are parsed out of the response to a `erec` command. It also displays, though background changes, alarm status. The button, when pressed, triggers input from either a dialog box or a selection list. There are five kinds of buttons, B, I, L, T, and N.

Each line in the layout string corresponds to one line on the display. The layout string describes each of the three major fields as well as translation mechanisms and corresponding commands.

Text The first field in the layout string is the text. It is delimited by a ':'. The string up to the first ':' will be read and inserted in the text field of the line.

Value String This is followed by a possible string enclosed in quotes that is used to place a string into the value field.

Value Source The value source, which is the item (or word) number in the DATA/EREC response, appears next. This is followed by an optional bitfield designator. The datum identified by the value source can be printed as a string 's', hexadecimal 'x', decimal 'd', floating point 'f', or binary 'b' number. Typically, bitfield extractions are only done for decimal or hexadecimal numbers.

Floating-point numbers can be followed with an optional precision specifier which will be used as an argument to `printf`'s `%f` format (for example, a field of '4' would be translated into the `printf` command of `%.3f`). Alternately, the special character '*' can precede the precision specifier; this causes an indirection on the precision specifier (which now becomes a field number).

This is useful when formatting, for example, numbers which have varying precision depending on the mode of the instrument.

Binary numbers can also have an optional precision specifier which is used to determine how many bits to print. For example, the specifier 'b4' will print the lowest four bits of the parsed number.

There are serious restrictions on where an 's' field may appear: currently sources 1 and 2 must be 's', and no others may be 's'.

Alarm Information The value source is followed by optional alarm information, indicated by a commercial at sign '@' with a source indicator and a starting bit indicator.

All alarm information is presumed to be two bits long (low and high). The bitfield extraction is performed on the integer part of the source. Typical alarm information would appear as '@6.4'.

Translation Table Then, there appears an optional translation table within braces '{}'. This is a string of words separated by spaces. An example translation table would be '{Code_0 Code_1 Code_2 Code_3}'. The value, once extracted, is used as a zero-based index into the translation table to determine the string to display.

Selection Table Then there appears an optional selection table within parentheses '(...)'. This is a string of numbers separated by spaces '(0 1)'. The selection table lists the translation table entries which the user may select from when setting the parameter. This is not necessarily the same as the entries which may be displayed.

Button Designator Then there appears an optional button designator. This will be one of 'B', 'I', 'L', 'T', or 'N'.

B- Indicates a button which pops up an input dialog prompting the user for a new value using the designated input format. The input format is specified from the 'B' through the subsequent semicolon.

I—Indicates a button which pops up a selection list with input translation. That is, the values read are translated before they are compared to the selection list options.

L—Indicates a button which pops up a selection list without any translation. The output value is the number of the selected option.

T—Indicates a button which pops up a selection list with output translation. The number of the option selected is used as an index into the translation table to generate an output string.

N—Indicates a button which only sends the subsequent command to the instrument. No user-prompting happens.

The following string through an optional '[' or the end of the line is the command which is to be sent to the instrument upon the completion of the button selection. The command string should normally contain print-style formatting to include the user input. If a '[' is present, it indicates a command which is sent to the instrument upon successful completion of the button command to update the value field.

Examples Some examples ('\n' is the C syntax for an end-of-line character):

```
'Concentrations\n'
```

This is a single text-only line.

```
'\n'
```

This is a single blank line.

```
' NO:3s\n'
```

This is a line which appears slightly indented. The text field is 'NO', the value is taken from the third element of the data response, and interpreted as a string.

```
' NO:18sBd.ddd;set no coef %s\n'
```

This is a line which also appears slightly indented. The next field is also 'NO', but the value is taken from the eighteenth element of the data response, again interpreted as a string. A button appears on this line which, when pressed, pops up an input dialog which will state "Please enter a new value for NO using a d.ddd format." The string entered by the user is used to construct the output command. If the user enters, for example, '1.234', the constructed command will be 'set no coef 1.234'.

```
' NO:21f{Code_0 Code_1 Code_2 Code_3 Code_4 Code_5 Code_6  
Code_7 Code_8 Code_9 Code_10 Code_11}Lset range no %d\n'
```

This is a line which appears slightly indented, the title is again 'NO', and the value is the twenty-first element of the data response, interpreted as a floating-point number. There is a no-translation button which creates a selection list of twelve "Code nn" options. The number of the user selection is used to create the output command.

```
'Mode:6.12-13x{local remote service service}(0 1)Tset mode  
%s\n'
```

This is a line which has a title of 'Mode' and value taken from the sixth field of the data response. There is a bitfield extraction of bits 12 through 13 from the source (the value type is not important here because the value is being translated to an output string). Once the bits have been extracted, they are shifted down to the bit-zero position. Thus, the possible values of this example will be 0 through 3. The translation list shows the words which correspond to each input value, the zero index value appearing first (0 -> local, 1 -> remote, etc.). The selection list shows that only the first two values, in this case, are to be shown to the user when the button is

pressed. The 'T' button indicates full translation, input code to string, and user selection number to output string.

```
'\xC'
```

This is a line that starts a new column (the \xC or ^L).

```
' Comp:6.11x{off on}Tset temp comp %s\n'
```

This shows that the bitfield end (the second part of a bitfield specification) is optional. The bitfield will be one bit long, starting in this case at the eleventh bit.

```
'Background:7f*8Bd.ddd;set o3 bkg %s\n'
```

This shows the use of indirect precision specifiers for floating point displays. The background value is taken from the 7th element, and the precision specifier is taken from the 8th. If the asterisk were not present, it would indicate instead that 8 digits after the decimal point should be displayed.

Appendix C

MODBUS Protocol

This appendix provides a description of the MODBUS Protocol Interface and is supported both over RS-232/485 (RTU protocol) as well as TCP/IP over Ethernet.

The MODBUS commands that are implemented are explained in detail in this document. The MODBUS protocol support for the *iSeries* enables the user to perform the functions of reading the various concentrations and other measurement values, read the status of the digital outputs of the analyzer, and to trigger or simulate the activation of a digital input to the instrument. This is achieved by using the supported MODBUS parameters listed below.

For details of the Model 48*i* MODBUS Protocol specification, see the following topics:

- “Serial Communication Parameters” on page C-1
- “TCP Communication Parameters” on page C-2
- “Application Data Unit Definition” on page C-2
- “Function Codes” on page C-3
- “MODBUS Parameters Supported” on page C-8

Additional information on the MODBUS protocol can be obtained at <http://www.modbus.org>. References are from MODBUS Application Protocol Specification V1.1a MODBUS-IDA June 4, 2004.

Serial Communication Parameters

The following are the communication parameters that are used to configure the serial port of the *iSeries* to support MODBUS RTU protocol.

Number of Data bits	: 7 or 8
Number of Stop bits	: 1 or 2
Parity	: None, Odd, or Even
Data rate	: 1200 to 115200 Baud (9600 is default)

TCP Communication Parameters

*i*Series instruments support the MODBUS/TCP protocol. The register definition is the same as for the serial interface. Up to three simultaneous connections are supported over Ethernet.

TCP connection port for MODBUS : 502

Application Data Unit Definition

Here are the MODBUS ADU (Application Data Unit) formats over serial and TCP/IP:

Serial:	Slave Address	Function Code	Data	Error Check
TCP/IP:	MBAP Header	Function Code	Data	

Slave Address

The MODBUS slave address is a single byte in length. This is the same as the instrument ID used for C-Link commands and can be between 1 and 127 decimal (i.e. 0x01 hex to 0x7F hex). This address is only used for MODBUS RTU over serial connections.

Note Device ID '0', used for broadcast MODBUS commands, is not supported. Device IDs 128 through 247 (i.e. 0x80 hex to 0xF7 hex) are not supported because of limitations imposed by C-Link. ▲

MBAP Header

In MODBUS over TCP/IP, a MODBUS Application Protocol Header (MBAP) is used to identify the message. This header consists of the following components:

Transaction Identifier	2 Bytes	0x0000 to 0xFFFF (Passed back in response)
Protocol Identifier	2 Bytes	0x00 (MODBUS protocol)
Length	2 Bytes	0x0000 to 0xFFFF (Number of following bytes)
Unit Identifier	1 Byte	0x00 to 0xFF (Passed back in response)

A slave address is not required in MODBUS over TCP/IP because the higher-level protocols include device addressing. The unit identifier is not used by the instrument.

Function Code

The function code is a single byte in length. The following function codes are supported by the instrument:

Read Coils	:	0x01
Read Inputs	:	0x02
Read Holding Registers	:	0x03
Read Input Registers	:	0x04
Force (Write) Single Coil	:	0x05
Read Exception Status	:	0x06

If a function code is received that is not in this list, an invalid function exception is returned.

Data

The data field varies depending on the function. For more description of these data fields, see “Function Codes” below.

Error Check

In MODBUS over serial, an error check is included in the message. This is not necessary in MODBUS over TCP/IP because the higher-level protocols ensure error-free transmission. The error check is a two-byte (16 bit) CRC value.

Function Codes

This section describes the various function codes that are supported by the Model 48*i*.

(0x01/0x02) Read Coils/Read Inputs

Read Coils/Inputs read the status of the digital outputs (relays) in the instrument. Issuing either of these function codes will generate the same response.

These requests specify the starting address, i.e. the address of the first output specified, and the number of outputs. The outputs are addressed starting at zero. Therefore, outputs numbered 1–16 are addressed as 0–15.

The outputs in the response message are packed as one per bit of the data field. Status is indicated as 1 = Active (on) and 0 = Inactive (off). The LSB of the first data byte contains the output addressed in the query. The other outputs follow toward the high end of this byte, and from low order to high order in subsequent bytes. If the returned output quantity is not a multiple of eight, the remaining bits in the final data byte will be padded with zeros (toward the high order end of the byte). The Byte Count field specifies the quantity of complete bytes of data.

Note The values reported may not reflect the state of the actual relays in the instrument, as the user may program these outputs for either active closed or open. ▲

Request

Function Code	1 Byte	0x01 or 0x02
Starting Address	2 Bytes	0x0000 to maximum allowed by instrument
Quantity of Outputs	2 Bytes	1 to maximum allowed by instrument
Unit Identifier	1 Byte	0x00 to 0xFF (Passed back in response)

Response

Function Code	1 Byte	0x01 or 0x02
Byte Count	1 Byte	N*
Output Status	N Byte	N = N or N+1

*N = Quantity of Outputs / 8, if the remainder not equal to zero, then N=N+1

Error Response

Function Code	1 Byte	0x01 or 0x02
Exception Code	1 Byte	01=Illegal Function, 02=Illegal Address, 03=Illegal Data, 04=Slave Device Failure

Here is an example of a request and response to read outputs 2–15:

Request

<i>Field Name</i>	<i>(Hex)</i>
Function	0x01
Starting Address Hi	0x00
Starting Address Lo	0x02
Quantity of Outputs Hi	0x00
Quantity of Outputs Lo	0x0D

Response

<i>Field Name</i>	<i>(Hex)</i>
Function	0x01
Byte Count	0x03
Output Status 2–10	0xCD
Output Status 11–15	0x0A

The status of outputs 2–10 is shown as the byte value 0xCD, or binary 1100 1101. Output 10 is the MSB of this byte, and output 2 is the LSB. By convention, bits within a byte are shown with the MSB to the left and the LSB to the right. Thus, the outputs in the first byte are '10 through 2', from left to right. In the last data byte, the status of outputs 15-11 is shown as the byte value 0x0A, or binary 0000 1010. Output 15 is in the fifth bit position from the left, and output 11 is the LSB of this byte. The four remaining high order bits are zero filled.

(0x03/0x04) Read Holding Registers/Read Input Registers

Read Holding/Input Registers reads the measurement data from the instrument. Issuing either of these function codes will generate the same response. These functions read the contents of one or more contiguous registers.

These registers are 16 bits each and are organized as shown below. All of the values are reported as 32-bit IEEE standard 754 floating point format. This uses 2 sequential registers, least significant 16 bits first.

The request specifies the starting register address and the number of registers. Registers are addressed starting at zero. Therefore, registers numbered 1–16 are addressed as 0–15. The register data in the response message are packed as two bytes per register, with the binary contents right justified within each byte. For each register, the first byte contains the high order bits and the second contains the low order bits.

Request

Function Code	1 Byte	0x03 or 0x04
Starting Address	2 Bytes	0x0000 to maximum allowed by instrument
Quantity of Registers	2 Bytes	1 to maximum allowed by instrument

Response

Function Code	1 Byte	0x03 or 0x04
Byte Count	1 Byte	2 x N*
Register Value	N* x 2 Bytes	N = N or N+1

*N = Quantity of Registers

Error Response

Function Code	1 Byte	Function code + 0x80
Exception Code	1 Byte	01=Illegal Function, 02=Illegal Address, 03=Illegal Data, 04=Slave Device Failure

Here is an example of a request and response to read registers 10–13:

Request

<i>Field Name</i>	<i>(Hex)</i>
Function	0x03
Starting Address Hi	0x00
Starting Address Lo	0x09
No. of Registers Hi	0x00
No. of Registers Lo	0x04

Response

<i>Field Name</i>	<i>(Hex)</i>
Function	0x03
Byte Count	0x06
Register Value Hi (10)	0x02
Register Value Lo (10)	0x2B
Register Value Hi (11)	0x00
Register Value Lo (11)	0x00

Register Value Hi (12)	0x00
Register Value Lo (12)	0x64
Register Value Hi (13)	0x00
Register Value Lo (13)	0x64

The contents of register 10 are shown as the two byte values of 0x02 0x2B. Then contents of registers 11–13 are 0x00 0x00, 0x00 0x64 and 0x00 0x64, respectively.

(0x05) Force (Write) Single Coil

The Force (Write) Single Coil function simulates the activation of the digital inputs in the instrument, which triggers the respective action.

This function code is used to set a single action to either ON or OFF. The request specifies the address of the action to be forced. Actions are addressed starting at zero. Therefore, action number 1 is addressed as 0. The requested ON/OFF state is specified by a constant in the request data field. A value of 0xFF00 requests the action to be ON. A value of 0x0000 requests it to be OFF. All other values are illegal and will not affect the output. The normal response is an echo of the request, returned after the state has been written.

Note This function will not work if the instrument is in service mode. ▲

Request

Function Code	1 Byte	0x05
Starting Address	2 Bytes	0x0000 to maximum allowed by instrument
Output Value	2 Bytes	0x0000 or 0xFF00

Response

Function Code	1 Byte	0x05
Starting Address	2 Bytes	0x0000 to maximum allowed by instrument
Output Value	2 Bytes	0x0000 or 0xFF00

Error Response

Function Code	1 Byte	Function code + 0x80
Exception Code	1 Byte	01=Illegal Function, 02=Illegal Address, 03=Illegal Data, 04=Slave Device Failure

Here is an example of a request to write Coil 5 ON:

Request

<i>Field Name</i>	<i>(Hex)</i>
Function	05
Output Address Hi	00
Output Address Lo	05
Output Value Hi	FF
Output Value Lo	00

Response

<i>Field Name</i>	<i>(Hex)</i>
Function	05
Output Address Hi	00
Output Address Lo	05
Output Value Hi	FF
Output Value Lo	00

MODBUS Parameters Supported

Table C-1 through Table C-3 lists the MODBUS addresses supported for the Model 48i.

IMPORTANT NOTE The addresses in the following tables are Protocol Data Unit (PDU) addresses. Verify the coil number on your MODBUS master to ensure that it matches the coil number on the instrument. ▲

Note Coil status 1 indicates active state. ▲

Table C-1. Read Coils for 48i

Coil Number	Status
0	NONE
1	AUTO RANGE
2	LOCAL/REMOTE
3	SERVICE
4	UNITS
5	ZERO MODE

Coil Number	Status
6	SPAN MODE
7	SAMPLE MODE
8	GEN ALARM
9	CONC MAX ALARM
10	CONC MIN ALARM
11	INTERNAL TEMP ALARM
12	BENCH TEMP ALARM
13	PRESSURE ALARM
14	SAMPLE FLOW ALARM
15	INTENSITY ALARM
16	MOTOR SPEED ALARM
17	BIAS VOLTAGE ALARM
18	MB STATUS ALARM
19	INTERFACE BD STATUS ALARM
20	I/O EXP BD STATUS ALARM
21	CONC ALARM
22	PURGE MODE
23	NOT USED
24	ZERO CHK/CAL ALARM
25	SPAN CHK/CAL ALARM
26	NOT USED
27	NOT USED
28	NOT USED
29	NOT USED
30	NOT USED
31	NOT USED
32	NOT USED
33	NOT USED
34	EXT ALARM 1
35	EXT ALARM 2
36	EXT ALARM 3

In addition to the coils listed in the Read Coils table, coils in the Write Coils table can also be read.

IMPORTANT NOTE The addresses in the following tables are Protocol Data Unit (PDU) addresses. Verify the register number on your MODBUS master to ensure that it matches the register number on the instrument. ▲

Note For additional information on how to read registers and interpret the data, refer to the “(0x03/0x04) Read Holding Registers/Read Input Registers” section in this appendix. ▲

Table C–2. Read Registers for 48*i*

Register Number	Variable
0	NONE
1&2	CO
3&4	LO CO
5&6	HI CO
7&8	RANGE STATUS
9&10	S/R
11&12	LO S/R
13&14	HI S/R
15&16	INT TEMP
17&18	BENCH TEMP
19&20	NOT USED
21&22	NOT USED
23&24	NOT USED
25&26	PRESSURE
27&28	SAMPLE FLOW
29&30	INTENSITY
31&32	MOTOR SPEED
33&34	ANALOG IN 1
35&36	ANALOG IN 2
37&38	ANALOG IN 3
39&40	ANALOG IN 4
41&42	ANALOG IN 5
43&44	ANALOG IN 6
45&46	ANALOG IN 7
47&48	ANALOG IN 8

Register Number	Variable
49&50	NOT USED
51&52	NOT USED
53&54	NOT USED
55&56	BIAS SUPPLY
57&58	NOT USED
59&60	NOT USED
61&62	NOT USED
63&64	NOT USED
65&66	NOT USED
67&68	EXT ALARMS
69&70	O2 %*
71&72	O2 SENS TEMP*
73&74	NOT USED
75&76	NOT USED
77&78	NOT USED
79&80	CO COR*
81&82	LO CO COR*
83&84	HI CO COR*
85&86	NOT USED
87&88	NOT USED
89&90	NOT USED

*If internal O2 Sensor is installed

IMPORTANT NOTE The addresses in the following tables are Protocol Data Unit (PDU) addresses. Verify the coil number on your MODBUS master to ensure that it matches the coil number on the instrument. ▲

Note Writing 1 to the coil number shown in the following table will initiate the “action triggered” listed in the table. This state must be held for at least 1 second to ensure the instrument detects the change and triggers the appropriate action. ▲

Note The coils within each coil group in the following table are mutually exclusive and will not be triggered if there is conflict. Before you assert (1) one coil in a group, make sure the other coils in the group are de-asserted (0). ▲

Table C-3. Write Coils for 48i

Coil Number	Action
100	NONE
101	ZERO MODE
102	SPAN MODE
103	SET BACKGROUND
104	CAL TO LOW SPAN
105	AOUTS TO ZERO
106	AOUTS TO FS
107	CAL TO HIGH SPAN
108	NOT USED
109	NOT USED
110	NOT USED
111	ZERO/PURGE CAL
112	SPAN/PURGE CAL
113	ZERO/SPAN/PURGE
114	EXT ALARM 1
115	EXT ALARM 2
116	EXT ALARM 3
117	PURGE MODE

In addition to the coils listed in the Write Coils table, coils in the Read Coils table can also be read.

Reading a Write Coil

To read a write coil, issue a read coil command for that coil. For example, to view the state of write coil 101, issue a “read coil 101”.

Appendix D

Gesytec (Bayern-Hessen) Protocol

This appendix provides a description of the Gesytec (Bayern-Hessen or BH) Protocol Interface and is supported both over RS-232/485 as well as TCP/IP over Ethernet.

The Gesytec commands that are implemented are explained in detail in this document. The Gesytec protocol support for the *i*Series enables the user to perform the functions of reading the various concentrations and to trigger the instrument to be in sample/zero/span mode if valid for that instrument. This is achieved by using the supported Gesytec commands listed below.

For details of the Model 48*i* Gesytec Protocol specification, see the following topics:

- “Serial Communication Parameters” on page D-1
- “TCP Communication Parameters” on page D-2
- “Instrument Address” on page D-2
- “Abbreviations Used” on page D-2
- “Basic Command Structure” on page D-2
- “Block Checksum Characters <BCC>” on page D-3
- “Gesytec Commands” on page D-3

Serial Communication Parameters

The following are the communication parameters that are used to configure the serial port of the *i*Series to support Gesytec protocol.

Number of Data bits	: 7 or 8
Number of Stop bits	: 1 or 2
Parity	: None, Odd, or Even
Data rate	: 1200 to 115200 Baud (9600 is default)

TCP Communication Parameters

iSeries instruments support the Gesytec protocol over TCP/IP. The register definition is the same as for the serial interface. Up to three simultaneous connections are supported over Ethernet.

TCP connection port for Gesytec: 9882

Instrument Address

The Gesytec instrument address has a value between 0 and 127 and is represented by a 3 digit ASCII number with leading zeros or leading spaces if required (e.g. instrument address of 1 is represented as 001 or <SP><SP>1).

The instrument address is the same as the Instrument ID used for C-Link and MODBUS commands. This can be set via the front panel.

The instrument address is represented by <address> in the examples throughout this document.

Note Device IDs 128 through 247 are not supported because of limitations imposed by the C-Link protocol. ▲

Abbreviations Used

The following is a list of abbreviations used in this document:

<CR> is abbreviation for Carriage Return (ASCII code 0x0D)

<STX> is abbreviation for Start of Text (ASCII code 0x02)

<ETX> is abbreviation for End of Text (ASCII code 0x03)

<SP> is abbreviation for space (ASCII code 0x20)

Basic Command Structure

The following is the basic structure of a Gesytec command:

<STX>Command text<ETX><BCC>

OR

<STX>Command text<CR>

Each command is framed by control characters, <STX> at the start and terminated with either <ETX> or <CR>.

If a command is terminated with <ETX>, then two additional characters <BCC> is attached after <ETX>. This is the block checksum.

Block Checksum Characters <BCC> may be added to the command to prevent processing invalid commands.

Block Checksum Characters <BCC>

The Block Checksum Characters are calculated beginning with a seed value of 00000000, binary (0x00), and bitwise exclusive ORing with each of the characters of the command string (or response) including the framing characters <STX> and <ETX>. The checksum works as an error check. The command terminator determines the presence or absence of <BCC>.

If a command is terminated by <ETX> then the next two characters are the checksum, if the command is terminated with <CR> no checksum is attached.

The block checksum is represented by two characters, which represent a 2 digit hex number (1byte) (e.g. 1 byte 0xAB hex checksum will be represented by the two characters 'A' & 'B').

The checksum is referred to as <BCC> throughout this document.

Gesytec Commands

The following commands are supported by the Gesytec protocol:

- Instrument Control Command (ST)
- Data Sampling/Data Query Command (DA)

Instrument Control Command (ST)

There are three control commands supported by the Gesytec protocol.

This <control command> is a single letter, which triggers an action in the instrument. These commands are active only when service mode is inactive and the zero/span option is present.

Command 'N' switches the instrument gas mode to Zero mode.

Command 'K' switches the instrument gas mode to Span mode.

Command 'M' switches the instrument gas mode to Sample mode.

The following are the different acceptable formats of the ST command:

<STX>ST<address><control command><ETX><BCC>

OR

<STX>ST<address><control command><CR>

OR

<STX>ST<address><SP><control command><CR>

OR

<STX>ST<address><SP><control command><ETX><BCC>

The <address> is optional, which means it can be left out completely. The <address>, if present, must match the Instrument Address. Additional space can be present after the <address>.

If the received command does not satisfy the above formats, or if the <address> does not match the Instrument Address, the command is ignored.

This is a sample command to switch the instrument to zero mode, instrument address 5:

```
<STX>ST005<SP>N<CR>
```

Data Sampling/Data Query Command (DA)

This command initiates a data transfer from the instrument. The instrument responds with measurement data, which depends on the range mode and is listed in “[Measurements reported in response to DA command](#)” below.

The command structure for a data query command is as follows:

```
<STX>DA<address><ETX><BCC>
```

The <address> is optional, which means it can be left out completely. The <address>, if present, must match the Instrument Address. Additional space can be present after the <address>.

If the <address> is left out, then no space is allowed in the query string.

A command with no address is also a valid command.

The following are the different acceptable formats of the DA command with Instrument Address 5:

```
<STX>DA<CR>
```

```
<STX>DA005<CR>
```

```
<STX>DA<SP><SP>5<ETX><BCC>
```

```
<STX>DA<ETX><BCC>
```

The data query string is valid and will be answered with data transmission only if the command starts with <STX>, which is followed by the characters DA, and the <address> (if present) matches the Instrument Address, and the command is terminated with either <CR> with no checksum or <ETX>, followed by the correct checksum <BCC>.

Sample Data Reply String in response to Data Query Command (DA):

In response to a valid data query command, the instrument responds in the following format:

```
<STX>MD02<SP><address><SP><measured
value1><SP><status><SP><SFKT><SP><address+1><SP><measured
value2><SP><status><SP><SFKT><ETX><BCC>
```

The response uses the same command terminators as used by the received command, i.e. if the received command was terminated with a <CR> then the response is terminated with <CR>, and if the command was terminated with a <ETX><BCC>, then the response is terminated with <ETX> and the computed checksum <BCC>.

The 02 after the MD indicates that two measurements are present in the reply string, 03 for three measurements and so on. This will also determine the length of the reply string.

<address> is the Instrument Address. Each subsequent measurement attached to the response will have the <address + X>, where X keeps incrementing by 1 for each measurement included.

<measured value> is the concentration value in currently selected gas units, represented as exponential representation with 4 characters mantissa and 2 characters exponent, each with sign.

Mantissa: sign and 4 digits. The decimal point is assumed to be after the first digit and is not transmitted.

Exponent: sign and 2 digits.

Example:

-5384000.0 is represented as -5384+06

+0.04567 is represented as +4567-02

<status>: is formed by < operating status > and < error status > and separated by a space, i.e.:

```
<operating status><SP><error status>
```

Each of the two (<operating status> and <error status>) are formed by two characters, each representing a 2 digit hex number which is one byte (8 Bits) operation status and one byte (8 Bits) error status.

These two bytes contain the information about the main operating conditions of the instrument at that instant. For details on how to interpret the status bytes, refer to [Table D-1](#) and [Table D-2](#) below.

<SFKT>: is the space provided for future use for special function. It currently contains a string of ten 0's, i.e. <0000000000>.

The Gesytec serial number defaults to zero. To set the Gesytec serial number select Main Menu > Instrument Controls > Communication Settings > **Gesytec Serial No.**

Example of response to DA command from an instrument with Gesytec serial number set to 000. The Gesytec serial number is **bold** in the example.

Gesytec Protocol with transmission of three concentrations (Instrument ID is 1, Operation Status is 03, Error Status is 04):

Data Query String: <STX>DA<CR>

Reply String:

```
<STX>MD03<SP>001<SP>+2578+01<SP>03 <SP>04<SP>0000000000 <SP>002 <SP>
      ↑           ↑                               ↑
      Address  First Concentration(E-format)=25.78      Address+1

+5681+00<SP>03<SP>04<SP>0000000000<SP>003<SP>+1175+01<SP>03<SP>04<SP>
      ↑                               ↑           ↑
      Second Concentration = 5.681      Address+2  Third Concentration=11.75

0000000000<SP><CR>
```

Example of response to DA command from an instrument with Gesytec serial number set to 123.

Data Query String: <STX>DA<CR>

Reply String:

```
<STX>MD03<SP>001<SP>+2578+01<SP>03 <SP>04<SP>1230000000 <SP>002 <SP>
      ↑           ↑                               ↑
      Address  First Concentration(E-format)=25.78      Address+1

+5681+00<SP>03<SP>04<SP>1230000000<SP>003<SP>+1175+01<SP>03<SP>04<SP>
      ↑                               ↑           ↑
      Second Concentration = 5.681      Address+2  Third Concentration=11.75

1230000000<SP><CR>
```

Measurements reported in response to DA command

The following measurements reported in response to DA command are for the Model 48*i*.

Single Range Mode

The 1 measurement reported in single range mode includes:

- CO

Dual/Auto Range Mode

The 2 measurements reported in dual or auto range modes include:

- low CO
- high CO

Operating and Error Status

See [Table D-1](#) for operating status and [Table D-2](#) for error status for the Model 48*i*.

Table D-1. Operating Status for Model 48*i*

	D7	D6	D5	D4		D3	D2	D1	D0
→ Bit	8	7	6	5		4	3	2	1
→ Hex-value	80	40	20	10		08	04	02	01
	MSB					LSB			
Operating status:									
Service Mode (On)	0	0	0	0		0	0	0	1
Maintenance (Local)	0	0	0	0		0	0	1	0
Zero Gas (On)	0	0	0	0		0	1	0	0
Span Gas (On)	0	0	0	0		1	0	0	0
Gas Unit Indication (ppm OR ppb)	0	0	0	1		0	0	0	0
Ozonator (Off)	0	0	1	0		0	0	0	0
PMT (Off)	0	1	0	0		0	0	0	0
Not Used	1	0	0	0		0	0	0	0

Table D–2. Error Status for Model 48*i*

	D7	D6	D5	D4		D3	D2	D1	D0
→ Bit	8	7	6	5		4	3	2	1
→ Hex-value	80	40	20	10		08	04	02	01
	MSB					LSB			
Error status:									
Internal Temperature Alarm	0	0	0	0		0	0	0	1
Optical Chamber Temperature Alarm	0	0	0	0		0	0	1	0
AGC Intensity Alarm	0	0	0	0		0	1	0	0
Bias Voltage Alarm	0	0	0	0		1	0	0	0
Pressure Alarm	0	0	0	1		0	0	0	0
Sample Flow Alarm	0	0	1	0		0	0	0	0
Motor Speed Alarm	0	1	0	0		0	0	0	0
Not Used	1	0	0	0		0	0	0	0