

1port Remote I/O Controller  
(dry / wet contact support)

## CIE-H12 User's Manual

Version 1.6



Sollae Systems Co., Ltd.

<http://www.ezTCP.com>



To all residents of the European Union

Important environmental information about this product

This symbol on this unit or the package indicates that disposal of this unit after its lifecycle could harm the environment. Do not dispose of the unit as unsorted municipal waste; it should be brought to a specialized company for recycling. It is your responsibility to return this unit to your local recycling service. Respect your local environmental regulation. If in doubt, contact your local waste disposal authorities.

# Contents

<b>Contents</b> .....	<b>- 2 -</b>
<b>1 Introduction</b> .....	<b>- 5 -</b>
1.1 Introduction.....	- 5 -
1.2 Application Examples.....	- 6 -
1.3 Components.....	- 7 -
1.4 Specification.....	- 7 -
1.4.1 H/W specification.....	- 7 -
1.4.2 S/W specification.....	- 7 -
1.5 Interface.....	- 8 -
1.5.1 Input Ports.....	- 8 -
1.5.2 Output Ports.....	- 10 -
1.5.3 Ethernet Interface.....	- 11 -
1.5.4 Power.....	- 11 -
1.5.5 System LED.....	- 12 -
1.5.6 ISP Switch.....	- 12 -
<b>2 Installation and Test</b> .....	<b>- 13 -</b>
2.1 Installation.....	- 13 -
2.1.1 Setting Network Aera.....	- 13 -
2.2 Test operation.....	- 15 -
2.2.1 Modbus/TCP Test.....	- 15 -
2.2.2 HTTP Test with a WEB browser.....	- 17 -
<b>3 Configuration</b> .....	<b>- 18 -</b>
3.1 Configuration with ezManager.....	- 18 -
3.1.1 Configuration via LAN.....	- 18 -
<b>4 Operation Modes</b> .....	<b>- 19 -</b>
4.1 What is the Operation Mode?.....	- 19 -
4.2 How to change the mode to another.....	- 19 -
4.3 Comparison of the each mode.....	- 20 -
4.4 Normal Mode.....	- 20 -
<b>5 Methods for I/O control</b> .....	<b>- 21 -</b>
5.1 MODBUS/TCP.....	- 21 -
5.1.1 Related Parameters.....	- 21 -
5.1.2 Modbus/TCP Slave Mode.....	- 22 -

5.1.3	Modbus/TCP Master Mode.....	- 22 -
5.1.4	TCP Connection Modes.....	- 23 -
5.1.5	Initial Output Value.....	- 23 -
5.1.6	Write Pulse.....	- 23 -
5.2	Macro Mode.....	- 24 -
5.2.1	Operator.....	- 24 -
5.2.2	Operand.....	- 24 -
5.2.3	An Example of Equations.....	- 25 -
5.3	Monitoring and controlling on Web (HTTP).....	- 26 -
5.3.1	Changing port number for HTTP.....	- 26 -
5.3.2	Uploading Users' Webpage.....	- 27 -
<b>6</b>	<b>System Management.....</b>	<b>- 28 -</b>
6.1	Upgrading Firmware.....	- 28 -
6.1.1	Firmware.....	- 28 -
6.1.2	Processes.....	- 28 -
6.2	Changing Homepage.....	- 30 -
6.2.1	Homepage.....	- 30 -
6.2.2	Processes.....	- 30 -
6.3	Status Monitoring.....	- 32 -
6.3.1	Using TELNET.....	- 32 -
6.3.2	Checking status by ezManager.....	- 34 -
6.3.3	Debugging Message.....	- 36 -
<b>7</b>	<b>Additional Functions.....</b>	<b>- 38 -</b>
7.1	Security.....	- 38 -
7.1.1	Restriction of Access (ezTCP Firewall).....	- 38 -
7.1.2	Setting Password.....	- 38 -
7.1.3	Valid Time.....	- 39 -
7.1.4	Delay.....	- 39 -
7.2	Option Tab Functions.....	- 40 -
7.2.1	Notify IP Change.....	- 40 -
<b>8</b>	<b>Self-Test in Trouble.....</b>	<b>- 41 -</b>
8.1	Searching problem with ezManager.....	- 41 -
8.2	Connection Problem over Modbus/TCP.....	- 42 -
8.3	Communication Problem over Modbus/TCP.....	- 43 -
<b>9</b>	<b>Technical Support, Warranty, and Precaution.....</b>	<b>- 44 -</b>
9.1	Technical Support.....	- 44 -

9.2	Warranty.....	- 44 -
9.2.1	Refund.....	- 44 -
9.2.2	Free Repair Services.....	- 44 -
9.2.3	Charged Repair Services.....	- 44 -
9.3	Precaution.....	- 45 -
<b>10</b>	<b>History.....</b>	<b>- 46 -</b>



# 1 Introduction

## 1.1 Introduction

In the era of Ubiquitous Environment, many kinds of systems which use sensors like temperature, humidity or pressure and controlling the power of remote devices have been developing. The CIE-H12 monitors those sensors detecting the digital inputs and controls the remote devices as a switch. HTTP, Modbus/TCP and Macro mode can be used for these functions.

The CIE-H12 has two input ports and one output port. One of the input ports is a dry-contact type and the other one is wet-contact. Thus, you are allowed to use it under both types of systems.



## 1.2 Application Examples

- remote I/O device server

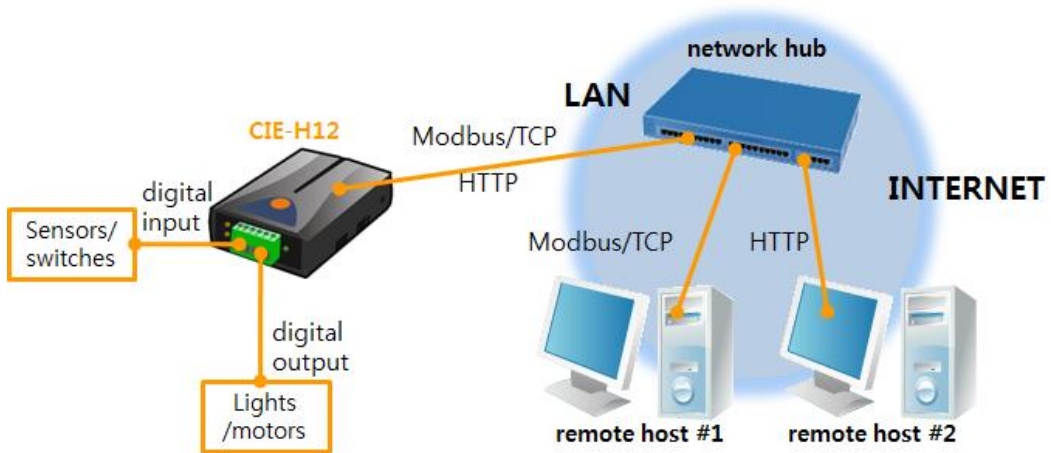

Figure 1-1 remote I/O device server

- Internet Switch

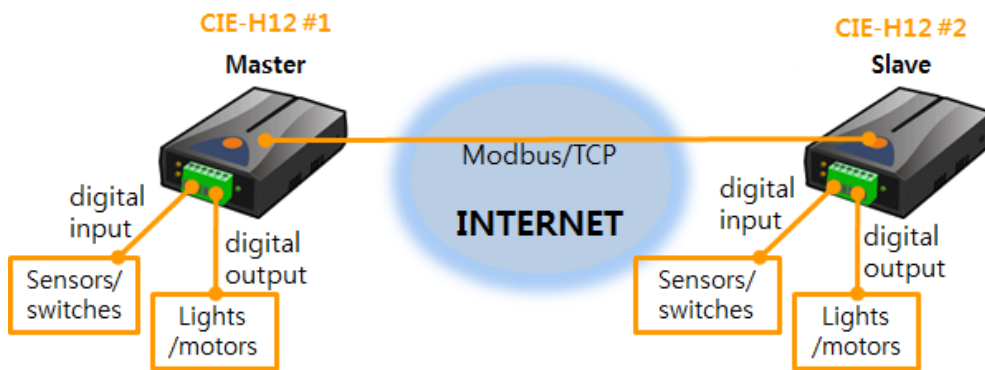

Figure 1-2 internet switch

- Macro mode

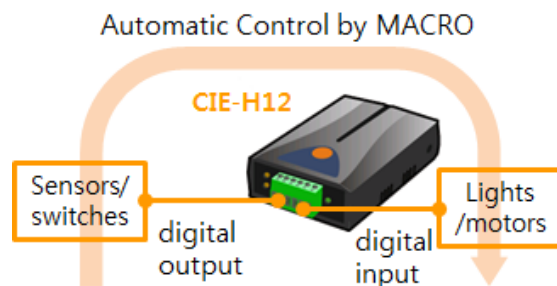

Figure 1-3 macro mode

## 1.3 Components

- The CIE-H12's body
- 5V Power Adapter

## 1.4 Specification

### 1.4.1 H/W specification

Power	Input Power	5V (±10%)
	Current Consumption	305mA typical
Size	96mm x 57mm x 24mm	
Weight	Approximately 68g	
CPU	ARM7 Core	
Interfaces	Digital Input	2 ports with photo couplers (2 input types)
	Digital Output	1 port with relays
	Network	RJ45
Network	Ethernet 10Base-T or 100Base-TX (Auto-Sensing) Auto MDI/MDIX(Cable Auto-sensing)	
Temperature	Operate: 0 ~ 70°C / Storage: -40 ~ 85°C	
Certification	CE: F690501/RF-EMY006493 / KC: KCC-REM-SLS-CIE-H12	
Environment	Follows Europe RoHS Directive	

### 1.4.2 S/W specification

Protocol	TCP, UDP, IP, ICMP, ARP, DHCP, DNS lookup, DDNS, Modbus/TCP, HTTP	
Diagnose	Online Debugging Function	
Operation mode	Normal	Normal communication mode
	ISP	F/W upgrade
Communication Mode	I/O server	Modbus/TCP – Slave/Master, Passive/Active Web Browser(HTTP), Macro(Stand-alone)
Programs	ezManager	Configuration program via LAN
	ModMap	Modbus/TCP Application for Windows



## 1.5 Interface

### 1.5.1 Input Ports

The CIE-H12 has two input ports and each has a different type from the other. One is a "DRY CONTACT" type and the other is a "WET CONTACT."

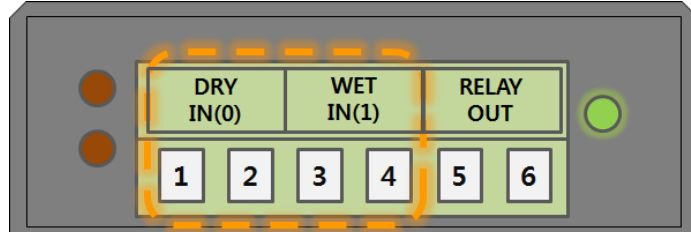

Figure 1-4 input ports (the front view)

In the front panel, the DRY IN(0) port is the dry contact type and the WET IN(1) port is the wet contact type.

- The switch input type (Dry contact)

The first input port is a dry contact type so you can give the input signal by a switch. Basically, this port is the same with the port INPUT2 but has an additional part for dry contact. Just use a switch for giving signal to this port.

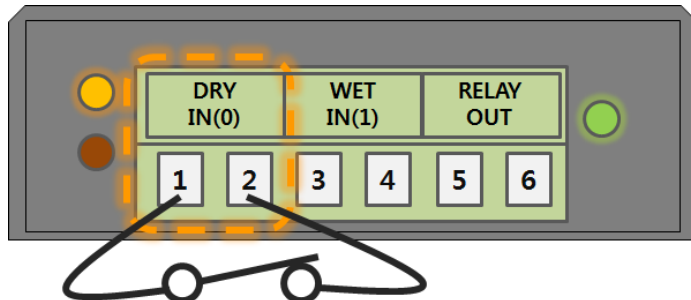

Figure 1-5 the dry contact input port

- The voltage input type (Wet contact)

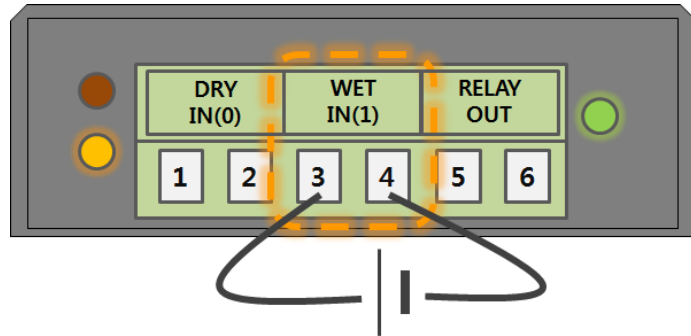

Figure 1-6 the wet contact input port

You can give a DC voltage to input signal to this port. This port is isolated by photo-couplers and you don't have to care about the polarity. The circuit diagram of the input port is shown in the figure below. The [EXTERNAL INPUT1] and [EXTERNAL INPUT2] port should be interfaced with the user device.

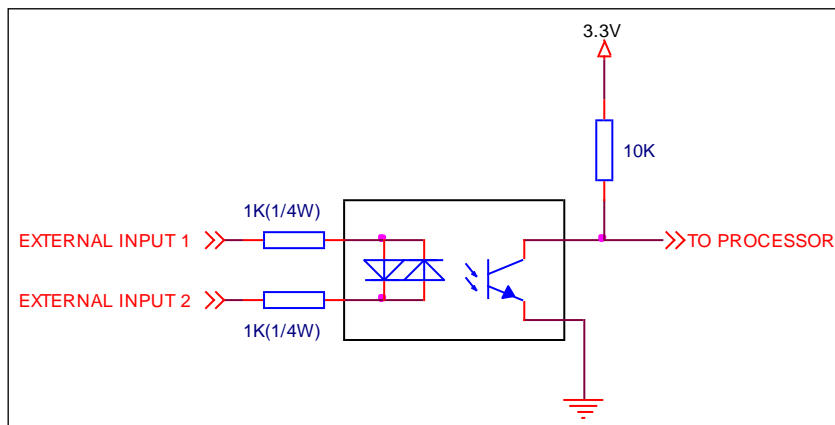

Figure 1-7 a circuit diagram of the input port

The voltage specification of the input port is as follows:

Table 1-1 the voltage specification of the input ports

Max. Input Voltage	DC24V		
$V_{IH}$	Min. 1.8V	H	1
$V_{IL}$	Max. 1.2V	L	0

This input port is interfaced with a 3.5mm terminal block. Thus, use a (-) shaped screwdriver to connect it with the user device.

### 1.5.2 Output Ports

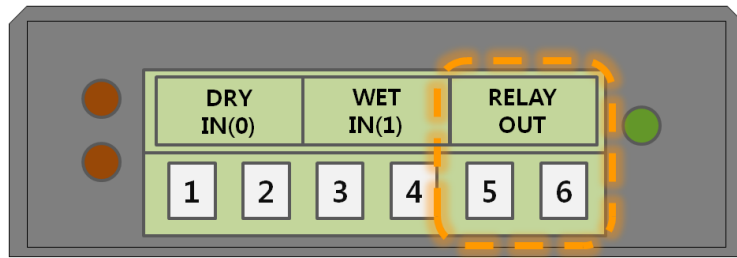

Figure 1-8 the output port (the front view)

The port 5 and 6 (OUTPUT) is output port and this port is interfaced with a relay as shown below. The [EXTERNAL OUTPUT1] and [EXTERNAL OUTPUT2] port should be interfaced with the user device.

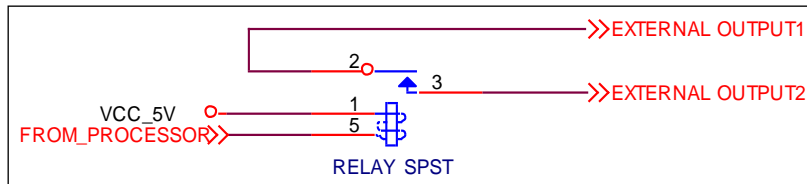

Figure 1-9 a circuit diagram of the output port

The output port operates as in the following

Table 1-2 values of the output port

Value	Relay contact
0	OFF (open)
1	ON (short)

The allowed output ports' electrical current of voltage conditions are as in the following:

Table 1-3 voltage conditions of the output port

Voltage Condition	Allowed current
DC28V	5A

Because the output ports are interfaced with a 3.5mm terminal block, use a (-) shaped screwdriver to connect it with users' devices.

☞ *The CIE-H12 is most appropriate for switching devices in lower voltage conditions than that. Or High capacity relay is recommended.*

### 1.5.3 Ethernet Interface

An RJ45 connector is for the network interface of the CIE-H12. You can use a UTP cable. It automatically senses 10Mbps or 100Mbps Ethernet. It also provides auto MDI/MDIX function that can automatically sense 1:1 cable or cross over cable.

Each Ethernet device has its own hardware address. The hardware address of the CIE-H12 is fixed in the factory before being shipped to the market. (The hardware address is also known as the MAC address)

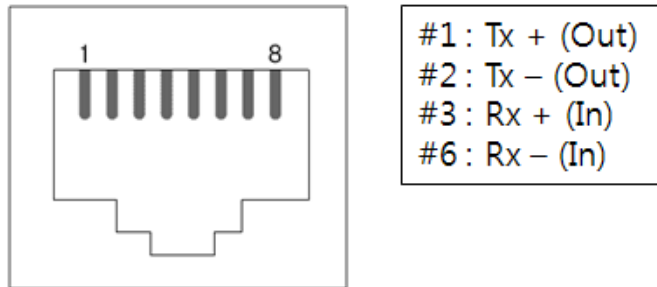

Figure 1-10 the RJ45 connector

### 1.5.4 Power

DC 5V is used for the power. The specification of the power jack is as following:

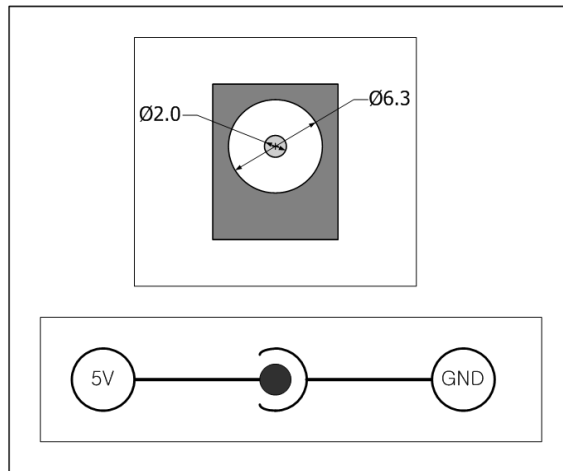

Figure 1-11 the power specification

### 1.5.5 System LED

The CIE-H12 has 2 LEDs on RJ45 and the current system status LEDs for out port and input ports.

Each LED shows the following status:

Table 1-4 status of the system LED

place	name	color	LED status	description
RJ45	STS	Yellow	blinks in every second	assigned an IP address
			blinks 4 times at once	without being assigned an IP address by DHCP
			On	establishing a TCP connection
			Off	operating for the ISP mode
	LINK	Green	On	establishing a connection on a network
			blinks	transferring or receiving network data
Front panel	DI	Yellow	On	when input ports' signal is ON
	DO	Green	On	when the output port's signal is ON

### 1.5.6 ISP Switch

There is an ISP switch located on the side of the product. This button is for changing the mode to the ISP mode. If the button is pressed over a second or the power is supplied when you are pressing the button, the CIE-H12 will be operated as ISP mode.



Figure 1-12 ISP switch

☞ *In the ISP the password and access restriction could be restored or reset. Use these modes when you are faced with these problems.*

## 2 Installation and Test

### 2.1 Installation

Let's look into the operation of the CIE-H12. Basically, the input ports and the output port are independently used. Thus, you can use the input ports only or the output port only. Of course you can also correlatively use those ports by using the MACRO mode on the output port.

Before testing the CIE-H12, you should connect the Ethernet port to a PC. It will be no problem that the Ethernet connection is established through network hubs.



Figure 2-1 the connection between H12 and a PC

#### 2.1.1 Setting Network Area

This step is for setting both the CIE-H12 and your PC to be located the same network. If only they are, the TCP connection between them can be established.

- Setting of the PC

Add or change the IP address of the network adapter on your PC.

Get into the menu of [Windows Control Panel] >> [Network Connections] >> [Properties of the Network Adapter – with right click of your mouse]. Then, you can show the properties of [Internet Protocol (TCP/IP)]. Press the [Advanced..] button and add an IP Address like the figure below.

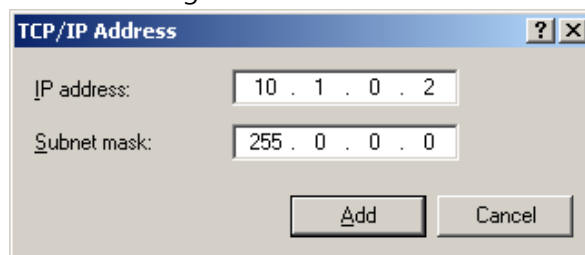

Figure 2-2 adding / changing an IP address

- Setting of the CIE-H12

ezManager is the management tool for configuration of the CIE-H12. This application is only for MS Windows and this is comfortable to use because it doesn't need installation process.

First, search your CIE-H12 via network. All the values of parameters are set to the default values in the factory. To apply it to your system, proper values should be set via ezManager.

Default values of some major parameters are listed on the table below. To do the following simple test, keep these values without any changes.

Table 2-1 default values of some major parameters

Parameters		Values
Network	Local IP Address	10.1.0.1
	Subnet Mask	255.0.0.0
Option	Telnet	Checked
	IP Address Search	Checked
I/O Port	Web (HTTP)	Checked
	Web (HTTP) Port	80
	Modbus/TCP	Checked
	Master/Slave	Slave
	Connection Mode	Passive Connection
	Multiple Connection	1
	Peer Port	502

☞ You can download the latest version of ezManager on the [Support] >> [Download] >> [Utilities] page on our website.

## 2.2 Test operation

### 2.2.1 Modbus/TCP Test

This is for checking the operation of Input and output ports of the CIE-H12 via Modbus/TCP. In this instruction, offered Modbus/TCP test program was used.

Run ezManager. Then, you can show the window like the figure below.

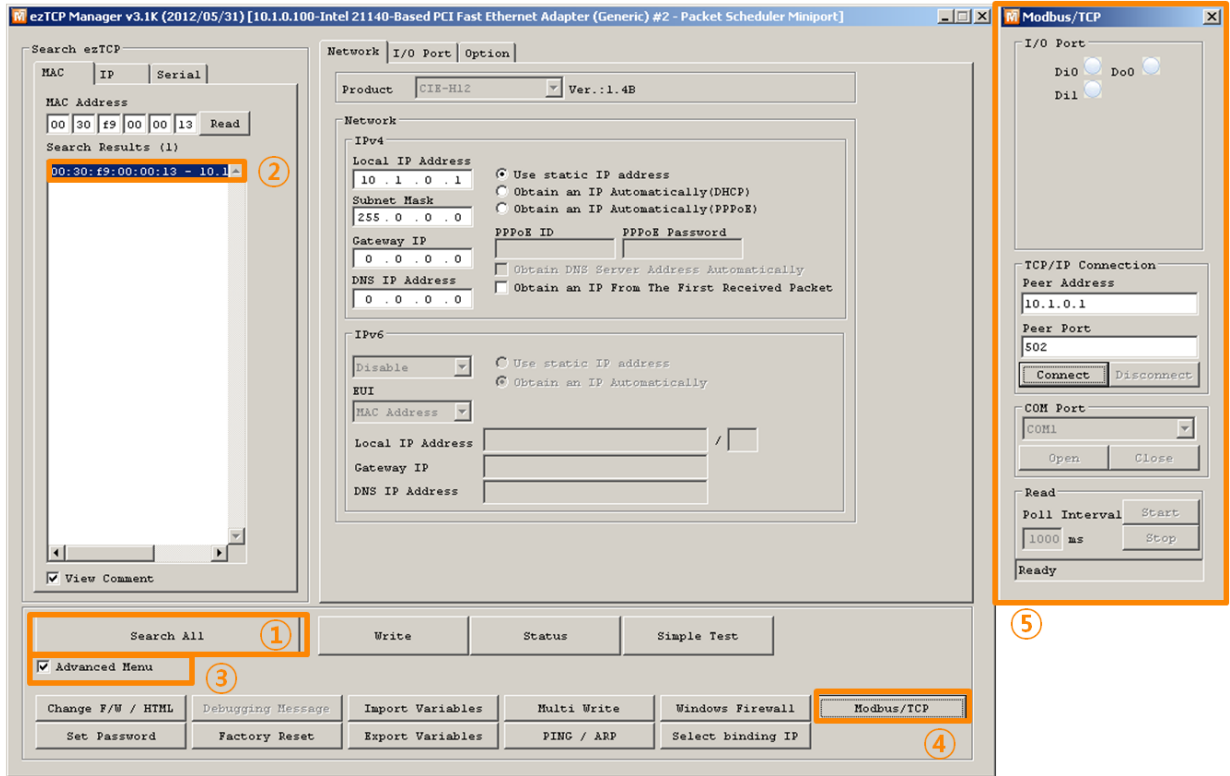

Figure 2-3 Modbus/TCP test program of the ezManager

- ① Search connected the CIE-H12 with [Search All] button.
- ② Select a MAC address of searched product on the [search result].
- ③ Check the [Advanced Menu] option.
- ④ Press the [Modbus/TCP] button.
- ⑤ The test program will appear on the right side of the ezManager

☞ *In the case of using previous versions of firmware than 3.1F the test program is shown automatically when you success in searching the product.*



● Modbus/TCP test

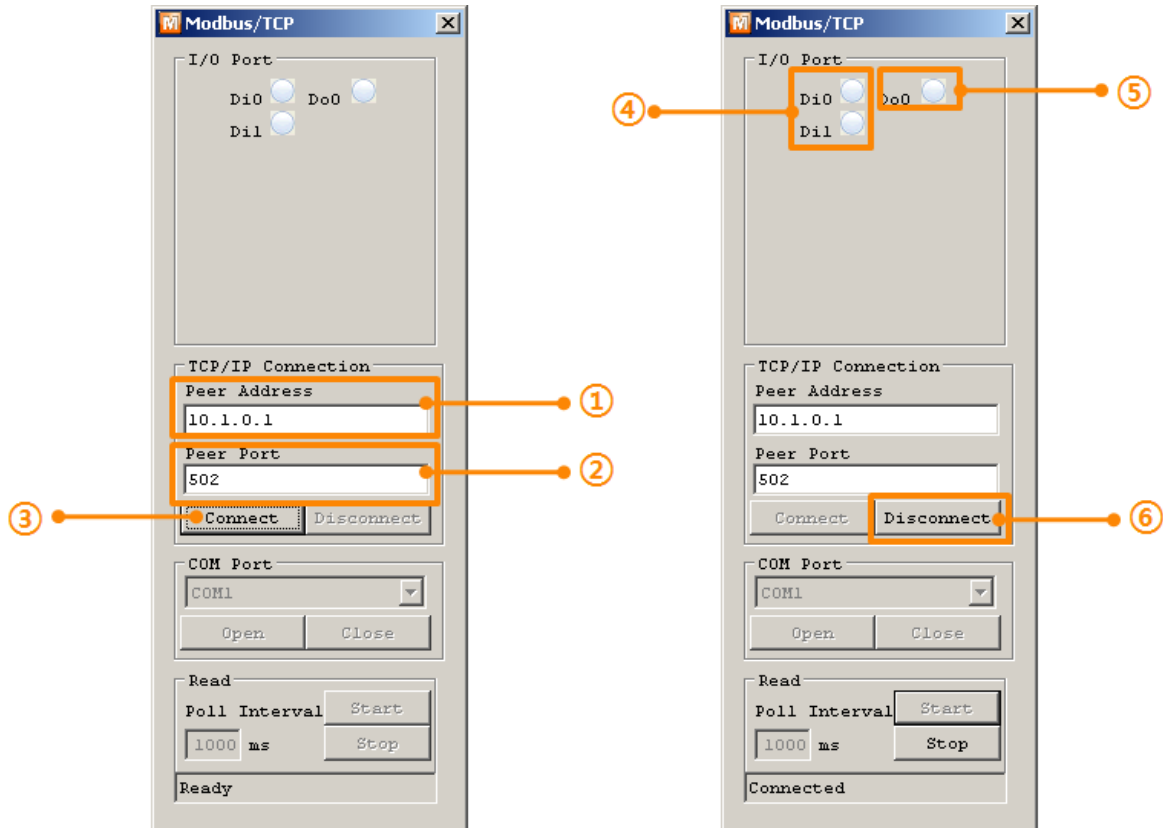

Figure 2-4 Modbus/TCP test

- ① Input the IP address of the CIE-H12
- ② Input the local port for Modbus/TCP of the CIE-H12

☞ *In a local area network, ① and ② steps can be omitted.*

- ③ Try to connect by pressing [Connect] button
- ④ Then, check if the input LEDs are turned on or off with signal input
- ⑤ Check if the output LED is turned on or off with clicking the LEDs
- ⑥ Click the [Disconnect] button after the test is completed

## 2.2.2 HTTP Test with a WEB browser

This is for testing the operation of Input and output ports of the CIE-H12 via HTTP. The test was implemented with a WEB browser. You can use WEB browsers such as MS Internet Explorer, Google Chrome and Mozilla Firefox.



Figure 2-5 HTTP test

- ① Input the IP address of your CIE-H12 on the address field (Ex: 10.1.0.1).
- ② Check if the input LEDs are turned on or off with HIGH signal.
- ③ Check if the output LED is turned on or off with clicking the each of LEDs.
- ④ Press the [Read] button to update the status.

# 3 Configuration

## 3.1 Configuration with ezManager

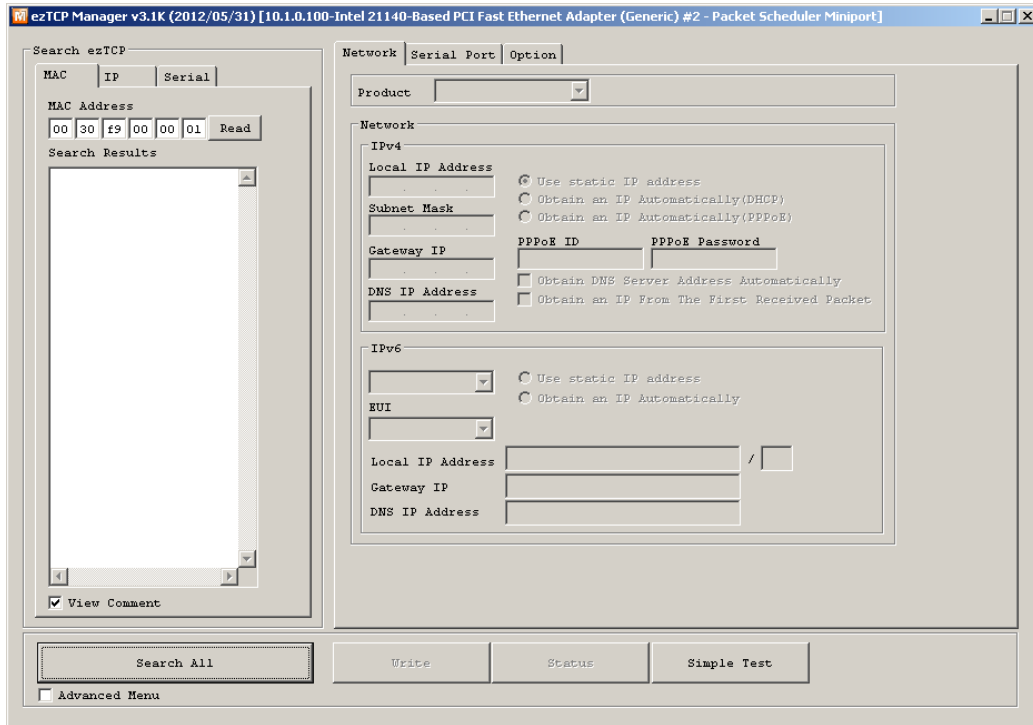

Figure 3-1 initial appearance of ezManager

### 3.1.1 Configuration via LAN

- Checklists

Make sure of the connection between your PC and the CIE-H12 via Ethernet. If they are in the same network, [MAC Address search] button can be used. If they aren't, only [IP Address search] is allowed to use.

- Procedures

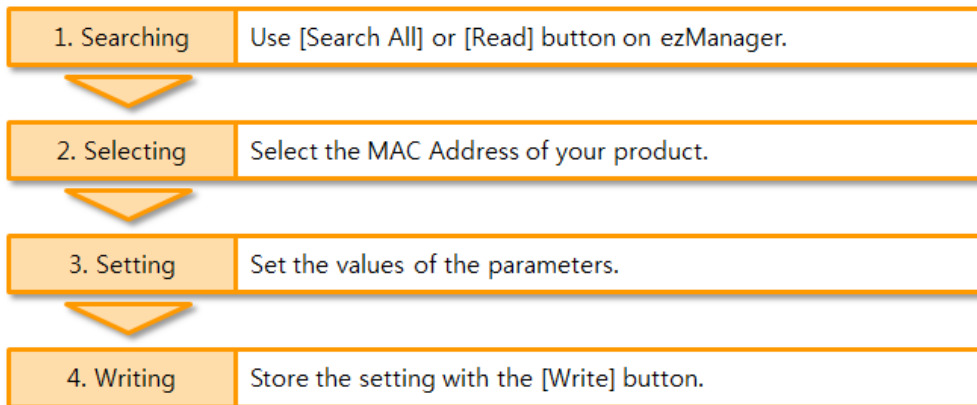

Figure 3-2 procedures for configuration via LAN

## 4 Operation Modes

### 4.1 What is the Operation Mode?

Each of two operation modes are designed for specific purposes, and those are as follows:

- Normal mode  
This mode is for normal data communication and has 5 different communication modes. Configuring parameters is also available in this mode.
- ISP mode  
This mode is for upgrading firmware. In addition, you can set environmental parameters even though the security options are activated and you can also reset the security options.

### 4.2 How to change the mode to another

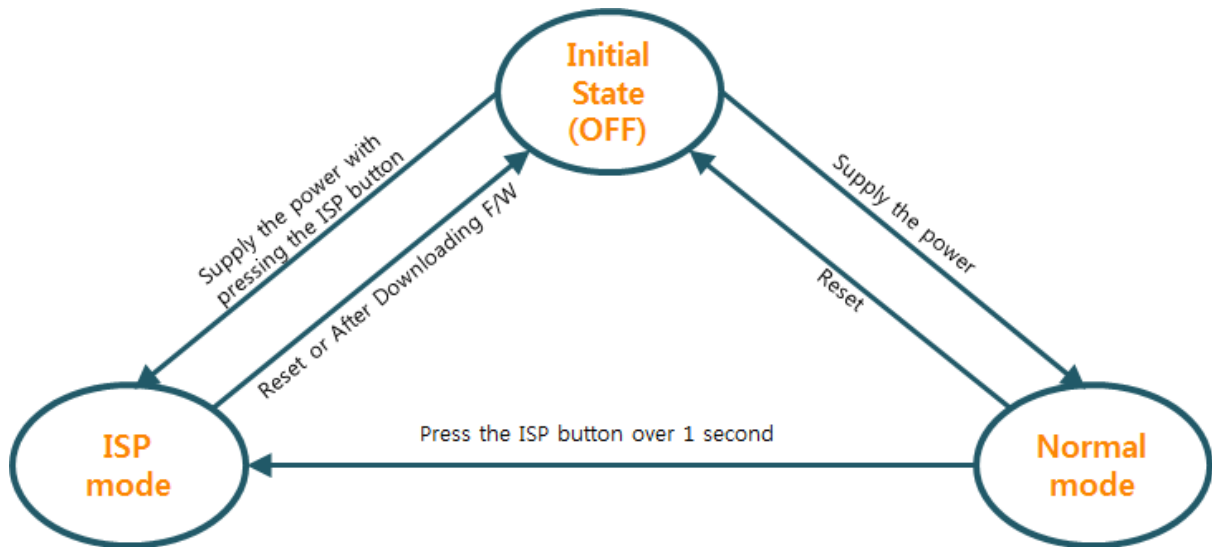

Figure 4-1 how to initiate each operation mode

### 4.3 Comparison of the each mode

The following table shows summaries of the each mode.

Table 4-1 comparison of the each mode

Name	Entering
Normal	Supply the power.
ISP	Supply the power with pressing the ISP button or press the ISP button over 1 sec in other modes.

### 4.4 Normal Mode

In normal mode, there are four types of ways to monitor and control I/O.

- control types

Table 4-2 digital I/O control types

Types	Description
Modbus/TCP	Control and monitor the I/O of the CIE-H12 via Modbus/TCP. It supports both master and slave mode.
Macro	Users can automatically control the output ports by setting MACRO using some basic formula of Boolean Algebra.
WEB(HTTP)	Users can monitor and control the CIE-H12 via HTTP

## 5 Methods for I/O control

### 5.1 MODBUS/TCP

The CIE-H12 supports Modbus/TCP. By using this protocol, it remotely monitors and controls I/O devices. To use this method, your application should support this protocol.

#### 5.1.1 Related Parameters

Table 5-1 Modbus/TCP related parameters

Parameters	Descriptions
Modbus/TCP	Using Modbus/TCP for controlling I/O ports of the CIE-H12.
Slave	The slave responses by queries from the Master
Master	The Master sends queries to the slaves
Poll Interval	the period for sending queries (Unit: ms, Minimum value: 10)
Unit ID	ID for identifying the device or the pair of devices.
Input Port Base Address	Initial address of the input ports
Output Port Base Address	Initial address of the output ports
Passive Connection	waiting for accepting a Modbus/TCP connection
Active Connection	requesting a Modbus/TCP connection
Multiple Connection	The numbers for multiple Modbus/TCP connections.
Control Method of (FC XX)	Control method for the output ports of the slave (Single / Multiple)
Control Method of (AND/OR)	Control method for the output ports of the master (AND / OR)
Peer Address	Peer's IP address when the CIE-H12 performs active connections
Peer Port (Active)	Peer's local port when the CIE-H12 performs active connections
Peer Port (Passive)	Local port
Input Change Notification	A function for immediate notification with changing the IP address.
Macro	Applying macro function on the output port
Initial State	Output port value when the CIE-H12 boots up.

☞ We recommend that you do not change the input and output port base address if you don't need to.

### 5.1.2 Modbus/TCP Slave Mode

According to the standard Modbus/TCP you can use a Modbus/TCP manager to control and monitor their I/O devices. Like this standard, you can set the CIE-H12 to the [Slave] item to [Slave] mode. The [Passive] connection would be better than the [Active] in this mode and the [Peer Port] should be 502.

Table 5-2 values for standard Modbus/TCP

Modbus/TCP Mode	Slave
TCP Connection	Passive
TCP Port	502

Configure the proper values of [Unit ID], [Input Port Base Address], and [Output Port Base Address].

### 5.1.3 Modbus/TCP Master Mode

In this mode, the CIE-H12 operates as a Modbus/TCP master. As a master the CIE-H12 sends queries which read the values of the input ports and which change the values of the output ports to the Modbus/TCP slave devices. At this time, the CIE-H12 controls the output ports with not only bit unit (individually) but also word unit (at once)

- FC 16(Multiple)  
CIE-H12 controls the output ports and monitors the input ports of slaves with WORD unit by FC16 (write multiple register) and FC 03 (read multiple register)
- FC 05(Single)  
CIE-H12 controls the output ports and monitors the input ports of slaves with BIT unit by FC05 (write coil) and FC02 (read input discretes).

### 5.1.4 TCP Connection Modes

In the standard of Modbus TCP, the master program should make a connection to the slave using port number 502. However, sometimes Modbus/TCP devices should try connecting to the master actively. For this case, the CIE-H12 supports the active connection mode.

Table 5-3 the passive / active connection

The passive connection	<ul style="list-style-type: none"> <li>- standard Modbus/TCP</li> <li>- Remote host connects to the CIE-H12.</li> <li>- Port number that is used for communication must be designated</li> </ul>
The active connection	<ul style="list-style-type: none"> <li>- The CIE-H12 tries to establish a connection to the remote host</li> <li>- The IP address (or host name) and port number of the remote host is required</li> </ul>

### 5.1.5 Initial Output Value

The initial value of the CIE-H12's output port can be configured. Depending on the value of [Initial State] at the boot time, output ports are set to ON or OFF.

### 5.1.6 Write Pulse

By using the function code 105, you can give the signal of pulse type to the output ports. This means the output signal is kept during specified time configured by users.

☞ *For more details about the Modbus/TCP protocol, please refer to the document on the [SUPPORT] >> [Download] >> [Technical Documents] page of our web site.*



## 5.2 Macro Mode

This mode let users set the values of the output ports with simple macros. The CIE-H12 reflects the values according to the macro expressions which are configured by users in advance. It will be useful when users set the output values automatically from combinations of inputs. Check [Macro] options on ezManager to activate this mode.

### 5.2.1 Operator

The algorithm used in the Macro mode is Boolean algebra. In this case, the AND, OR, NOT are used as operators. Parenthesis may also be used.

The priority of operators is in the following order: parenthesis > NOT > AND > OR.

Each operator is represented by the following symbols.

Table 5-4 the operators

Name	Sign	Description
Parenthesis	( )	Since calculations within the parenthesis have the highest priority, they will be calculated first. Parenthesis may be nested used.
NOT	/	Operand that follows NOT operator is toggled. (If operand is 0, it will be changed to 1. If it is 1, it will be changed to 0.)
AND	*	If Operand values that surrounds AND operator all 1, the result value will be 1. If either one of them is 0, the result will be 0 as well.
OR	+	If Operand values that surrounds AND operator all 0, the result value will be 0. If either one of them is 1, the result will be 1

### 5.2.2 Operand

Operands used in macro mode are each input port. Each input port is designated with i0 and i1 symbol based on their sequence. Since capital letters are not recognized, they can also be written as I0 and I1.

*The output ports couldn't be used as an operand.*

### 5.2.3 An Example of Equations

Here are two examples. In the expressions, spaces between the two operands will be ignored.

Table 5-5 an example of equation

Do0 ex. 1	$i0 + i1$	Perform bit OR $i0$ and $i1$
Do0 ex. 2	$!(i0 * i1)$	Perform bit AND $i0$ and $i1$ . Then, toggle the result

Based on input values from three input ports, the output values are as follows:

Table 5-6 the logic table of the table 5-5

Input ports		Output port	
$i0$	$i1$	Do0 ex. 1	Do0 ex. 2
0	0	0	1
0	1	1	1
1	0	1	1
1	1	1	0

### 5.3 Monitoring and controlling on Web (HTTP)

After starting the web browser, input the CIE-H12's IP address after typing http:// in the address window to connect to the CIE-H12.

If the CIE-H12 has a password set, a window for authentication will be popped up.

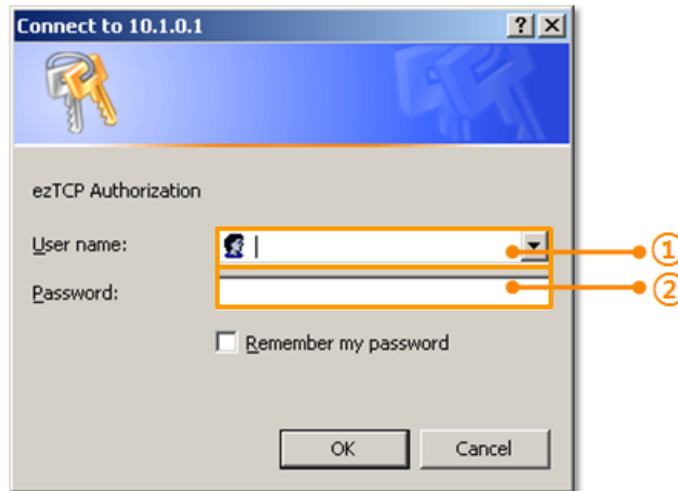

Figure 5-1 authentication with password

- ① the CIE-H12 does not care the [User name]. (You don't have to fill the box)
- ② [Password] should be the same with password which is set through the ezManager.

#### 5.3.1 Changing port number for HTTP

In case you cannot use the port number 80(default port number for HTTP) because the ISP (Internet Service Provider) blocks the port, you can change that port number.

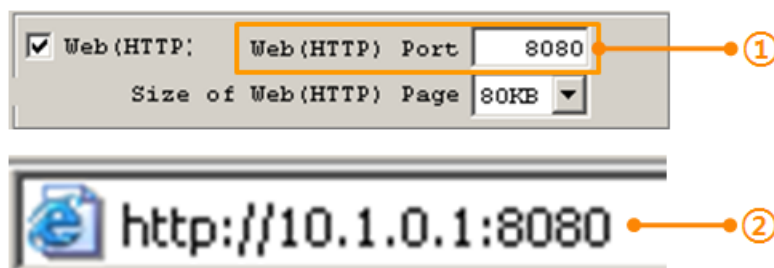

Figure 5-2 changing port number for HTTP

- ① Input a port number to the [Web(HTTP) Port] text box.
- ② Input the IP address of the CIE-H12 with changed port number and "http://"

### 5.3.2 Uploading Users' Webpage

This function is available to anyone who can make HTML files. If you get some simple syntax, it is possible to monitor and control the I/O ports with your webpage made by yourself.

- Upgrading HTML files

CIE-H12 has a default webpage when it is manufactured in the factory. For advanced users, we have been offering some examples (sample web pages) based on various technologies such as CSS and J query.

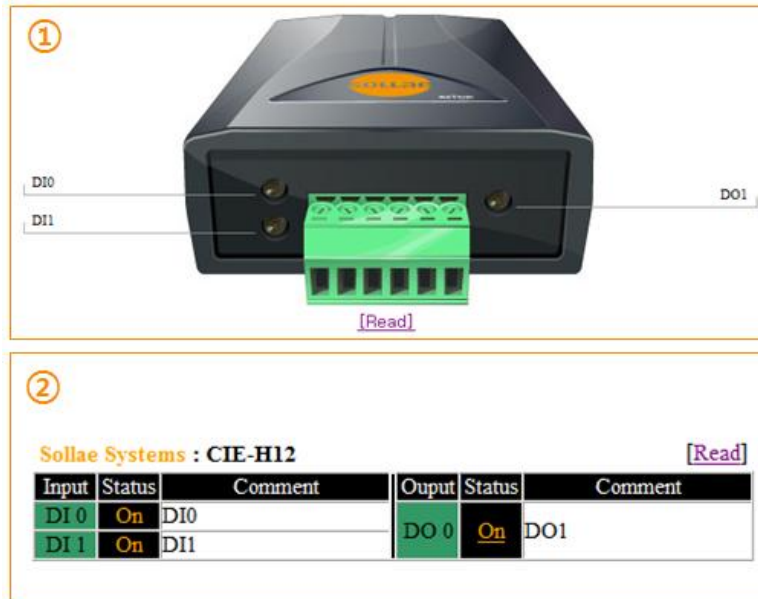

Figure 5-3 examples of webpage

- ① Default image based / advanced CSS / JQuery
- ② Text based

## 6 System Management

### 6.1 Upgrading Firmware

#### 6.1.1 Firmware

Firmware is a type of software for operation of the CIE-H12. If there are needs for adding function or fixing bugs, the firmware will be modified and released. We recommend that users keep use the latest released firmware.

#### 6.1.2 Processes

- Downloading the latest released firmware  
Download the newest firmware file. We update our homepage when a new firmware is released. You can find it on our website.
- Entering ISP mode  
Enter ISP mode to download firmware file to the CIE-H12.
- Run a TFTP client and ready to send the F/W file  
Run a TFTP client program. ezManager is equipped the client program. Click the [Change F/W / HTML] button.

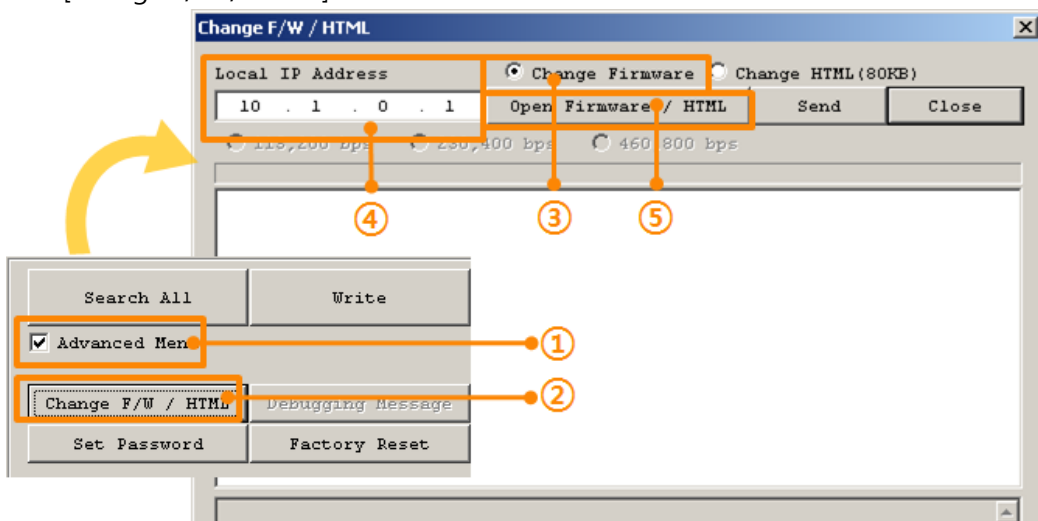

Figure 6-1 running TFTP client

- ① Check the [Advanced Menu] check box
- ② Click the [Change F/W / HTML] button to run TFTP client
- ③ Select the [Change Firmware] radio button
- ④ Input the IP address of the CIE-H12 to the [Local IP Address] text box
- ⑤ Press the [Open Firmware / HTML] button and choose the firmware file

- Checking firmware file and Sending

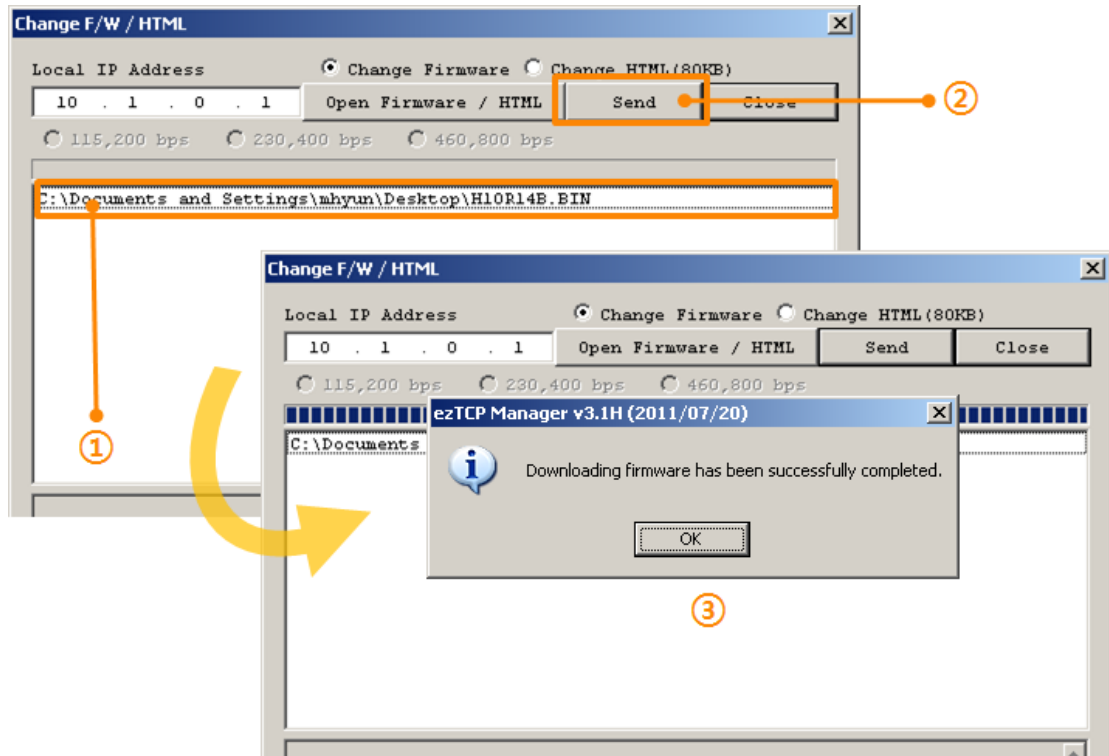

Figure 6-2 sending firmware file

- ① Check if the name and path of the firmware file are correct
- ② Click the [Send] button
- ③ Confirm the completed message

## 6.2 Changing Homepage

### 6.2.1 Homepage

To monitor and control, homepage should be uploaded in the CIE-H12.

### 6.2.2 Processes

- Making Users' homepage or Downloading sample files  
Make your own homepage file or use sample homepage files which we've been offering on our web site.
- Entering ISP mode  
Enter ISP mode to send HTML files to the CIE-H12.
- Running a TFTP client and ready to send the HTML files  
Run a TFTP client program. ezManager is equipped the client program. Click the [Change F/W / HTML] button.

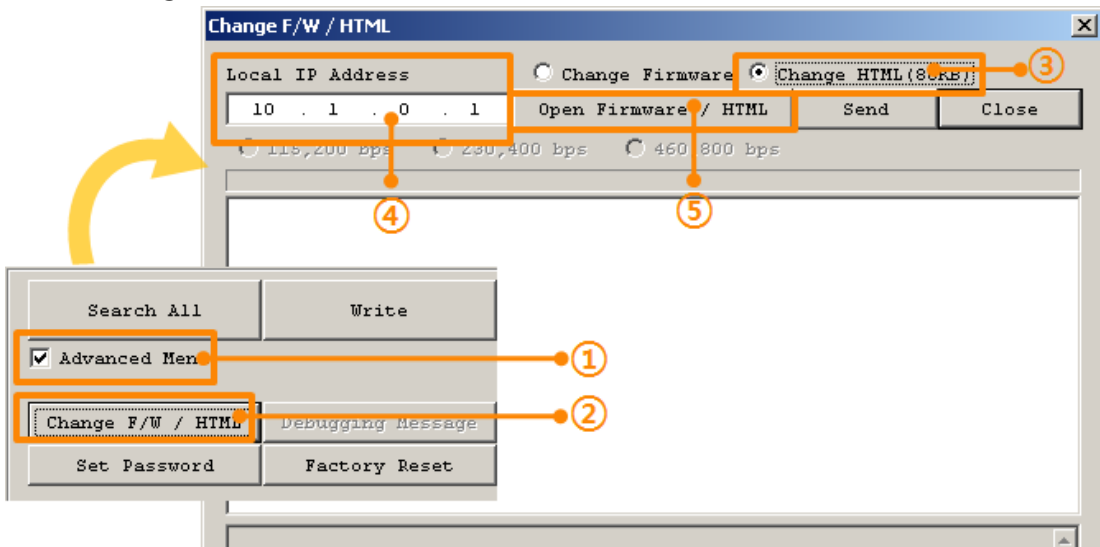

Figure 6-3 running TFTP client

- ① Check the [Advanced Menu] check box
- ② Click the [Change F/W / HTML] button to run TFTP client
- ③ Select the [Change HTML] radio button
- ④ Input the IP address of the CIE-H12 to the [Local IP Address] text box
- ⑤ Press the [Open Firmware / HTML] button and choose the HTML file

- Checking firmware file and Sending

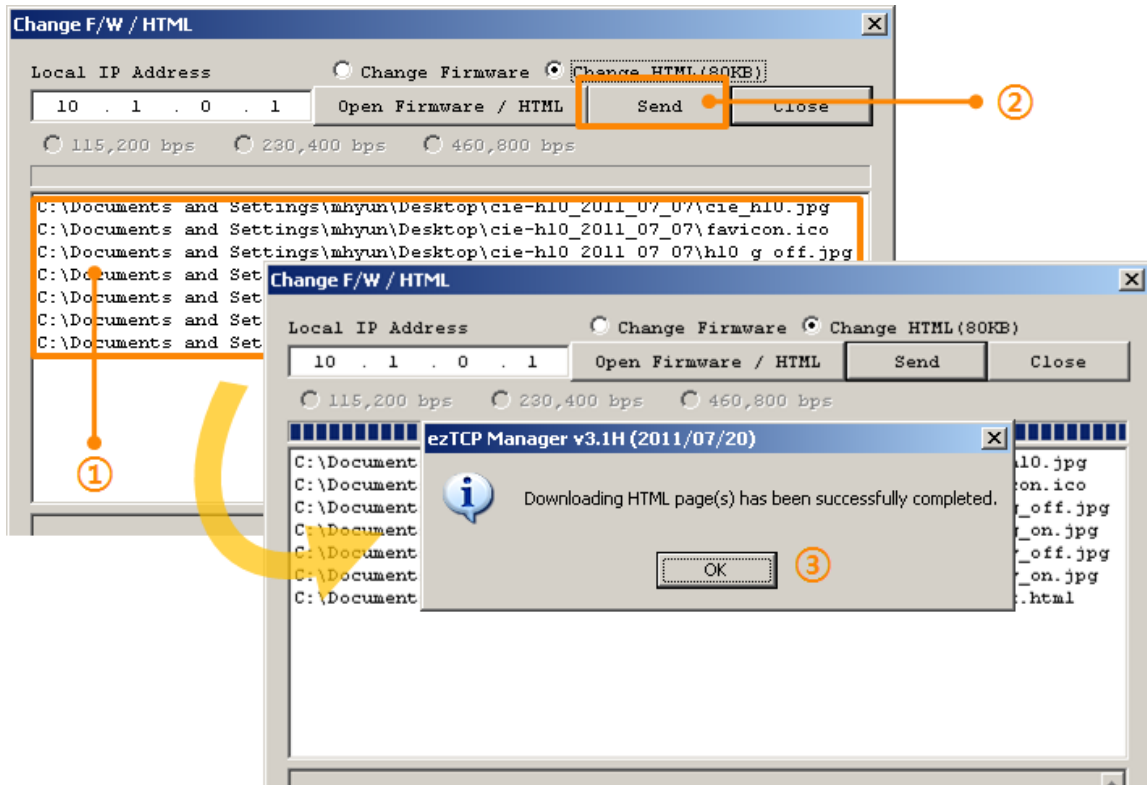

Figure 6-4 sending firmware file

- ① Check if the name and path of the html file including all images are correct
- ② Click the [Send] button
- ③ Confirm the completed message



## 6.3 Status Monitoring

### 6.3.1 Using TELNET

Once the [TELNET] option is activated, users can remotely log in to the CIE-H12. If a password is set, users should input the password.

After then, messages from the CIE-H12 appear like the figure below.

```
CIE-H12 Management Console v1.4B Sollae Systems
lsh>
```

Figure 6-5 log in to the CIE-H12 on TELNET

You can check multiple states with the following commands.

Table 6-1 Commands for checking states

command	option	description	usage
st	net	Network Status	lsh>st net
	uptime	System Uptime	lsh>st uptime
sc	[OP1][OP2]	Session Control	lsh>sc com1 close

- st net

"st net" command displays the current network states of all sessions.

```
st net
proto name local address peer address sendq state
-----
TCP tty 10.6.0.12( 23) 10.6.0.56(58289) 140 ESTABLISHED
TCP http7 10.6.0.12( 80) 0.0.0.0( 0) 0 LISTEN
TCP http6 10.6.0.12( 80) 0.0.0.0( 0) 0 LISTEN
TCP http5 10.6.0.12( 80) 0.0.0.0( 0) 0 LISTEN
TCP http4 10.6.0.12( 80) 0.0.0.0( 0) 0 LISTEN
TCP http3 10.6.0.12( 80) 0.0.0.0( 0) 0 LISTEN
TCP http2 10.6.0.12( 80) 0.0.0.0( 0) 0 LISTEN
TCP http1 10.6.0.12( 80) 0.0.0.0( 0) 0 LISTEN
TCP http0 10.6.0.12( 80) 0.0.0.0( 0) 0 LISTEN
TCP mbus0 10.6.0.12( 502) 0.0.0.0( 0) 0 LISTEN
TCP com1 10.6.0.12( 1470) 0.0.0.0( 0) 0 LISTEN
lsh>
```

Figure 6-6 "ST NET command"

- st uptime

"st uptime" command shows amount of time since H12 has booted up.

```
st uptime
00:02:39.56 up 0 days
lsh>
```

Figure 6-7 "ST UPTIME" command

- sc

"sc" command is used when users close a session. [OP1] means the name of session, and [OP2] should be "CLOSE".

```
sc mbus0 close
mbus0: closed
lsh>
```

Figure 6-8 "sc" command

☞ *In the case of the "sc" command you should use only small letters.*

### 6.3.2 Checking status by ezManager

Status of the CIE-H12 can be monitored by [Status] button on ezManager. By using the [Refresh Every 1 Second] option in the status window, the status is automatically updated in every second.

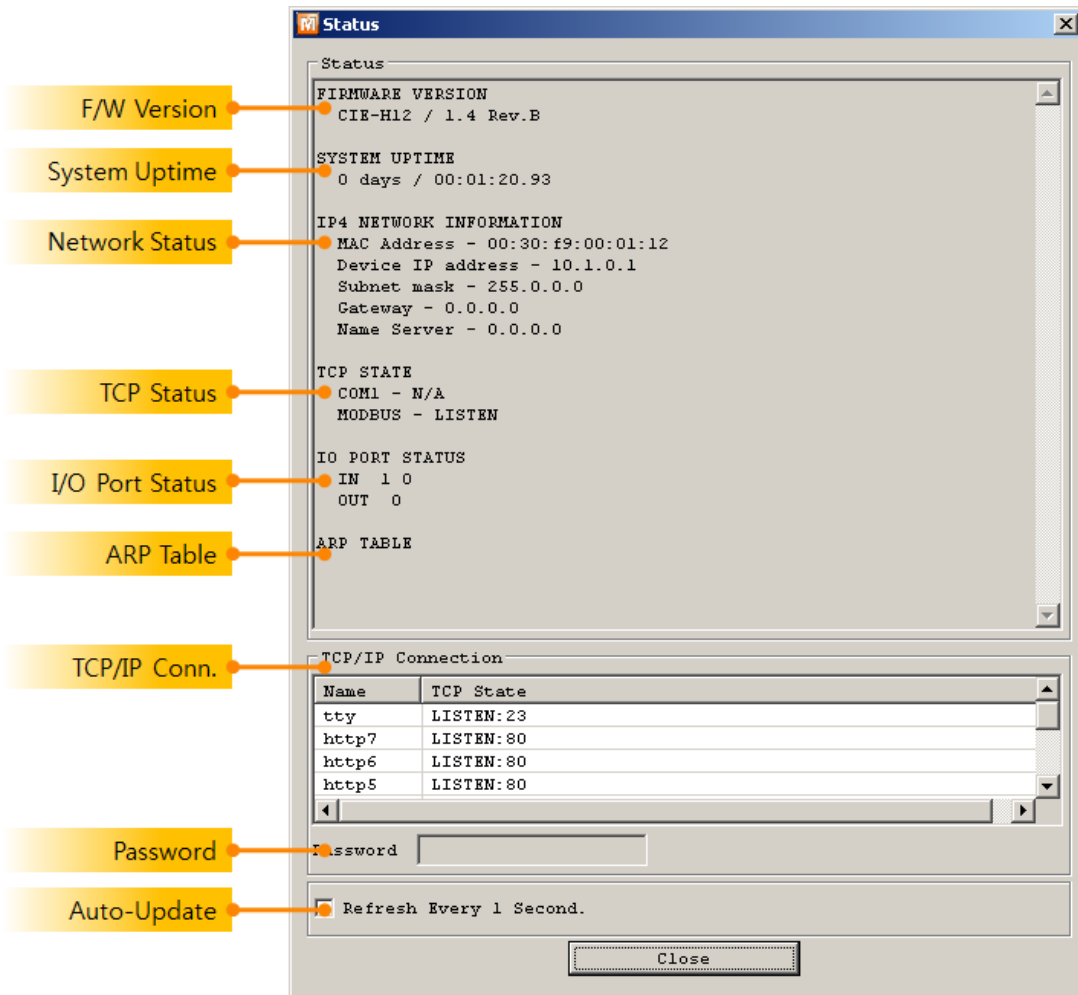

Figure 6-9 status window of ezManager

- **FIRMWARE VERSION**  
The name of model name and the version of firmware are displayed here.
- **SYSTEM UPTIME**  
Amount of time is displayed since the CIE-H12 boots up.
- **IP4 NETWORK INFORMATION**  
All information about related items with IP Address including the MAC address is shown here. It works even if the IP address is assigned from DHCP.

- TCP STATE

TCP status of each port is shown in this section.

Table 6-2 TCP STATE

message	description
LISTEN	waiting for requests of a TCP connection
CLOSE	a TCP connection is closed
SYN_SENT	send "SYN" segment to make a TCP connection
ESTABLISHED	When a TCP connection is established
N/A	Not Available

- I/O PORT STATUS

This represents I/O ports' status. '1' means HIGH(ON) and '0' means LOW(OFF).

- ARP TABLE

This part shows ARP table on the CIE-H12. When a TCP connection is established or UDP data communication is performed, the information of IP and MAC address is automatically stored in the ARP table. This information is held for 1 minute. If there is no data communication for 1 minute, the information will be removed.

- TCP/IP Connection

In this section, the same information with TCP STATE is displayed with IP address and port number. A difference is that users can terminate a TCP connection. When right click on a session, a small pop-up window is created.

- Password

This text box is activated when the CIE-H12 has a password. If users want to close the TCP connection, this password has to be correctly filled.

- Refresh Every 1 Second.

If this option is checked, ezManager sends query in every second.

### 6.3.3 Debugging Message

By using [Debugging] option, users can receive debugging messages from the CIE-H12 on the network.

☞ *When you are facing a problem about the TCP connection or data communication, please use this function and send us the stored file. We can use it for finding out the reason of your problem.*

☞ *Debugging messages are broadcasted to entire network via UDP so it might cause serious network traffic. Remember you should turn the option off after using it.*

- Setting debugging option

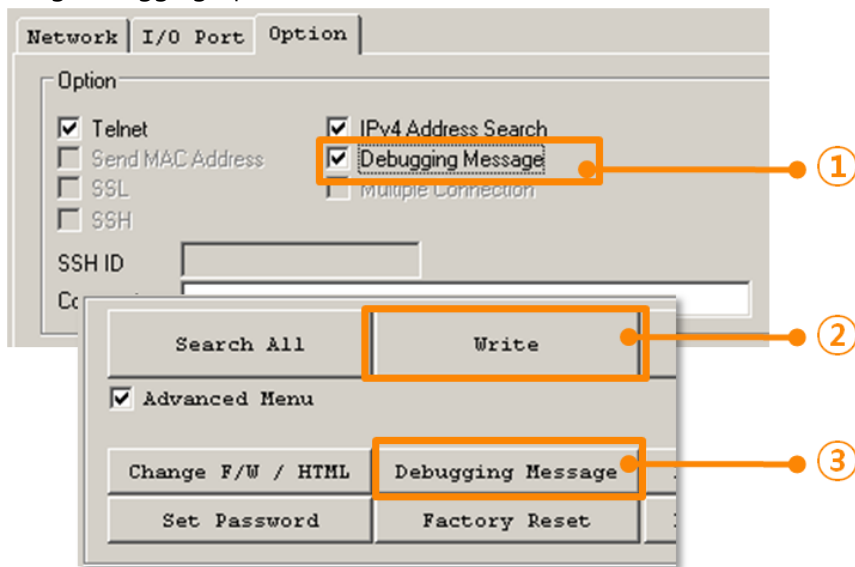

Figure 6-10 setting debugging option

- ① Check the [Debugging Message] option
- ② Press the [Write] button
- ③ After check the [Advanced Menu], click the [Debugging Message] button. And then, the debugging message window is shown on your screen like the figure below.

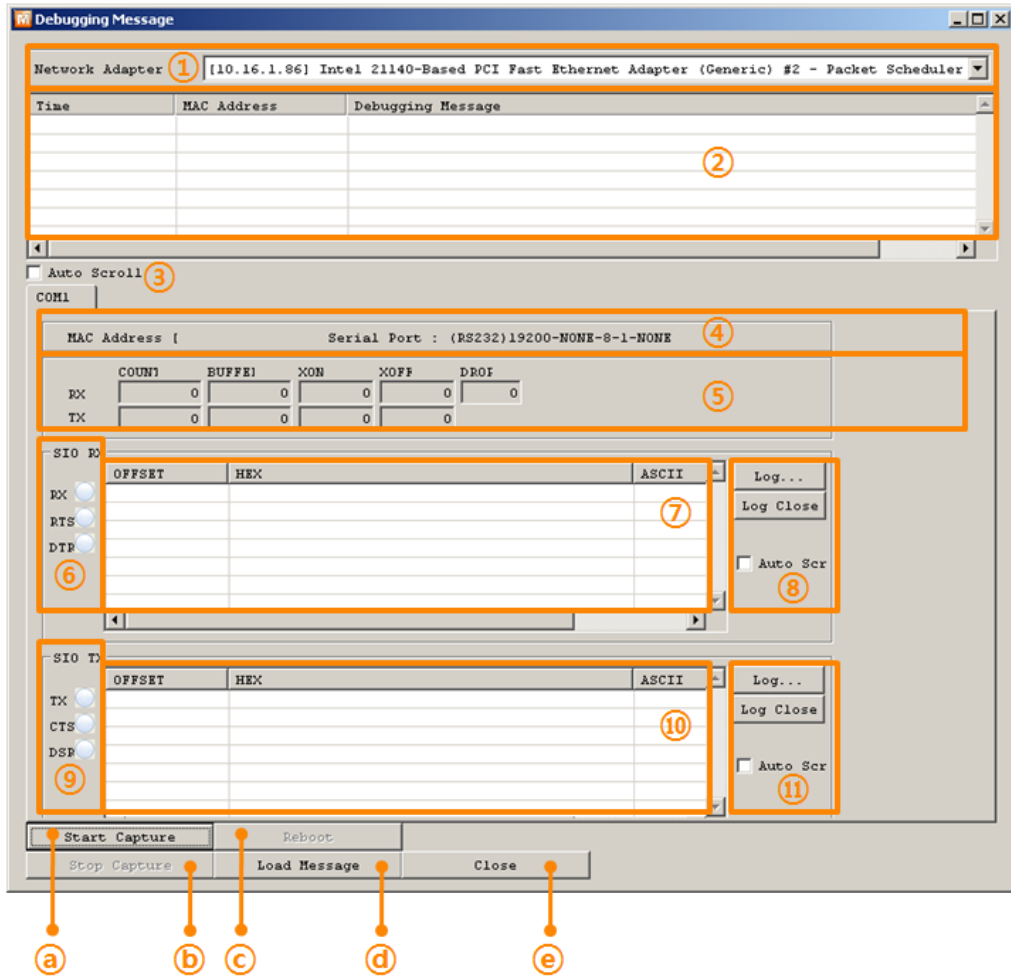

Figure 6-11 debugging message window

- ① Pull down menu for selecting a network adapter
- ② Place for showing received debugging messages from the CIE-H12 over the network
- ③ Auto update to display the latest captured file on the screen of ②
- ④ MAC Address Information of a selected message
- ⑤ ~ ⑪ Unavailable
- a) To start capturing debugging messages from the CIE-H12
- b) To stop capturing debugging messages from the CIE-H12
- c) Unavailable
- d) [Load Message] is for loading a debugging log file to display
- e) Closing debugging message window

## 7 Additional Functions

### 7.1 Security

#### 7.1.1 Restriction of Access (ezTCP Firewall)

On the [Option] tab of ezManager, users can set restriction of access function with filtering MAC and IP address.

- Allowed MAC Address

If this option has a value of MAC address, the device which has the MAC address is only permitted to access.

- Allowed IP Address

This is for qualifying hosts with IP address or range of IP address. The range is defined by multiplying [IP address] and [Network Mask] in bit unit.

- Examples

Table 7-1 examples of defining allowed IP range

IP address	network mask	allowed IP address range
10.1.0.1	255.0.0.0	10.1.0.1 ~ 10.255.255.254
10.1.0.1	255.255.255.0	10.1.0.1 ~ 10.1.0.254
192.168.1.4	255.255.255.255	192.168.1.4

- Apply to ezManager

[Apply to ezManager] is for applying above two restrictions to ezManager functions like [Search], [Read], [Write] and etc.

#### 7.1.2 Setting Password

A password can be used for protecting the CIE-H12 from TELNET login or changing environmental parameters by hosts which are not qualified. The maximum length is 8 bytes of Alphabet or number.

☞ *When you want to revoke all of these restrictions, change the mode of the CIE-H12 to the ISP mode. All restrictions are removable and communication with ezManager is revoked in the ISP mode.*

### 7.1.3 Valid Time

The CIE-H12 only recognizes signals of the input ports as the valid signals when the signal lasts for the [Valid Time]. If the signals are not maintained during the [Valid Time], the input signals will be ignored. The unit used for the [Valid Time] is 1ms. However, because the accuracy is only guaranteed in 10ms, the designated values are rounded down in units of 10ms.

### 7.1.4 Delay

The CIE-H12 gives output values to the output ports after the amount of time has set in the [Delay]. If users set the value of [Delay] to 0, the CIE-H12 gives the output value to the output port immediately. The unit used for the [Delay] is 1ms. However, because the accuracy is only guaranteed in 10ms, the designated values are rounded down in units of 10ms.

☞ *If the timer for the [Delay] is already running, all the subsequent orders for giving signals to the output ports are ignored.*



## 7.2 Option Tab Functions

### 7.2.1 Notify IP Change

The CIE-H12 can be a TCP server even though it is assigned the IP address automatically. Using [Notify IP Change] function, it sends its IP address with the host name to the specific server. There are 3 types (DDNS, TCP and UDP) of functions provided.

- Dynamic Domain Name Service (DDNS)

The CIE-H12 supports DDNS function offered by DynDNS to manage its changed IP address as a host name. Therefore, you have to make an account and create host names on the website of DynDNS before use this.

☞ All about service usage of an account could be changed according to the policy of DynDNS.

☞ Homepage of DynDNS: <http://dyn.com/dns/>

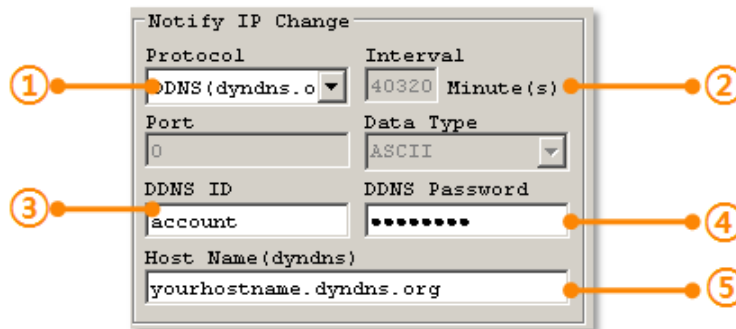

Figure 7-1 setting DDNS

- ① Select the [DDNS (dyndns.org)] item.
- ② 40,320 is a fixed value.
- ③ Input the ID of DDNS account.
- ④ Input the password of the account.
- ⑤ Input one of the host names which you created on your account.

- TCP/UDP

In case you have an own server and want to manage the information about changed IP addresses, you are allowed to use TCP/UDP for using this option. The [Data Type] can be selected as ASCII or hexadecimal, and the [Interval] is available on configuration.

☞ For more information about this, please refer to the "Notify IP Change" on the [Support] >> [Download] >> [Technical Document] menu of our web site.

## 8 Self-Test in Trouble

When users are in trouble with the CIE-H12, make sure of the following steps first.

### 8.1 Searching problem with ezManager

- Confirming types of configuration utility  
The CIE-H12 can be configured by ezManager.
- Cancelling the Firewall operation  
In case of being blocked by firewalls of personal computer or network block, you must cancel all the firewalls before searching the CIE-H12.

☞ *Most of vaccine programs have firewall functions so it can cause some trouble to search the CIE-H12. Close or pause these programs before searching the products.*

- Stable supply of the power  
Check if the power is supplied continually. If the power is constantly supplied, the LED on the CIE-H12's body blinks slowly.
- Connection with the network  
Make sure that the network connection is fine including Ethernet cable. In this step, we recommend that users connect the CIE-H12 with PC directly or in the same network hub.
- Checking options of restriction  
In case that restriction of access is activated, the communication with ezManager will be unavailable. When users are in this situation, make the CIE-H12 operate in ISP mode.

## 8.2 Connection Problem over Modbus/TCP

- Checking parameters related with TCP/IP

When the CIE-H12 has a private network IP address, personal computer's IP address has to be the same sub network. Check if the IP address and local port number are correct. In case of a fixed IP address, the subnet mask, gateway IP address and DNS IP address should be configured.

Table 8-1 major parameters related with Modbus/TCP

Slave or Master
Local IP Address, the connection mode (Active / Passive), Peer Address and Peer Port, Subnet Mask, Gateway IP Address, DNS IP Address, DDNS option and etc.

- PING Test

Confirm the connection over the network by PING test. If the CIE-H12 doesn't send any reply from the request, check the network environment.

- Firewall

In case the networks which need strong security, the access may be denied by their firewall. Under this circumstance, users should ask the person in charge of their network to release ports which will be used. (Ex: TCP 502, UDP 50005)

- Operation Mode

A TCP connection is not possible when the CIE-H12 is operating in the ISP or Serial Configuration mode.

- Connection Mode

To make a TCP connection, both a server (passive mode) and a client (active mode) should exist. If there are only servers or clients, The TCP connection can't be established.

- ezTCP Firewall

When users set the ezTCP firewall with MAC and IP address, any hosts can't be reachable to it except for the hosts which have the allowed MAC and IP address. Inactivate the option or check the setting is correct.

- Checking the TCP status

TCP is a protocol connected one to one without multiple connections function except for using the Multiple-connection. Because of this, if a device is on a TCP connection, other requests are denied. If users are in this situation, check the network status by connecting on TELNET or using ezManager.

### 8.3 Communication Problem over Modbus/TCP

- Checking Modbus/TCP parameters  
Check all the related parameters that [Unit ID], [Input Port Base Address], [Output Port Base Address], [Poll Interval] and [Notify Input change].
- Checking which mode is using  
In case of MACRO or serialized Modbus/TCP, you can control the outputs of the CIE-H12. Turn the mode off if those modes are using.

☞ *Contact us if you have any questions about above steps or our products.*



## 9 Technical Support, Warranty, and Precaution

### 9.1 Technical Support

If you have any question regarding operation of the product, visit Customer Support FAQ corner and the message board on Sollae Systems' web site or send us an email at the following address:

- E-mail: [support@eztcp.com](mailto:support@eztcp.com)
- Website Address for Customer Support: <http://www.eztcp.com/en/support/>

### 9.2 Warranty

#### 9.2.1 Refund

Upon the customer's request to refund the product within two weeks after purchase, Sollae Systems will refund the product.

#### 9.2.2 Free Repair Services

For product failures occurring within two years after purchase, Sollae Systems provides free repair services or exchange the product. However, if the product failure is due to user's fault, repair service fees will be charged or the product will be replaced at user's expense.

#### 9.2.3 Charged Repair Services

For product failures occurring after the warranty period (two years) or resulting from user's fault, repair service fees will be charged and the product will be replaced at user's expense.



### 9.3 Precaution

- Sollae Systems is not responsible for product failures occurring due to user's alteration of the product.
- Specifications of the product are subject to change without prior notice for performance improvement.
- Sollae Systems does not guarantee successful operation of the product if the product was used under conditions deviating from the product specifications.
- Reverse engineering of firmware and applications provided by Sollae Systems is prohibited.
- Use of firmware and applications provided by Sollae Systems for purposes other than those for which they were designed is prohibited.
- Do not use the product in an extremely cold or hot place or in a place where vibration is severe.
- Do not use the product in an environment in which humidity is high or a lot of oil exists.
- Do not use the product where there is caustic or combustible gas.
- Sollae Systems does not guarantee normal operation of the product under the conditions a lot of noise exists.
- Do not use the product for a purpose that requires exceptional quality and reliability relating to user's injuries or accidents – aerospace, aviation, health care, nuclear power, transportation, and safety purposes.
- Sollae Systems is not responsible for any accident or damage occurring while using the product.



## 10 History

Data	Version	Comments	Author
2011.08.01	1.0	○ Initial release	Roy LEE
2011.08.02	1.1	○ Product's picture has been replaced.	Roy LEE
2011.08.04	1.2	○ Gap of the output port has been corrected.	Roy LEE
2011.12.22	1.3	○ Descriptions of DynDNS service has been changed.	Amy Kim
2012.04.25	1.4	○ Descriptions regarding recommendation for a high capacity relay has been added	Amy Kim
2012.06.26	1.5	○ Change description of network interface ○ Remove description about PPPoE and DHCP ○ Extend the warranty period to two years	Amy Kim
2013.02.07	1.6	○ Change voltage conditions of output port	Amy Kim