

User's Manual

P520



Part Number.980312-001

Rev.A

© Zebra Technologies Corporation

FOREWORD

This manual contains installation and operation information for the Eltron P520 Series card printers manufactured by Zebra Technologies Corporation.

RETURN MATERIALS AUTHORIZATION

Before returning any equipment to Zebra Technologies Corporation for in-warranty or out-of-warranty repair, contact Repair Administration for a Return Materials Authorization (RMA) number. Repack the equipment in the original packing material and mark the RMA number clearly on the outside. Ship the equipment, freight prepaid, to the address listed below:

For USA and Latin America:
Zebra Technologies Corporation
Eltron Card Printer Products
1001 Flynn Road
Camarillo, CA. 93021-8706.USA
Phone: +1 (805) 579-1800
FAX: +1 (805) 579-1808

For Europe, Asia and Pacific:
Zebra Technologies Inc. France
Eltron Card Printer Products
Zone Industrielle, Rue d'Amsterdam
44370 Varades, France
Phone: + 33 (0) 240 097 070
FAX: + 33 (0) 240 834 745

COPYRIGHT NOTICE

This document contains information proprietary to Zebra Technologies Corporation. This document and the information contained within are Copyrighted by Zebra Technologies Corporation and may not be duplicated in full or in part by any person without written approval from Zebra. While every effort has been made to keep the information contained within current and accurate as of the date of publication, no guarantee is given that the document is error-free or that it is accurate with regard to any specification. Zebra reserves the right to make changes, for the purpose of product improvement, at any time.

TRADEMARKS

P520 is a service mark and Eltron is a registered trademark of Zebra Technologies Corporation. Windows and MS.DOS are registered trademarks of Microsoft Corp. All other trademarks or registered trademarks are marks of their respective holders.



WARRANTY INFORMATION

WE NEED TO HEAR FROM YOU!

To establish your warranty period and provide access to technical support, send us your warranty registration card today!

Zebra warrants the mechanism, control electronics and power supply, under normal use and service, to be free from defects in material and workmanship for a period of twelve (12) months from the date of purchase by the end user. If proof of purchase or product registration cannot be established, shipment date to the original buyer (dealer or distributor) will be used to establish the warranty period.

Failure to exercise caution to protect the equipment from electrostatic discharge damage, adverse temperature and humidity conditions or physical abuse, including, but not limited to, improper packaging, shipping, service or repairs performed by personnel not authorized by Zebra may void the warranty. Zebra will, as its option, repair or replace the equipment or any parts which are determined to be defective within this warranty period, and which are returned to Zebra.

The warranty set forth above is exclusive and no other warranty, whether written or oral, is expressed or implied. Zebra specifically disclaims the implied warranties of merchantability and fitness for a particular purpose.

DECLARATIONS OF CONFORMITY



European Council Directive		Compliance to Standards	
89/336/EEC modified by 92/31/EEC and 93/68/EEC	EMC Directive	EN 55022-B	RF Emissions control
	EMC Directive	EN 500082-1,1992	Immunity to Electromagnetic Disturbances
73/23/EEC modified by 93/68/EEC	Low voltage Directive	EN 60950	Product safety



Model: P520 conforms to the following specification:
FCC Part 15, Subpart A, Section 15.107(a) and Section 15.109(a)
Class A digital device

Supplemental Information:

This device complies with Part 15 of the FCC Rules. Operation is subject to the following two conditions: (1) This device may not cause harmful interference, and (2) this device must accept any interference received, including interference that may cause undesired operation.

Note:

This equipment has been tested and found to comply with the limits for a class A digital device, pursuant to Part 15 of the FCC Rules. These limits are designed to provide reasonable protection against harmful interference when the equipment is operated in a commercial environment. This equipment generates, uses, and can radiate radio frequency energy and, if not installed and used in accordance with the instruction manual, may cause harmful interference to radio communications. Operation of this equipment in a residential area is likely to cause harmful interference in which case the user will be required to correct the interference at his own expense.



INTRODUCTION

Thank you for choosing the Eltron P520 Plastic Card Printer.

Eltron's P series card printers offer a low cost, high quality solution to those requiring computer-controlled printing and encoding of credit card style plastic cards, Card applications include personalized identification, access control, visitor, membership, badges and tags.

This manual guides you to efficient start up and operation of your new Card Printer.

P520 PRINTER MODELS

The Eltron Product Number tells a story:

Here is a quick review of the Eltron Card Printer Series numbering and lettering system to help you.

The P520 Plastic Card Printer employs Dye Sublimation and Resin Thermal Transfer technologies. Model numbers include identifiers that specify options are shown using the following lettering conventions:

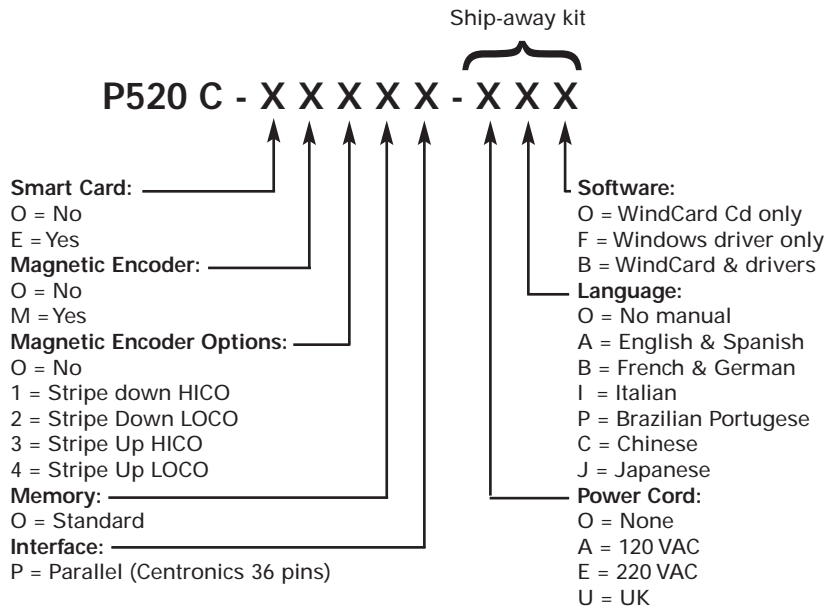

ICONS

Throughout this manual, different icons highlight important information, as follows:



Important general information.



Mechanical hazard, such as one associated with moving parts, capable of resulting in equipment damage or personal injury.



Electrical hazard, such as an exposed voltage point, capable of causing electrical shock and personal injury.



An area where electrostatic discharge (ESD) can cause component damage. Use a grounding wrist band.



Elevated temperature hazard, capable of producing a burn.



Keep Card Printer clean by minimizing cover open time.



TABLE OF CONTENTS

1	GETTING STARTED	1
	1•1 Unpacking your	1
	1•2 Indicators and control	3
	1•3 Printer installation	4
2	OPERATION	5
	2•1 Printer Features	5
	2•2 Loading Printing Ribbons	6
	2•3 Loading Lamination Patch	8
	2•4 Loading cards	9
	A- Card Feeder	9
	B- Card Cleaning Cartridge	10
	C- Card Thickness Control Lever	11
	D- Card Output Hopper	11
	2•5 Reject Card Box	12
	2•6 Feeding one card at a time	14
	2•7 Printing a test card	15
	2•8 Printer menu information	16
3	PRINTING A SAMPLE CARD	21
	3•1 Install Driver on windows 95/98	22
	3•2 Install Driver on windows 2000 & NT4.0	23
	3•3 Set Printer Driver Option	23
	3•4 printing a sample card	24
4	CLEANING	25
	4•1 Cleaning system	26
	4•2 Cleaning the print head	27
	4•3 Cleaning the Laminator rollers	28
	4•4 Card Cleaning cartridge	29
5	TROUBLESHOOTING	31
	5•1 Interpreting LCD Display messages	31
	A- About the Printing Station	31
	B- About the Laminator Station	34
	5•2 Print Quality Issues	35
6	TECHNICAL SPECIFICATIONS	39



APPENDIX A	43
Introduction	43
A- Media Loading orientation	44
B- Magnetic Encoder Cleaning	45
APPENDIX B	46
Introduction	46
A- Media Loading orientation	47
B- Smart Card Contact Station Interface	47
APPENDIX C	48
Ribbons	48
Cards & Patches	50
Accessories	51

GETTING STARTED **1**

1 • 1 Unpacking your card printer

Your P520 printer ships in a carton and protective anti-static bag. Keep all packaging material in case you need to move or re-ship the printer.

While unpacking, inspect the carton to ensure that no damage occurred during shipping.

Please ensure that you have a clean and nearly dust free environment for proper operation and storage of the printer.

In addition to user documentation, make sure the following items are included with your P520 printer:

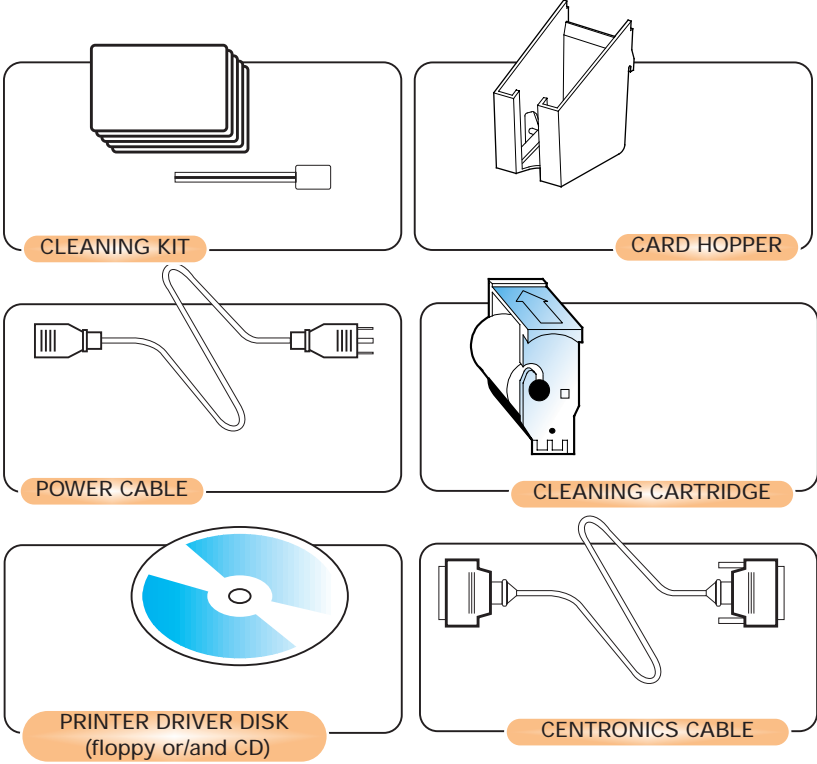

If any items are missing, please contact your dealer. To reorder, please refer to Appendix C of this manual.

1 • 2 Indicators and Control

Your P520 printer has an LCD Display, two LED's and two Panel Buttons.

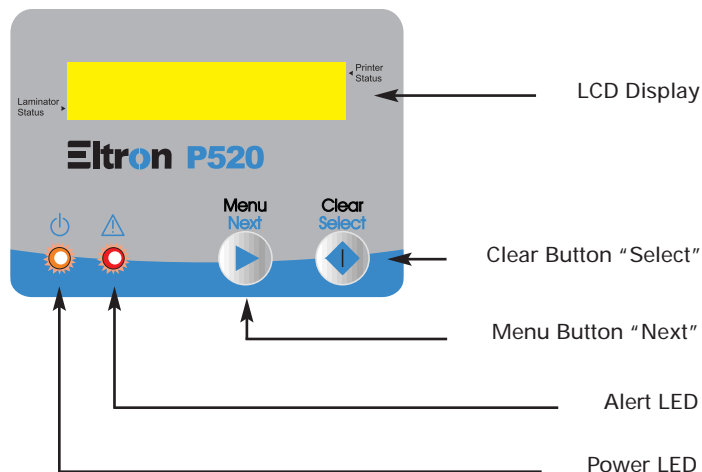

LCD Display:

The 16 character LCD Display is used for:

- Showing the printer's current status
- Providing operator and service messages (chapter 5)

LEDs:

The two LEDs are used for:

- Green: Power LED
- Amber: Alert LED (with Beeper)

Panel Buttons:

The Menu Button (left) is a push button used for:

- Bringing printer into Menu Mode when pressed with the printer showing READY on the LCD Display.
- Using in Menu Mode to scroll through Menu Options.

The Clear Button (right) is a push button used for:

- Clearing an error status (when LCD Display shows an error and Alert LED is on).
- Invoking automatic retry of the operation which gave the error.
- Selecting a Menu Option when in Menu Mode.

Note: The buttons beep when pressed.

1 • 3 Printer Installation

The following will guide you through the installation of your P520 printer.



CAUTION: Limit AC power supplied to the P520 Printer to 110 - 230 V AC, 60 - 50 Hz for an associated 1,40A - 0,80A. Limit excess current draw to 16 amps or less, using an associated circuit breaker or other such device. Never operate the printer in a location where operator, computer, or printer can get wet. Personal injury could result. The printer must be connected to an earthed electrical power supply and properly protected against electrical surges and grounding faults.

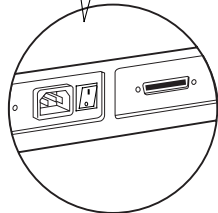
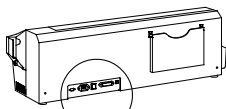

1 • Place the printer in a location that allows easy access to all sides. The printer should never be operated while resting on its side or upside down.

2 • Place the printer's power switch in the OFF (O) position.

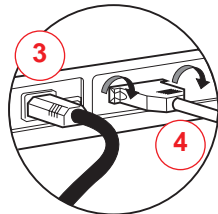

3 • Insert the power cable to the printer power socket and attach to grounded electrical socket of the proper voltage and type.

4 • Attach interface cable to printer and computer and then secure.

5 • Switch power on.



CAUTION: Intermittent or unpredictable operation may occur from unsecured connectors. If damaged, the power cable must be replaced by an exact equivalent. Use only Parallel Cable under 3 Meters in length.

OPERATION 2

2 • 1 Printer Features

The following shows the features found on your P520 Printer:

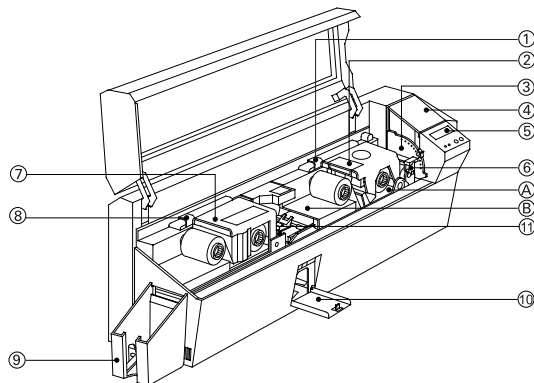

Standard Features:

- 1 • Print Head Unlock Lever
- 2 • Print Head
- 3 • Card Thickness Control Lever
- 4 • Card Feeder
- 5 • LCD Display and two panel Buttons
- 6 • Card Cleaning Cartridge
- 7 • Laminator
- 8 • Laminator Unlock Lever
- 9 • Card Output Hopper
- 10 • Rejected Card Box
- 11 • Cleaning Roller

Optional Features:

- A • Smart Card Contact Station
- B • Magnetic Encoder Station

2 • 2 Loading Printing Ribbons

The P520 Printer requires approved ribbons (see Appendix C). The Resin Thermal Transfer and Dye Sublimation ribbons and Lamination are specifically designed for your P520 Printer. For optimum performance and printer life (Print Head), always use approved ribbons.



DO NOT TOUCH the print head or the electronic components on the print head carriage. Discharges of electrostatic charge from the human body or other surfaces can damage the print head or other electronic components used in this device.

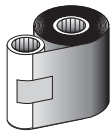

1 • Remove ribbon from packaging.

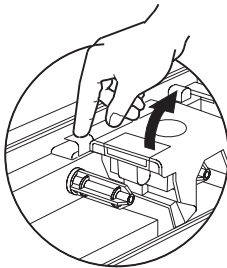
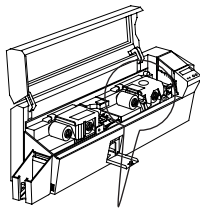

2 • With printer power ON and Printer Ready status, open cover and press down on the Print Head Unlock Lever to open the print head carriage. The print head carriage will pop open.

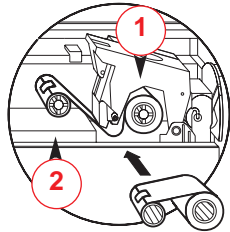

3 • Load ribbon onto the supply spindle "1" (under print head carriage) and empty core (with tape attached) onto the take-up spindle "2". Make sure the ribbon comes off the top of the supply spindle and feeds to the top of the take-up spindle.

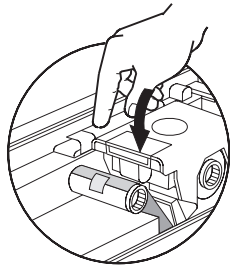

4 • Push down on the Print Head Lock Lever until an audible "click" signals the locked-down position.

5 • Close Cover



Please note that the ribbon automatically synchronises whenever the print head lock down occurs.



The card flipper will not operate and an error will be indicated if you try to flip a card when the cover is open.

2 • 3 Loading Lamination Patch

The P520 Printer requires approved patches (see Appendix C). Clear patches, hologram patches or Overlay varnishes are specifically designed for your P520 Printer. For optimum performance and printer life (Laminator), always use approved patches.

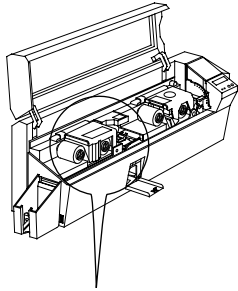

1 • Remove patch from packaging.

2 • With printer power ON and printer Ready status, open cover.

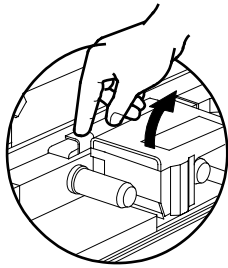

3 • Press down on the Laminator Unlock Lever to open the laminator bracket. The laminator bracket will pop open.

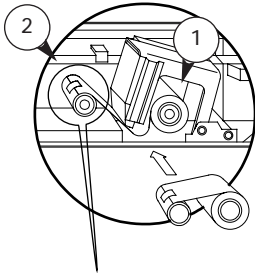

4 • Load patch onto the supply spindle "1" (under laminator bracket) and align the notch of the empty core with the spindle screw (with tape attached) onto the take-up spindle "2". Make sure the patch comes off the top of the supply spindle and feeds to the top of the take-up spindle.

5 • Push down on the Laminator Lock Lever until an audible "click" signals the locked-down position.

6 • Close Cover

.Please note that the ribbon automatically synchronises whenever the laminator head lock down occurs.

2 • 4 Loading Cards

To help you load, print, and collect cards, the P520 has the following items:

A - CARD FEEDER

This items is used for loading cards.

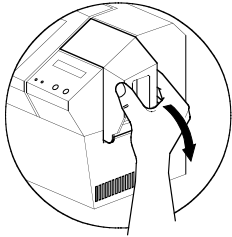

- 1 • Open Card Feeder Cover by putting your fingers on both sides and rotating the cover in a clockwise direction to the open position.

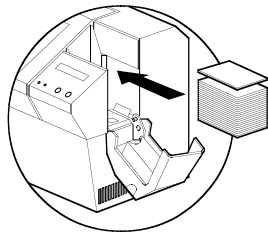

- 2 • Install cards into Feeder* as shown.

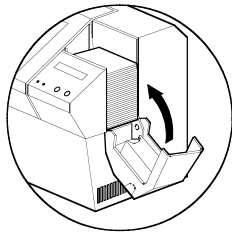

- 3 • Close Card Feeder Cover.



DO NOT bend cards or touch print surfaces as this can reduce print quality. The surface of the cards must remain clean and dust free. Always store cards in an enclosed container. Ideally, use cards as soon as possible. If cards stick together, carefully shuffle them.

* See Chapter 6, Technical Specifications, for card requirements and capacities.

B - INSTALL CARD CLEANING CARTRIDGE

This item is used to clean the cards entering the printer.
It must be installed before using the printer.

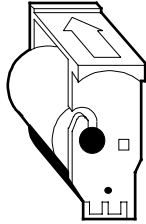

1 • Remove Card Cleaning Cartridge from plastic bag and peel off protective wrapper from adhesive cleaning roller.

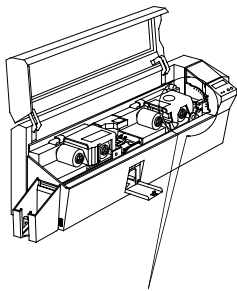

2 • Open printer cover and remove the yellow reminder tape from the location for the Cleaning Cartridge.

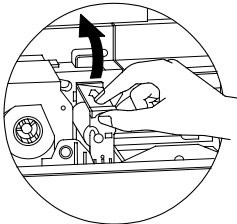

3 • Make sure the arrow on top of the assembly is facing towards the rear of the printer. Hook assembly into slot on printer and rotate down. Ensure the assembly locks in place.

C - CARD THICKNESS CONTROL LEVER

This items is operated by the user to prevent more than one card feeding into the printer at the same time and causing a jam.

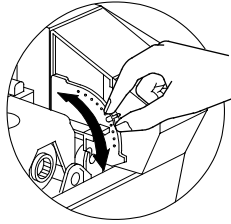

Open cover, and adjust lever to the correct position for the card thickness you are using. Repeat for different card thickness. (Factory setting is for 30 mil (0,762 mm) card thickness). See diagram below:

Card thickness:

A - 60mil (1.524mm) to 50mil (1.27mm)

B - 40mil (1.016mm)

C - 30mil (0.762mm)

D - 20mil (0.508mm)

E* - Less than 20mil (0.508mm)

*Start at lowest position and move lever up to match card thickness.

For other card thickness, start lever at lowest position and move up until cards feed.

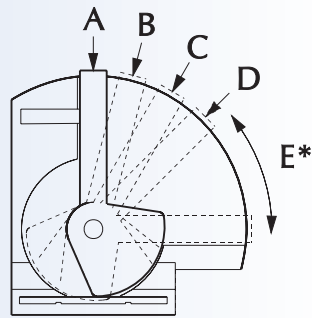

Note: For Lamination cards should only be 30 mil cards, and composite PVC is preferred

D - CARD OUTPUT HOPPER

This items is used for printing cards.

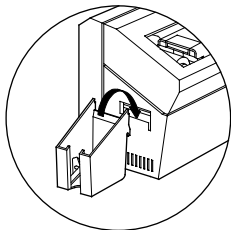

Install card Output hopper onto printer by hooking over bottom edge of card exit aperture.

2 • 5 Rejected Card Box

The P520 Printer is equipped with a Rejected card Box. When an encoding can not be completed, the card is ejected into the Rejected Card Box. The P520 Printer counts the number of cards which go into the Reject Card Box. After 20 cards the printer stops, the Amber LED Flashes and a LCD Message is displayed indicating the need to empty the reject box.

REJECT BOX FULL

WHEN TO MAINTAIN

When the LCD screen reports message

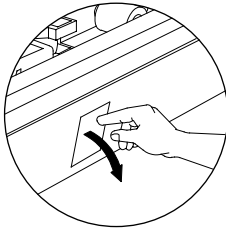

HOW TO MAINTAIN

1 • Press the top of the Rejected Card Box Door as shown. Allow the door to swing down and open.

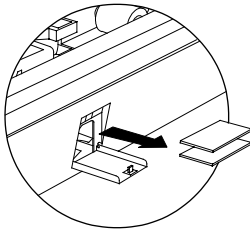

2 • Remove all cards from the Rejected Card Box.

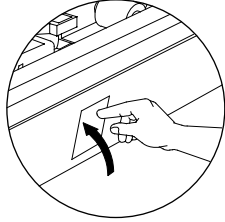

3 • Swing the Rejected Card Box Door and press the top. An audible “click” signals the locked position.

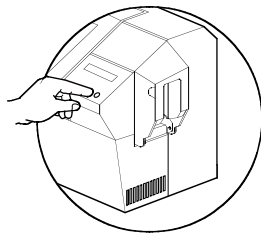

4 • Press the Clear Button on the front panel to re-start the current printer job and to clear the rejected cards counter.

2 • 6 Feeding one card at a time

A Manual Feed Slot is available on the side of the Card Feeder cover for feeding single cards. Cleaning Cards are fed manually through this slot.
The Feeder must be empty for manual card feeding to work properly.

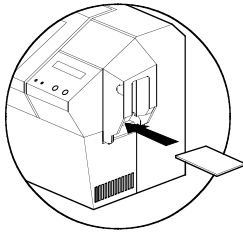

For one-at-a-time printing, feed cards through slot on side of Feeder.

Do not feed more than one card at a time.

2 • 7 Printing a Test Card

With ribbon and cards loaded, your P520 printer is ready to print. To check the operation of the printer and the laminator you should print a test card.

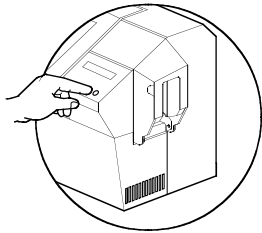

1 • When the printer displays READY, press the "Next" button (left) on your Control Panel to MENU PRINTER, then the "Select" button (right) to PRINTER INFO.

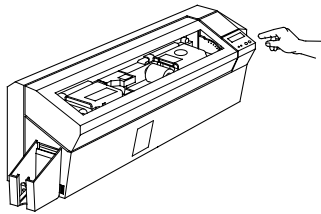

2 • Press twice the "Next" button to SELF TEST MENU and then "Select" to TEST PATTERN.

3 • A test card will print after a few seconds. LCD display will show printing status. Test Card is printed on both sides of the card.

This is an example of the test card.

Front Side: Printer Operation

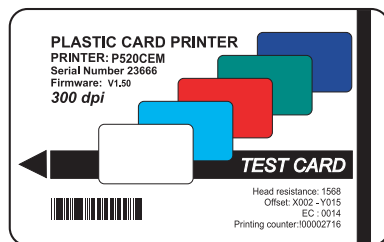

Back Side: Laminator Operation

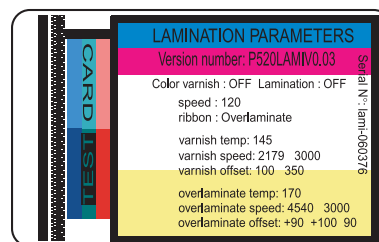

2 • 8 Printer Menu Information

The printer is equipped with an LCD Display and two key buttons which gives access to printer menus.

When the printer status shows READY, press the Menu button to enter the Menu Mode

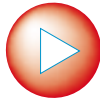

Menu Button "NEXT"(left)

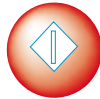

Clear Button "SELECT"(right)

When you are in Menu Mode the top line display shows menu information and the second line of display clarifies the function of the two "NEXT" and "SELECT" key buttons relative to the current menu item. The printer will return to READY Mode if either of the two key Buttons is not pressed within ten seconds of entering Menu mode.

PRINTING STATION:

- PRINTER INFO
- CLEANING MENU
- SELF TEST MENU
- PRINTER DEFAULTS

LAMINATOR STATION:

- LAMINATOR INFO
- SELF TEST MENU
- LAM DEFAULTS

See next page:

P520 LCD Menu Tree: Printing Station

*If the printer is equipped with a Magnetic Stripe Encoder

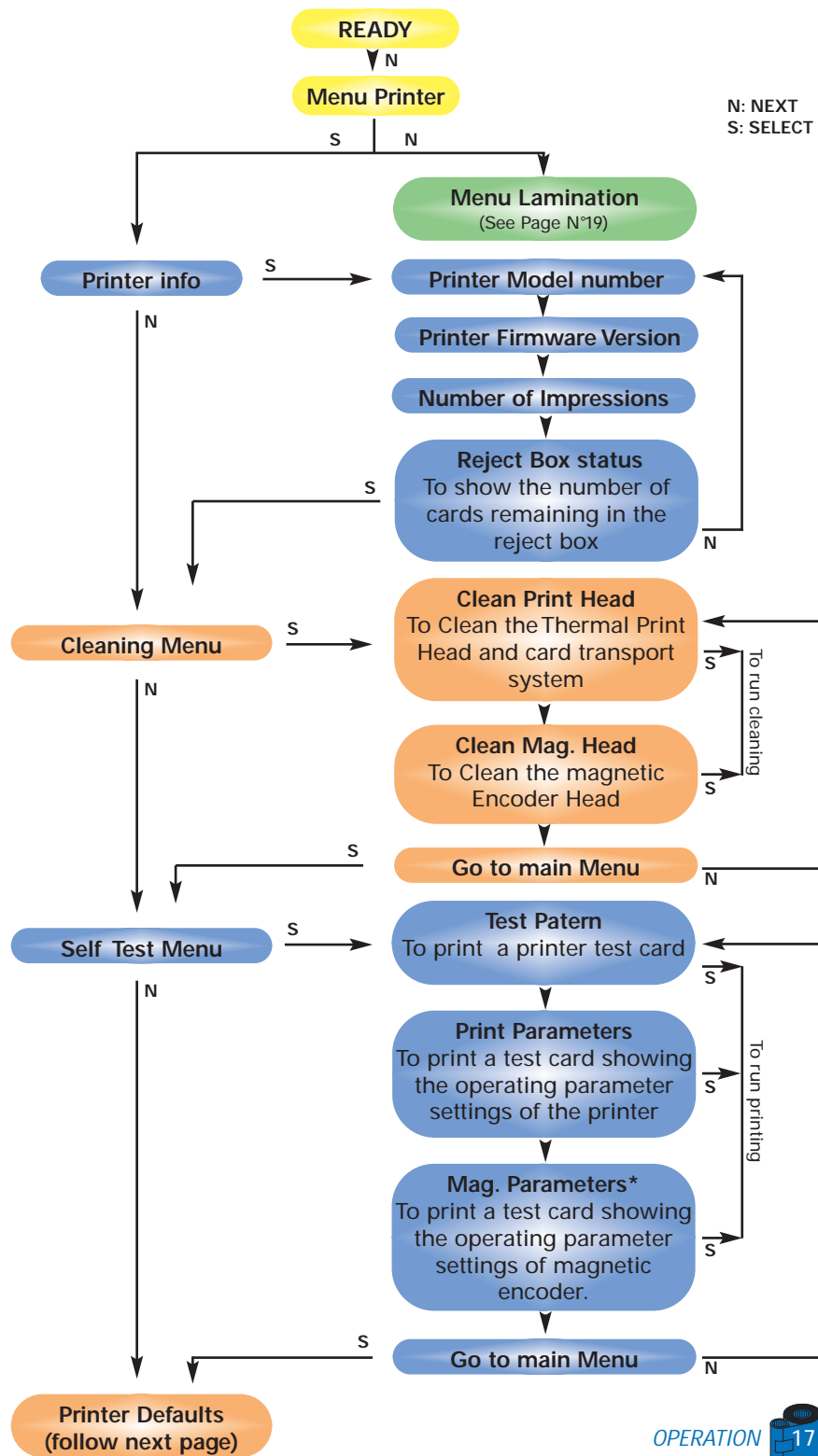

Menu Tree: Printing station (continuation)

N: NEXT
S: SELECT

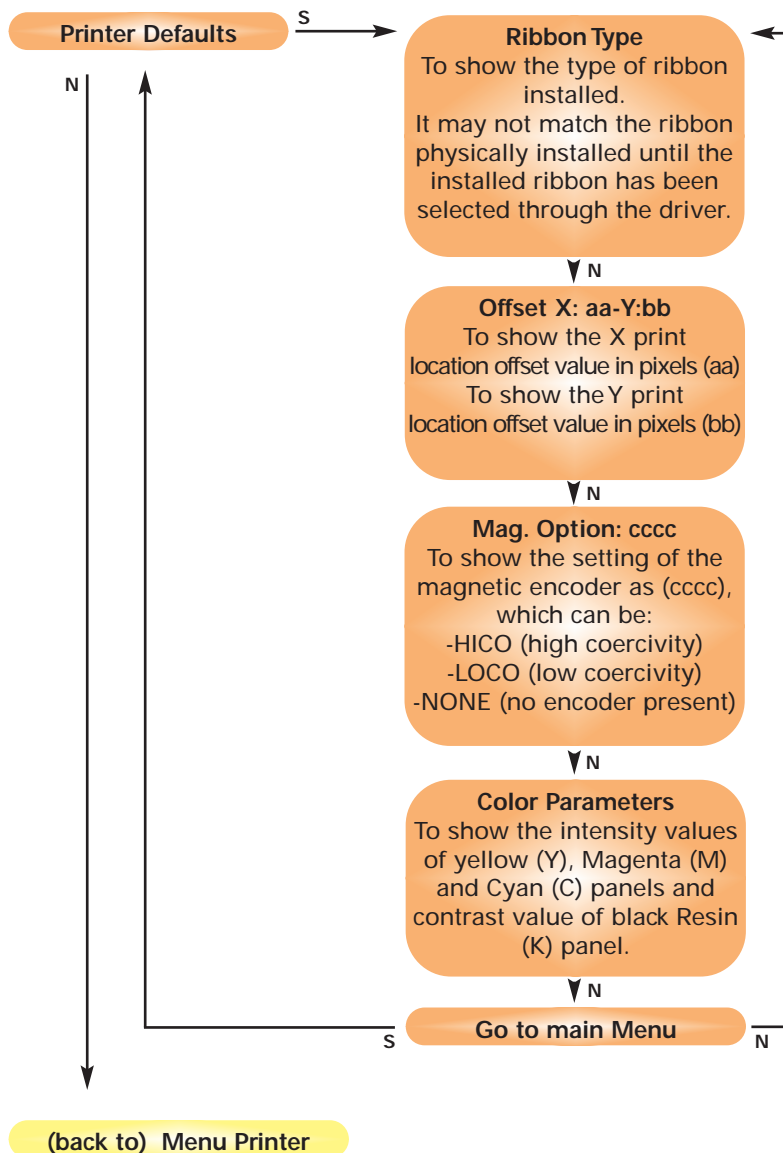

Menu Tree: Lamination station

N: NEXT
S: SELECT

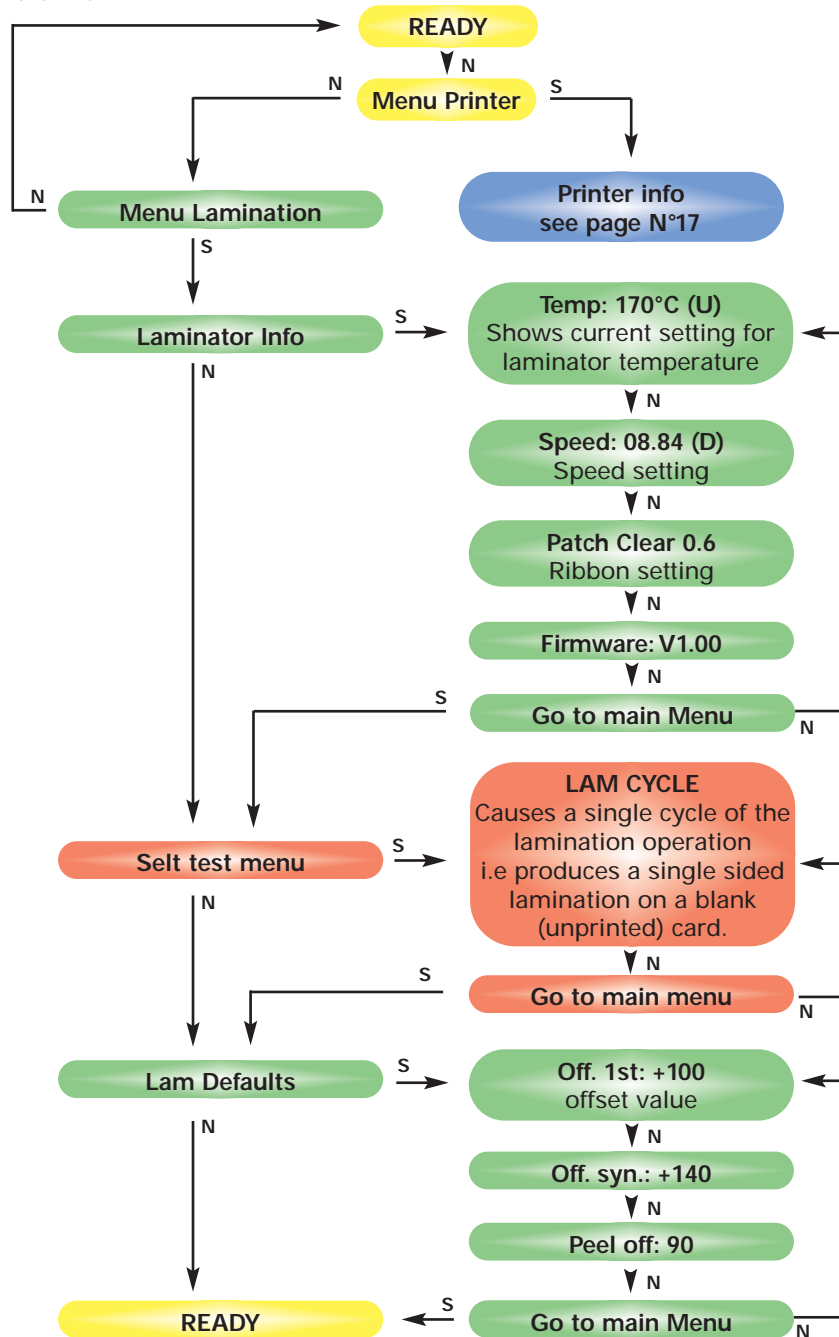

P **PRINTING A SAMPLE CARD**

Printing with the P520 Printer requires the Windows Printer Driver, your card design/issuing software or printer command level programming through the printer interface.

The P520 Card Printer can be used with any Windows 95/98 or Windows NT 4.0 software application program, using the drivers provided with the printer.

This section contains information on the printing of a dual-sided card in color (using the 6-Panel color ribbon YMCKOK) and the Windows Printer Driver.



BEFORE installing updated printer driver versions, always delete the existing printer driver version from your computer.

3 • 1 To install the P520 Printer Driver in windows 95/98, use the following steps:



IMPORTANT NOTE: Ensure that your PC printer port is set to standard mode and also ensure that you have deleted any previous versions of this printer driver. If you have any doubts please contact your IT department.

This installation uses floppy drive "A" or from CD Rom as the installation drive with the printer used as stand alone.

- Start your computer and then Windows.
- Insert your "Eltron Software" diskette into the drive "A" or CD drive.
- Under windows click the **Start** button, select **Settings**, then **Printers**.
- Double click on the **Add Printer icon** and also Next.
- Ensure **Local Printer** is selected and click on Next.
- Click on **Have disk** and then type in "**A:\win95**" if using the floppy disc or "**D:\win95**" if using the CD and click OK.
- P520 CARD PRINTER should be displayed after which click on Next.
- Choose **LPT1: Standard Printer Port**, click on **Next**, select **Yes** to set as **Default Printer** and click on **Finish** to install.

The Printer wizard will copy the necessary files to the PC for you and the P520 printer driver installation will be completed.

3 • 2 To install the P520 Printer Driver in windows 2000/NT4.0:



Ensure that you have administrative privileges to perform this installation or contact your IT department.

Set printer as Not Shared for stand alone use.

Use the steps provided for windows 95/98 installation with the exception of step 6. Where you must type in "A:\nt40" for NT4.0, "A:\winNT4" for Windows 2000 if using the floppy disc, or "D:\nt40" , "D:\winNT4" if using the CD, instead and click OK.

Once the printer driver has been successfully installed, you will need to configure it for your printer. This driver provides control of several printer features when printing from Windows applications. These features are accessed through the P520 Plastic Card Printer Properties. To access these properties select the P520 Card Printer icon in Printers. Then click File Menu and select Properties.

3 • 3 Set Printer Driver Options:

The P520 Printer screen appears. Change the options as follows:

- On the **Printer** tab configure the magnetic encoder feature. If your Printer is equipped with a Magnetic Encoder option, select **With Magnetic Encoder** option.
- On the **Card** tab select card orientation:
Landscape or portrait - Select "**Landscape**".
- On the **Ribbon** tab, select the Ribbon Type. Select **YMCKOK** for the standard 6-panel ribbon.
- In the same tab, go to Black Panel area and select Text Only. this option allows the text printing using the Black Resin Panel from the Color Ribbon.
- Close the Eltron P520 Printer Properties screen.

Now that you have loaded media and set up the printer driver, the P520 Printer is ready to print.

3 • 4 Printing a sample card:

Follow the steps to print your first card

- Go to the Microsoft Word Software.
- If the printer was not selected as the default printer, go to the **file** menu and Select **Printer** and choose **Eltron P520 Card Printer** in the printer names list. Then Close the print dialog box.
- Come back to **file** menu and choose **Page Setup**.
- Select **Paper Size** tab and in **Paper Size** choose **Card**. Then select the orientation: "landscape".
- Go to **Margins** tab, Set the Top, Bottom, left and right margins to 0 (zero) values.
- Press **OK** to close Page Setup window.
- The card appears on the screen.
- Design a card with 2 sides as follow:

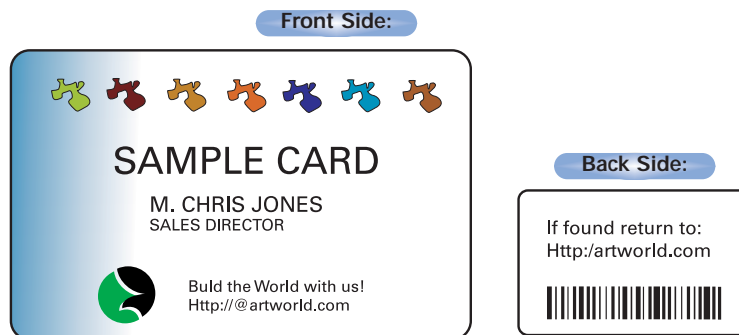

- Once you are ready to print, go to **File** and point **Print**
- The printer will feed in a card and start printing (the data download time will vary depending on the complexity of the card design and the processing speed of the computer).
- Once the printing job is achieved the card is ejected from the printer.

CLEANING 4



PROTECT YOUR FACTORY WARRANTY!

The recommended maintenance procedures must be performed to maintain your factory warranty. Other than the recommended cleaning procedures described in this manual, allow only Zebra authorised technicians to service the P520 Printer.

NEVER loosen, tighten, adjust, or bend, etc. a part or cable inside the printer.

NEVER use a high pressure air compressor to remove particles in the printer.

4 • 1 Cleaning System

Your P520 Printer includes a simple cleaning system using the Pre-Saturated Cleaning Cards provided. The regular use of these cards will clean and maintain important parts of your printer that cannot be reached: including the Print Head, the Lamination station and Transport Rollers.

CLEAN PRINTER

WHEN TO CLEAN

When the LCD screen reports messages.

HOW TO CLEAN

1 • Leave power on.

Open Cover and release Print Head Bracket to remove ribbon.

Close Print Head Bracket

Close Cover. Remove cards from Card Feeder.

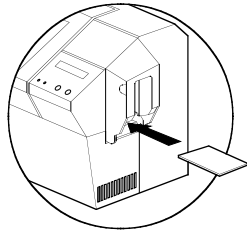

2 • Insert one Pre-Saturated Cleaning Card (provided) through slot on the side of the Card feeder Cover.

3 • Press the right panel button for a few seconds. The card will feed into printer and carry out the cleaning process. Repeat the process with a new Cleaning card if necessary.

Note: For a printer cleaning prior to the WHEN TO CLEAN signal, press the Left Panel button until the LCD screen shows "CLEANING MENU". Press the right Panel button to select and one more time again to run the cleaning process (Repeat first steps 1 & 2 above).



Although the CLEAN PRINTER message is displayed until the cleaning process has been performed, the printer will continue to operate.

4 • 2 Cleaning the Print Head

A cleaning using the cleaning system with cards usually suffices. However, a separate Print head cleaning using swabs can remove more stubborn deposits when print anomalies persist. To avoid deposits, only use foam-tipped swabs.

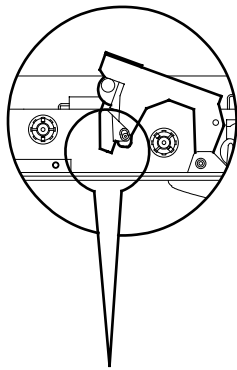

1 • Switch power Off, open cover, raise Print Head and remove the Ribbon.

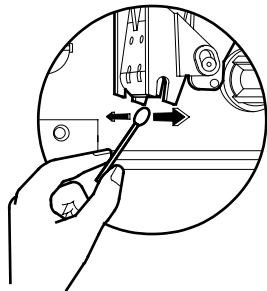

2 • Clean Print Head by moving alcohol-moistened swab tip side-to-side across Print Head elements. Only use moderate force. Make sure the elements are dry before switching on. (To reorder swabs see Appendix C).



Never use a sharp object to scrape deposits from the print head. Permanent damage will result.

4 • 3 Cleaning the Laminator Rollers

A cleaning using the Cleaning System with cards usually suffices, moreover your printer is equipped with two cleaning rollers situated before the card enter the Laminator. The upper roller has a coating that collects any loose particles on the surface of cards. However, a separate Laminator Station cleaning can remove more stubborn deposits.



To avoid deposits, only use foam-tipped swabs. Never touch the rollers with fingers.

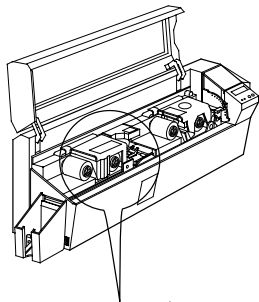

WHEN TO MAINTAIN

Cleaning frequency varies with different environments. Clean when lamination anomalies persist.

HOW TO MAINTAIN

1 • Switch OFF your printer and open cover. Make sure the Laminator rollers cool down.

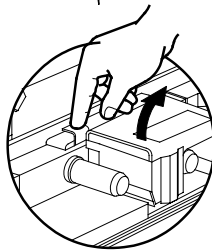

2 • Press down on the unlock lever to open the Laminator braquet.

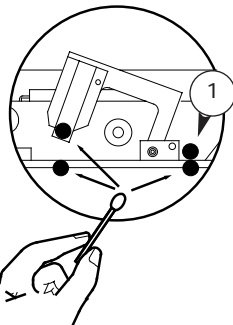

3 • Clean the two Laminator rollers and the two transport rollers gently with a swab. (The above transport roller "1" can be temporary removed for an easy clean)

4 • Make sure the rollers are dry before Pushing down the braquet and switching on your printer.

4 • 4 Card Cleaning Cartridge

Your P520 Printer also has a Card Cleaning Cartridge. This item cleans the cards entering the printer. To ensure print quality, the cleaning roller requires periodic replacements.

CLEAN PRINTER

WHEN TO MAINTAIN

When LCD screen reports message.
Run a printer cleaning first.
(see 4.1 Cleaning System for more instructions).

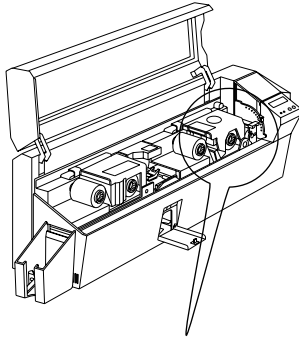

HOW TO MAINTAIN

1 • Open Cover and locate Cleaning Cartridge

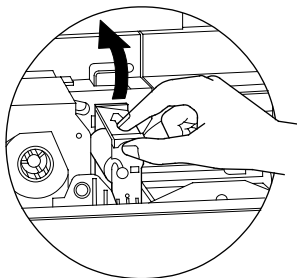

2 • Gently remove Cleaning Cartridge by rotating up and away from printer.

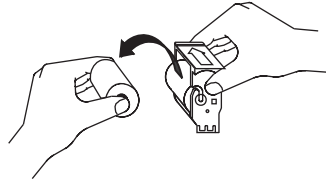

3 • Remove Cleaning Roller from Cartridge and discard.

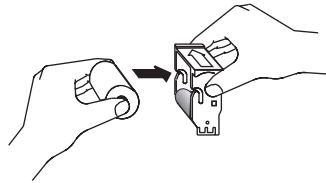

4 • Install new Cleaning Roller into Cartridge*. To avoid contamination, always hold the Cleaning Roller assembly by the ends.

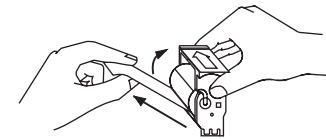

5 • Carefully peel off wrapper from new Cleaning Roller while in Cartridge.

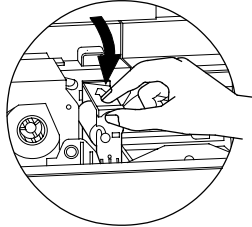

6 • Replace Cartridge into printer. Make sure the arrow on top of the assembly is facing towards the rear of the printer. Hook assembly into slot on printer and rotate down. Ensure the assembly locks in place.

DO NOT touch the roller surface that contacts the cards.

7 • Close Cover

See Appendix C for replacement Cleaning Rollers.



Although the CLEANING PRINTER message is displayed until maintenance has been performed, the printer will continue to operate.

5 TROUBLESHOOTING

This section offers solutions to potential problems you may experience with your P520 printer. The table below lists the screen messages that will be displayed on the printer's LCD, both during normal operation and to alert operator of any error conditions. There is also some additional information dealing with quality issues concerning printing onto cards.

5 • 1 *Interpreting LCD Display messages*

A • About the Printing Station

SCREEN MESSAGE	MEANING	ACTION
INITIALIZING	The printer is performing an internal test before use	Wait for the ready message
READY	Ready for use	
WAIT TEMPERATURE	Print Head cool down mode	
SELF TEST	Self test card printing	Wait for card printing to start
DOWNLOADING DATA	The card data is being transmitted	
PRINTING YELLOW	The yellow panel is being printed	
PRINTING MAGENTA	The magenta panel is being printed	
PRINTING CYAN	The cyan panel is being printed	

SCREEN MESSAGE	MEANING	ACTION
PRINTING BLACK	A monochrome panel is being printed	
PRINTING VARNISH	The overlay is printing	
PRINT HOLOGRAM	A hologram overlay is printing	
CLEAN PRINTER	The printer is prompting operator maintenance	Carry out the cleaning procedure as detailed in section 4 of this manual
CLEAN MAG HEAD	The printer is prompting operator	Carry out the cleaning procedure as detailed in Appendix A of this manual
CLEANING	The printer is performing an internal cleaning routine	
REMOVE RIBBON	The ribbon has not been removed while the cleaning operation is in progress	Remove ribbon
OUT OF RIBBON	The printer ribbon has run out	Replace printer ribbon
MECHANICAL ERROR	The printer has an error moving the card internally	Remove the jamed card. Ensure the card is not out of specification
OUT OF CARD	The card feeder is empty	Add more cards or adjust the card feeder to accept the cards
ROTATION ERROR	The printer has an error moving the card in the flip	Remove card
COVER OPEN	The cover is open	Close the cover
HEAD OPEN	The print head is not locked into position	Lock the print head in its lower position
COMMAND ERROR	The data being sent from the host is not recognised	Check that the data is suitable for printing. Try reprinting a card from known "good" data
PARAMETERS ERROR	The features of the card are not recognised	Check the windows driver options and printer type
ENCODING ERROR	Data cannot be written or read from the card's magnetic stripe Data cannot be read from the card's magnetic stripe The reject box is full The printer cannot detect a magnetic stripe on the card	Check that the cards are loaded with the magnetic stripe in the correct orientation. Check whether high or low coercivity cards have been specified. Check that the data conforms to ISO specifications. See Appendix A of this manual for further information.

SCREEN MESSAGE	MEANING	ACTION
READING ERROR	Data cannot be read from the card's magnetic stripe	Check that the cards are loaded with the magnetic stripe in the correct orientation. Check whether high or low coercivity cards have been specified. Check that the data conforms to ISO specifications. See Appendix A of this manual for further information.
REJECT BOX FULL	The reject box is full	Empty the reject card box and press the right panel button
MAGNETIC ERROR	The printer cannot detect a magnetic stripe on the card	Check the card orientation
FLASH ERROR		Contact your dealer for technical support
NO ACCESS		

Ribbon Errors: Check that the print ribbon has not “run out”. Lock and then unlock the print head assembly; this resynchronises the ribbon automatically. When using a color ribbon, it should advance automatically so that the leading edge of the yellow panel is beneath the print head. Ensure that the correct ribbon type has been specified in the Windows driver.

Card Feed & Mechanical Errors: Ensure that the card thickness adjustment has been set-up correctly to allow one card to feed.

Magnetic Encoding Errors: Check that the cards are inserted correctly in the printer. Ensure that the cards are low or high coercivity as required, and are set-up correctly in the printer driver.

Cleaning Alert: The printer has counted the number of cards printed and has automatically flagged that a cleaning routine needs to be carried out. (See Chapter 4).

B • About the Laminator Station

SCREEN MESSAGE	MEANING	ACTION
INITIALISING	The printer is performing an internal test before use	Wait for the ready message
READY	Ready for use	
COVER OPEN	The cover is open	Close cover
ROTATION ERROR	The printer has an error moving the card in the flip	Remove card
LAMINATING	The printer is processing a lamination	Wait for the laminated card
OUT OF RIBBON	The printer ribbon has run out	Load a new ribbon
MECHANICAL ERR	the printer has an error moving the card internally	Remove the jamed card. Ensure the card is not out of specification.
TEMPERATURE ERR	The printer has detected a temperature error	Proceed an initialization by switching Off and On.
WARMING UP	A lamination command has been sent and the temperature has not reached +/- 7°C of the recommended temp.	Wait until the printer has reached the recommended temperature
RIBBON FAILURE	The film is glued to the card during the cool down period.	Open laminator bracket. Remove card. Close laminator bracket.
STANDBY MODE	Laminator power reduced.	

5 • 2 Print Quality Issues

This section will help you resolve print quality problems. The print quality is dependent on several factors. The two most important factors that will increase your print quality are cleanliness and card stock. To diagnose and fix print quality problems, follow the troubleshooting procedure below:

- Small spots appear on the printed card with a non-printed area or a different color.

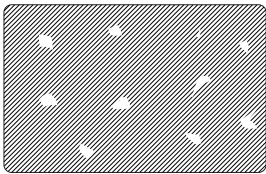

Possible Cause

- A • Contamination on the card surface.
- B • Dust inside the printer and/or dirty Cleaning Roller.

>> Solution

- A1 • Check that cards are stored in a dust free environment
- A2 • Use a different supply of cards.
- B1 • Perform a Cleaning of the printer (see Cleaning section).
- B2 • Replace Cleaning Roller (see Cleaning section)

- There are non-printing horizontal lines (white) on the card surfaces.



Possible Cause

- A • Ribbon is not correctly positioned.
- B • Print Head may be dirty.
- C • Print Head elements may have been damaged (e.g. scratched or burnt).

>> Solution

- A1 • Open cover and press down the Print Head Unlock Lever to open the Print Head carriage. The Print Head will move up.
- A2 • Check that the ribbon is properly rolled onto the ribbon cores and there are no wrinkles in the ribbon.
- A3 • Push down on the Lock Lever until an audible "click" signals the locked-down position.
- A4 • Ribbon will automatically synchronize.
- A5 • Print again.
- B1 • Perform a Cleaning of the Print Head (see 4 • 2 Cleaning the Print Head).
- C1 • Call service for Print Head replacement information.

• Printing shows very pale or inconsistent results.

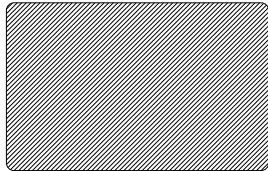

Possible Cause

- A • Ribbon have been stored improperly or is damaged.
- B • Cards may not meet specifications.
- C • Contrast and/or Intensity may be set to values which are too high.
- D • Dust or embedded contamination on elements of the Print Head.

>> **Solution**

- A1 • Change ribbon and print again.
- B1 • Use a different supply of cards.
- C1 • Adjust Contrast and/or Intensity values in software.
- D1 • Perform a Cleaning of the Print Head (see 4 • 2 Cleaning the Print Head).

• Printing shows blurry printed image.

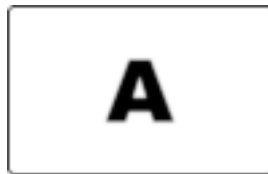

Possible Cause

- A • Ribbon may not be correctly positioned.
- B • Ribbon may not synchronized on the correct color panel position.
- C • Cards may not meet specifications.
- D • Dust inside the printer and/or dirty Cleaning Roller.

>> **Solution**

- A1 • Open cover and press down the Print Head Unlock Lever to open the Print Head carriage. The Print Head will move up.
- A2 • Check that the ribbon is properly rolled onto the ribbon cores.
- A3 • Push down on the Print Head Lock Lever until an audible “click” signals the locked-down position.
- A4 • Ribbon will automatically synchronize.
- A5 • Print again.
- B1 • Open cover and press down the Print Head Unlock Lever to open the Print Head carriage. The Print Head will move up.
- B2 • Push down on the Print Head Lock Lever until an audible “click” signals the locked-down position.
- B3 • Ribbon will automatically synchronize.
- B4 • Print again.
- C1 • Use a different supply of cards.
- D1 • Perform a cleaning of the Print Head (See 4 • 2 Cleaning the Print Head).
- D2 • Replace Cleaning Roller (See 4 • 3 Cleaning Cartridge).

- No printing on the card.



Possible Cause

- A • Ribbon may not be installed in the printer.
- B • Cards may not meet specifications.
- C • Cable on Print Head may be disconnected.
- D • Print Head elements may be scratched or burnt.

>> **Solution**

- A1 • Check for ribbon in the printer.
- B1 • Use a different supply of cards.
- C1 • Power off the printer and check the Print Head cable connections.
- D1 • Call Service for Print Head replacement information.



For optimum print quality, always keep cover of the printer closed except during ribbon loading and card thickness control procedures.

The card flipper will not operate and an error will be indicated if you try to flip a card with the cover open.

TECHNICAL SPECIFICATIONS



General

- High speed printing & laminating
YMCK & 1.0 mil lamination 110 cards per hour
YMCK & 0.6 mil lamination 120 cards per hour
YMCK-K & 1.0 mil lamination 95 cards per hour
YMCK-K & 0.6 mil lamination 105 cards per hour
- Small footprint
- Windows Drivers for 95/98/2000 and NT 4.0
- One year printer warranty
- One year print head warranty

Color Printing

- Color dye sublimation or monochrome thermal transfer printing
- 300 dpi (11.8 dots/mm) print resolution
- Edge to edge printing standard

Bar Code

- Code 39
- Code 128 B & C with & without check digit
- 2 of 5 & 2 of 5 industrial
- UPCA
- EAN8 & EAN13
- PDF 417 2D bar code and other symbologies available via Wincard Classic utility tool (option)

Fonts

- Resident: Arial Normal 100, Arial Bold 100
- TrueType fonts available via Windows Driver

Cards

- Types PVC, Composite
- Card width/length: ISO CR-80 - ISO 7810, 2.125" (54mm) by 3.375" (86mm)
- Option: Magnetic Stripe - ISO 7811
- Option: Smart Card - ISO 7816-2
- Card thickness: 10mil (0,25mm) to 50mil (1,25mm) for printing only and 0,8mm for printing and lamination.
- Card Feeder capacity: up to 300 cards (10mil), up to 100 cards (30mil)
- Card Output Hopper capacity: 300 cards (10mil), up to 100 cards (30mil)

CARD DIMENSIONS

ISO STANDARD DIMENSIONS FOR PLAIN CARD

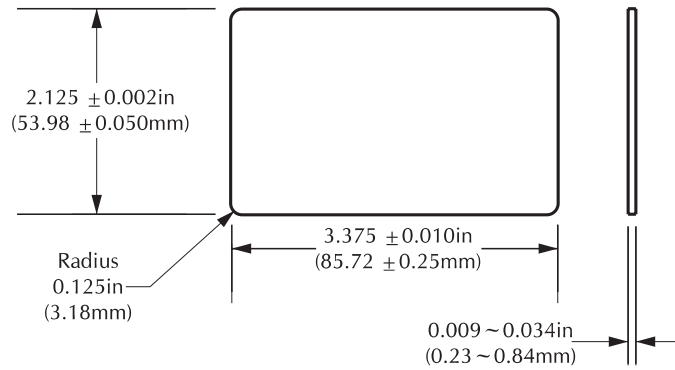

ISO STANDARD DIMENSIONS FOR MAGNETIC STRIPE CARD

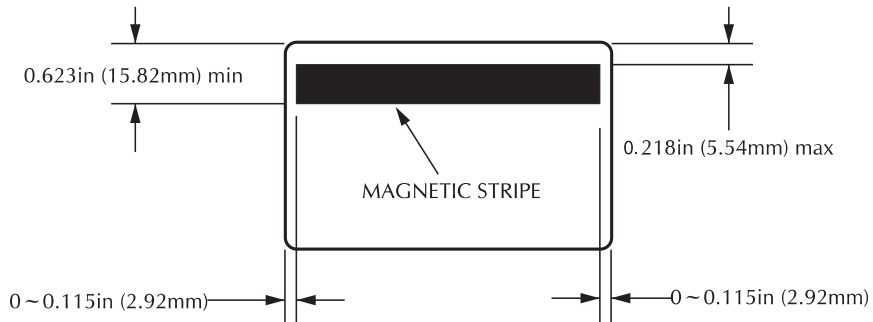

CHIP POSITION FOR SMART CARD

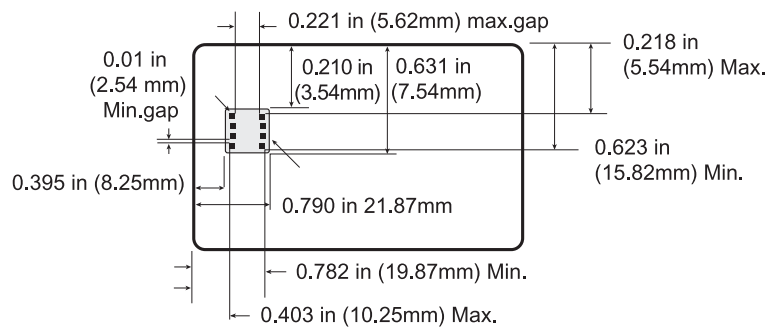

Ribbons	<ul style="list-style-type: none"> • Monochrome: 1500 cards/roll • Monochrome colors: back, red, blue, green, yellow, silver, gold, white. • K-resin + O: 800 cards/roll • K-dye + O: 800 cards/roll • YMC: 300 cards/roll • YMCK: 250 cards/roll • YMCK-K: 200 cards/roll • YMCKO: 350 cards/roll • YMCKOK: 250 cards/roll
Patches	<ul style="list-style-type: none"> • Clear Patch 1 or 0.6 mil • Clear Patch for mag. stripe 1 or 0.6 mil • Clear Patch for smart card 1 or 0.6 mil • Hologram Pcard Patch 1 or 0.6 mil • Advantage seal Pcard image Patch 1 mil • Hologram Pcard full overlay • Varnish full overlay
Overlay Varnish	<ul style="list-style-type: none"> • Thermal transfer • 4 microns thick • Clear and holographic options: <ul style="list-style-type: none"> - Clear - Genuine/Secure Hologram - Custom Hologram
Interfaces	<ul style="list-style-type: none"> • Centronics Parallel Standard • USB port (Optional)
Mechanical	<ul style="list-style-type: none"> • Width: 31,69" (805mm*) • Depth: 9,25" (235mm*) • Height: 10,43" (265mm*) • Weight: 47,28 lbs (21,45 kg)
Electrical	<ul style="list-style-type: none"> • 110 ~ 230 Volts AC, 60 ~ 50 Hz • FCC Class A, CE, UL, and CUL approved
Environmental	<ul style="list-style-type: none"> • Operating Temperature: 60 to 86°F (15 to 30°C) • Operating Humidity: 20 to 65% non condensing • Storage Temperature: -23 to 158°F (-5 to 70°C) • Storage Humidity: 20 to 70% non condensing • Ventilation: Free air

Dye sublimation printing requires dye sublimation ribbons, with either black or cyan, magenta, and yellow (plus black resin) panels.

*Measured without card output hopper.

Options	<ul style="list-style-type: none"> • USB port • Smart card Contact Station (0.76mm cards only) • Magnetic Encoder (0.76mm cards only) • Cleaning supplies
----------------	---

CENTRONIC CABLE INTERFACE

The above drawing shows the required connections to use the printer centronic interface.

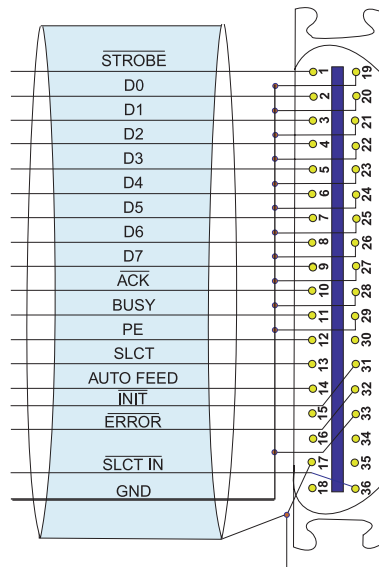

Printer Pin	Lign Name
1	-STROBE
2	D0
3	D1
4	D2
5	D3
6	D4
7	D5
8	D6
9	D7
10	-ACK
11	-BUSY
12	PE
13	SLCT
14	-AUTO FEED
32	-ERROR
31	-INIT
36	SLCT IN
19-30-33	GND

Note: The printer pins number 15, 16, 18, 30, 34, 35 are not connected.

A

APPENDIX

Magnetic Card Stripe Encoder

This section contains information on the additional operations of the P520 Printers with Magnetic Card Stripe Encoder.
(See Chapter 2 for location.)

INTRODUCTION

Operation and maintenance requirements for the P520 Printer with the optional magnetic card stripe encoder.
(See Chapter 2 for location.)
The magnetic encoder can be set for either high or low coercivity.

A • MEDIA LOADING ORIENTATION

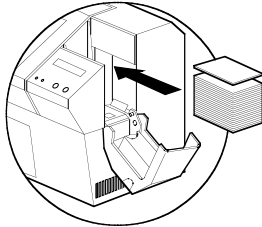

The magnetic encoder is a factory installed item with the read/write head positioned below the card path, available with HICO encoding or LOCO encoding.

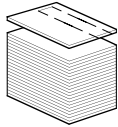

When loading cards into the Card Cartridge, please ensure that the magnetic stripe is facing down and closest to the rear.

Also available are Printer models with the Magnetic Read/Write head positioned above the card path, with HICO encoding or LOCO encoding.

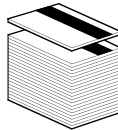

When loading cards, please ensure that the magnetic stripe is facing up and closest to the rear.

Note:

M1 = Stripe Down HICO M3 = Stripe up HICO

M2 = Stripe Down LOCO M4 = Stripe up LOCO

approved HICO & LOCO PVC cards are available. (See Appendix C).



ONLY USE cards that comply with ISO 7810 & 7811 standards for magnetic stripe cards. The magnetic stripe must be flush to the surface of the card to work properly. Never use cards which have taped-on magnetic stripes.

B • MAGNETIC ENCODER CLEANING

There exists two different processes to clean the Magnetic stripe Encoder. The first process consists of a standard cleaning of the printer. This cleans the most important parts of the printer; including the print Head, Transport Roller and Magnetic Stripe Encoder (refer to chapter 4 "Cleaning" for more instructions.)

The second process consist of a cleaning of the Magnetic Encoder using the Menu Button from the LCD Display.

To access the Magnetic Cleaning Menu proceed as below:

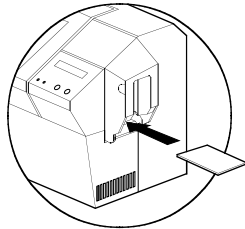

- 1 • Leave power on.
- 2 • Remove cards from the card feeder.
- 3 • Insert one presaturated card (provided) through slot on the side of the Card Cartridge.
- 4 • Press the Menu button until the LCD screen shows CLEANING MENU.
- 5 • Press the Select button to select.
- 6 • Press the Menu button again until the LCD screen shows CLEAN MAG HEAD.
- 7 • Run this operation by pressing the select button.

ISO STANDARD ENCODING

Track #	Field Separator	Track density	Valid Characters	# of characters
1	^	210BPI*	Alphanumeric (ASCII 20 - 95**)	79***
2	=	75BPI*	Numeric (ASCII 48 - 62)	40***
3	=	210BPI*	Numeric (ASCII 48 - 62)	107***

* Bit per inch

** Except the "?" character

*** Including Start, Stop and LRC characters. Also note that these 3 characters are automatically managed by the magnetic encoder according to the ISO Standard norms.

NOTE: Refer to the Card Printer Programmer's Manual for complete programming information.

B APPENDIX

Smart Card Contact Station

This section contains information on the additional operations of the P520 Printers with Smart Card Contact Stations.
(See Chapter 2 for location.)

INTRODUCTION

Your P520 may be equipped with an optional Smart Card contact station. Smart Cards can store fingerprints, voice recognition patterns, medical records and other such data.

This printer model basically responds to commands that position the cards to the contact station, where the printer connects the pins to the contacts connector on the Smart cards.

An external "encoder/reader" is necessary for programming Smart Cards (ISO 7816). All other printer operations remain the same as the standard P520 model.

A • MEDIA LOADING ORIENTATION

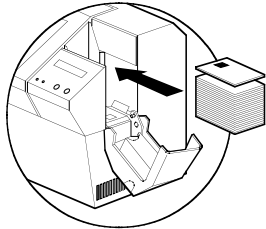

Position the cards with the Smart Card Chip at the top of the card and towards the printer.

B • SMART CARD CONTACT STATION INTERFACE

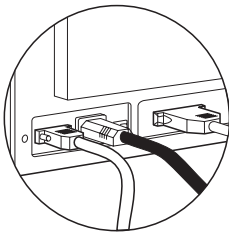

When a command to the parallel printer interface sends a card to the Smart Card Contact Station, the printer connects the Smart Card Contact Station to the female DB-9 connector on the rear of the printer. An attached external Smart Card Programmer can be used to program Smart card chips

DB - 9 PINS	SMART CARD CONTACT POINTS	DB - 9 PINS	SMART CARD CONTACT POINTS
1	C1 (VCC)	6	C6 (Vpp)
2	C2 (Reset)	7	C7 (I/O)
3	C3 (Clock)	8	C8 (RFU)
4	C4 (RFU)	9	(GND when chip is at station)
5	C5 (GND)		

Refer to the Card printer programmer's Manual for complete programming information.



DO NOT position printing over the Smart Card Chip.

APPENDIX C

Accessories & Supplies

Please contact your Eltron authorised dealer to place an order for accessories and supplies.



Use only Zebra-approved card, ribbon and patches media. Using non-approved card or ribbon media can void your warranty.

Refer to the Accessories section for more information about Card and Ribbon Media available from Zebra Technologies Corp.

RIBBONS FOR PRINTING ONLY:

Part Number	Description	Cards/roll
800015-101 to 109	Monochrome Ribbon	1000
800015-120 to 122	Hologram or varnish	350
800015-140	YMCKO	200
800015-148	YMCKOK	170
800015-150	Kdye-0	500
800015-160	KO	600
800015-301 to 309	Monochrome Ribbon	1500
800015-340	YMCKO	350
800015-348	YMCKOK	250
800015-350	Kdye-0	800
800015-360	Ko	800

RIBBONS FOR PRINTING AND LAMINATION:

PRINTING STATION		compatibility LAMINATOR STATION		
Part Number	Description	Patch 1 mil -012 to -017	Patch 0.6 mil -135 to -138	Full Overlay -125 & -131
800015-101 to 109	Monochrome Ribbon	no	yes	yes †
800015-140	YMCKO	no*	no*	yes
800015-145	YMCK	yes	yes	no
800015-148	YMCKOK	no*	no*	yes
800015-150	Kdye-0	no*	no*	yes
800015-160	KO	no*	no*	yes
800015-170	YMC	yes	yes	no
800015-180	YMCKK	yes	yes	no
800015-301 to 309	Monochrome Ribbon	no	yes	yes †
800015-340	YMCKO	no*	no*	yes
800015-345	YMCK	yes	yes	no
800015-348	YMCKOK	no	no	yes
800015-350	Kdye-0	no*	no*	yes
800015-360	KO	no*	no*	yes

NOTE: * These ribbons can possibly be used without using the "O"-Panel.

† These ribbons can only be used with the full overlay Part Number 800015-125 and not with the 800015-131.



Only 30 mil cards should be used when the card is to be laminated.
Use 30 mil composite cards whenever possible to ensure compliance of the finished card to ISO flatness guidelines.

CARDS FOR PRINTING AND LAMINATION:

Part Number	Description	Card/pack	thickness
104523-111	premier grade PVC	100	30mil
104523-112	premier grade PVC LoCo	100	30mil
104523-113	premier grade PVC HiCo	100	30mil
104524-101	premier plus grade composite	100	30mil
104524-102	premier plus grade composite LoCo	100	30mil
104524-103	premier plus grade composite HiCo	100	30mil

CARDS FOR PRINTING ONLY:

Part Number	Description	Card/pack	thickness
104523-114	premier grade PVC	100	10mil
104523-110	premier grade PVC adhesive back	100	10mil
104523-111	premier grade PVC	100	30mil
104523-112	premier grade PVC LoCo	100	30mil
104523-113	premier grade PVC HiCo	100	30mil
104524-101	premier plus grade composite	100	30mil
104524-102	premier plus grade composite LoCo	100	30mil
104524-103	premier plus grade composite HiCo	100	30mil

PATCHES FOR LAMINATION:

Part Number	Description	Cards/roll
	Patch 1 mil	
800015-012	clear patch 1 mil with coverage for mag. stripe	100
800015-013	clear patch 1 mil with coverage for smart card	100
800015-014	clear patch 1 mil	100
800015-015	hologram Pcard patch 1 mil	100
800015-017	advantage Seal Pcard Image patch 1 mil	90
	Full overlay ribbon	
800015-125	hologram Pcard full overlay	350
800015-131	varnish full overlay	350
	patch 0.6 mil	
800015-135	clear patch 0.6 mil	175
800015-136	clear patch 0.6 mil with coverage for smart card	175
800015-137	clear patch 0.6 mil with coverage for mag. stripe	175
800015-138	hologram Pcard patch 0.6 mil	170

ACCESSORIES

Accessories available for P520 printers appear below. Always refer to the part number when placing an order.

Printer supplies	
Part Number	Description
300320-001 206851-001 105909-112	Centronics Parallel cable (36 pins) Additional Card Output Hopper Replacement Print Head Kit

Cleaning Supplies	
Part Number	Description
105909-169 105912-003 105912-002 105909-055 105909-057	Premier Cleaning Kit (25 swabs, 50 cards) Adhesive Cleaning Roller Kit (set of 5) Cleaning Cartridge, complete Cleaning Card Kit (box of 100 cards) Cleaning Swab Kit (box of 25 swabs)

Documentation	
Part Number	Description
980312-001 980312-002 980312-051 980312-061 980312-071 980312-081 980081-001 980264-001	P520 User's Manual (English & Spanish) P520 User's Manual (French & German) P520 User's Manual (Italian) P520 User's Manual (Chinese) P520 User's Manual (Japanese) P520 User's Manual (Portuguese) Pseies Programmer's Manual (English only) P520 Maintenance Manual (English only)

Miscellaneous	
Part Number	Description
105536-001 806503-001 104527-001	CD ROM (Software, Windows Drivers, Documentation) Card Punch (slots card for lapel clip) Lapel Clips (pack of 100 clips)

World Wide Sales and Support:

Zebra Technologies Corporation
Eltron Card Printer Products
1001 Flynn Road
Camarillo, CA 93021-8706.USA
Phone: + 1(805) 579 1800
Fax.: + 1 (805) 579 1808
Toll Free in US: (800) 452-4056
e-mail: cards@eltron.com

Zebra Technologies Corporation
Eltron card Printer Products, (Europe, Middle East, Africa)
The Valley Centre, Gordon Road, High Wycombe
Buckinghamshire HP13 6EQ, England
Phone: + 44 (0) 870 241 1527
Fax.: + 44 (0) 870 241 0765
e-mail: eurosales@eltron.com

Zebra Technologies France
Eltron card Printer Products, France
50, 56 rue Marcel Dassault
92100 Boulogne-Billancourt, France
Phone: + 33 1 55 20 93 93
Fax.: + 33 1 55 20 93 99
e-mail: frsales@eltron.com

Zebra Technologies Corporation
Eltron card Printer Products, Latin America
6175 NW 153 rd Street, Suite # 121
Miami Lakes, FL 33014 USA
Phone: + 1 (305) 558 8470
Fax: + 1 (305) 558-8485
e-mail: latinsales@eltron.com

Zebra Technologies Corporation
Eltron Card Printer Products, Asia/Pacific
1 Sims lane # 06-11
387355 Singapore
Phone: + 65 84 20 322
Fax.: + 65 84 20 514
e-mail: asiasales@eltron.com

CORPORATE HEADQUARTERS
Zebra Technologies Corporation
333 Corporate Woods Parkway
Vernon Hills, IL 60061-3109 USA
Phone: 1 (847) 634 6700
Fax.: + 1 (847) 913 8766
e-mail: sales@Zebra.com



Zebra Technologies Corporation



P/N:980312-001A