

TOP-MOUNT REFRIGERATOR

Use & Care Guide

Table of Contents 2

TABLE OF CONTENTS

REFRIGERATOR SAFETY	3
INSTALLING YOUR REFRIGERATOR	4
Unpacking Your Refrigerator	4
Space Requirements.....	4
Electrical Requirements	5
Connecting the Refrigerator to a Water Source	5
Base Grille	6
Refrigerator Doors: Removing, Reversing and Replacing.....	7
Door Closing and Alignment	8
Understanding Sounds You May Hear	9
USING YOUR REFRIGERATOR	9
Ensuring Proper Air Circulation.....	9
Setting the Control(s)	10
Adjusting Control Settings	10
REFRIGERATOR FEATURES	11
Refrigerator Shelves	11
Lateral Adjustable Shelf	11
Meat Drawer and Cover	12
Chilled Meat Drawer.....	12
Crisper and Crisper Cover	12
Crisper Humidity Control	13
Utility or Egg Bin.....	13
Wine or Can/Bottle Rack	13
FREEZER FEATURES	14
Ice Maker.....	14
Freezer Shelf	14
Adjustable Half-width	
Freezer Shelf	15
Pull-out Freezer Floor.....	15
DOOR FEATURES	15
Door Rails	15
Door Bins.....	15
Can Rack.....	15
Adjustable Utility Compartment & Tray	15
Flip-up Door Shelf	16
CARING FOR YOUR REFRIGERATOR	16
Cleaning Your Refrigerator.....	16
Changing the Light Bulbs.....	16
Power Interruptions.....	17
Vacation and Moving Care.....	17
TROUBLESHOOTING	17
ASSISTANCE OR SERVICE	19
WARRANTY	20

REFRIGERATOR SAFETY

Your safety and the safety of others are very important.

We have provided many important safety messages in this manual and on your appliance. Always read and obey all safety messages.



This is the safety alert symbol.

This symbol alerts you to potential hazards that can kill or hurt you and others.

All safety messages will follow the safety alert symbol and either the word "DANGER" or "WARNING." These words mean:

! DANGER

You can be killed or seriously injured if you don't immediately follow instructions.

! WARNING

You can be killed or seriously injured if you don't follow instructions.

All safety messages will tell you what the potential hazard is, tell you how to reduce the chance of injury, and tell you what can happen if the instructions are not followed.

IMPORTANT SAFETY INSTRUCTIONS

WARNING: To reduce the risk of fire, electric shock, or injury when using your refrigerator, follow these basic precautions:

- Plug into a grounded 3 prong outlet.
- Do not remove ground prong.
- Do not use an adapter.
- Do not use an extension cord.
- Disconnect power before servicing.
- Replace all panels before operating.
- Remove doors from your old refrigerator.
- Use nonflammable cleaner.
- Keep flammable materials and vapors, such as gasoline, away from refrigerator.
- Use two or more people to move and install refrigerator.
- Disconnect power before installing ice maker (on ice maker kit ready models only).
- Use a sturdy glass when dispensing ice or water (on some models).

SAVE THESE INSTRUCTIONS

Proper Disposal of Your Old Refrigerator

! WARNING

Suffocation Hazard

Remove doors from your old refrigerator.

Failure to do so can result in death or brain damage.

IMPORTANT: Child entrapment and suffocation are not problems of the past. Junked or abandoned refrigerators are still dangerous – even if they will sit for "just a few days." If you are getting rid of your old refrigerator, please follow these instructions to help prevent accidents.

Before you throw away your old refrigerator or freezer:

- Take off the doors.
- Leave the shelves in place so that children may not easily climb inside.

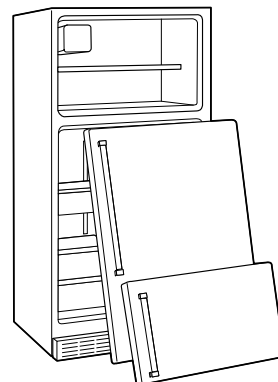

INSTALLING YOUR REFRIGERATOR

Unpacking Your Refrigerator

⚠ WARNING

Excessive Weight Hazard

Use two or more people to move and install refrigerator.

Failure to do so can result in back or other injury.

Remove shelves from the shipping position (shelves are shipped upside down):

IMPORTANT: Do not clean glass shelves with warm water when they are cold. Shelves may break if exposed to sudden temperature changes or impact, such as bumping. For your protection, tempered glass is designed to shatter into many small pebble-size pieces. This is normal.

NOTE: Glass shelves are heavy. Use special care when removing them to avoid impact from dropping.

1. Grasp the front of the upper shelf with one hand and use the other hand to remove packing material from the shelf area.
2. Lower the front of the upper shelf until shelf hooks can be removed from the shelf supports and pull the shelf forward.
3. Flip the shelf over and insert the rear shelf hooks into the shelf supports. Tilt the front of shelf up until rear shelf hooks drop into the shelf supports.
4. Lower the front of the shelf and check to make sure that it is securely in position.

Removing packaging materials

- Remove tape and any labels from your refrigerator before using (except the model and serial number label).
To remove any remaining tape or glue, rub the area briskly with your thumb. Tape or glue residue can also be easily removed by rubbing a small amount of liquid dish soap over the adhesive with your fingers. Wipe with warm water and dry.
- Do not use sharp instruments, rubbing alcohol, flammable fluids, or abrasive cleaners to remove tape or glue. These products can damage the surface of your refrigerator. For more information, see "Refrigerator Safety" section.
- On some models, shelves, bins, door shelf rails, and other feature parts may be packaged in the Interior FeaturePak. Follow the instructions contained in the package for proper assembly.

IMPORTANT:

- Depending on your model, do not remove any permanent instruction labels inside your refrigerator or the Tech Sheet that is fastened behind the base grille.

- Depending on your model, do not remove the white Styrofoam insert that is located behind the control panel on the ceiling of the refrigerator. The insert is part of the refrigerator and not part of the packing material. If the insert is removed, ice may migrate down from the freezer and cause icicles to form.

When Moving Your Refrigerator:

Your refrigerator is heavy. When moving the refrigerator for cleaning or service, be sure to protect the floor. Always pull the refrigerator straight out when moving it. Do not wiggle or "walk" the refrigerator when trying to move it, as floor damage could occur.

Space Requirements

⚠ WARNING



Explosion Hazard

Keep flammable materials and vapors, such as gasoline, away from refrigerator.

Failure to do so can result in death, explosion, or fire.

- To ensure proper ventilation for your refrigerator, allow for a .5 in. (1.25 cm) space on each side and at the top.

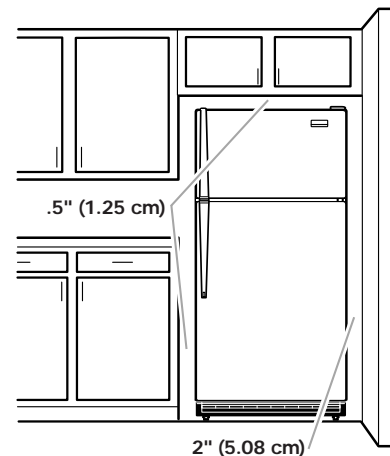

- If your refrigerator has an ice maker, make sure you leave some extra space at the back for the water line connections. The refrigerator can be flush against the back wall if you do not have an ice maker installed.
- If you are installing your refrigerator next to a fixed wall, leave 2 in. (5.08 cm) minimum on each side (depending on your model) to allow for the door to swing open.

NOTE: Do not install the refrigerator near an oven, radiator, or other heat source, nor in a location where the temperature will fall below 55°F (13°C).

Electrical Requirements

⚠ WARNING



Electrical Shock Hazard

Plug into a grounded 3 prong outlet.

Do not remove ground prong.

Do not use an adapter.

Do not use an extension cord.

Failure to follow these instructions can result in death, fire, or electrical shock.

Before you move your refrigerator into its final location, it is important to make sure you have the proper electrical connection:

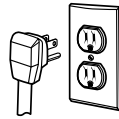

Recommended grounding method

A 115 Volt, 60 Hz., AC only 15 or 20 ampere fused, grounded electrical supply is required. It is recommended that a separate circuit serving only your refrigerator be provided. Use an outlet that cannot be turned off by a switch. Do not use an extension cord.

NOTE: Before performing any type of installation, cleaning, or removing a light bulb, turn the control, (Thermostat, Refrigerator or Freezer Control depending on the model) to OFF and then disconnect the refrigerator from the electrical source. When you are finished, reconnect the refrigerator to the electrical source and reset the control (Thermostat, Refrigerator or Freezer Control depending on the model) to the desired setting.

Connecting the Refrigerator to a Water Source

Read all directions carefully before you begin.

IMPORTANT:

- If operating the refrigerator before installing the water connection, turn ice maker to the OFF position to prevent operation without water.
- All installations must be in accordance with local plumbing code requirements.
- Use copper tubing and check for leaks.
- Install copper tubing only in areas where temperatures will remain above freezing.
- It may take up to 24 hours for your ice maker to begin producing ice.

Tools required:

- Standard screwdriver
- $\frac{7}{16}$ in. and $\frac{1}{2}$ in. open-end wrenches or two adjustable wrenches
- $\frac{1}{4}$ in. nut driver
- $\frac{1}{4}$ in. drill bit
- Hand drill or electric drill (properly grounded)

NOTE: Your refrigerator dealer has a kit available with a $\frac{1}{4}$ in. (6.35 mm) saddle-type shut-off valve, a union, and copper tubing. Before purchasing, make sure a saddle-type valve complies with your local plumbing codes. Do not use a piercing-type or $\frac{3}{16}$ in. (4.76 mm) saddle valve which reduces water flow and clogs more easily.

Cold water supply

The ice maker water valve contains a flow washer which is used as a water pressure regulator. The ice maker needs to be connected to a cold water line with water pressure between 30 and 120 psi. If a problem occurs, call your utility company.

Connecting to water line:

1. Unplug refrigerator or disconnect power.
2. Turn OFF main water supply. Turn ON nearest faucet long enough to clear line of water.
3. Locate a $\frac{1}{2}$ in. to $1\frac{1}{4}$ in. (12.7 mm to 3.18 cm) vertical COLD water pipe near the refrigerator.

NOTE: Horizontal pipe will work, but the following procedure must be followed: Drill on the top side of the pipe, not the bottom. This will help keep water away from the drill. This also keeps normal sediment from collecting in the valve.

4. To determine the length of copper tubing you will need, measure from connection on lower left rear of refrigerator to water pipe. Add 7 ft. (2.1 m) to allow for moving refrigerator for cleaning. Use $\frac{1}{4}$ in. (6.35 mm) O.D. (outside diameter) copper tubing. Be sure both ends of copper tubing are cut square.
5. Using a grounded drill, drill a $\frac{1}{4}$ in. hole in the cold water pipe you have selected.

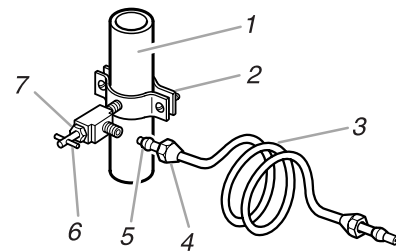

1. Cold Water Pipe
2. Pipe Clamp
3. Copper Tubing
4. Compression Nut
5. Compression Sleeve
6. Shut-Off Valve
7. Packing Nut

6. Fasten shut-off valve to cold water pipe with pipe clamp. Be sure outlet end is solidly in the $\frac{1}{4}$ in. drilled hole in the water pipe and that washer is under the pipe clamp. Tighten packing nut. Tighten the pipe clamp screws carefully and evenly so washer makes a watertight seal. Do not overtighten or you may crush the copper tubing, especially if soft (coiled) copper tubing is used. Now you are ready to connect the copper tubing.

7. Slip compression sleeve and compression nut on copper tubing as shown. Insert end of tubing into outlet end squarely as far as it will go. Screw compression nut onto outlet end with adjustable wrench. Do not overtighten.
8. Place the free end of the tubing into a container or sink, and turn ON main water supply and flush out tubing until water is clear. Turn OFF shut-off valve on the water pipe. Coil copper tubing.

Connecting to refrigerator:

1. Attach the copper tube to the valve inlet using a compression nut and sleeve as shown. Tighten the compression nut. Do not overtighten. Use the tube clamp on the back of the refrigerator to secure the tubing to the refrigerator as shown. This will help prevent damage to the tubing when the refrigerator is pushed back against the wall. Move to step 2.
2. **Turn shut-off valve ON. Check for leaks.** Tighten any connections (including connections at the valve) or nuts that leak.

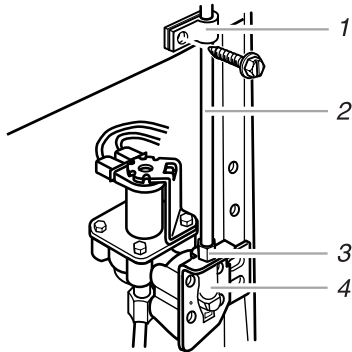

1. Tube Clamp
2. Copper Tubing
3. Compression Nut
4. Valve Inlet

3. The ice maker is equipped with a built-in water strainer. If local water conditions require periodic cleaning or a well is your source of water supply, a second water strainer should be installed in the ¼ in. (6.35 mm) water line. Obtain a water strainer from your nearest appliance dealer. Install at either tube connection.
4. Plug in refrigerator or reconnect power.

Base Grille

To remove the base grille:

1. Open the refrigerator door.
2. Grasp the grille with both hands.
3. Lift up and tilt the bottom of the grille toward you.

NOTE: Do not remove the Tech Sheet that is fastened behind the grille.

To replace the base grille:

1. Open the refrigerator door.
2. Place upper clips in openings in the metal panel.
3. Roll the grille down toward the refrigerator until it snaps into place.

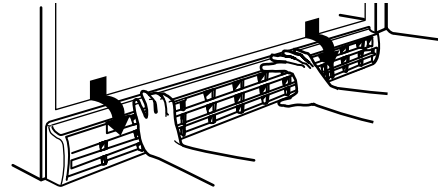

Refrigerator Doors: Removing, Reversing (optional) and Replacing

TOOLS NEEDED: 5/16 in. hex-head socket wrench, No. 2 Phillips screwdriver, flat-head screwdriver, 5/16 in. open-end wrench, flat 2 in. putty knife.

IMPORTANT: Before you begin, turn the refrigerator control OFF, unplug refrigerator or disconnect power. Remove food and any adjustable door or utility bins from doors.

Door Removal & Replacement

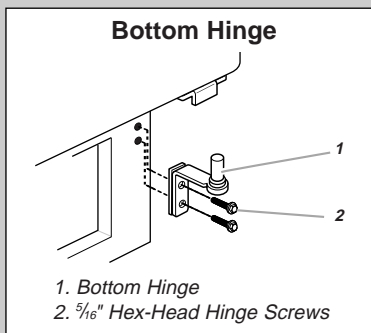
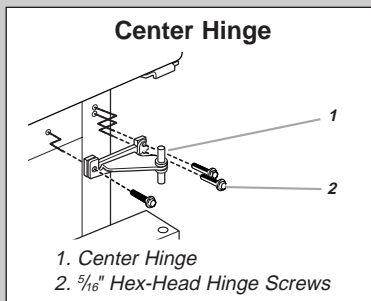
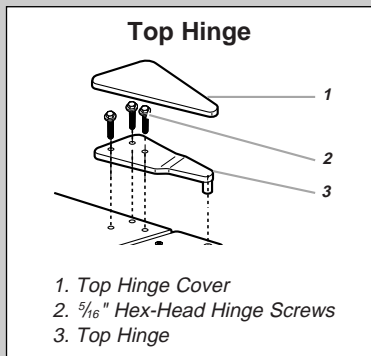
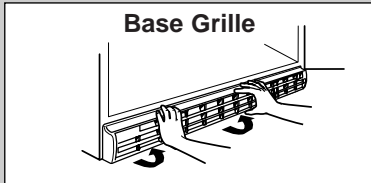

Door Swing Reversal (optional)

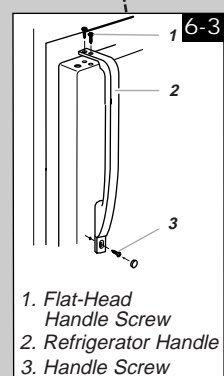
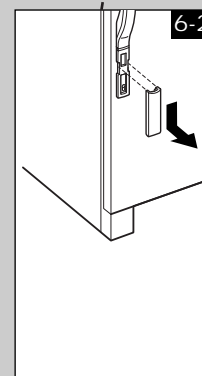
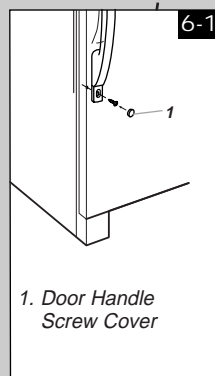
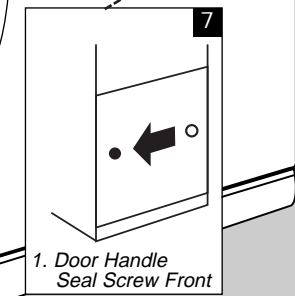
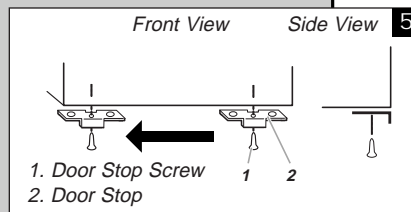
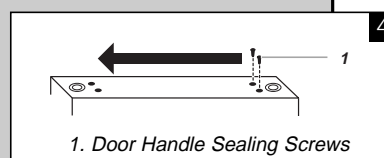
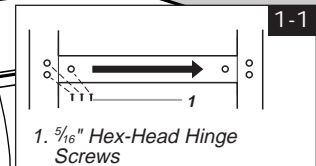
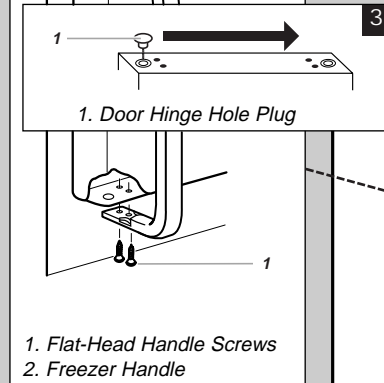
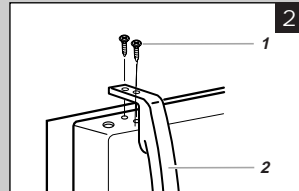

Door and hinge removal

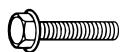

5/16" Hex Head Hinge Screw

1. Unplug refrigerator or disconnect power.
2. Open refrigerator door and remove base grille from the bottom front of the refrigerator (see Base Grille graphic).
3. Close the refrigerator door and keep both doors closed until you are ready to lift them free from the cabinet.
NOTE: Provide additional support for the doors while the hinges are being moved. Do not depend on the door magnets to hold the doors in place while you are working.
4. Remove the parts for the top hinge as shown in Top Hinge graphic.
5. Lift the freezer door free from the cabinet.
6. Remove the parts for the center hinge as shown in the Center Hinge graphic.
7. Lift the refrigerator door free from the cabinet.
8. Remove the parts for the bottom hinge as shown in the Bottom Hinge graphic.

IMPORTANT: If you want to reverse your doors so that they open in the opposite direction, follow these steps. If you are not reversing the doors, see "Door and hinge replacement".

Door reversal (optional)



Door Stop Screw



Door Hinge Hole Plug



Door Handle Sealing Screw



Cabinet Hinge Hole Plug



Flat-Head Handle Screw



Door Handle Screw Cover



Door Handle Seal Screw Front



Round-Head Handle Screw

Cabinet

1. Remove 5/16 in hex head hinge screws from handle side and move them to opposite side (see Graphic 1-1).
2. Remove cabinet hinge hole plugs from cabinet top and move them to opposite side hinge holes as shown (see Graphic 1-2).

Freezer door

1. Remove freezer handle assembly as shown. Keep all parts together (see Graphic 2).
2. Remove door hinge hole plug. Move to opposite side as shown (see Graphic 3).
3. Remove door handle sealing screws. Move to opposite side of freezer door as shown (see Graphic 4).
4. Remove door stop. Move to opposite side of freezer door as shown (see Graphic 5).
5. Position freezer handle on opposite side of freezer door. Assemble handles on door as shown (see Graphic 2).
6. Tighten all screws. Set aside door until hinges and refrigerator compartment door are in place.

Refrigerator door

1. Remove refrigerator handle bottom trim. For **Style 1**, remove the handle screw cover (see Graphic 6-1). For **Style 2**, slide trim down as shown (see Graphic 6-2).
2. Remove refrigerator handle assembly as shown. Keep all parts together (see Graphic 6-3).
3. Remove door hinge hole plug from refrigerator door. Move to opposite side hinge hole as shown (see Graphic 3).
4. Remove door handle sealing screws. Move to opposite side of refrigerator door as shown (see Graphic 4).
5. Remove door handle seal screw front. Move to opposite side of refrigerator door as shown (see Graphic 7).
6. Remove door stop. Move to opposite side of refrigerator door as shown (see Graphic 5).
7. Position refrigerator handle on opposite side of the refrigerator door as shown (see Graphic 6-3). Drive top two screws in handle first. Align lower portion of handle and drive bottom screw.
8. Align refrigerator bottom trim. For **Style 1**, replace the door handle screw cover (see Graphic 6-1). For **Style 2**, slide trim into place (see Graphic 6-2).
9. Tighten all screws. Set aside refrigerator door until bottom hinge is installed on product.

Door and hinge replacement

Note: Graphic may be reversed if door swing is reversed.

1. Replace the parts for the bottom hinge as shown. Tighten screws.
2. Replace the refrigerator door.
NOTE: Provide additional support for the doors while the hinges are being moved. Do not depend on the door magnets to hold the doors in place while you are working.
3. Assemble the parts for the center hinge as shown and tighten all screws (see Center Hinge graphic).
4. Replace the freezer door.
5. Assemble the parts of the top hinge as shown (see Top Hinge graphic). Do not tighten screws completely.
6. Line up the doors so that the bottom of the freezer door aligns evenly with the top of the refrigerator door. Tighten all screws.

Final Steps

1. Check all holes to make sure that hole plugs and screws are in place. Reinstall top hinge cover (see Top Hinge graphic).
2. Replace the base grille (see Base Grille graphic).
3. Plug in refrigerator or reconnect power.
4. Reset the controls (see "Setting the Controls" section).
5. Return all removable door parts to doors and food to product.

Door Closing and Alignment

Door Closing

Your refrigerator has two front adjustable rollers – one on the right and one on the left. If your refrigerator seems unsteady or you want the doors to close easier, adjust the refrigerator's tilt using the instructions below:

1. Plug refrigerator power cord into a 3 prong grounded outlet. Move the refrigerator into its final position.
2. Remove the base grille (see "Base Grille" earlier in this section). The two leveling screws are part of the front roller assemblies which are at the base of the refrigerator on either side.

- Use a screwdriver to adjust the leveling screws. Turn the leveling screw to the right to raise that side of the refrigerator or turn the leveling screw to the left to lower that side. It may take several turns of the leveling screws to adjust the tilt of the refrigerator.

NOTE: Having someone push against the top of the refrigerator takes some weight off the leveling screws and rollers. This makes it easier to adjust the screws.

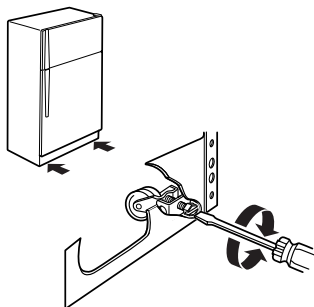

- Open both doors again and check to make sure that they close as easily as you like. If not, tilt the refrigerator slightly more to the rear by turning both leveling screws to the right. It may take several more turns, and you should turn both leveling screws the same amount.
- Replace the base grille.

Door Alignment

If the space between your doors looks uneven, you can adjust it using the instructions below:

- Pry off the top hinge cover.
- Loosen the top hinge screws using a $\frac{5}{16}$ -inch socket or wrench.
- Have someone hold the door in place or put a spacer between the doors while you tighten the top hinge screws.
- Replace the top hinge cover.

Understanding Sounds You May Hear

Your new refrigerator may make sounds that your old one didn't make. Because the sounds are new to you, you might be concerned about them. Most of the new sounds are normal. Hard surfaces, like the floor, walls, and cabinets, can make the sounds seem louder than they actually are. The following describes the kinds of sounds and what may be making them.

- If your product is equipped with an ice maker, you will hear a buzzing sound when the water valve opens to fill the ice maker for each cycle.
- The defrost timer will click when the automatic defrost cycle begins and ends. Also, the Thermostat Control (or Refrigerator Control depending on the model) will click when cycling on and off.
- Rattling noises may come from the flow of refrigerant, the water line, or items stored on top of the refrigerator.
- Your refrigerator is designed to run more efficiently to keep your food items at the desired temperature. The high efficiency compressor may cause your new refrigerator to run longer than your old one, and you may hear a pulsating or high-pitched sound.
- Water dripping on the defrost heater during a defrost cycle may cause a sizzling sound.

- You may hear the evaporator fan motor circulating the air through the refrigerator and freezer compartments.
- As each cycle ends, you may hear a gurgling sound due to the refrigerant flowing in your refrigerator.
- Contraction and expansion of the inside walls may cause a popping noise.
- You may hear air being forced over the condenser by the condenser fan.
- You may hear water running into the drain pan during the defrost cycle.

USING YOUR REFRIGERATOR

Ensuring Proper Air Circulation

In order to ensure proper temperatures, you need to permit airflow between the refrigerator and freezer sections. As shown in the illustration, cool air enters through the bottom of the freezer section and moves up. Most of the air then flows through the freezer section vents and recirculates under the freezer floor. The rest of the air enters the refrigerator section through the top vent.

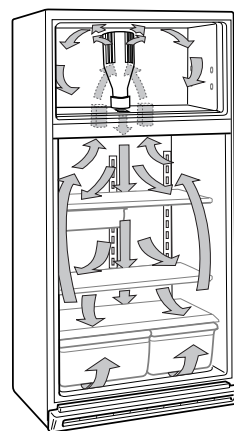

Do not block any of these vents with food packages. If the vents are blocked, airflow will be prevented and temperature and moisture problems may occur.

IMPORTANT: Because air circulates between both sections, any odors formed in one section will transfer to the other. You must thoroughly clean both sections to eliminate odors. To prevent odor transfer and drying out of food, wrap or cover foods tightly.

Setting the Control(s)

For your convenience, the refrigerator controls are preset at the factory. Controls for the refrigerator and freezer are located in the top of the refrigerator section.

When you first install your refrigerator, make sure that the control(s) are still preset. The control(s) should be at the "mid-settings" as shown for each style of control.

Mid-setting "3"

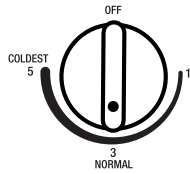

Mid-setting "3"

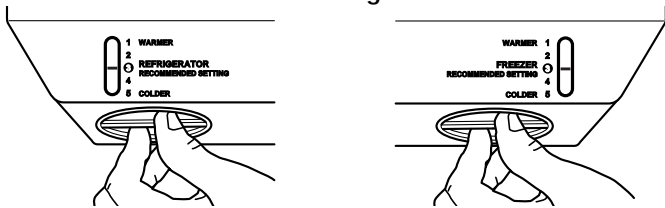

Mid-setting "4"

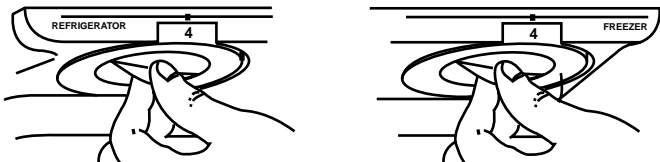

NOTE: To turn your refrigerator off, turn the refrigerator control to the word OFF or until the word OFF appears, as shown below. Your product will not cool when the refrigerator control is set to OFF.

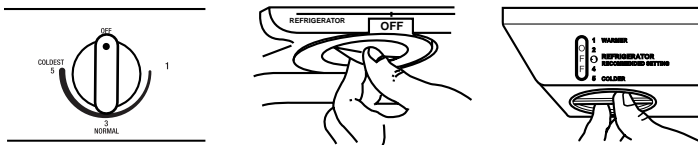

Give your refrigerator time to cool down completely before adding food. It is best to wait 24 hours before you put food into the refrigerator.

IMPORTANT: If you add food before the refrigerator has cooled completely, your food may spoil. **Turning the Refrigerator or Freezer Control(s) to a higher (colder) than recommended setting will not cool the compartments any faster.**

On models with two controls, the Freezer Control functions as an airflow director. Setting "1" will direct more of the cold air into the refrigerator section, while setting "5" (or "7" depending on your model) will direct more of the cold air into the freezer section. The cold air flows from the freezer compartment through the **top vent** into your fresh food section (see diagram in the "Ensuring Proper Air Circulation" section). On models with one control, the airflow does not require adjustment.

Adjusting Control Settings

Give the refrigerator time to cool down completely before adding food. It is best to wait 24 hours before you put food into the refrigerator. The "mid-settings" indicated in the previous section should be correct for normal household refrigerator usage. The controls are set correctly when milk or juice is as cold as you like and when ice cream is firm.

For models with two controls:

The Refrigerator Control functions as the thermostat for the entire product (refrigerator and freezer sections). The higher the number setting, the longer the compressor will run to keep the temperature colder. The Freezer Control adjusts the cold air flow from the freezer to the refrigerator.

If you need to adjust temperatures in the refrigerator or freezer, start by adjusting the refrigerator first. Wait 24 hours after the refrigerator adjustment to check the freezer temperature. If it is too warm or too cold, then adjust the Freezer Control as well.

For models with a single control:

The Temperature Control functions as the thermostat for the entire product (refrigerator and freezer sections). The higher the number setting, the longer the compressor will run to keep the temperature colder.

Use the settings listed in the chart below as a guide. **Always remember to wait at least 24 hours between adjustments.**

CONDITION/REASON:	RECOMMENDED ADJUSTMENT:
REFRIGERATOR section too warm <ul style="list-style-type: none"> ■ Door opened often ■ Large amount of food added ■ Room temperature very warm 	Turn REFRIGERATOR Control or TEMPERATURE Control to next higher number, wait 24 hours, then re-check
<ul style="list-style-type: none"> ■ Blocked air stream 	Move items out of air stream
FREEZER section too warm/ice not made fast enough <ul style="list-style-type: none"> ■ Door opened often ■ Large amount of food added ■ Very cold room temperature (can't cycle often enough) ■ Heavy ice usage ■ Blocked air stream 	Turn FREEZER Control or TEMPERATURE Control to next higher number, wait 24 hours, then re-check
	Move items out of air stream

CONDITION/REASON:	RECOMMENDED ADJUSTMENT:
REFRIGERATOR section too cold <ul style="list-style-type: none"> ■ Controls not set correctly for your conditions ■ Blocked air stream 	Turn REFRIGERATOR Control or TEMPERATURE Control to next lower number, wait 24 hours, then re-check Move items out of air stream
FREEZER section too cold <ul style="list-style-type: none"> ■ Controls not set correctly for your conditions ■ Blocked air stream 	Turn FREEZER Control or TEMPERATURE Control to next lower number, wait 24 hours, then re-check Move items out of air stream

REFRIGERATOR FEATURES

Your model may have some or all of these features. Features that can be purchased separately as product accessories are labeled with the word "Accessory." Not all accessories will fit all models. If you are interested in purchasing one of the accessories, please call the toll-free number on the cover or in the "Assistance or Service" section.

Refrigerator Shelves

The shelves in your refrigerator are adjustable to meet your individual storage needs. Your model may have glass or wire shelves.

Storing similar food items together in your refrigerator and adjusting the shelves to fit different heights of items will make finding the exact item you want easier. It will also reduce the amount of time the refrigerator door is open, and save energy.

IMPORTANT: Do not clean glass shelves with warm water when they are cold. Shelves may break if exposed to sudden temperature changes or impact, such as bumping. For your protection, tempered glass is designed to shatter into many small pebble-size pieces. This is normal.

NOTE: Glass shelves are heavy. Use special care when removing them to avoid impact from dropping.

Slide-out Shelves (on some models)

- To slide out shelf, carefully pull front of shelf toward you.
- To slide in shelf, push shelf in until it stops.

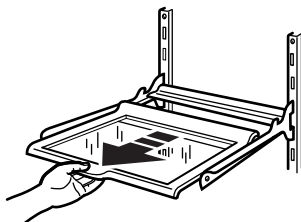

To remove and replace a shelf in a metal frame:

1. Pull the shelf forward to the stop.
2. Tilt the front of the shelf up and lift it slightly as you pull the shelf from the frame.

3. Replace the shelf by guiding it back into the slots on the frame and pushing the shelf in past the stop.

Shelves and Shelf Frames

To remove and replace a shelf/frame:

1. Remove the shelf/frame by tilting it up at the front and lifting it out of the shelf supports.
2. Replace the shelf/frame by guiding the rear shelf hooks into the shelf supports. Tilt the front of the shelf up until rear shelf hooks drop into the shelf supports.
3. Lower the front of the shelf and check to make sure that the shelf is securely in position.

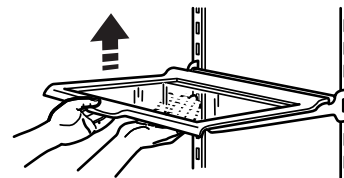

Lateral Adjustable Shelf (on some models)

To slide the shelf from side to side:

1. Lift up on the front of shelf and slide to the desired location.
2. Lower shelf to the level position.

NOTE: You do not have to remove small items from the shelf before moving it from side to side. You may need to remove larger items.

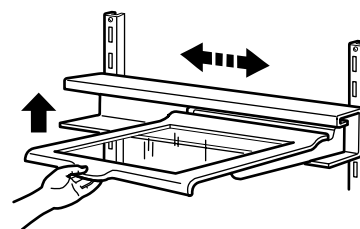

To remove the shelf:

NOTE: The shelf is heavy and must be removed using both hands.

1. Hold the back of the shelf with one hand.
2. Lift the front of the shelf with the other hand to a 45° angle and lower it slightly to release it from the upper channel of the track. Pull the shelf straight out.

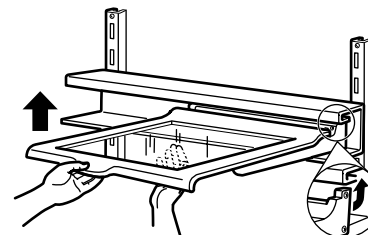

To remove and replace the shelf track:

1. Remove the shelf track by lifting both sides of the track slightly and pulling the track straight out.
2. Replace the track by guiding the track hooks into the shelf support slots on the back wall.

NOTE: Make sure that both sets of track hooks are in the slots and that the slots are parallel with each other.

3. Push the track back and down securely into the shelf supports.

To replace the shelf:

NOTE: Make sure that both of the rear shelf slides are securely in the track before letting go of the shelf. The lateral shelf may be difficult to install if the track is placed too close to the refrigerator ceiling. Reposition the track on a lower rung until the shelf can be tilted enough to easily slide into the track.

1. Hold the shelf at the front and tip the front at a 45° angle to the track.
2. Insert both of the rear shelf slides into the upper channel of the track, and lower the front of the shelf into place.

Meat Drawer and Cover (on some models)

To remove and replace the meat drawer (all styles):

1. Remove the meat drawer by sliding it out to the stop. Lift the front of meat drawer with one hand while supporting the bottom of drawer with other hand. Slide drawer out the rest of the way.
2. Replace the meat drawer by guiding it into the meat cover supports and pushing it in until it stops.

To remove and replace the meat drawer cover (Style 1 glass):

1. Remove the meat drawer. Remove the cover by tilting up the front of the cover and lifting at the back. Pull the cover straight out.
2. Replace the cover by guiding the rear hooks into the shelf supports. Tilt the cover up at the front until the rear hooks drop into the slots.
3. Lower the front of the cover to a level position and replace the meat drawer.

IMPORTANT: Do not clean glass meat drawer covers with warm water when they are cold. Glass meat drawer covers may break if exposed to sudden temperature changes or impact, such as bumping. For your protection, tempered glass is designed to shatter into many small pebble-size pieces. This is normal.

NOTE: Glass meat drawer covers are heavy. Use special care when removing them to avoid impact from dropping.

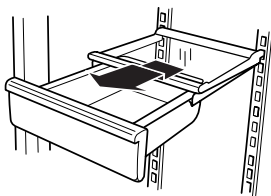

To remove and replace the meat drawer cover (Style 2 plastic):

1. Remove the meat drawer. Tilt the cover up at the front and pull it forward and out.
2. Replace the meat drawer cover by fitting the notches and rear edge of the cover over rear and center crossbars on the shelf.
3. Lower cover into place and replace the meat drawer.

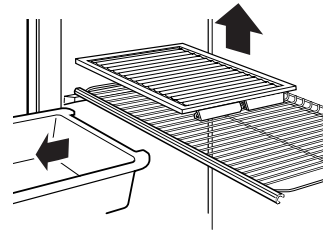

Chilled Meat Drawer (on some models)

To adjust the meat drawer temperature:

- Slide the meat drawer temperature control forward to make the meat drawer less cold.
- Slide the meat drawer temperature control backward to make the meat drawer colder.

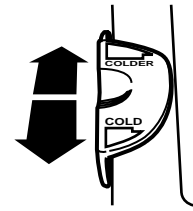

Meat storage guide

Store most meat in original wrapping as long as it is airtight and moisture-proof. Rewrap if necessary. See the following chart for storage times. When storing meat longer than the times given, freeze the meat.

Fresh fish or shellfish.....	use same day as purchased
Chicken	1-2 days
Ground beef	1-2 days
Variety meats (liver, heart, etc.).....	1-2 days
Cold cuts	3-5 days
Steaks/roasts	3-5 days
Cured meats.....	7-10 days
Leftovers - Cover leftovers with plastic wrap, aluminum foil, or plastic containers with tight lids.	

Crisper and Crisper Cover

(on some models - Accessory)

To remove and replace the crisper(s):

1. Slide crisper(s) straight out to the stop. Lift the front of the crisper(s) and slide out the rest of the way.
2. Replace the crisper(s) by sliding back in fully past the drawer stop.

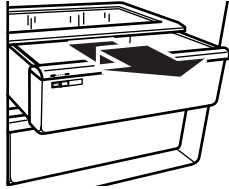

IMPORTANT: Do not clean glass crisper covers with warm water when they are cold. Glass crisper covers may break if exposed to sudden temperature changes or impact, such as bumping. For your protection tempered glass is designed to shatter into many small pebble-size pieces. This is normal.

NOTE: Glass crisper covers are heavy. Use special care when removing them to avoid impact from dropping.

To remove the crisper(s) cover:

1. Remove crisper(s).
2. Holding the glass insert firmly with one hand, press up in center of glass insert until it rises above the plastic frame. Carefully, slide the glass insert forward to remove.
3. Lift the cover frame up and remove it.

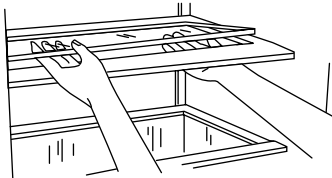

To replace crisper(s) cover:

NOTE: Before reinstalling the cover, make sure the U-shaped reinforcement bar is reinstalled in the front edge of the crisper cover.

1. Fit back of cover frame into supports on side walls of the refrigerator and lower the front of the cover frame into place.
2. Slide rear of glass insert into cover frame and lower front into place.

Crisper Humidity Control

(on some models)

You can control the amount of humidity in the moisture-sealed crisper. Adjust the control to any setting between LOW and HIGH.

- **LOW (open)** lets moist air out of the crisper for best storage of fruits and vegetables with skins.

Fruit: Wash, let dry and store in refrigerator in plastic bag or crisper. Do not wash or hull berries until they are ready to use. Sort and keep berries in original container in crisper, or store in a loosely closed paper bag on a refrigerator shelf.

Vegetables with skins: Place in plastic bags or plastic container and store in crisper.

- **HIGH (closed)** keeps moist air in the crisper for best storage of fresh, leafy vegetables.

Leafy vegetables: Wash in cold water, drain and trim or tear off bruised and discolored areas. Place in plastic bag or plastic container and store in crisper.

Humidity control location:

- Humidity Control on crisper drawer (Style 1 - on left)
- Humidity Control on crisper cover (Style 2 - on right)

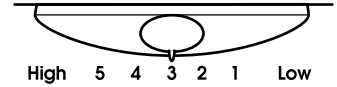
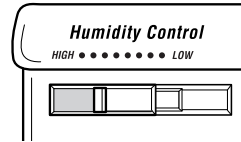

Utility or Egg Bin

(on some models - Accessory)

Remove the cover and place the eggs in the egg tray. If you prefer, you can remove the egg tray and place the entire carton of eggs in the bin. Replace the cover.

NOTE: Eggs should be stored in a covered container. If your model does not have an egg bin or covered utility bin, store eggs in their original container on an interior shelf.

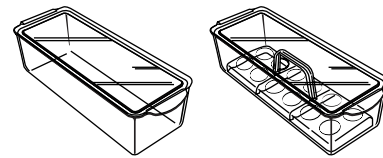

Wine or Can/Bottle Rack

(on some models - Accessory)

To remove and replace the wine rack (left) or can/bottle rack (right):

1. Remove the rack by pulling it straight out from the shelf.
2. Replace the rack by sliding it in between the shelf and the wall of the refrigerator.

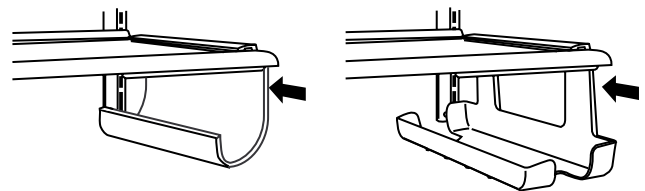

FREEZER FEATURES

Your model may have some or all of these features. Features that can be purchased separately as product accessories are labeled with the word "Accessory." Not all accessories will fit all models. If you are interested in purchasing one of the accessories, please call the toll-free number on the cover or in the "Assistance or Service" section.

Ice Maker

(on some models - Accessory)

There are two styles of ice makers:

- Normal (Style 1 - on left)
- Maximum Ice (Style 2 - on right)

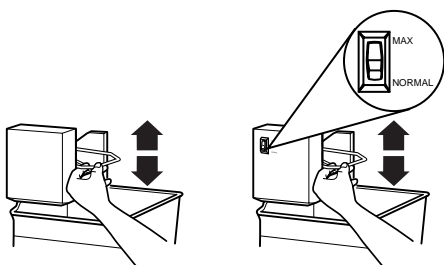

To turn the ice maker on:

The on/off switch for the ice maker is a wire shut-off arm located on the side of the ice maker. To turn the ice maker on, simply lower the wire shut-off arm.

NOTE: The ice maker will not make ice until the freezer is cold enough. Allow 24 hours to produce the first batch of ice. Discard the first three batches of ice produced.

To turn the ice maker off:

- Automatic turn off: As ice is made, the ice cubes will fill the ice storage bin, and the ice cubes will raise the wire shut-off arm to the OFF (arm up) position.
- Manual turn off: Lift the wire shut-off arm to the OFF (arm up) position and listen for the click to make sure the ice maker will not continue to operate.

To increase ice production rate:

- Maximum Ice Production (on some models): In maximum ice production, the ice maker should produce approximately 16 to 20 batches of ice in a 24-hour period. If your refrigerator has the maximum ice production feature, push the switch to MAX.
- Normal Ice Production: In normal ice production mode, the ice maker should produce approximately 8 to 12 batches of ice in a 24-hour period. If ice is not being made fast enough, turn the Freezer Control toward a higher (colder) number in half number steps. (For example, if the control is at 3, move it to between 3 and 4.) Wait 24 hours and, if necessary, gradually turn the Freezer Control to the highest setting, waiting 24 hours between each increase.

REMEMBER:

- Allow 24 hours to produce the first batch of ice.
- Discard the first three batches of ice produced to avoid impurities that may be flushed out of the system.
- The quality of your ice will be only as good as the quality of the water supplied to your ice maker.

- Avoid connecting the ice maker to a softened water supply. Water softener chemicals (such as salt) can damage parts of the ice maker and lead to poor quality ice. If a softened water supply cannot be avoided, make sure the water softener is operating properly and is well maintained.
- It is normal for the ice cubes to be attached at the corners. They will break apart easily.
- Do not force the wire shut-off arm up or down.
- Do not store anything on top of the ice maker or in the ice storage bin.

Freezer Shelf

(on some models)

To remove the shelf:

1. Lift entire shelf slightly.
2. Move shelf all the way to one side.
3. Tilt other side up and out of shelf supports.
4. Pull shelf up and out

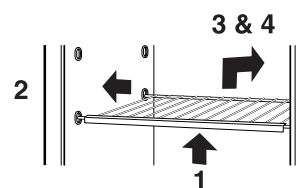

To replace the shelf:

1. Tilt the shelf and insert into freezer compartment.
2. Insert one end of the shelf all the way into the center of the shelf supports.
3. Lower other end of shelf and insert into the shelf supports.
4. Lower shelf into place.

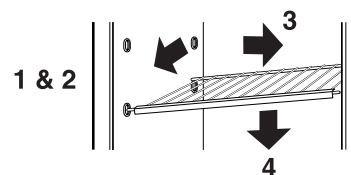

NOTE: The shelf should lower slightly and lock into place. If the shelf does not appear stable, make sure both ends of the shelf are inserted into the shelf supports.

Frozen food storage guide

Storage times will vary according to the quality and type of food, the type of packaging or wrap used (should be airtight and moisture-proof), and the storage temperature. Seal the package or container securely to prevent taste and odor transfer throughout the product. Ice crystals inside a sealed package are normal. This simply means that moisture in the food and air inside the package have condensed, creating ice crystals.

Put no more unfrozen food into the freezer than will freeze within 24 hours (no more than 2-3 lb of food per cubic foot [907-1,350 g per L] of freezer space). Leave enough space in the freezer for air to circulate around packages. Be careful to leave enough room for the door to close tightly.

NOTE: For more information on preparing food for freezing, check a freezer guide or reliable cookbook.

Adjustable Half-width Freezer Shelf

(on some models)

To remove and replace the shelf:

1. Remove the shelf by lifting the shelf up and pulling straight out.
2. Replace the shelf over the supports and lower it into place.

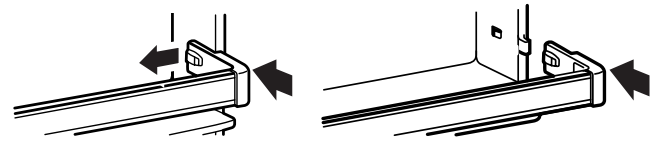
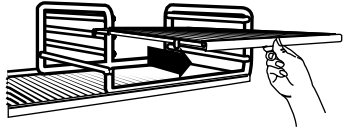

Drop-in Door Rails

To remove and replace the rails:

1. Remove the rails by pulling straight up on each end of the rail.
2. Replace the rails by sliding the shelf rail into the slots on the door and pushing the rail straight down until it stops.

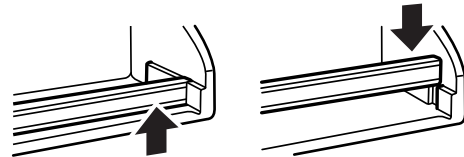

Pull-out Freezer Floor

(on some models)

To remove and replace the freezer floor:

1. Lift both back "fences" up and out.
2. Remove the freezer floor by pulling it out about 1 in (25.40 mm) with one hand around the air tower section (center back) and one hand at center front.
3. Lift up floor at rear until hooks release from cabinet and pull the floor out the rest of the way.
4. Replace the freezer floor by sliding the floor straight in until the hooks drop into place at rear of cabinet.
5. Replace "fences" by aligning pins with socket in the floor, and pushing down until they snap into place.

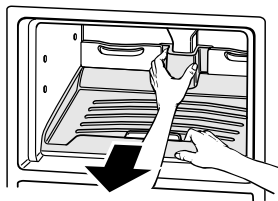

Door Bins

(on some models)

To remove and replace the bins:

1. Remove the bin by lifting it up and pulling it straight out.
2. Replace the bin by sliding it in above the desired support and pushing it down until it stops.

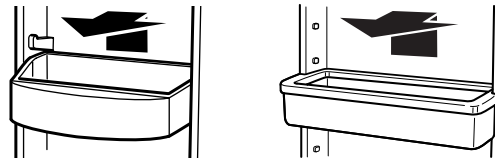

DOOR FEATURES

Your model may have some or all of these features. Features that can be purchased separately as product accessories are labeled with the word "Accessory." Not all accessories will fit all models. If you are interested in purchasing one of the accessories, please call the toll-free number on the cover or in the "Assistance or Service" section.

Door Rails

The door rails may be removed for easier cleaning.

Snap-on Door Rails

To remove and replace the rails:

1. Remove the rails by pushing in slightly on the front of the bracket while pulling out on the inside tab. Repeat these steps for the other end of the rail.
2. Replace the rails by aligning the ends of the brackets with the buttons on the sides of the door liner. Firmly snap bracket and rail assembly onto the tabs above the shelf as shown.

Can Rack

(on some models - Accessory)

To remove and replace the rack:

1. Remove the rack by lifting it up and pulling straight out.
2. Replace the rack by holding it above the desired support and pushing the rack back and down until it stops.

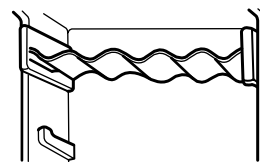

Adjustable Utility Compartment & Tray

(on some models)

The utility compartment and tray slide from one side to the other for more flexible storage. The tray fits on either side of the utility compartment or partially underneath it. Try moving it to different positions to find the option that works best for you.

To install the utility compartment and tray:

1. Insert the front of the utility tray into the slot on the back of the shelf rail. Lower the back of the tray into position.

- Place the front of the utility compartment on top of the shelf rail. Lower the back of the compartment onto the ribs on the refrigerator door.

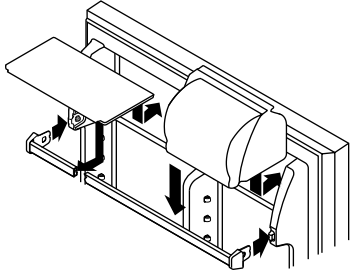

To adjust the utility compartment or tray:

- Lift the front slightly and slide to desired position.
- Lower front to lock into place.

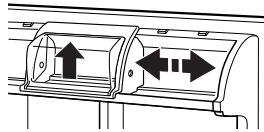

Flip-up Door Shelf
(on some models)

The shelf bottom flips up so you can store taller items in the door shelf below. When in the down position, the shelf is strong enough to hold up to 10 pounds (4.5 kg).

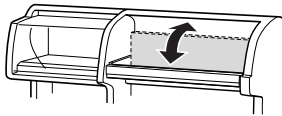

CARING FOR YOUR REFRIGERATOR

Cleaning Your Refrigerator

⚠ WARNING

Explosion Hazard

Use nonflammable cleaner.

Failure to do so can result in death, explosion, or fire.

Both the refrigerator and freezer sections defrost automatically. However, clean both sections about once a month to prevent odors from building up. Wipe up spills immediately.

To clean your refrigerator:

- Unplug refrigerator or disconnect power.
- Remove all removable parts from inside, such as shelves, crispers, etc.
- Hand wash, rinse, and dry removable parts and interior surfaces thoroughly. Use a clean sponge or soft cloth and a mild detergent in warm water.
 - Do not use abrasive or harsh cleaners such as window sprays, scouring cleansers, flammable fluids, cleaning waxes, concentrated detergents, bleaches or cleansers containing petroleum products on plastic parts interior and door liners or gaskets.
 - Do not use paper towels, scouring pads, or other harsh cleaning tools. These can scratch or damage materials.
 - To help remove odors, you can wash interior walls with a mixture of warm water and baking soda (2 tbs to 1 qt [26 g to .95 L] of water).
- Wash stainless steel and painted metal exteriors with a clean sponge or soft cloth and a mild detergent in warm water. Do not use abrasive or harsh cleaners. Dry thoroughly with a soft cloth.

For additional protection against damage to painted metal exteriors, apply appliance wax (or auto paste wax) with a clean, soft cloth. Do not wax plastic parts.
- Clean the condenser coils regularly. Coils may need to be cleaned as often as every other month. This may help save energy.

Style 1 - Condenser coils behind base grille:

- Remove the base grille (see the "Base Grille" section).
- Use a vacuum with an extended attachment to clean the condenser coils when they are dusty or dirty.
- Replace the base grille when finished.

Style 2 - Condenser coils in back of the refrigerator:

- Pull refrigerator out away from the wall (see the "Unpacking Your Refrigerator" section).
- Vacuum coils when they are dusty or dirty.
- Roll refrigerator back into place. Make sure to leave 1 in. (2.5 cm) between the cabinet back and the wall.
- Check to see if the refrigerator is level.

- Plug in refrigerator or reconnect power.

Changing the Light Bulbs

NOTE: Not all appliance bulbs will fit your refrigerator. Be sure to replace the bulb with one of the same size, shape, and wattage.

To change the refrigerator light:

- Unplug refrigerator or disconnect power.
- Reach behind the Control Panel and unscrew the bulb.
- Replace the bulb with an appliance bulb of the same wattage.
- Plug in refrigerator or reconnect power.

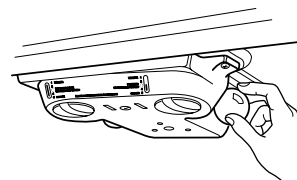

To change freezer light:
(on some models)

- Unplug refrigerator or disconnect power.
- Reach behind light shield to remove bulb.
- Replace bulb with a 40-watt appliance bulb.

4. Plug in refrigerator or reconnect power.

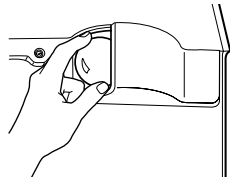

Power Interruptions

If the electricity in your house goes off, call the power company and ask how long it will be off.

1. If the power will be out for **24 hours or less**, keep both **refrigerator doors closed** to help food stay cold and frozen.
2. If the power will be out for **more than 24 hours**:
 - a) Remove all frozen food and store it in a frozen food locker.
OR
 - b) Place 2 lbs (907 g) of dry ice in the freezer for every cubic foot (28 L) of freezer space. This will keep the food frozen for two to four days.
OR
 - c) If neither a food locker nor dry ice is available, consume or can perishable food at once.

REMEMBER: A full freezer stays cold longer than a partially filled one. A freezer full of meat stays cold longer than a freezer full of baked goods. If you see that food contains ice crystals, it may be refrozen, although the quality and flavor may be affected. If the condition of the food is poor, dispose of it.

Vacation and Moving Care

Vacations

If you choose to leave the refrigerator on while you're away, use these steps to prepare your refrigerator before you leave.

1. Use up any perishables and freeze other items.
2. If your refrigerator has an automatic ice maker:
 - Raise wire shut-off arm to OFF (up) position or move the switch to the OFF (right) setting.
 - Shut off water supply to the ice maker.
3. Empty the ice bin.

If you choose to turn the refrigerator off before you leave, follow these steps.

1. Remove all food from the refrigerator.
2. If your refrigerator has an automatic ice maker:
 - Turn off the water supply to the ice maker at least one day ahead of time.
 - When the last load of ice drops, raise the wire shut-off arm to the OFF (up) position or move the switch to the OFF (right) setting.
3. Depending on your model, turn the Thermostat Control or Refrigerator Control to OFF. See the "Setting the Controls" section.
4. Clean refrigerator, wipe it, and dry well.
5. Tape rubber or wood blocks to the tops of both doors to prop them open far enough for air to get in. This stops odor and mold from building up.

Moving

When you are moving your refrigerator to a new home, follow these steps to prepare it for the move.

1. If your refrigerator has an automatic ice maker:
 - Turn off the water supply to the ice maker at least one day ahead of time.

- Disconnect the water line from the back of the refrigerator.
 - When the last load of ice drops, raise the wire shut-off arm to the OFF (up) position or move the switch to the OFF (right) setting.
2. Remove all food from the refrigerator and pack all frozen food in dry ice.
 3. Depending on your model, turn the Thermostat Control or Refrigerator Control to OFF. See the "Setting the Controls" section.
 4. Unplug the refrigerator.
 5. Empty water from the defrost pan.
 6. Clean, wipe, and dry thoroughly.
 7. Take out all removable parts, wrap them well, and tape them together so they don't shift and rattle during the move.
 8. Depending on the model, raise the front of the refrigerator so it rolls more easily OR screw in the leveling legs so they don't scrape the floor. See the "Door Closing" or "Leveling Your Refrigerator" section, depending on your model.
 9. Tape the doors shut and the power cord to the refrigerator cabinet.

When you get to your new home, put everything back and refer to the "Installing Your Refrigerator" section for preparation instructions. Also, if your refrigerator has an automatic ice maker, remember to reconnect the water supply to the refrigerator.

TROUBLESHOOTING

Try the solutions suggested here first in order to avoid the cost of an unnecessary service call.

Your refrigerator will not operate

- **Is the power supply cord unplugged?**
Firmly plug the cord into a live outlet with proper voltage.
 - **Has a household fuse or circuit breaker tripped?**
Replace the fuse or reset the circuit.
 - **Is the Refrigerator Control turned to the OFF position?**
Refer to the "Setting the Control(s)" section.
 - **Is the refrigerator defrosting?**
Recheck to see if the refrigerator is operating in 30 minutes. Your refrigerator will regularly run an automatic defrost cycle.
-

The lights do not work

- **Is the power supply cord unplugged?**
Firmly plug the cord into a live outlet with proper voltage.
- **Is a light bulb loose in the socket?**
Turn the refrigerator control to OFF. Disconnect the refrigerator from the electrical supply. Gently remove the bulb and reinsert. Then reconnect the refrigerator to the electrical supply and reset the refrigerator control.
- **Has a light bulb burned out?**
Replace with an appliance bulb of the same wattage, size, and shape. See the "Changing the Light Bulb(s)" section.

There is water in the defrost drain pan

- **Is the refrigerator defrosting?**
The water will evaporate. It is normal for water to drip into the defrost pan.
- **Is it more humid than normal?**
Expect that the water in the defrost pan will take longer to evaporate. This is normal when it is hot or humid.

The motor seems to run too much

- **Is the room temperature hotter than normal?**
Expect the motor to run longer under warm conditions. At normal room temperatures, expect your motor to run about 40% to 80% of the time. Under warmer conditions, expect it to run even more of the time.
- **Has a large amount of food just been added to the refrigerator?**
Adding a large amount of food warms the refrigerator. It is normal for the motor to run longer in order to cool the refrigerator back down. See the "Refrigerator Features" section.
- **Are the doors opened often?**
Expect the motor to run longer when this occurs. In order to conserve energy, try to get everything you need out of the refrigerator at once, keep food organized so it is easy to find, and close the door as soon as the food is removed.
- **Is the control set correctly for the surrounding conditions?**
Refer to the "Setting the Control(s)" section.
- **Are the doors closed completely?**
Push the doors firmly shut. If they will not shut all the way, see "The doors will not close completely" later in this section.
- **Are the condenser coils dirty?**
This prevents air transfer and makes the motor work harder. Clean the condenser coils. Refer to the "Cleaning Your Refrigerator" section.

NOTE: Your new refrigerator will run longer than your old one due to its high efficiency motor.

The refrigerator seems to make too much noise

- **The sounds may be normal for your refrigerators.**
Refer to the "Understanding Sounds You May Hear" section.

The ice maker is not producing ice

- **Is the freezer temperature cold enough to produce ice?**
Wait 24 hours after hook-up for ice production. See the "Setting the Control(s)" section.
- **Is the wire shut-off arm in the OFF (arm up) position?**
Lower the wire shut-off arm to the ON (arm down) position. See the "Ice Maker Operation" section.
- **Is the water line shut-off valve to the refrigerator turned on?**
Turn on the water valve. See the "Connecting the Refrigerator to a Water Source" section.

- **Is an ice cube jammed in the ejector arm?**
Remove the ice from the ejector arm with a plastic utensil. Refer to the "Ice Maker Operation" section.
- **Does the ice maker mold have water in it or has no ice been produced?**
Check to see if your refrigerator has been connected to your home water supply and the supply shut-off valve is turned on. Refer to the "Connecting the Refrigerator to a Water Source" section.

NOTE: If not due to any of the above, there may be a problem with the water line. Call for service.

The ice maker is producing too little ice

- **Has the ice maker just been installed?**
Wait 72 hours for full ice production to begin. Once your refrigerator is cooled down, the ice maker should begin producing 70-120 cubes every 24 hours.
- **Has a large amount of ice just been removed?**
Allow 24 hours for ice maker to produce more ice.
- **Is the control set correctly?**
Refer to the "Setting the Control(s)" section.
- **Is the water shut-off valve turned completely on?**
Turn valve on fully. Refer to the "Connecting the Refrigerator to a Water Source" section.
- **Is there a water filter installed on the refrigerator? This filter may be clogged or installed incorrectly.**
First, check the filter installation instructions to ensure that the filter was installed correctly and is not clogged. If installation or clogging is not a problem, call a qualified person or a technician.

Off-taste or odor in the ice

- **Are the plumbing connections new, causing discolored or off-flavored ice?**
Discard the first few batches of ice.
- **Have the ice cubes been stored for too long?**
Throw old ice away and make a new supply.
- **Has food in the refrigerator been wrapped properly?**
Refer to the "Refrigerator Features" section.
- **Do the freezer and ice bin need to be cleaned?**
See the "Cleaning Your Refrigerator" section.
- **Does the water contain minerals (such as sulfur)?**
A filter may need to be installed to remove the minerals.

The divider between the two compartments is warm

The warmth is probably due to normal operation of the automatic exterior moisture control.

Temperature is too warm

- **Are the air vents blocked in either compartment? This prevents the movement of cold air from the freezer to the refrigerator.**
Remove any objects from in front of the air vents. Refer to "Ensuring Proper Air Circulation" for the location of air vents.
- **Are the door(s) opened often?**
Be aware that the refrigerator will warm when this occurs. In order to keep the refrigerator cool, try to get everything you need out of the refrigerator at once, keep food organized so it is easy to find, and close the door as soon as the food is removed.

- **Has a large amount of food just been added to the refrigerator or freezer?**
Adding a large amount of food warms the refrigerator. It can take several hours for the refrigerator to return to the normal temperature.
- **Is the control set correctly for the surrounding conditions?**
Refer to the "Setting the Control(s)" section.

There is interior moisture build-up

- **Are the air vents blocked in the refrigerator?**
Remove any objects from in front of the air vents. Refer to "Ensuring Proper Air Circulation" for the location of air vents.
- **Is the door opened often?**
To avoid humidity build-up, try to get everything you need out of the refrigerator at once, keep food organized so it is easy to find, and close the door as soon as the food is removed. (When the door is opened, humidity from the room air enters the refrigerator. The more often the door is opened, the faster humidity builds up, especially when the room itself is very humid.)
- **Is the room humid?**
It is normal for moisture to build up inside the refrigerator when the room air is humid.
- **Is the food packaged correctly?**
Check that all food is securely wrapped. If necessary, repackage food according to the guidelines in the "Refrigerator Features" section. Wipe off damp food containers before placing in the refrigerator.
- **Is the control set correctly for the surrounding conditions?**
Refer to the "Setting the Control(s)" section.
- **Was a self-defrost cycle completed?**
It is normal for droplets to form on the back wall after the refrigerator self-defrosts.

The doors are difficult to open

- **Are the gaskets dirty or sticky?**
Clean gaskets and the surface that they touch. Rub a thin coat of paraffin wax on the gaskets following cleaning.

The doors will not close completely

- **Are food packages blocking the door open?**
Rearrange containers so that they fit more tightly and take up less space.
- **Is the ice bin out of position?**
Push the ice bin in all the way.
- **Are the crisper cover, pans, shelves, bins, or baskets out of position?**
Put the crisper cover and all pans, shelves, bins, and baskets back into their correct positions. See the "Refrigerator Features" section for more information.
- **Are the gaskets sticking?**
Clean gaskets and the surface that they touch. Rub a thin coat of paraffin wax on the gaskets following cleaning.
- **Does the refrigerator wobble or seem unstable?**
Level the refrigerator. Refer to the "Door Closing and Alignment" section.
- **Were the doors removed during product installation and not properly replaced?**
Remove and replace the doors according to the "Refrigerator Doors: Removing, Reversing (optional) and Replacing" section, or call a qualified service technician.

ASSISTANCE OR SERVICE

Before calling for assistance or service, please check "Troubleshooting." It may save you the cost of a service call. If you still need help, follow the instructions below.

When calling, please know the purchase date and the complete model and serial number of your appliance. This information will help us to better respond to your request.

If you need replacement parts

If you need to order replacement parts, we recommend that you only use factory specified replacement parts. Factory specified replacement parts will fit right and work right because they are made with the same precision used to build every new KIRKLAND SIGNATURE™ appliance.

To locate factory specified replacement parts in your area, call our Consumer Assistance Center telephone number or your nearest designated service center.

In the U.S.A.

Call the Whirlpool Consumer Assistance Center toll free: **1-800-253-1301**.

Our consultants provide assistance with:

- Features and specifications on our full line of appliances.
- Installation information.
- Use and maintenance procedures.
- Accessory and repair parts sales.
- Specialized customer assistance (Spanish speaking, hearing impaired, limited vision, etc.).
- Referrals to local dealers, repair parts distributors, and service companies. Whirlpool designated service technicians are trained to fulfill the product warranty and provide after-warranty service, anywhere in the United States.

To locate the Whirlpool designated service company in your area, you can also look in your telephone directory Yellow Pages.

For further assistance

If you need further assistance, you can write to Whirlpool Corporation with any questions or concerns at:

Whirlpool Brand Home Appliance
Consumer Assistance Center
c/o Correspondence Dept.
for KIRKLAND SIGNATURE™ Products
2000 North M-63
Benton Harbor, MI 49022-2692

Please include a daytime phone number in your correspondence.

REFRIGERATOR WARRANTY

TWO-YEAR FULL WARRANTY ON REFRIGERATOR MANUFACTURED FOR COSTCO WHOLESALE CORPORATION BY WHIRLPOOL CORPORATION

For two years from the date of purchase, when this refrigerator (excluding the water filter) is operated and maintained according to instructions attached to or furnished with the product, Whirlpool Corporation will pay for factory specified parts and repair labor costs to correct defects in materials or workmanship. Service must be provided by a Whirlpool designated service company.

On models with water filter: 30 day limited warranty on water filter. For 30 days from the date of purchase, when this filter is operated and maintained according to instructions attached to or furnished with the product, Whirlpool Corporation will pay for replacement parts to correct defects in materials and workmanship.

FIVE-YEAR FULL WARRANTY ON SEALED REFRIGERATION SYSTEM

For five years from the date of purchase, when this refrigerator is operated and maintained according to instructions attached to or furnished with the product, Whirlpool Corporation will pay for factory specified parts and repair labor costs to correct defects in materials or workmanship in the sealed refrigeration system. These parts are: compressor, evaporator, condenser, dryer, and connecting tubing. Service must be provided by a Whirlpool designated service company.

Whirlpool Corporation will not pay for:

1. Service calls to correct the installation of your refrigerator, to instruct you how to use your refrigerator, to replace house fuses or correct house wiring or plumbing, to replace light bulbs, or replacement water filters other than as noted above.
 2. Repairs when your refrigerator is used in other than normal, single-family household use.
 3. Pickup and delivery. Your refrigerator is designed to be repaired in the home.
 4. Damage resulting from accident, alteration, misuse, abuse, fire, flood, improper installation, acts of God, or use of products not approved by Whirlpool Corporation.
 5. Any food loss due to product failure.
 6. Repairs to parts or systems resulting from unauthorized modifications made to the appliance.
 7. Replacement parts or repair labor costs for units operated outside the United States.
-

WHIRLPOOL CORPORATION SHALL NOT BE LIABLE FOR INCIDENTAL OR CONSEQUENTIAL DAMAGES

Some states do not allow the exclusion or limitation of incidental or consequential damages, so this exclusion or limitation may not apply to you. This warranty gives you specific legal rights, and you may also have other rights which vary from state to state.

Outside the 50 United States, this warranty does not apply. Contact your authorized Whirlpool dealer to determine if another warranty applies.

Whirlpool Corporation is responsible for providing any in-warranty service covered in this warranty. If you need service, first see the "Troubleshooting" section of this book. After checking "Troubleshooting," additional help can be found by checking the "Assistance or Service" section or by calling the Whirlpool Consumer Assistance Center, 1-800-253-1301 (toll-free), from anywhere in the U.S.A. or writing: Whirlpool Brand Home Appliance, Consumer Assistance Center, c/o Correspondence Dept. for KIRKLAND SIGNATURE™ Products, 2000 North M-63, Benton Harbor, MI 49022-2692

11/99

Keep this book and your sales slip together for future reference. You must provide proof of purchase or installation date for in-warranty service.

Write down the following information about your refrigerator to better help you obtain assistance or service if you ever need it. You will need to know your complete model number and serial number. You can find this information on the model and serial number label located on the inside wall of the refrigerator compartment.

Dealer name _____

Address _____

Phone number _____

Model number _____

Serial number _____

Purchase date _____

DISTRIBUTED BY:
CWC, P.O. BOX 34535
SEATTLE, WA 98124-1535
1-800-774-2678 U.S.