

Gigaset

A510H

Congratulations

By purchasing a Gigaset, you have chosen a brand that is fully committed to sustainability. This product's packaging is eco-friendly!

To learn more, visit www.gigaset.com.



GIGASET. INSPIRING CONVERSATION.
MADE IN GERMANY

Gigaset A510H – your high-quality accessory

Congratulations on your purchase of this latest generation Gigaset.

Your Gigaset can do a lot more than just make calls:

Directory for 150 entries

Save phone numbers and names to the directory (→ page 26). You can designate important entries as VIPs (Very Important Persons). VIP calls are then recognised by their ringtone and their background colour (→ page 27).

If you don't (always) want it to ring

Use time control for calls (→ page 33) or ensure that all calls from a withheld number are not signalled (→ page 33).

Other practical information

Transfer the directory from an existing Gigaset handset (→ page 27), use the shortcut function (→ page 27) and adjust the background colour and contrast of the display to your requirements (→ page 32).

Environment

Gigaset Green Home – be environmentally aware when using your phone. For details of our ECO DECT products, visit www.gigaset.com/service.

For more information about your phone, visit www.gigaset.com/gigaset510h.

After purchasing your Gigaset phone, please register it at www.gigaset.com/service – this will ensure any questions you may have or warranty services you request are dealt with even faster!

Have fun using your new phone!

Overview

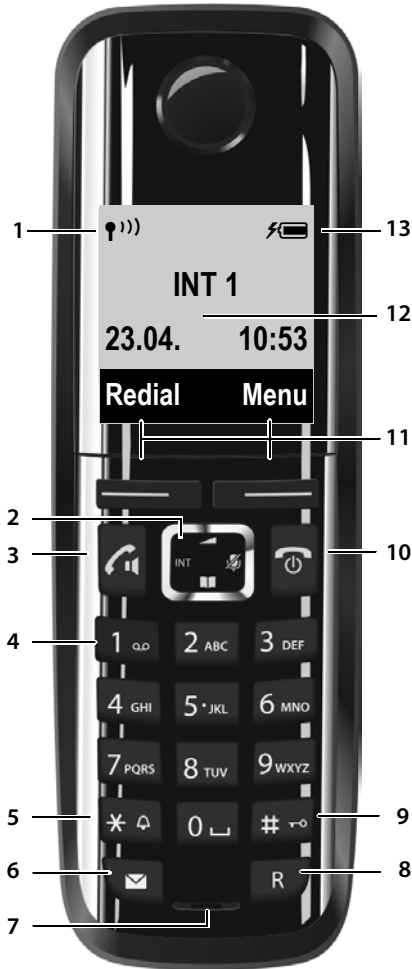

- 1 **Signal strength** (→ page 15)
Icon changes when Eco Mode+ is activated (→ page 31)
- 2 **Control key** (→ page 17)
Mute microphone (→ page 23)
- 3 **Talk/Handsfree key**
Flashing: incoming call;
Lights up: handsfree mode activated; accept call; open redial list (press briefly); start dialling (press and hold);
During a call: switch between earpiece and handsfree mode (→ page 23)
- 4 **Key 1**
Open the answering machine (dependent on base)/network mailbox (press and hold)
- 5 **Star key**
Activate/deactivate ringtones (press and hold)
- 6 **Message key** (→ page 28)
Access to calls and message lists;
Flashing: new message or new call
- 7 **Microphone**
- 8 **Recall key**
- Consultation call (flash)
- Insert a dialling pause (press and hold)
- 9 **Hash key**
Keypad lock on/off (press and hold in idle status);
Toggles between upper/lower case and digits
- 10 **End call key, On/Off key**
End call; cancel function; go back one menu level (press briefly); back to idle status (press and hold); activate/deactivate handset (press and hold in idle status)
- 11 **Display keys** (→ page 4)
- 12 **Display in idle status**
- 13 **Charge status of the batteries** (→ page 15)

Please note
To change the **display language**, proceed as described on page 12/page 32.

Display icons

The following icons are displayed depending on the settings and the operating status of your telephone:

Signal strength **📶** (→ page 15)
 or Eco Mode + icon **🔋** (→ page 31)
 Keypad locked (→ page 19)
 Ringtone switched off (→ page 34)
 Batteries are charged (→ page 15)
 Charge status of the batteries (→ page 15)

INT 1 — Name of the handset
23.04. 10:53 — Current day/current time (→ page 14)

INT 1
🕒 12:00 10:53 — Alarm clock switched on and wake up time set (→ page 31)

📧 📞
03 01 — Number of new messages:
 ♦ **📧** On the answering machine (dependent on base)/network mailbox (→ page 28)
 ♦ **📞** In the missed calls list (→ page 28)

Redial ⬅️ Menu — Display keys (→ page 4)

Display during external call:

📞 ↔ 📞 — Connection established
1234567890 — Number (or name) of caller
00:00:53 — Call duration
Menu — Display key (→ page 4)
 ♦ Set call volume (→ page 32)
 ♦ Access service information

Display keys

Other display icons:

Establishing a connection



Connection established

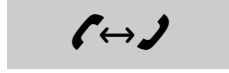

Connection cannot be established or connection interrupted



External call (→ page 23)



Internal call (→ page 24)



Alarm call (→ page 31)



Please wait...



Information



Query

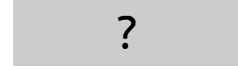

Action complete



Action failed



Display keys

The functions of the display keys change depending on the particular operating situation. Examples:

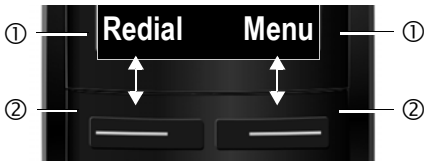





- ① Current display key function
- ② Display keys

Important display keys:

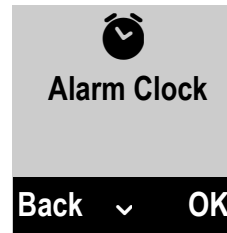
Redial	Open redial list.
Menu	Open a menu for further functions.
OK	Confirm selection.
Del.	Delete key: delete one character at a time from right to left.
Back	Go back one menu level or cancel operation.

Main menu icons



-  Alarm Clock
-  Voice Mail
-  Settings

Information on using the menus (→ page 18)
Menu overview (→ page 22)

Contents

Gigaset A510H – your high-quality accessory	1
Overview	2
Display icons	3
Display keys	4
Main menu icons	4
Safety precautions	7
First steps	8
Checking the package contents	8
Setting up the charger	9
Connecting the charger	9
Setting up the handset for use	10
Changing the display language	12
Registering the handset	13
Setting the date/time	14
What would you like to do next?	16
Using the phone	17
Control key	17
Keys on the keypad	17
Correcting incorrect entries	17
Using the menu	18
Activating/deactivating the handset	19
Activating/deactivating the keypad lock	19
Understanding the operating steps	20
Menu tree	22
Making calls	23
Making an external call	23
Ending a call	23
Accepting a call	23
Handsfree mode	23
Switching to mute	23
Making internal calls	24
Internal consultation call/connecting a call	24
Call waiting	25
Using the directory and lists	26
Directory	26
Redial list	28
Function of the message key	28
Answering machine list (dependent on base)	29
Calls list (dependent on base)	29

Using the network mailbox 30
Using fast access for the network mailbox 30
Viewing the network mailbox message 30

ECO DECT 31

Using the handset as an alarm clock 31

Setting the handset 32
Changing the display language 32
Setting the display/screensaver 32
Automatically activating/deactivating auto answer 32
Changing the handsfree/earpiece volume 32
Changing ringtones 33
Restoring the handset default settings 34

Customer service & product warranty –

Australia and New Zealand 35
Customer Service 35
Product Warranty 35
Questions and answers 37

Environment 37
Our environmental mission statement 37
Environmental management system 38
Disposal 38

Appendix 38
Care 38
Contact with liquid 38
Specifications 39
Writing and editing text 40

Accessories 41

Mounting the charger on the wall 41

Index 42

Safety precautions

Warning

Read the safety precautions and the user manual before use.

Explain their content and the potential hazards associated with using the telephone to your children.



Use only the power adapter supplied, as indicated on the underside of the base.



Use only **rechargeable batteries** that correspond to the **specification provided on page 39**, as this could otherwise result in significant health risks and personal injury.



Using your telephone may affect nearby medical equipment. Be aware of the technical conditions in your particular environment, e.g., doctor's surgery. If you use a medical device (e.g., a pacemaker), please contact the device manufacturer. They will be able to advise you regarding the susceptibility of the device to external sources of high frequency energy. Please refer to the "Appendix" chapter for the specifications of this Gigaset product.



Do not hold the rear of the handset to your ear when it is ringing or when handsfree mode is activated. Otherwise you risk serious and permanent damage to your hearing.

Your Gigaset is compatible with the majority of digital hearing aids on the market. However, perfect function with all hearing aids cannot be guaranteed.

The handset may cause interference in analogue hearing aids. If you require assistance, please contact the hearing aid supplier.



Do not install the charger in bathrooms or shower rooms. The charger is not splash-proof (→ page 38).



Do not use your phone in environments with a potential explosion hazard (e.g., paint shops).



If you give your phone to a third party, make sure you also give them the user manual.



Remove faulty bases from use or have them repaired by our Service team, as these could interfere with other wireless services.

Please note

- ◆ Not all of the functions described in this user guide are available in all countries.
- ◆ The device cannot be used in the event of a power failure. It is also **not** possible to transmit **emergency calls**.

First steps

Checking the package contents



- 1 One Gigaset A510H handset
- 2 Two batteries
- 3 One battery cover
- 4 One charger
- 5 One power adapter
- 6 One user guide

Setting up the charger

The charger is designed for use in dry rooms in a temperature range of +5°C to +45°C.

- ▶ Set up the charger on a level, non-slip surface or mount the charger on the wall (→ page 41).

Please note

Pay attention to the range of the base.

This is up to 300 m in unobstructed outdoor areas and up to 50 m inside buildings. The range is reduced when Eco Mode is activated (→ page 31).

The phone's feet do not usually leave any marks on surfaces. However, due to the multitude of different varnishes and polishes used on today's furnishings, the occurrence of marks on the surfaces cannot be completely ruled out.

Please note:

- ◆ Never expose the telephone to the effects of heat sources, direct sunlight or other electrical devices.
- ◆ Protect your Gigaset from moisture, dust, corrosive liquids and fumes.

Connecting the charger

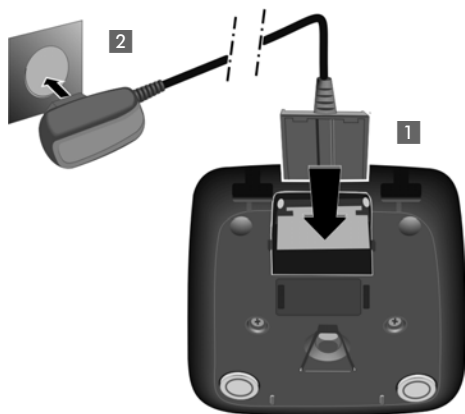

- ▶ Connect the flat plug from the power adapter **1**.
- ▶ Plug the power adapter into the plug socket **2**.

Should you wish to disconnect the plug from the charger again, press the release button **3** and disconnect the plug **4**.

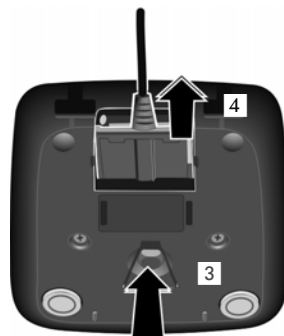

Setting up the handset for use

The display is protected by a plastic film.
Please remove the protective film!

Inserting the battery and closing the battery cover

- ▶ Insert the batteries with the polarity in the correct direction. The polarity is indicated in the battery compartment.

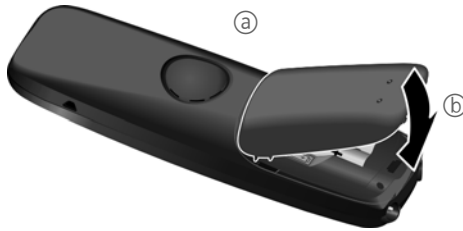

- ▶ First insert the battery cover at the top **a**.
- ▶ Then press the cover **b** until it clicks into place.

To open the battery cover, for instance to replace the batteries, insert a coin into the cavity on the casing, then pull the battery cover in an upward direction.



Initial charging and discharging of the batteries

The correct charge status can only be displayed if the batteries are first fully charged **and** discharged.

- ▶ Charge the handset in the charger for **5.5 hours**.

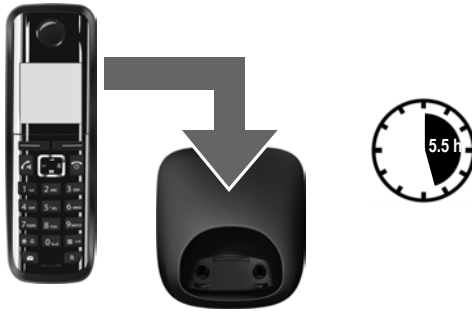

Please note

The handset may only be placed in the designated base/charger.

- ▶ After charging, remove the handset from the charger and only replace it when the batteries are **fully discharged**.

Please note

- ◆ After the first battery charge **and** discharge, you may place your handset in the charger after every call.
- ◆ Always repeat the charging and discharging procedure if you remove the batteries from the handset and reinsert them.
- ◆ The batteries may warm up during charging. This is not dangerous.
- ◆ After a while, the charge capacity of the batteries will decrease for technical reasons.

If you have any questions about using your phone, please read the tips on troubleshooting (→ page 37) or contact our Customer Care team (→ page 35).

Changing the display language

Change the display language if you do not understand the language currently set.



- ▶ Press right on the control key.

- ▶ Press the keys and **slowly** one after the other.

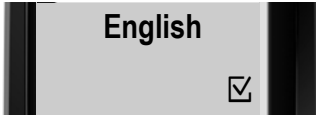

The display for setting languages appears and the current language (e.g., English) is selected



- ▶ Press down on the control key ...



... until the language you wish to use is displayed e.g., French.

- ▶ Press the key below **OK** to select this language.



The selection is marked with .

- ▶ Press and **hold** the end call key to return to idle status.

Registering the handset

Before you can use the phone, you must first register the handset to the base. The registration procedure will depend on the type of base.

Automatically registering the A510H handset to the Gigaset A510/A510A base

Prerequisite: The handset must not already be registered to a base.



- ▶ Place the handset with the **display facing up** in the base.



The handset registers automatically. Registration can take **up to 5 minutes**. **Do not remove the handset from the base during this time.**

Please note

- ◆ Each key press interrupts automatic registration.
- ◆ If the handset is already registered to a base or if automatic registration does not work, the handset will have to be registered manually.

Manually registering the A510H handset

You must manually register the handset on both the handset (1) and the base (2).

1) On the handset

Menu ▶ **Settings** ▶ **Registration** ▶ **Register Handset**



If required, enter the system PIN for the base (the default is 0000).



Press the display key.

The display shows **Handset is registering**.

2) On the base

- ▶ Within 60 seconds, press and **hold** the registration/paging key on the base (approx. 3 seconds).

First steps

Once registration is complete, the handset returns to idle status. The handset's internal number is shown in the display e.g., INT 2. If not, repeat the procedure.

Please note

For instructions on de-registering the handsets, please consult the base user guide.

Setting the date/time

Set the date and time so that the correct date and time can be assigned to incoming calls, and so that the alarm can be used.

Please note

Depending on your network provider, the date and time may be displayed automatically.

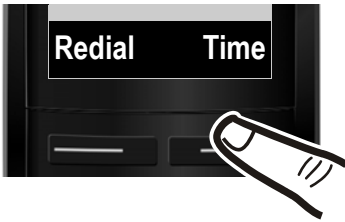

- ▶ Press the key below **Time** on the display screen to open the input field.
(If you have already set the date/time, open the input field via the menu → page 22.)

The **Date/Time** submenu is shown on the display.

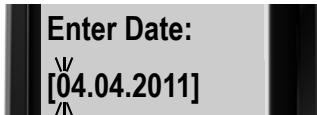

- ▶ The active input position flashes.
Enter the day, month and year as an 8-digit number via the keypad
e.g.,
for 4 April 2011.

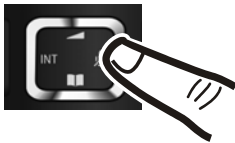

To change the input position e.g., to correct an entry, press **right** or **left** on the control key.



- ▶ Press the key below **OK** on the display screen to save your entry.



- ▶ Enter the hours and minutes in 4-digit format via the keypad e.g., [0] [7] [1] [5] for 07:15 am. Change the input position with the control key if necessary.

- ▶ Confirm with **OK**.

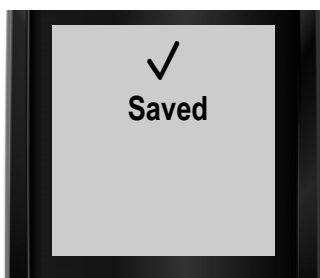

The display shows **Saved**. You will hear a confirmation tone and the handset automatically reverts to idle status, or returns to the "Settings" menu if the setting was made via the menu.

Display in idle status

Once the phone is registered and the time set, the screen display appears as follows (example).

Screen display

- ◆ Reception between the base and the handset:
 - Good to poor: 📶 📶 📶 📶
 - No reception: 📶
- ◆ Charge status of the batteries:
 - 🔋 Charged over 66%
 - 🔋 Charged between 34% and 66%
 - 🔋 Charged between 11% and 33%
 - 🔋 Charged below 11%
 - 🔋 Flashes: battery almost empty (less than 10 minutes talktime)
 - 🔋 🔋 🔋 🔋 Illuminated: batteries charging
- ◆ INT 1
Internal name of the handset

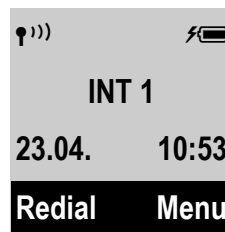





If **Eco Mode+** (→ page 31) is activated, the 📶 icon is displayed in the top left corner of the display.

Your phone is now ready for use.

What would you like to do next?

Now that you have successfully set up your Gigaset, you can immediately start calling – or you can adapt it to your personal requirements. Use the following guide to quickly locate the most important functions.

Information on is located here.
Using the phone	 page 17
Setting ringtones	 page 33
Transferring directory entries from existing Gigaset handsets to new handset(s)	 page 27
Setting Eco Mode / Eco Mode+	 page 31
Setting the earpiece volume	 page 32

Using the phone





Control key

In the description below, the side of the control key (up, down, right, left) that you have to press in the different operating situations is marked in black e.g.,  for "press the right edge of the control key".



The control key has a number of different functions:







When the handset is in idle status

-  Open the main menu.
-  Open the directory.
-  Open the list of handsets.
-  Call up the menu for setting the handset's call volume (→ page 32).





In menus and lists

- / Scroll up/down line by line.





In input fields

You can use the control key to move the cursor up , down , right  or left .

During an external call

-  Mute the microphone.
-  Open the directory.
-  Initiate an internal consultation call.
-  Adjust the loudspeaker volume for earpiece and handsfree mode.

Keys on the keypad

- // etc.
Press the corresponding key on the handset.
-  Enter digits or letters.

Correcting incorrect entries

You can correct incorrect characters in the input fields by navigating to the incorrect entry using the control key. You can then:

- ◆ Use the display key **Del.** to delete the character to the left of the cursor
- ◆ Insert characters at the cursor position
- ◆ Overwrite the highlighted (flashing) character e.g., when entering time and date.

Using the menu

Your telephone's functions are accessed via a menu consisting of several levels (menu overview → page 22).



Main menu (first menu level)

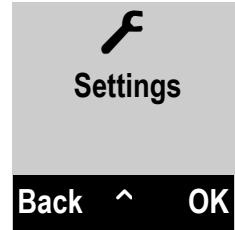

- ▶ With the handset in idle status, press the display key **Menu** or right on the control key  to open the main menu.

The functions in the main menu are displayed in the form of a list with names and icons (example on the right).



Selecting a function

- ▶ You can scroll between functions using the control key . The selectable function is shown in the display.
- ▶ Press the display key **OK** or right on the control key  to select the displayed function. This opens the corresponding submenu and the first entry is displayed.

If you press the display key **Back**, left on the control key  or **briefly** press the end call key , the display returns to idle status.

Submenus

The functions in the submenu are displayed with the corresponding names.

Selecting a function

- ▶ You can scroll between functions using the control key . The relevant function is shown in the display.
- ▶ Press the display key **OK** to select the displayed function. This opens the corresponding submenu and the first entry is displayed.

If you press the display key **Back** or **briefly** press the end call key , you return to the previous menu level or cancel the operation.

Any settings you have not confirmed by pressing **OK** will be discarded.

Reverting to idle status

From any point in the menu:

- ▶ Press and **hold** the end call key  or
- ▶ Do not press any key: after 2 minutes, the display will **automatically** revert to idle status.

An example of the display in idle status is shown on page 15.

Activating/deactivating the handset



In idle status, press and **hold** the end call key (confirmation tone).

Activating/deactivating the keypad lock

The keypad lock prevents any inadvertent use of the phone.



In idle status, press and **hold** the hash key (confirmation tone). The keypad lock is activated or deactivated. When the keypad lock is activated, the  icon appears in the display.

If the keypad lock is activated, a corresponding message is displayed when you press a key.

The keypad lock deactivates automatically when you receive a call. It is reactivated when the call is finished.

Please note

When the keypad lock is active, you cannot call emergency numbers.

Understanding the operating steps

The operating steps are shown in abbreviated form, for example:

Menu ▶ **Settings** ▶ **Eco Mode+** (☑ = on)

▶ This means you should proceed as follows:

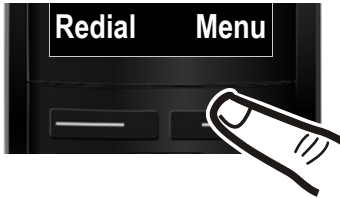

▶ Press the key below **Menu** on the display screen to open the main menu.



▶ Press down on the control key  ...



... until the **Settings** menu item appears.

▶ Press the key below **OK** on the display screen to confirm your selection.



▶ Press down on the control key  ...



... until the **Eco Mode+** menu item appears.

- ▶ Press the key below **OK** on the display screen to switch the function on or off (✓ = on).

- ▶ Press the key below **Back** on the display screen to jump back to the previous menu level.

Or

Press and **hold** the end call key (📞) to return to idle status.

Menu tree

The menu entries are divided into sections. The page numbers refer to the relevant description in the user guide.

To open the main menu: press the **Menu** display key when the phone is in idle mode.

Alarm Clock

Activation	→ page 31
Wake up time	→ page 31

Voice Mail (Menu dependent on base)

Settings

Date/Time	→ page 14	
Audio Settings	Call Volume	→ page 32
	Ringer Volume	→ page 33
	Advisory Tones	→ page 34
	Battery Low	→ page 34
	Ringtones (Handset)	→ page 33
	Ringtones (Base)	(dependent on base)
Display	Screensaver	→ page 32
	Colour Schemes	→ page 32
	Contrast	→ page 32
Language	→ page 32	
Registration	Register Handset	→ page 13
	De-register Handset	(dependent on base)
Telephony	Auto Answer	→ page 32 (further submenus dependent on base)
System	Reset Handset	→ page 34 (further submenus dependent on base)
Eco Mode	→ page 31	
Eco Mode+	→ page 31	



Making calls

Making an external call

External calls are calls using the public telephone network.

 Enter the number and press the talk key.

Or:

  Press and **hold** the talk key  and then enter the number.

You can cancel the dialling process with the end call key .

You are shown the duration of the call while the call is in progress.

Please note

Dialling with the directory (→ page 26), calls list (→ page 29) and redial list (→ page 28) saves you from repeatedly keying in phone numbers.

Ending a call

 Press the end call key.

Accepting a call

The handset indicates an incoming call in three ways: by ringing, by a display on the screen and by the flashing talk key .

To accept the call, press the talk key .

If the handset is in the charger and the **Auto Answer** function is activated (→ page 32), the handset automatically answers calls when you remove it from the base/charger.

If the ringer is intrusive, you can deactivate it:

Menu ▶ **Silent** ▶ **OK**

You can accept the call as long as it is displayed on the screen.

Handsfree mode

In handsfree mode, you activate the loud-speaker so that you can hear the caller without having to hold the handset to your ear. You therefore have both hands free and other people can listen in on the conversation.

Please note

Inform your caller before you use the handsfree function so that the caller knows a third party may be listening.

Activating/deactivating handsfree mode

During a call, activate or deactivate handsfree mode:

 Press the handsfree key. Each key press switches between earpiece and handsfree mode. If handsfree mode is activated, the key is lit up.

If you wish to place the handset in the charger during a call:

- ▶ Press and hold the handsfree key  while placing the handset in the base/charger and for a further 2 seconds.

For instructions on adjusting the handsfree volume, see page 32.

Switching to mute



You can deactivate your handset's microphone during a call.

 Press **right** on the control key to mute the handset. The display shows **Microphone is switched off**. Press the key again to unmute the microphone.



Making internal calls

Internal calls are free calls between handsets that are registered with the same base.

Calling a specific handset

-  Initiate internal call.
-  Enter the number of the handset.



Or:

-  Initiate internal call.
-  Select handset.
-  Press the talk key.

Calling all handsets ("group call")

-  Press and hold.

Or:

-  Initiate internal call.
-  Press the star key.

Or:

-  Initiate internal call.

Call All Select

-  Press the talk key.



All handsets are called.

Ending a call

-  Press the end call key.

Internal consultation call/ connecting a call

You are in conversation with an **external** participant. Press the control key  and call one or all handsets. The external participant hears the music on hold.

- ◆ **Before** the internal participant has answered, press the end call key ; the call is diverted to the participant who answers the call.
- ◆ **After** the internal participant has answered you can talk to him. Then press the end call key ; the call is diverted, or press the  display key; you are reconnected to the external participant.

Please note: This equipment may not provide for the effective handover of a call to another device connected to the same line.

Call waiting

Many Telecommunication providers in Australia and New Zealand offer a Call waiting service on your Home Phone Line. Please speak to your service provider to check if your Home Phone line is activated for this service (charges may apply).

The most common providers instructions for Call waiting are as follows.

Please note

These processes depend on the network provider and are subject to change.

Australia:

Telstra:

To answer an incoming call when you're already on a call, or to switch between calls:

- ▶ Press the Recall key **[0..]** and listen for the dial tone, then press **[2 AND]**.

To hang up on one call and return to the other:

- ▶ Press the Recall key **[0..]** on your phone and listen for the dial tone, then press **[1 AND]**.

To reject an incoming call when you are already on a call:

- ▶ Push the Recall key **[0..]** on your phone and listen for the dial tone, then press **[0..]** again.

For more information please contact Telstra.

Optus:

You are on the phone and hear the beeps.

To put the first caller on hold and talk to the new caller (the caller on hold will hear nothing):

- ▶ Press the Recall key **[0..]** on your phone.

To return to the first caller:

- ▶ Press the Recall key **[0..]** and put the new caller on hold. You can alternate between the calls in this way.

Or

- ▶ Hang up the first call. The phone will ring again with the second caller. This means that you will not be able to go back to the first caller.

For more information please contact Optus.

New Zealand:

Telecom NZ:

You are on the phone and hear four beeps.

To talk to the second caller:

- ▶ Press the Recall key **[0..]** on your phone.

To return to the first caller:

Press the Recall key **[0..]** again and you will be able to continue your original conversation.

For more information please contact Telecom NZ.

Using the directory and lists

The options are:

- ◆ Directory
- ◆ Redial list
- ◆ Calls lists
- ◆ Answering machine list (dependent on base)/network mailbox list

You can create a personalised directory for your own individual handset. You can also send lists/entries to other handsets (→ page 27).

Directory

You can save a total of 150 entries in the directory.

Please note

To quickly access a number from the directory (shortcut), you can assign the number to a key (→ Using shortcut keys, page 27).

In the **directory**, you can save

- ◆ Numbers and corresponding names
- ◆ VIP ringtones and colours.

You open the directory in idle status using the  key.

Length of the entries

Number: max. 32 digits
Name: max. 16 characters

Saving the first number in the directory

 ▶ Dir. empty New Entry?



Enter the number and press **OK**.



Enter the name and press **OK**.

Storing a number in the directory

 ▶ **Menu** ▶ New Entry



Enter the number and press **OK**.



Enter the name and press **OK**.

Order of directory entries

Directory entries are generally sorted alphabetically by surname. Spaces and digits take first priority.

The sort order is as follows:



1. Space
2. Digits (0–9)
3. Letters (alphabetical)
4. Other characters

To work round the alphabetical order of entries, insert a space or a digit before the first letter of the name. These entries will then move to the beginning of the directory.

Selecting directory entries

 Open the directory.

You have the following options:

- ◆ Use  to scroll through the entries until the required name is selected.
- ◆ Enter the first character of the name, if necessary scroll to the entry with the  key.

Dialling with the directory

 ▶  (Select entry)



Press the talk key.

Managing directory entries

 ▶  (Select entry)

Menu Press the display key.

The following functions can be selected with :

VIP Caller Melody

Mark a directory entry as a VIP (Very Important Person) by assigning a specific ringtone to it. The entry is flagged with the  icon in the directory. You recognise VIP calls by the ringtone.

VIP Caller Colour

Mark a directory entry as a VIP (Very Important Person) by assigning a specific background colour to it. The entry is displayed with this background colour in the address book and marked with the  icon. VIP calls are then recognised by their background colour.

Edit Entry

Edit the number if required and press **OK**.

Edit the name if required and press **OK**.

Use Number

Edit or add to a saved number and then use  to dial the number or save the number as a new entry;

To do so, display the number and press:

Menu ▶ **Copy to Directory** ▶ **OK**

Delete Entry

Delete selected entry.

Send Entry

Send a single entry to a handset
(→ Transferring the directory to another handset, page 27).

Delete List

Delete **all** directory entries.

Send List



Send the entire directory to a handset
(→ Transferring the directory to another handset, page 27).



Shortcut

Assign the current entry to a shortcut key
(→ next section "Using shortcut keys").

Using shortcut keys

You can assign directory entries to the keys

 and  - :

 ▶  (select entry) ▶ **Menu** ▶ **Shortcut**
▶  (press the key you want to assign the number to)

In idle status, press and **hold** the required shortcut key to **dial**.

Transferring the directory to another handset

You can transfer directory entries from other handsets to your new handset — even entries from old handsets.

Prerequisites:

- ◆ The sending and receiving handsets must both be registered to the same base.
- ◆ The other handset and the base can send and receive directory entries.

 ▶  (Select entry) ▶ **Menu** (Open menu)
▶ **Send Entry / Send List**

 Select the internal number of the receiving handset and press **OK**.

You can transfer several individual entries one after the other by responding to the **Entry copied. Next entry?** prompt with **OK**.

A message appears on the display to confirm a successful transfer. You will hear the confirmation tone.

Please note:

- ◆ Entries with identical numbers are not overwritten on the receiving handset.
- ◆ The transfer is cancelled if the phone rings or if the memory of the receiving handset is full.
- ◆ VIP melodies and colours assigned to entries are not transferred.

Adding a displayed number to the directory

You can copy numbers displayed in a list, e.g., the calls list or redial list, to the directory.



A number is displayed:

Menu ▶ Copy to Directory

- ▶ Complete the entry (→ Storing a number in the directory, page 26).

Copying a number from the directory



In some operating situations, you can open the directory to copy a number (e.g., during an external call or in pre-dialling mode). Your handset need not be in idle status.

-  Open the directory.
-  Select an entry and press **OK**.



Redial list

The redial list contains the ten numbers last dialled with the handset (max. 32 numbers). If one of the numbers is in the directory, the corresponding name will be displayed.

Manual redial

-  Press the talk key **briefly**
Or
- Redial** Press the display key.
-  Select entry.
-  Press the talk key. The number is dialled.

Managing entries in the redial list

-  Press the talk key **briefly**
Or
- Redial** Press the display key.
-  Select entry.
- Menu** Open menu.

The following functions can be selected with :

Use Number

(As in the directory, → page 27)

Copy to Directory (→ Storing a number in the directory, page 26)

Delete Entry

Delete selected entry.

Delete List

Delete **all** entries in the redial list.

Function of the message key



Opening lists

Use the message key  to open the following lists:

- ◆ Answering machine list (dependent on base) or network mailbox, if your network provider supports this function and fast access is set for the network mailbox (→ page 30).
- ◆ Calls list

An advisory tone sounds as soon as a **new entry** arrives in a list.

Depending on the type of the new entry, an icon appears in the display while in **idle status**:

- Icon** **New message ...**
-  ... in the answering machine list (dependent on base) or on the network mailbox
-  ... in the **missed calls** list

The number of **new** entries is displayed under the corresponding icon.



Please note

If calls are saved on the network mailbox, you will receive a message if the list type has been set accordingly (see your network provider user guide).

After pressing the message key , you can see all lists containing messages and the network mailbox list.

The list is displayed with the number of new entries (1) and the number of old, read entries (2) (example):

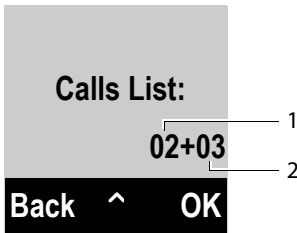

Select a list with . To open, press **OK**.

Activating/deactivating flashing message key (dependent on base)

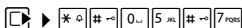

You can specify whether you want the message key  to flash for new messages (default setting). Proceed as follows:

- ▶ Press the following keys in sequence:





You will see:

97

- ▶ Press one of the following keys to select the type of message:
 -  For missed calls
 - Or  For messages on the answering machine (dependent on base)/network mailbox

Your selection is displayed (e.g., 5 for missed calls), the current setting flashes:

975 SET: [0]

- ▶ Press  or  to determine the setting for new messages:

 The message key flashes (it goes off when the key is pressed)

Or  The message key does not flash

Your selection is displayed (e.g., 1):

975 SET: [1]

- ▶ Press the display key **OK**.

Answering machine list (dependent on base)

You can use the **answering machine list** to listen to the messages that are on the answering machine.

Calls list (dependent on base)

Prerequisite: Calling Line Identification Presentation (CLIP)

Depending on the base, the calls list contains:

- ◆ All calls
 - Accepted calls
 - Unanswered calls
 - Calls recorded by the answering machine
- ◆ Or missed calls only
 - Unanswered calls
 - Calls not recorded by the answering machine

In idle status, you can open the calls list by pressing the message key .

To return a call, select the corresponding entry and press the talk key .

See your base user guide for further information.

Using the network mailbox

The network mailbox is your provider's voice mail feature within the network. More information is available from your provider.

You cannot use the network mailbox unless you have **requested** it from your provider.

The following information is only applicable when using your handset with a Gigaset A510 base. If you have registered your handset to a different base, such as the Gigaset A510A, please refer to your base user guide.

Using fast access for the network mailbox

To access the network mailbox, simply **press and hold** the  key – you do not have to select it via the menu.

You only need to enter the number of the network mailbox.

Menu ▶ **Voice Mail**

▶ **Network Mailbox** = selected)



Enter the network mailbox number and press **OK**.

The setting for fast access applies to all handsets.

Calling the network mailbox



Press and hold. You are connected straight to the network mailbox.

Please note

You can also connect to the network mailbox via the menu:

Menu ▶ **Voice Mail** ▶ **Play Messages**

Viewing the network mailbox message

When a message is recorded, you receive a call from the network mailbox. If you have requested Calling Line Identification, the network mailbox number is displayed. If you accept the call, the new messages are played back. If you do not accept the call, the network mailbox number is saved in the missed calls list and the message key flashes (→ page 28).

Please note

Enter the network mailbox phone number into your directory along with the designation "Network mailbox"; the display and the calls list will then show this designation.

ECO DECT

You are helping to protect the environment with your Gigaset.

Reducing energy consumption

Your telephone has a power-saving adapter plug and uses less power.

Reducing radiation (dependent on base)

The radiation can only be reduced if your base supports this function.

The telephone's transmission power is **automatically** reduced depending on the distance to the base.

You can reduce the radiation from the handset and base even more by using **Eco Mode** or **Eco Mode+**. For further information, please refer to your base user guide.

Using the handset as an alarm clock

Prerequisite: The date and time have already been set (→ page 14).

Activating/deactivating the alarm clock

Menu ▶ Alarm Clock ▶ Activation (☑ = on)

After you activate the alarm clock, the menu for setting the wake up time opens automatically.

The  icon and wake up time are shown on the display.

A wake up call is signalled on the display (→ page 3), with the selected ringer volume and melody (→ page 33). The wake up call sounds for 60 seconds. If no key is pressed, the wake up call is repeated twice at five minute intervals and then switched off.

During a call, the wake up call is only signalled by a short tone.

Setting the wake up time

Menu ▶ Alarm Clock ▶ Wake up time



Enter the wake up time in hours and minutes, then press **OK**.

Deactivating the wake up call/ repeating after a pause (snooze mode)

Prerequisite: A wake up call is sounding.

Off Press the display key. The wake up call is deactivated.

Or

Snooze Press the display key or any key. The wake up call is deactivated and then repeated after 5 minutes. After the second repetition the wake up call is deactivated completely.

Setting the handset

Your handset comes with default settings, but you can change the settings to suit your individual requirements.

Changing the display language



You can view the display texts in different languages.

Menu ▶ **Settings** ▶ **Language**

The current language is indicated by .

 Select a language and press **OK**.

If you accidentally choose a language you do not understand:

 ▶  6  4 

 Select the correct language and press **OK**.

Setting the display/ screensaver

You have a choice of four colour schemes and several different contrasts. You can also configure a screensaver.

Menu ▶ **Settings** ▶ **Display**

You have the following options:

Screensaver

In idle status a digital clock can be displayed as a screensaver. This replaces the idle status display. You can choose between **No Screensaver** and **Digital Clock**.

The screensaver is not displayed in certain situations e.g., during a call or if the handset is de-registered.

To show the display in idle status, briefly press the end call key .

Colour Schemes

You can view the display backlight in different colours. Four colour schemes are available.

Contrast

Nine contrast settings are available.

Automatically activating/ deactivating auto answer

If this function is activated, you can simply lift the handset out of the charger without having to press the talk key  when you receive a call.

Menu ▶ **Settings** ▶ **Telephony**
▶ **Auto Answer**

OK Press the display key ( = on).

Changing the handsfree/ earpiece volume



You can set the volume for handsfree mode and earpiece mode to five different levels.

In idle status:

 ▶ **Call Volume**



Earpiece Volume / Handsfree Volume

Select and press **OK**.

 Set the volume (e.g., volume 3 = .

OK Press the display key to save the setting.

During a conversation via the earpiece or in handsfree mode:



 Press the control key to open the menu for setting the volume. Set the earpiece or handsfree volume by pressing .

The setting will automatically be saved after approximately 3 seconds or press the display key **OK**.

Please note

You can also set the call volume using the menu (→ page 22).

Changing ringtones

- ◆ **Volume:**
You can choose between five volumes (e.g., volume 3 = ) and the "crescendo" ring (volume increases with each ring, volume 6 = .
- ◆ **Ringtones:**
You can select from a list of pre-loaded ringtones and melodies.

You can set different ringtones for the following functions:

- ◆ Internal calls
- ◆ External calls
- ◆ Alarm clock

Setting the ringer volume

The ringer volume is the same for all types of ring.

In idle status:

 ▶ **Ringer Volume**

 Set the volume.

OK Press the display key to save the setting.

Please note

You can also adjust the ringer volume via the menu (→ page 22).

Setting ringtones

Set different ringtones for external calls, internal calls and the alarm clock.

For internal calls and the alarm clock

In idle status:

 ▶ **Ringtones (Handset)**

Internal Calls / Alarm Clock

Select and press **OK**.

 Select melody and press **OK**
(= selected).

For external calls:

In idle status:

 ▶ **Ringtones (Handset)**

External Calls

Select and press **OK**.

 can be used to select the following:

Melodies

You can set the ringtone as described above.

Time Control

You can specify a time period when you do not want the telephone to signal external calls e.g., during the night.

Activation is switched on or off by pressing **OK** (= activated).

Settings

Ringer off from: /Ringer off until:

Enter time in 4-digit format.

Please note

During this period, you will continue to receive calls from numbers to which you have assigned a personalised melody/background colour in the directory (VIP).

Anonymous Calls Silent

You can set your handset so that it doesn't ring for calls where Calling Line Identification has been withheld. The call will only be signalled on the display.

Switch the **Anonymous Calls Silent** function on or off by pressing **OK**
(= activated).

Please note

You can also set the ringtones via the menu (→ page 22).

Setting the handset

Activating/deactivating the ringer

You can:

- ◆ Permanently deactivate the ringer in idle status or when receiving a call
- ◆ Deactivate the ringer for the current call only.

The ringer cannot be re-activated while a call is in progress.

Deactivating the ringer permanently

 Press and **hold** the star key.

The  icon appears in the display.

Reactivating the ringer

 Press and **hold** the star key.

Deactivating the ringer for the current call



Menu ▶ **Silent** ▶ **OK**

Activating/deactivating advisory tones/battery warning tones

Your handset uses advisory tones to tell you about different activities and statuses. These can be activated and deactivated independently of each other:

- ◆ **Advisory Tones**
 - **Confirmation tone:** at the end of an entry/setting and when a new entry arrives in the calls list
 - **Error tone:** when you make an incorrect entry
 - **Key click:** every key press is confirmed.
- ◆ **Battery Low**

The battery requires charging.

 ▶ **Advisory Tones / Battery Low**
Select and press **OK** to activate or deactivate ( = activated).

The **menu end tone** when scrolling at the end of a menu cannot be deactivated.

Restoring the handset default settings

You can reset any individual settings and changes that you have made.

The following settings are **not** affected by a reset:

- ◆ Registering the handset to the base
- ◆ Date/time
- ◆ Entries in the directory, calls lists

Menu ▶ **Settings** ▶ **System** ▶ **Reset Handset**

OK Confirm prompt.

Customer service & product warranty – Australia and New Zealand

IMPORTANT

Please retain your sales receipt as proof of the date of purchase.

Customer Service

If you require assistance in operating this product please contact us

AUS: 1300 780 878 or by e-mail at the Customer Care section of our website at www.gigaset.com/au

NZ: 0800 780 878 or by e-mail at the Customer Care section of our website at www.gigaset.com/au

If you are trying to access a Network Service and require assistance specifically related to the network service or would like to subscribe to the service, contact your service provider.

Product Warranty

Our goods come with guarantees that cannot be excluded under the Australian Consumer Law. You are entitled to a replacement or refund for a major failure and for compensation for any other reasonably foreseeable loss or damage. You are also entitled to have the goods repaired or replaced if the goods fail to be of acceptable quality and the failure does not amount to a major failure.

Subject to the conditions stated in this Product Warranty Section, this product, excluding battery and accessory devices, is guaranteed against any defect in materials or workmanship under conditions of normal use for a period of 24 months from date of purchase (Product Warranty).

The benefits conferred by this warranty are in addition to other warranties and remedies that are implied under the Australian Trade Practices Act and similar Country, State and Territory laws (Statutory Rights). For New Zealand customers, this warranty is in addition to statutory rights observed under New Zealand Legislation.

Subject to your Statutory Rights, the goods will not be eligible for service under this warranty if:

1. Proof of purchase cannot be provided;
2. The defect was caused by an accident, misuse, abuse, improper installation or operation, vermin infestation, lack of reasonable care, unauthorised modification, loss of parts, tampering or attempted repair by a person not authorised by Gigaset; or
3. The product has been damaged by lightning or a mains power surge.
4. The Phone was not imported into Australia by Gigaset Communications GmbH.

To obtain service during the terms of this warranty and/or to claim warranty call the Information Line on

AUS: 1300 780 878 or by e-mail at the Customer Care section of our website at www.gigaset.com/au

NZ: 0800 780 878

Customer service & product warranty – Australia and New Zealand

If it is necessary to have the product serviced, the customer service representative will inform you of the product return process. If it is necessary to have the product serviced under warranty in both Australia and New Zealand you will need to return the product to your place of purchase. If this is not possible please call the relevant Technical Support line listed in this document whereby the customer service representative will inform you of the product return process. Except as explicitly stated in this document, all other expenses with regard to claiming Product Warranty shall be borne by you.

Please ensure that:

1. You provide proof of purchase;
2. Your product is suitably packaged; and
3. You have included all components from the original purchase.

In Australia and New Zealand the product will be serviced within ten business days after the defective product is received by the authorised agent.

Any and all warranty services referred to under this Product Warranty will be provided

- ▶ In **Australia** by CommsPlus Distribution, Unit 3a, 100 Station Street, Nunawading, Victoria, 3131 Phone: **1300 780 878**, and
- ▶ in **New Zealand** by Atlas Gentech (NZ) Limited, 76 Carbine Road, Mt Wellington, Auckland 1741 Phone: **0800 780 878**.

Subject to your Statutory Rights:

1. Any claim under this warranty is limited to the cost of repair or replacement of the product; and
2. If the goods are found to be in sound working order by the authorised service centre, you may be charged a fee for service and for any other direct costs associated with having the product delivered for service.

Replacement or repair services are only offered for products purchased in Australia and New Zealand that bear Gigaset Communications GmbH local registered N Number and Telepermit markings.



Please have your proof of purchase ready when calling.

IMPORTANT NOTICE

Under power failure conditions, this telephone may not operate. Please ensure that a separate telephone, not dependent upon local power, is available for emergency use.

Questions and answers

If you have any queries about the use of your telephone, visit our website at www.gigaset.com/service for assistance 24/7.

The table below also lists steps for troubleshooting.

The display is blank.

1. The handset is not activated.
 - › Press and **hold** the end call key .
2. The battery is empty.
 - › Charge the battery or replace it (→ page 10).

"Base" flashes on the display.

1. The handset is outside the range of the base.
 - › Move the handset closer to the base.
2. The base's range is reduced because Eco Mode is activated.
 - › Deactivate Eco Mode (→ page 31) or reduce the distance between the handset and the base.
3. The base is not activated.
 - › Check the base power adapter.
4. Handset has not been registered with the base or has been de-registered.
 - › Register the handset (→ page 13).

The handset does not ring.

1. The ringtone is switched off.
 - › Activate the ringtone (→ page 34).
2. The phone only rings if the phone number has been transferred.
 - › Activate the ringtone for anonymous calls (→ page 33).

The connection always terminates after approx. 30 seconds.

Repeater activated/deactivated.

- › Activate/deactivate the handset (→ page 19).

The other party cannot hear you.

You pressed the mute key  during a call. The handset is "muted".

- › Unmute the microphone (→ page 23).

The number of the caller is not displayed although CLIP has been set.

Calling Line Identification is not enabled.

- › **The caller** should ask the network provider to enable Calling Line Identification (CLI).

You hear an error tone when keying an input.

Action has failed/invalid input.

- › Repeat the process.
 - › Watch the display and refer to the user manual if necessary.

Exclusion of liability

Some displays may contain pixels (picture elements), which remain activated or deactivated. This is completely normal and does not indicate a fault.

Environment

Our environmental mission statement

We, Gigaset Communications GmbH, bear social responsibility and are actively committed to a better world. Our ideas, technologies and actions serve people, society and the environment. The aim of our global activity is to secure sustainable life resources for humanity. We are committed to a responsibility for our products that comprises their entire life cycle. The environmental impact of products, including their manufacture, procurement, distribution, utilisation, service and disposal, are already evaluated during product and process design.

Further information on environmentally friendly products and processes is available on the Internet at www.gigaset.com.

Environmental management system



Gigaset Communications GmbH is certified pursuant to the international standards ISO 14001 and ISO 9001.

ISO 14001 (Environment): Certified since September 2007 by TÜV SÜD Management Service GmbH.

ISO 9001 (Quality): Certified since 17/02/1994 by TÜV SÜD Management Service GmbH.

Disposal

Batteries should not be disposed of in general household waste. Observe the local waste disposal regulations, details of which can be obtained from your local authority or the dealer you purchased the product from.

All electrical and electronic equipment must be disposed of separately from general household waste using the sites designated by local authorities.



The appropriate disposal and separate collection of used equipment serve to prevent potential harm to the environment and to health. They are a precondition for the re-use and recycling of used electrical and electronic equipment.

For further information on disposing of your used equipment, please contact your local authority or your refuse collection service.

Appendix

Care

Wipe the base station, charging cradle and handset with a **damp** cloth (do not use solvent) or an antistatic cloth.

Never use a dry cloth. This can cause static.

Impairments in high-gloss finishes can be carefully removed using display polishes for mobile phones.

Contact with liquid

If the handset has come into contact with liquid:

1. **Switch off the handset and remove the battery pack immediately.**
2. Allow the liquid to drain from the handset.
3. Pat all parts dry, then place the handset with the battery compartment open and the keypad facing down in a dry, warm place **for at least 72 hours** (not in a microwave, oven etc.).
4. **Do not switch on the handset again until it is completely dry.**

When it has fully dried out, you will normally be able to use it again.

Specifications

Batteries

Technology: Nickel-metal-hydride (NiMH)

Size: AAA (Micro, HR03)

Voltage: 1.2 V

Capacity: 550 - 1000 mAh

The device is supplied with two approved batteries.

Handset operating times/charging times

This Gigaset can charge batteries up to a capacity of 1000 mAh. Using special high-performance batteries or batteries with high capacities is not recommended for cordless phones.

The operating time of your Gigaset depends on the capacity and age of the batteries and the way it is used. (Standby times/talktimes/operating times are maximum possible times, charging times are typical values).

	Capacity (mAh) approx.			
	550	700	800	1000
Standby time (hours)	220	255	290	360
Talktime (hours)	20	23	27	33
Operating time for 1.5 h of calls per day (hours)				
- Without Eco Mode+	135	155	180	255
- With Eco Mode+	95	110	130	155
Charging time in base (hours)	6	7	8	10
Charging time in charger (hours)	5.5	6.5	7	9

Due to the constant progression in battery development, the list of recommended batteries in the FAQ section of the Gigaset Customer Care pages is updated regularly:





www.gigaset.com/service

General specifications

DECT standard	Supported
GAP standard	Supported
No. of channels	60 duplex channels
Radio frequency range	1880–1900 MHz
Duplex method	Time multiplex, 10 ms frame length
Repeat frequency of the transmission pulse	100 Hz
Length of the transmission pulse	370 µs
Channel grid	1728 kHz
Bit rate	1152 kbit/s
Modulation	GFSK
Language code	32 kbit/s
Transmission power	10 mW average power per channel, 250 mW pulse power
Range	Up to 300 m outdoors, up to 50 m indoors
Environmental conditions for operation	+5°C to +45°C, 20% to 75% relative humidity
Dialling mode	DTMF (tone dialling)

Writing and editing text

The following rules apply when writing text:

- ◆ Multiple letters and characters are assigned to each key between **0..** and **9 numz** as well as *** ␣** and **# →**.
- ◆ Control the cursor with    .
- ◆ Characters are inserted at the cursor position.
- ◆ Press the display key **Del.** to delete the **character** to the left of the cursor.
- ◆ The first letter of the name of directory entries is automatically capitalised, followed by lower case letters.

Setting upper/lower case or digits

Repeatedly press the hash key **# →** to change the text input mode.

123	Digits
Abc	Upper case *
abc	Lower case

* First letter in capitals, all others in lower case

When the mode is changed, the active mode is indicated at the bottom left of the screen.



Writing names

- ▶ Enter the individual letters/characters by pressing the corresponding key.

The characters assigned to the key are shown in a selection line at the bottom left of the screen. The selected character is highlighted.

- ▶ **Briefly** press the key several times in succession to select the required letter/character.

Standard characters

	1x	2x	3x	4x	5x	6x	7x	8x	9x	10x	11x	12x	13x	14x	15x	16x
1 	1	€	£	\$	¥	¤										
2 abc	a	b	c	2	ä	á	à	â	ã	ç						
3 def	d	e	f	3	ë	é	è	ê								
4 ghi	g	h	i	4	ï	í	ì	î								
5 jkl	j	k	l	5												
6 mno	m	n	o	6	ö	ñ	ó	ò	ô	õ						
7 pqrs	p	q	r	s	7	ß										
8 tuvw	t	u	v	w	8	ü	ú	ù	û							
9 wxyz	w	x	y	z	9	ÿ	ý	æ	ø	å						
0 .. ¹⁾		.	?	!		0	+	-	:	;	"	'	;	_		
* ␣	*	/	()	<	=	>	%								
# →		#	@	\	&	§										

- 1) Space
- 2) Line break

Accessories

Compatibility

You can find more information about the handset functions in connection with the individual Gigaset bases at:

www.gigaset.com/compatibility

Ordering Gigaset products

All accessories and batteries are available from your phone retailer.



Use only original accessories. This will avoid possible health risks and personal injury, and also ensure that all the relevant regulations are complied with.

Mounting the charger on the wall

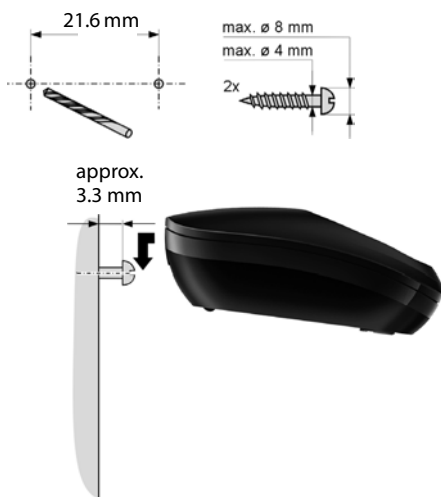

Index

A

Accepting a call	23
Accessories	41
Acknowledge tones	34
Activating	
auto answer	32
flashing message key.....	29
handset	19
keypad lock	19
Alarm clock.....	31
Answering machine list	
(dependent on base)	29
Auto answer	32
Automatic	
auto answer	23, 32

B

Battery	
charging	2, 3
display	2, 3
icon.....	2, 3
inserting	10
tone	34

C

Call	
ending	23
external	23
internal	24
transferring (connecting)	24
Call duration.....	23
Call waiting, internal call.....	25
Calling	
externally	23
internally.....	24
Care of the telephone	38
Changing	
display language.....	12, 32
earpiece volume	32
handsfree volume.....	32
ringtone.....	33
Character set	40
Charge status indicator	2, 3
Colour scheme.....	32
Confirmation tone.....	34
Connecting.....	24

Consultation call (internal)	24
Contrast	32
Control key	2, 17
Correcting incorrect entries	17
Customer service & product warranty –	
Australia and New Zealand	35

D

Deactivating	
auto answer	32
flashing message key.....	29
handset	19
keypad lock	19
Delete key.....	4
Deleting characters	17
Dialling	
using shortcut	27
with directory	26
Digital clock	32
Directory	26
copying number from text.....	28
managing entries	27
opening.....	17
order of entries	26
saving entry	26
saving first number	26
sending entry/list to handset.....	27
using to enter numbers.....	28
Display	
changing display language	12, 32
colour scheme.....	32
contrast	32
in idle status.....	15, 18
network mailbox message	30
screensaver.....	32
setting	32
Display keys	2, 4
Disposal.....	38

E

Earpiece volume	32
ECO DECT	31
End call key.....	2, 23
Ending a call.....	23
Entry	
saving (network mailbox).....	30
selecting from directory	26
Environment.....	37
Error tone	34

- F**
Fast access for the network mailbox..... 30
- G**
General troubleshooting..... 37
Group call 24
- H**
Handset
 activating/deactivating..... 19
 contact with liquid 38
 de-registering 14
 display language..... 12, 32
 earpiece volume 32
 handsfree volume..... 32
 idle status 18
 list 17
 muting 23
 registering 13
 restoring to default settings..... 34
 setting 32
 setting up 10
 transferring a call 24
Handsfree mode 23
Hash key 2, 19
Hearing aids 7
Help 37
- I**
Icon
 alarm clock 31
 for new messages 28
 keypad lock 19
 ringtone..... 34
Idle status
 display 15, 18
 returning to 18
Incorrect entries (correction) 17
Internal
 consultation..... 24
Internal call
 call waiting 25
- K**
Key 1 (quick dial) 2
Keypad lock 19
Keys
 assigning directory entry 27
 control key 2, 17
 delete key 4
 display keys 2, 4
 end call key..... 2, 23
 hash key 2, 19
 message key..... 2
 on/off key 2
 quick dial..... 2
 recall key..... 2
 shortcut..... 27
 star key 2
 talk key 2, 23
- L**
Language, display..... 12, 32
Liquid 38
List
 answering machine
 (dependent on base)..... 29
 handsets 17
 network mailboxes..... 28
Lock
 activating/deactivating keypad
 lock..... 19
- M**
Making calls
 accepting a call 23
 external 23
 internal 24
Manual redial 28
Medical equipment 7
Menu
 end tone 34
 tree 22
 using 18
Message key..... 2
 activating/deactivating flashing..... 29
 opening lists..... 28
Microphone 2
Muting the handset 23

Index

N

- Network mailbox..... 30
- Night mode, see Time control
- Number
 - copying to directory..... 28
 - entering netw. mailbox number..... 30
 - entering with directory..... 28
 - saving in the directory..... 26

O

- On/Off key.....2
- Order in directory..... 26

P

- Package contents.....8
- Power adapter.....7

Q

- Questions and answers..... 37

R

- Range.....9
- Recall key.....2
- Redial..... 28
- Registering (handset)..... 13
- Ringer
 - setting melody..... 33
- Ringtone
 - changing..... 33
 - setting volume..... 33

S

- Screen protection, see Screensaver
- Screensaver..... 32
- Searching in directory..... 26
- Sending
 - directory entry to handset..... 27
- Setting
 - date..... 14
 - melody (ringtone)..... 33
 - time..... 14
 - wake up time..... 31
- Setting up
 - base.....9
 - handset..... 10
- Shortcut..... 27
- SMS (dependent on base)
 - writing..... 40
- Snooze mode..... 31
- Sound, see Ringtone
- Specifications..... 39
- Star key.....2

T

- Talk key..... 2, 23
- Time control (night mode)..... 33

V

- Viewing network mailbox message..... 30
- Volume
 - earpiece..... 32
 - handset handsfree volume..... 32
 - loudspeaker..... 32
 - ringtone..... 33

W

- Writing and editing text..... 40

Issued by

Gigaset Communications GmbH
Frankenstr. 2a, D-46395 Bocholt

© Gigaset Communications GmbH 2012

All rights reserved. Subject to availability.

Rights of modification reserved.

www.gigaset.com

This user guide is made from 100% recycled paper.

Version: 02.04.2012



A31008 - M2252 - C401 - 1 - 7619