

OPERATING INSTRUCTIONS

accumet® 13636AP71 and 13636AP72

AP71 and AP72 Portable Waterproof pH/mV/°C Meter

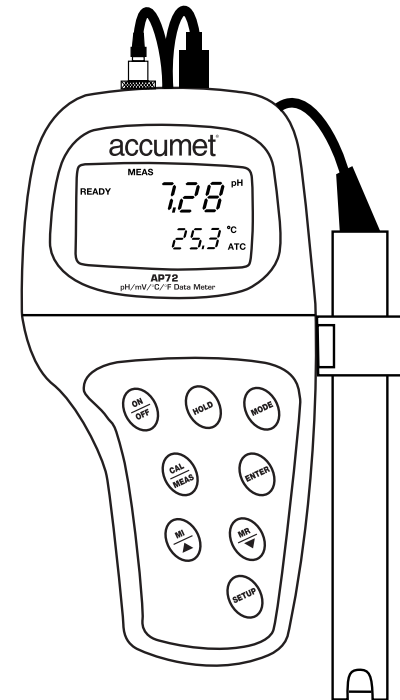

1/02

accumet®

accumet®

Table of Contents

1. Introduction	4
2. Display and keypad functions	5-6
2.1 Display	5
2.2 Keypad	6
3. Preparation	7-11
3.1 Inserting the batteries	7
3.2 Connecting the electrode and temperature probe	8-9
3.3 Attaching the electrode holder to the meter	10
3.4 Inserting the electrode into the electrode holder	11
4. Calibration	12-17
4.1 Important information on meter calibration	12
4.2 Preparing the meter for calibration	13
4.3 pH calibration	14-15
4.4 Relative mV calibration	16
4.5 Temperature calibration	17
5. Measurement	18-21
5.1 Automatic Temperature Compensation	18
5.2 Manual Temperature Compensation	19
5.3 Taking Measurements	20-21
6. Hold function	22
7. Memory functions	23-24
7.1 Memory Input	23
7.2 Memory Recall	24

8. Advanced setup functions	25-39
8.1 Advanced setup mode overview	26-27
AP71 meter	26
AP72 meter	27
8.2 Program 1.0: Memory clear	28
8.3 Program 2.0: Viewing previous calibration data	29
8.4 Program 3.0: Viewing electrode data	30-31
P3.1 Electrode offset	30
P3.2 Electrode slope	31
8.5 Program 4.0: Unit configuration	32-33
P4.1: READY indicator and auto endpoint function	32
P4.2: Selecting number of pH calibration points	33
P4.3: Calibration buffer selection sets (<i>AP72 meter only</i>)	34
P4.4 Selecting °C or °F (<i>AP72 meter only</i>)	35
8.6 Program 5.0: Resetting to factory default settings (<i>AP71 meter only</i>)	36
8.7 Program 5.0: Setting the real-time clock (<i>AP72 meter only</i>)	37-38
8.8 Program 6.0: Resetting to factory default settings (<i>AP72 meter only</i>)	39
9. Probe care and maintenance	40-41
10. Troubleshooting	42
11. Error Messages	43
12. Specifications	44

1. Introduction

Thank you for selecting an accumet meter. This accumet portable meter is a microprocessor-based instrument that measures pH, mV, and temperature. It's completely waterproof—and it floats! Your meter has many user-friendly features, all of which are accessible through the membrane keypad.

This meter includes two electrode holders and batteries.

Please read this manual thoroughly before operating your meter.

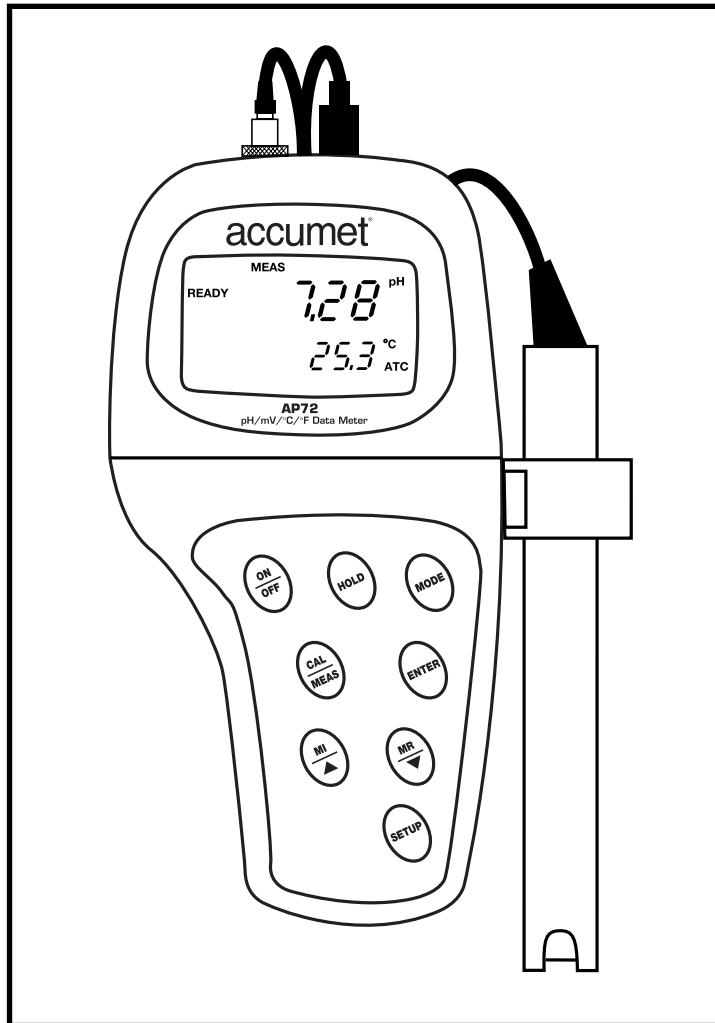

2. Display and Keypad Functions

2.1 Display

The LCD has a primary and secondary display.

- The primary display shows the measured pH, mV or Relative mV reading.
- The secondary display shows the temperature.

The display also shows error messages, keypad functions and program functions.

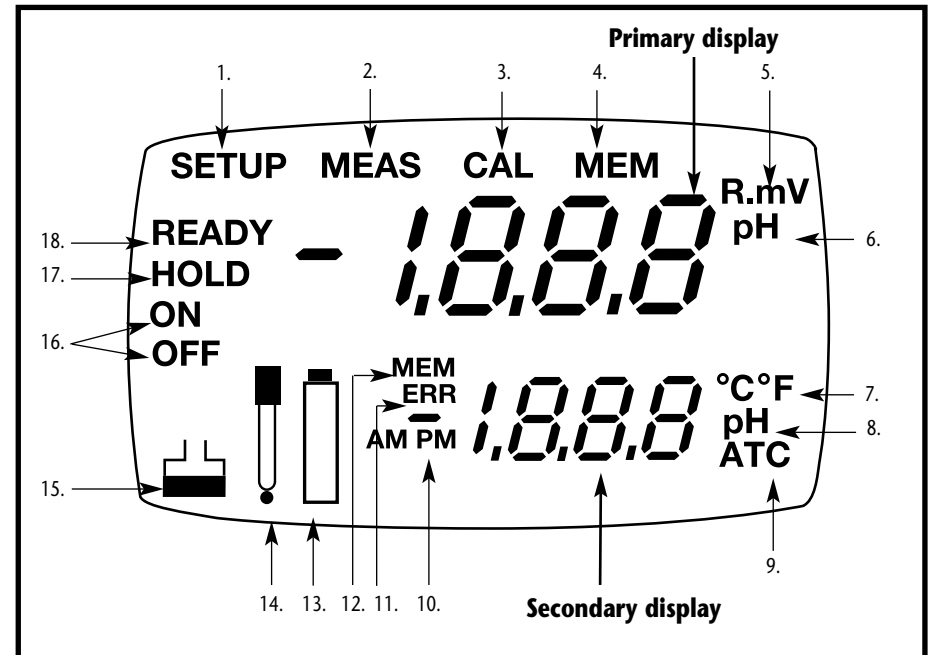

- | | | |
|--|--|--------------------------------------|
| 1. SETup mode indicator | 7. Temperature indicator
(°F available on AP72 meter only) | 12. MEMory location indicator |
| 2. MEASurement mode indicator | 8. pH buffer selection indicator | 13. Low battery indicator |
| 3. CALibration indicator | 9. Automatic Temperature Compensation indicator | 14. Probe indicator |
| 4. MEMory recall mode indicator | 10. Clock indicator
(AP72 meter only) | 15. Buffer indicator |
| 5. mV or relative mV indicator | 11. ERRor indicator | 16. Function ON/OFF indicator |
| 6. pH indicator | | 17. HOLD indicator |
| | | 18. READY indicator |

2.2 Keypad

The large membrane keypad makes the instrument easy to use. Each button, when pressed, has a corresponding graphic indicator on the LCD.

ON/OFF.....Powers and shuts off the meter.

HOLDFreezes the measured reading. To activate, press **HOLD** while in measurement mode. To release, press **HOLD** again.

AP72 model only: When auto endpoint feature is switched on, it automatically holds reading after 5 seconds of stability. The **HOLD** indicator appears on the display. Press **HOLD** to release auto endpoint feature.

MODE.....Selects the measurement parameter. Press **MODE** to toggle between pH; mV (or relative mV); and date/time (*date/time available on AP72 model only*). In pH calibration mode, press **MODE** to access temperature calibration.

CAL/MEAS.....Toggles user between Calibration and Measurement mode.

- If you were in pH measurement mode, press **CAL/MEAS** to enter pH calibration mode.
- If you were in mV measurement mode, press **CAL/MEAS** to enter mV calibration mode.

NOTE: Temperature calibration is available from pH calibration mode; see page 17 for directions.

In advanced set-up mode: Press **CAL/MEAS** to return to main menu from sub menus. Press **CAL/MEAS** again to return to measurement mode from main menu.

ENTERPress to confirm values in Calibration mode and to confirm selections in Setup mode.

MI / MRPress $\blacktriangle/\blacktriangledown$ in setup mode to scroll through subgroups. Also press $\blacktriangle/\blacktriangledown$ in mV calibration mode to adjust the calibration value.

MI/MR work in the measurement mode. **MI** (memory input) stores the measured value into memory. **MR** (memory recall) recalls the sets of values stored in the memory.

SET.....Press to enter **SETUP** mode. **SETUP** mode lets you customize meter preferences and defaults, and view calibration and electrode offset data.

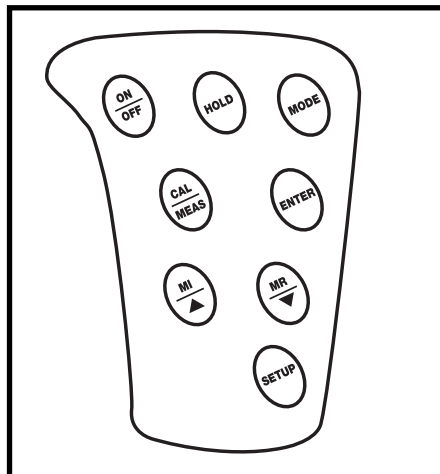

3. Preparation

3.1 Inserting the Batteries

Four AAA batteries are included with your meter.

1. Use a Phillips screwdriver to remove the two screws holding the battery cover. See figure below.
2. Lift off battery cover to expose batteries.
3. Insert batteries. Follow the diagram inside the cover for correct polarity.
4. Replace the battery cover into its original position. Screw cover back into place.

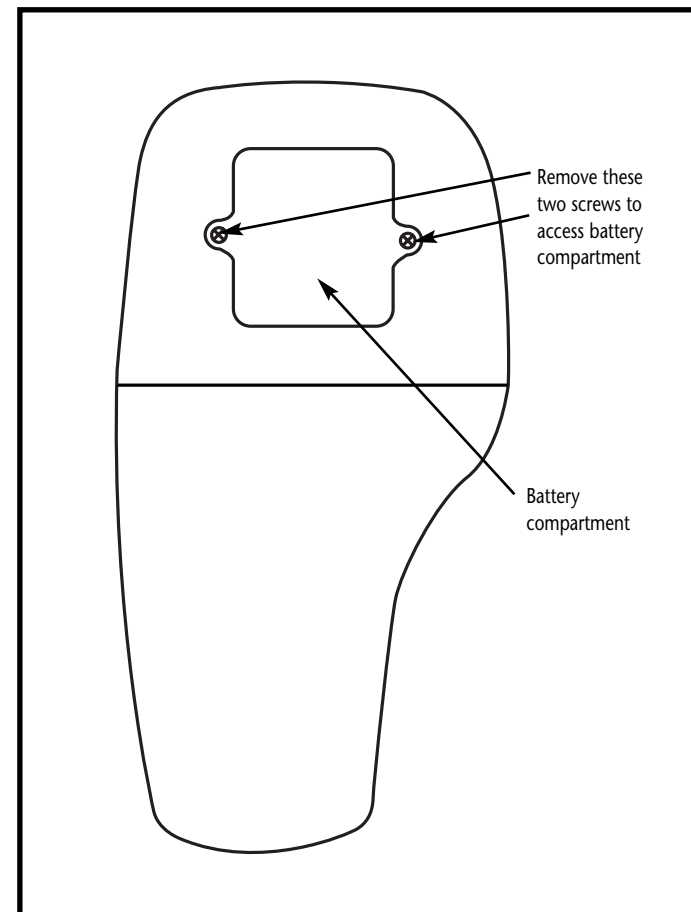

3.2 Connecting the Electrode and Temperature Probe

This accumet pH/mV meter can use any standard pH, ORP, or ISE electrode with a BNC connector. For automatic temperature compensation (ATC), this meter requires a temperature probe with a specialty 6-pin connector.

Use either:

- any electrode with a BNC connector and a separate temperature probe with 6-pin connector
- an "All-in-One" combination pH electrode/temperature probe designed specifically for the AP71 and AP72 waterproof meters

NOTE: Keep connectors clean. Do not touch connector with soiled hands.

To connect the pH, ORP or ISE electrode:

1. Slide the BNC connector of the probe over the BNC connector socket on the meter. Make sure the slots of the connector are in line with the posts of the socket. Rotate and push the connector clockwise until it locks.

See figure below.

2. To remove probe, push and rotate the connector counterclockwise. While holding onto the metal part of the connector, pull probe away from the meter.

CAUTION: Do not pull on the probe cord or the probe wires might disconnect.

To connect the temperature probe:

1. Line up the notch and 6 pins on the meter with the holes in the 6-pin connector. Push down and turn the locking ring clockwise to lock into place.

See figure below.

2. To remove probe, turn the locking ring counterclockwise on the probe connector. Pull probe away from the meter.

CAUTION: Do not pull on the probe cord or the probe wires might disconnect.

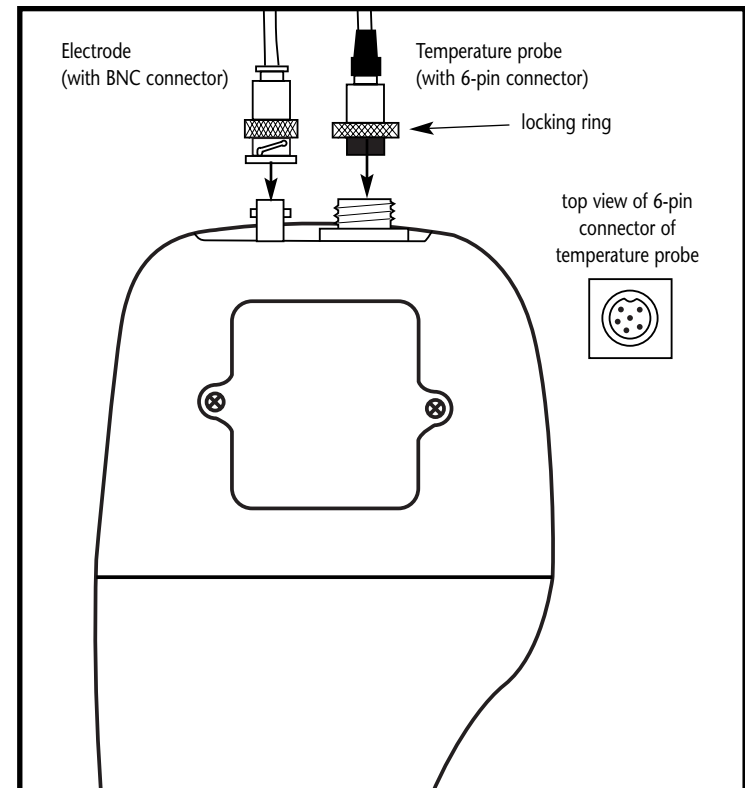

3.3 Attaching the Electrode Holder to the Meter

Attaching the electrode holder to the meter facilitates one-hand operation. Attach two electrode holders if you have a separate electrode and temperature probe.

1. Locate the slot on the left hand side of the meter.
2. Gently slide the flange of the holder into the slot on the meter. Make sure the holder is secured properly into the slot.

See figure **A**

You can attach the electrode holder in different positions.

See figure **B**

To attach a second electrode holder:

3. Align the flange of the second electrode holder with the slot of the first holder.

See figure **C**

4. Slide the flange of the second holder into the slot of the first holder until the tops of the holders are aligned and secure.

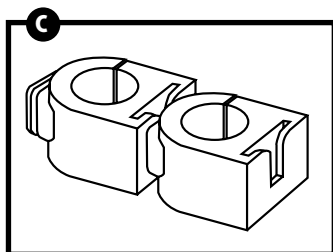
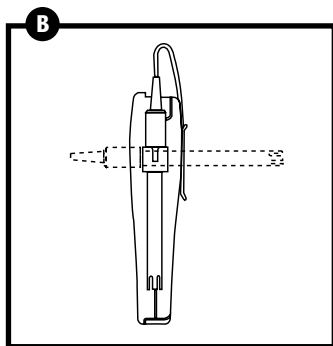
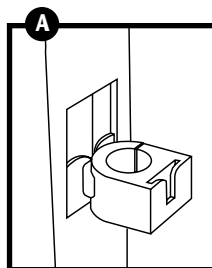

3.4 Inserting the Electrode into the Electrode Holder

Do not use excessive force when inserting electrodes into the holders.

1. Insert the pH electrode into the opening of the first holder until the top housing of the electrode touches the top of the holder.
2. If you are using a separate temperature probe, insert the probe into the opening of the second holder until the ridge on the housing touches the top of the holder.

NOTE: The holder is designed for probes 12 mm in diameter. Electrodes larger than 12 mm may not fit in the holder. Forcing the electrode into the opening may damage the holder or your electrode.

4. Calibration

4.1 Important Information on Meter Calibration

When you recalibrate your meter, old pH, Rel mV and mV calibration points are replaced on a point by point basis. For example, if you previously calibrated your meter at pH 4.01, 7.00, and 10.01, and you recalibrate at pH 7.00, the meter retains the old calibration data at pH 4.01 and pH 10.01. To view current calibration points, see Program P2.0 in the SETUP section, page 29.

To completely recalibrate your meter, or when you use a replacement probe, it is best to set the meter to its factory defaults and recalibrate the meter at all points. To reset the meter to its factory defaults, see the SETUP section Program P5.0, page 36 (for AP71 meter) or Program P6.0, page 39 (for AP72 meter).

For information on how to calibrate your meter:

- See section 4.3 on pages 14-15 for pH calibration
- See section 4.4 on page 16 for Relative mV calibration
- See section 4.5 on pages 17 for Temperature Calibration of replacement temperature probes or replacement “All-in-One” electrodes

4.2 Preparing the Meter for Calibration

Before starting calibration, make sure you are in the correct measurement mode. When you switch on the meter, the meter starts up in the units last used. For example, if you shut the meter off in "mV" units, the meter will read "mV" units when you switch the meter on.

Be sure to remove the protective electrode storage bottle or rubber cap of the probe before calibration or measurement. If the electrode has been stored dry, wet the probe in tap water for 10 minutes before calibrating or taking readings to saturate the pH electrode surface and minimize drift.

Wash your probe in deionized water after use, and store in electrode storage solution. If storage solution is not available, use pH 4.0 or 7.0 buffer.

Do not reuse buffer solutions after calibration. Contaminants in the solution can affect the calibration, and eventually the accuracy of the measurements.

AP71 meter calibration

The AP71 meter is capable of up to 5-point pH calibration to ensure accuracy across the entire pH range of the meter. Select from the following buffer options:

pH 1.68, 4.01, 7.00, 10.00, and 12.45.

The meter automatically recognizes and calibrates to these standard buffer values, which makes pH calibration faster and easier.

AP72 meter calibration

The AP72 meter features three separate buffer sets. Select the buffer set you require in Set Up mode Program 4.0 (see page 34 for more information). The AP72 meter is capable of up to 6-point pH calibration, depending on the buffer set. Select from the following buffer options:

USA buffers (pH 1.68, 4.01, 7.00, 10.00, 12.45)

NIST buffers (pH 1.68, 4.01, 6.86, 9.18, 12.45)

DIN buffers (pH 1.09, 3.06, 4.65, 6.79, 9.23, 12.75)

The meter automatically recognizes and calibrates to these standard buffer values, which makes pH calibration faster and easier.

4.3 pH calibration

NOTE: We recommend that you perform at least a 2-point calibration using standard buffers that bracket (one above and one below) the expected sample range. You can perform a 1-point calibration, but make sure that the buffer value is close to the sample value you are measuring.

1. If necessary, press the MODE key to select pH mode. The pH indicator appears in the upper right hand corner of the display.

See figure **A**

2. Rinse the probe thoroughly with de-ionized water or a rinse solution. Do not wipe the probe; this causes a build-up of electrostatic charge on the glass surface.

3. Dip the probe into the calibration buffer. The end of the probe must be completely immersed into the sample. Stir the probe gently to create a homogeneous sample.

4. Press CAL/MEAS to enter pH calibration mode. The CAL indicator lights. The primary display will show the measured reading while the smaller secondary display will indicate the pH standard buffer solution.

See figure **B**

5. Wait for the measured pH value to stabilize.

See figure **C**

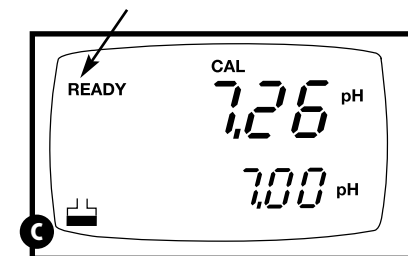
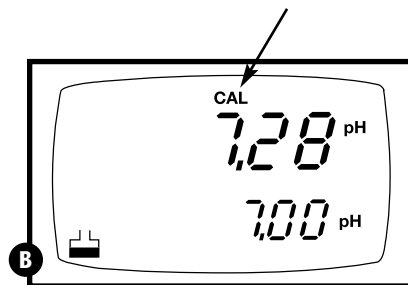
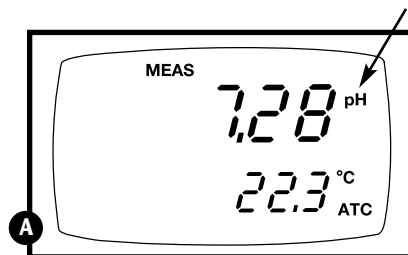

If the READY indicator has been activated (set up program P4.1—see page 32), the READY annunciator lights when the reading is stable.

6. Press ENTER to confirm calibration. The meter is now calibrated to the current buffer.

See figure **D**

- If you are performing multipoint calibration, go to step 7.
 - If you are performing one-point calibration, go to step 9.
7. Rinse the probe with de-ionized water or a rinse solution, and place it in the next pH buffer.
 8. Follow steps 5 to 8 for additional calibration points.
 9. When calibration is complete, press CAL/MEAS to return to pH measurement mode.

Notes

To exit from pH Calibration mode without confirming calibration, DO NOT press ENTER in step 6. Press CAL/MEAS instead.

If the selected buffer value is not within ± 1.0 pH from the measured pH value: the electrode and buffer icon blink and the ERR annunciator appears in the lower left corner of the display.

To limit the number of pH buffer values available during calibration, see section P4.2 on page 33.

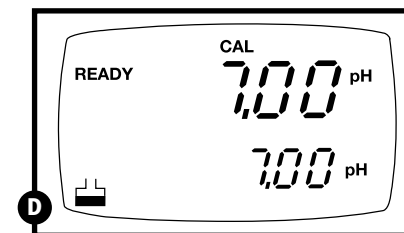

4.4 Relative mV Calibration

1. While in the measurement function, press **MODE** to enter the mV mode. The mV indicator appears in the upper right hand corner.

See figure **A**

2. Press the **CAL/MEAS** key. The **CAL** indicator appears above the primary display. The primary display shows the relative mV reading and the secondary display shows the absolute mV value.

NOTE: If you have never calibrated relative mV or if the meter has been reset, the value shown in the primary display is the same as the absolute mV value.

See figure **B**

3. Press the **▲** or **▼** keys to enter the relative mV value that matches your desired reading.

See figure **C**

4. Press the **ENTER** key to confirm the reading and to return to the measurement mode. The primary display now shows the relative mV reading. The RmV indicator appears in the upper right hand corner.

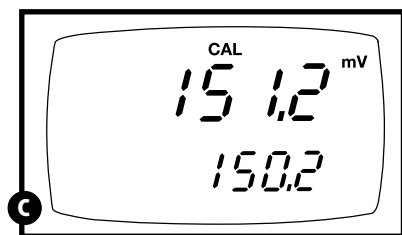
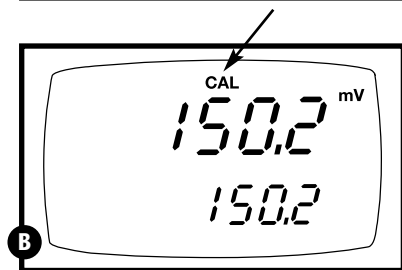
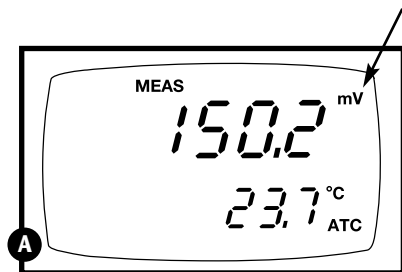

Notes

To view the mV offset value, use the **SETUP** mode Program P3.1. See page 30 for instructions.

The relative mV (RmV) indicator appears whenever the mV offset is not zero.

To reset the all calibration and offset values in memory to the factory default settings, use:

- *AP71 meter*: SETUP Program P 5.0. See page 36.
- *AP72 meter*: SETUP Program P6.0. See page 39.

4.5 Temperature Calibration

The temperature sensor is factory calibrated. Calibrate your sensor only if you suspect temperature errors that may have occurred over a long period of time or if you have a replacement probe.

Temperature calibration

1. Make sure the ATC probe (or temperature connector of the “All-in-One” electrode) is attached to the 6-pin connector. The ATC annunciator will appear at the right-hand side of the LCD.
2. Switch the meter on. Press the **MODE** key to select pH mode.
3. Press the **CAL/MEAS** key to enter pH calibration mode. The **CAL** indicator will appear above the primary display.
4. While in pH calibration mode, press the **MODE** key to enter temperature calibration mode. The primary display shows the temperature value with the last set offset and the secondary display shows the factory default temperature value.

See figure **A**

5. Dip the ATC probe (or “All-in-One” electrode) into a solution of known temperature (i.e. a temperature bath). Allow time for the temperature probe to stabilize.

6. Scroll with the **▼** and **▲** keys to set the correct temperature value (i.e. the temperature of the temperature bath). You can adjust the reading in increments of 0.1°C.

See figure **B**

7. Once you have selected the correct temperature, press the **ENTER** key. The meter automatically returns to pH measurement mode.

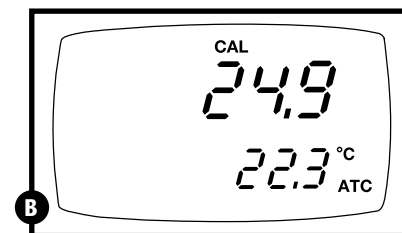
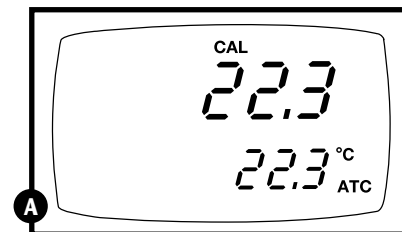

Notes

- You can offset the temperature reading up to $\pm 5^{\circ}\text{C}$ from the original reading.
- To exit this program without confirming the temperature calibration value, DO NOT press **ENTER** in step 7. Press **CAL/MEAS** instead.

5. Measurement

This meter is capable of taking measurements with automatic or manual temperature compensation. Automatic temperature compensation only occurs when a temperature sensor is plugged into the meter. If there is no temperature sensor plugged into the meter, the default manual temperature setting is automatically 25°C. You can manually set the temperature to match your working conditions using a separate thermometer.

5.1 Automatic Temperature Compensation

For automatic temperature compensation (ATC) simply plug the temperature probe into the meter (see page 9 for directions). The ATC indicator will light on the LCD.

See figure **A**

NOTE: If you are using a temperature probe, the probe must be submersed in the liquid you are measuring.

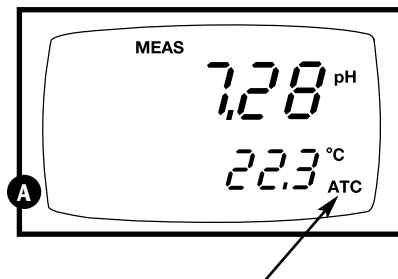

5.2 Manual Temperature Compensation

IMPORTANT: For manual compensation, you must disconnect the temperature probe (see page 9).

1. Switch the meter on. Press the **MODE** key to select pH mode.
2. Press the **CAL/MEAS** key to enter pH calibration mode. The CAL indicator will appear above the primary display.
3. While in pH calibration mode, press the **MODE** key to enter temperature calibration mode. The primary display and secondary display show the last set value.

See figure **A**

4. Check the temperature of your sample using an accurate thermometer.
5. Press the **▲** or **▼** keys to offset the temperature to the measured value from step 4.

See figure **B**

6. Press **ENTER** to confirm the selected temperature and to return to the pH measurement mode.

The meter will now compensate pH readings for the manually set temperature.

Notes

To exit this program without confirming the manual temperature compensation value, DO NOT press **ENTER** in step 6. Press **CAL/MEAS** instead.

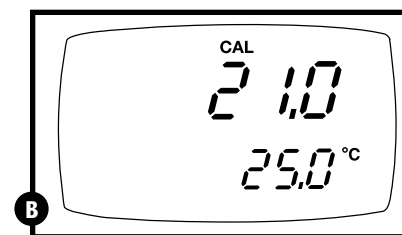
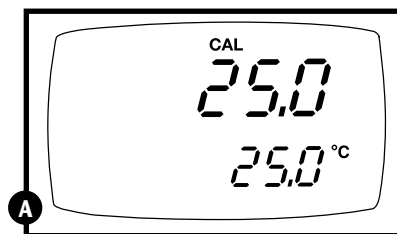

5.3 Taking Measurements

Be sure to remove the electrode soaker bottle or protective rubber cap on the electrode before measurement.

To take readings:

- 1. Rinse the probe with deionized or distilled water before use** to remove any impurities adhering to the probe body. If the pH electrode has dehydrated, soak it for 30 minutes in electrode storage solution or a 2M–4M KCl solution.
- 2. Press ON to switch on meter.** The MEAS annunciator appears on the top center of the LCD. The ATC indicator appears in the lower right hand corner to indicate Automatic Temperature Compensation (See page 19 to set Manual Temperature Compensation).

See figure **A**

- 3. Dip the probe into the sample.**

When dipping the probe into the sample, the sensor or the glass bulb of the electrode must be completely immersed into the sample. Stir the probe gently in the sample to create a homogenous sample.

- 4. Allow time for the reading to stabilize.**
Note the reading on the display.
- 5. To toggle between pH and mV (or Rel mV) readings, press the MODE key.**

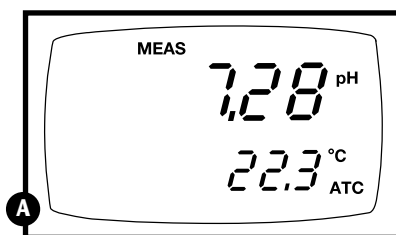

Taking measurements with READY indicator selected on

If the READY indicator has been activated, the **READY** annunciator lights when the reading is stable*. Switch the READY indicator on or off in Set up program P4.1—see page 32 for directions.

*The READY indicator appears and the reading holds until the measured value exceeds the tolerance (± 0.02 pH; ± 0.8 mV <400 ; ± 1.2 mV >400). Then, the **READY** annunciator turns off.

Taking measurements with the auto endpoint feature selected on

NOTE: this feature is available on model AP72 only.

When a reading is stable for more than 5 seconds, the auto endpoint feature will automatically “hold” the reading. The “hold” indicator appears on the left side of the display. Press the HOLD key to release the reading. Switch the Auto endpoint feature on or off in Set up program P4.1—see page 32 for directions.

6. HOLD function

This feature lets you freeze the value of the pH, mV (or Relative mV) and temperature readings for a delayed observation. **HOLD** can be used any time when in **MEAS** mode.

1. To hold a measurement, press the **HOLD** key while in measurement mode. "HOLD" will appear on the display.

See figure **A**

2. To release the held value, press **HOLD** again. Continue to take measurements.

NOTE: This meter shuts off automatically after 30 minutes of nonuse. If the meter is shut off either automatically or manually, the **HOLD** value will be lost. For longer storage, use the memory functions (see pages 23-24).

NOTE: *For AP72 model only:* The AP72meter has an auto endpoint feature. When this feature is switched on, the display will automatically "hold" a reading that has been stable for more than 5 seconds. The "hold" indicator appears. Press the **HOLD** key to release the reading.

To switch on or off the auto endpoint feature, see Set up program P4.1 on page 32.

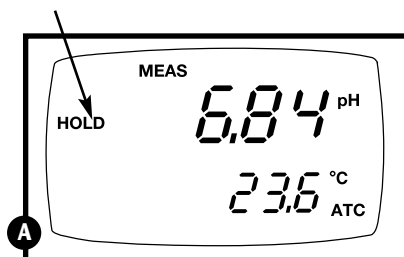

7. Memory functions

7.1 Memory Input

Your meter stores data in sets:

- pH and temperature
- mV (or relative mV) and temperature.

AP71 meter: The AP71 meter can store up to 16 sets of data in any combination of values. For example, you can store 7 pH and 9 mV values.

AP72 meter: The AP72 meter can store up to 50 sets of data in any combination of values. In addition to the standard data set, the AP72 meter also stores the date and time the reading was stored.

To store a reading:

1. During any measurement function (**MEAS**), press the **MI** key to input any data into the memory
2. **MEM**, "Sto" and memory number will flash. The meter then returns to measurement mode.

See figure **A**

NOTE: If the memory is full, the first value stored will be erased to create space for the new value.

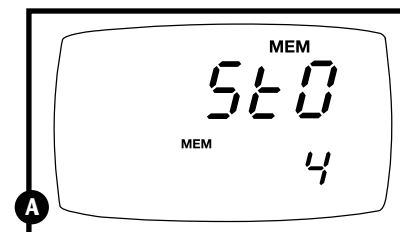

7.2 Memory Recall

This function recalls the previous readings stored in the memory. You can only access MR from the MEASUREMENT mode. Memory recall is in “Last In First Out” order.

To recall readings:

1. Press the MR key once to retrieve the last reading stored. The memory location screen—MEM, “Loc” and the memory number—will flash on the display.

See figure **B**

2. Press the ENTER key to recall the reading stored under that memory number.

See figure **C**

3. *AP71 meter only:* Press the ENTER key again to return to the “memory location” screen.

AP72 meter only: Press the ENTER key again to view the date and time the reading was taken. Press the ENTER key again to return to the “memory location” screen.

See figure **D**

4. The display automatically moves to the next memory location screen.

See figure **E**

5. If necessary, press the ▲ key to select the next “memory location” screen; press the ▼ key to select the previous “memory location” screen.

6. Repeat steps 2-5 to review additional stored data sets.

7. To exit Memory Recall, press the MEAS key to return to the Measurement mode.

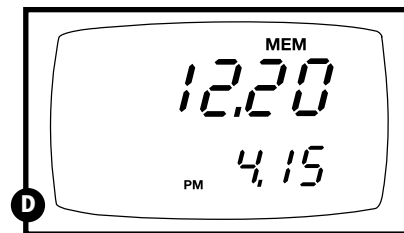
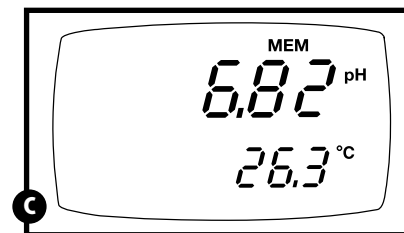
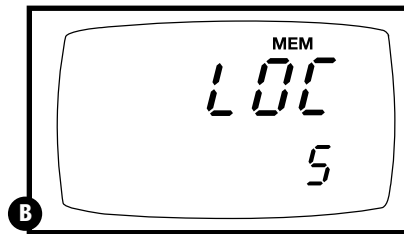

Time/date appears on AP72 meter display only

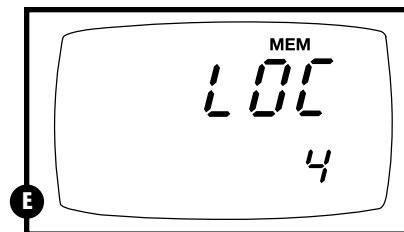

Notes

Readings stored in memory are retained even if the unit is turned off. To erase all readings stored in memory, use the SETUP mode P1.0 on page 28.

8. Advanced set up functions

The advanced set up mode lets you customize your meter’s preferences and defaults. Your waterproof meter features different sub groups that organize all set-up parameters.

The sub groups are:

1. P1.0: Memory clear (CLR)
2. P2.0: Viewing calibration data (CAL)
3. P3.0: Viewing electrode data (ELE)
4. P4.0: Unit configuration (COF)
5. *AP71 only:* P5.0: Reset to factory default settings (rSt)
6. *AP72 only:* P6.0: Setting clock (CLO)

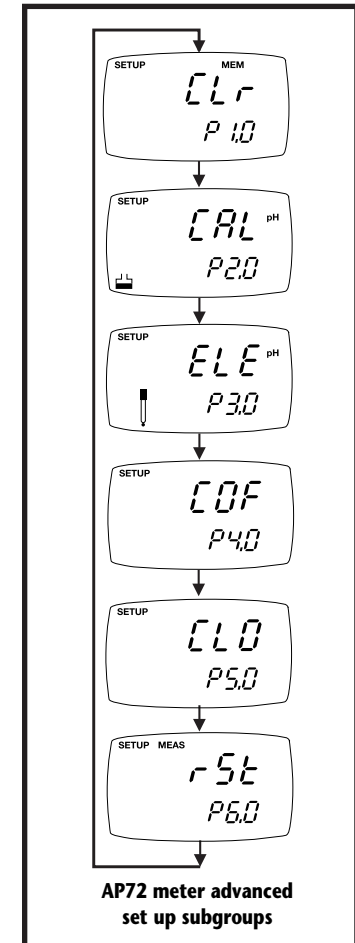
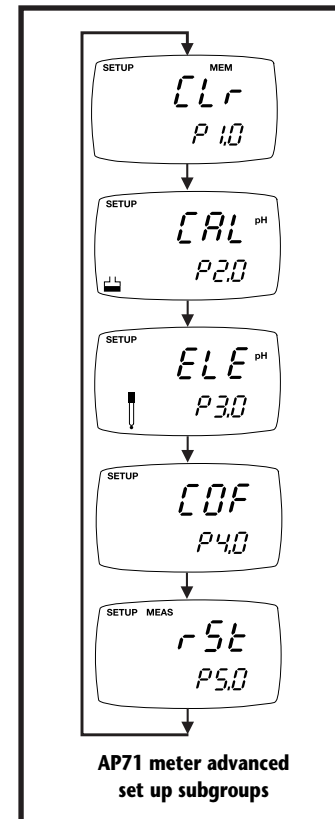

8.1 Advanced set-up mode overview

Press the SETUP key to enter Set up mode.

Press the ▲ and ▼ keys to scroll through sub groups.

AP71 meter set up mode

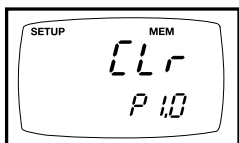

Instructions on page 28

P1.0: Memory clear

- P1.0 Clear all stored readings

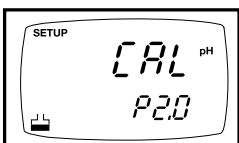

Instructions on page 29

P2.0: Viewing previous calibration data

- P2.1: First calibration point
- P2.2: Second calibration point
- P2.3: Third calibration point
- P2.4: Fourth calibration point
- P2.5: Fifth calibration point

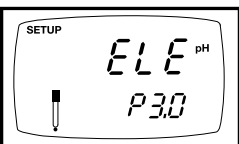

Instructions on page 30-31

P3.0: Viewing electrode data

In pH measurement mode:

- P3.1: pH electrode offset
- P3.2: pH electrode slope

In mV (or relative mV) measurement mode:

- P3.1: relative mV offset

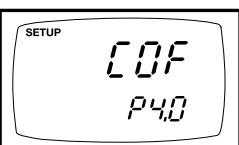

Instructions on pages 32-33

P4.0: Unit configuration

- P4.1: Ready indicator on or off
- P4.2: # of calibration points: 2, 3, 4, or 5

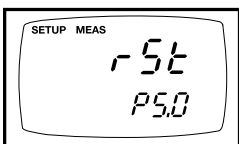

Instructions on page 36

P5.0: Reset to factory default

- P5.0: Reset to factory default settings

AP72 meter set up mode

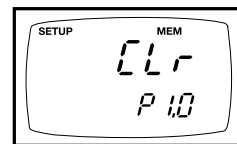

Instructions on page 28

P1.0: Memory clear

- P1.0 Clear all stored readings

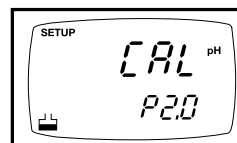

Instructions on page 29

P2.0: Viewing previous calibration data

- P2.1: First calibration point (plus time/date)
- P2.2: Second calibration point (plus time/date)
- P2.3: Third calibration point (plus time/date)
- P2.4: Fourth calibration point (plus time/date)
- P2.5: Fifth calibration point (plus time/date)
- P2.6: Sixth calibration point (plus time/date)-only available when DIN buffer set is selected in P4.3

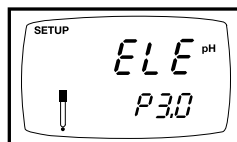

Instructions on page 30-31

P3.0: Viewing electrode data

In pH measurement mode:

- P3.1: pH electrode offset
- P3.2: pH electrode slope

In mV (or relative mV) measurement mode:

- P3.1: relative mV offset

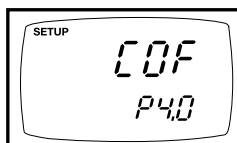

Instructions on pages 32-35

P4.0: Unit configuration

- P4.1: Ready indicator on or off
- P4.2: # of calibration points: 2, 3, 4, 5, or 6 (6th point available for DIN buffer set only)
- P4.3: Select calibration buffer set: USA, DIN, or NIST
- P4.4: Select °C or °F

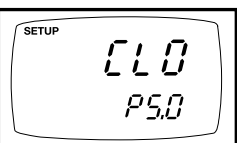

Instructions on pages 37-38

P5.0: Setting Clock

- Setting year
- Setting date (month/day)
- Setting time (hour/minute/second)

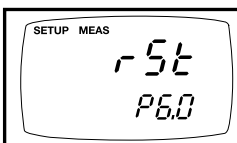

Instructions on page 39

P6.0: Reset to factory default

- P6.0: Reset to factory default settings

8.2 P1.0: Memory Clear

Use this parameter to clear all memory values when you need to store a new series of values. This lets you avoid confusing the old values with the new ones. NO is the default setting.

NOTE: Selecting YES will wipe out all memory.

From measurement mode:

1. Press the Set up key to enter Set Up mode.
2. Press the ▲ and ▼ keys to scroll through subgroups until you view parameter P1.0.

See figure A

3. Press the ENTER key to enter parameter P1.0.

4. Press the ▲ and ▼ keys to toggle between NO and YES.
 - NO retains current memory
 - YES clears all memory

See figure B

5. Press the ENTER key to confirm selection and return to the subgroup menu. Press the CAL/MEAS key to return to measurement mode.

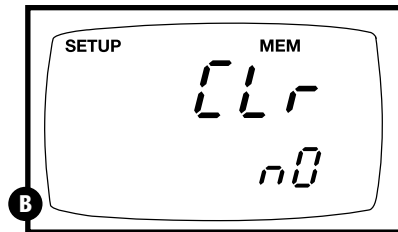
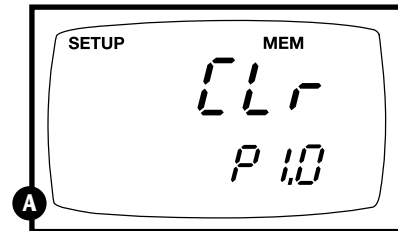

8.3 P2.0: Viewing previous calibration data

This mode lets you recall previous calibration data, which helps you know when to recalibrate your meter. This is a “view only” mode.

From measurement mode:

1. Press the Set up key to enter Set Up mode.

See figure A

2. Press the ▲ and ▼ keys to scroll through subgroups until you view parameter P2.0.
3. AP71 meter only: Press the ENTER key repeatedly to view previous calibration data.

See figure B

AP72 meter only: Press the ENTER key repeatedly to view previous calibration data. The meter will first display the calibration point, and then display the date and time of calibration.

See figures B and C

4. When you have scrolled through all calibration data, you will automatically return to the subgroup menu. Press the CAL/MEAS key to return to measurement mode.

Notes

If there is no previous calibration data at a particular point, the primary display will show “----”.

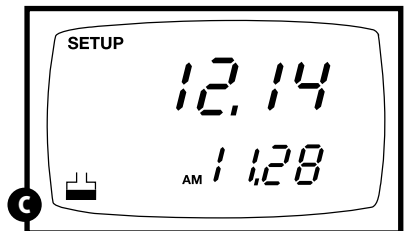
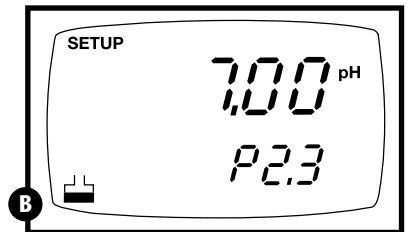
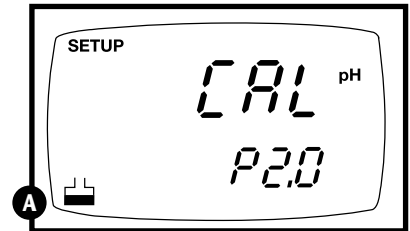

Time/date appears on AP72 meter display only

8.4 P3.0: Viewing electrode data

Program 3 has two “view only” options that lets you check the electrode parameters for diagnostic purposes.

P3.1: Electrode offset

From measurement mode

1. Press the Setup key to enter Set Up mode.
2. Press the ▲ and ▼ keys to scroll through subgroups until you view parameter P3.0.

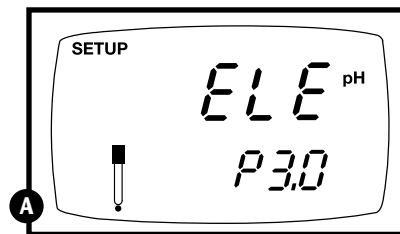

See figure **A**

3. Press the ENTER key to select parameter 3.1.
4. The display shows the electrode offset value.
 - If you are in pH measurement mode, the display shows the mV offset at pH 7.00. If you have not calibrated at any buffer, the primary display shows 0.0 mV.

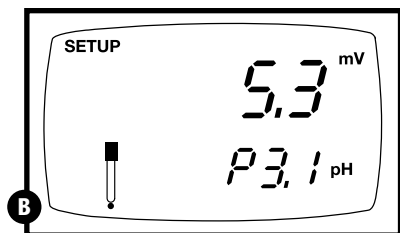

See figure **B**

- If you are in mV measurement mode, the display shows the relative mV offset. You can adjust the relative mV offset in relative mV calibration mode—see page 16 for instructions.

See figure **C**

5. Press the ENTER key to proceed to step 4 of P3.2. Or, press the CAL/MEAS key to return to measurement mode.

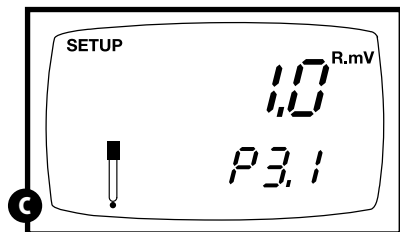

P3.2: Electrode slope

NOTE: this parameter is available in pH measurement mode only.

From measurement mode

1. If necessary, press the MODE key to select pH measurement mode. Press the Setup key to enter Set Up mode.
 2. Press the ▲ and ▼ keys to scroll through subgroups until you view parameter P3.0.
- See figure **D**
3. Press the ENTER key twice to select parameter 3.2.
 4. The display shows electrode slope in percentage. Slope displayed is the average slope based on the pH calibrations. Default setting is 100.0.

See figure **E**

5. Press the ENTER key to return to the subgroup menu. Press the CAL/MEAS key to return to measurement mode.

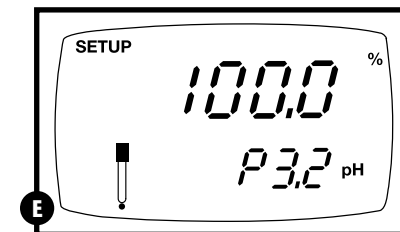
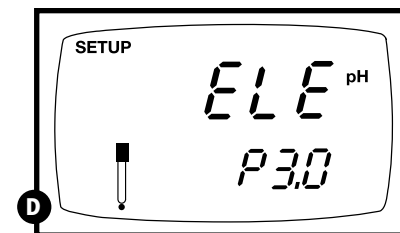

8.5 P4.0: Unit configuration

P4.1: READY indicator and auto endpoint function

Program P4.1 lets you select “READY indicator on” to indicate when the reading is stable*, or select “READY indicator off” for faster meter response.

AP72 meter only: Program P4.1 also lets you switch the Auto endpoint function on or off. Select auto endpoint on to “hold” the reading when it is stable for more than 5 seconds. The display automatically freezes, and the HOLD indicator appears on the left side of the display. Press the HOLD key to release the display and access other functions. Select auto endpoint off to deactivate this feature.

From measurement mode

1. Press Setup key to enter Set Up mode.
2. Press the ▲ and ▼ keys to scroll through subgroups until you view parameter P4.0.

See figure **A**

3. Press the ENTER key to select parameter 4.1.

See figure **B**

4. Press the ▲ and ▼ keys to select the configuration you require.
 - OFF switches the READY indicator off.
 - ON switches the READY indicator on.
 - *AP72 meter only:* ON and HOLD together switches the auto endpoint feature on.

5. Press the ENTER key to confirm selection and to proceed to step 4 of P4.2. Press the CAL/MEAS key to return to measurement mode.

Notes

Meter default is set for Ready indicator on, and auto endpoint function off.

*The READY indicator appears and the reading holds until the measured value exceeds the tolerance (± 0.02 pH; ± 0.8 mV <400; ± 1.2 mV >400). Then, the READY annunciator turns off.

P4.2: Selecting number of pH calibration points

Program P4.2 lets you select the number of calibration points that appear in pH calibration mode: 2, 3, 4, or 5. This lets the meter scroll through the calibration points more quickly if you regularly calibrate at less than 5 points.

From measurement mode

1. Press Setup key to enter Set Up mode.
2. Press the ▲ and ▼ keys to scroll through subgroups until you view parameter P4.0.

See figure **C**

3. Press the ENTER key twice to select parameter 4.2.

See figure **D**

4. Press the ▲ and ▼ keys to select 2, 3, 4, or 5 point pH calibration.
5. Press the ENTER key to confirm selection and to return to the subgroup menu. Press the CAL/MEAS key to return to measurement mode.

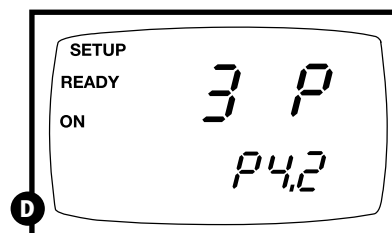
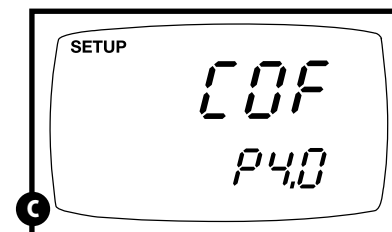
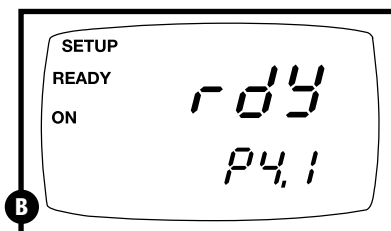
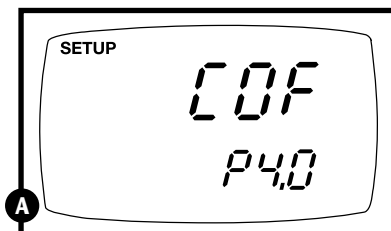

P4.3 Calibration buffer selection sets

Available in AP72 meter only

The AP72 meter lets you select between three standard calibration buffer sets, depending on your requirements. The available sets are USA, NIST, and DIN standard calibration buffers.

From measurement mode

1. Press Setup key to enter Set Up mode.
2. Press the ▲ and ▼ keys to scroll through subgroups until you view parameter P4.0.

See figure **E**

3. Press the ENTER key three times to select parameter 4.3.

See figure **F**

4. Press the ▲ and ▼ keys to select the buffer set you require:

- USA buffers
(pH 1.68, 4.01, 7.00, 10.00, 12.45)
- NIST buffers
(pH 1.68, 4.01, 6.86, 9.18, 12.45)
- DIN buffers
(pH 1.09, 3.06, 4.65, 6.79, 9.23, 12.75)

5. Press the ENTER key to confirm selection and to return to the subgroup menu. Press the CAL/MEAS key to return to measurement mode.

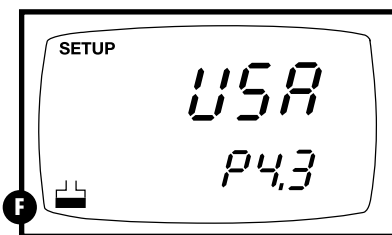
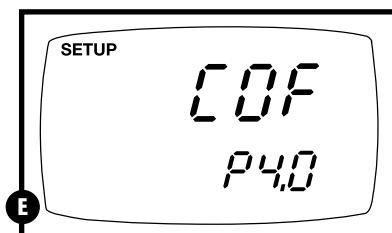

P4.4 Selecting °C or °F

Available in AP72 meter only

The AP72 meter lets you select between °C and °F units for temperature readings.

From measurement mode

1. Press Setup key to enter Set Up mode.
2. Press the ▲ and ▼ keys to scroll through subgroups until you view parameter P4.0.

See figure **G**

3. Press the ENTER key four times to select parameter 4.4.

See figure **H**

4. Press the ▲ and ▼ keys to toggle between °C and °F.
5. Press the ENTER key to confirm selection and to return to the subgroup menu. Press the CAL/MEAS key to return to measurement mode.

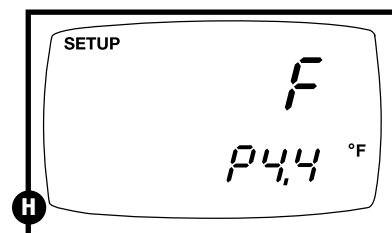
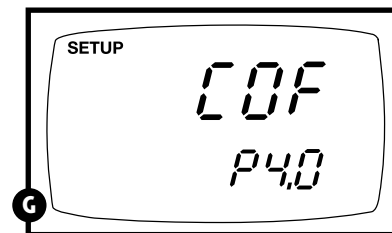

8.6 P5.0: Resetting to factory default settings

Available in AP71 meter only

In the AP71 meter, Program 5 lets you reset all parameters to factory default settings. This clears all calibration data, memory, and any other setup functions you might have changed.

From measurement mode

1. Press **Setup** key to enter Set Up mode.
2. Press the **▲** and **▼** keys to scroll through subgroups until you view parameter P5.0.

See figure **A**

3. Press the **ENTER** key to enter parameter P5.0.

See figure **B**

4. Press the **▲** and **▼** keys to toggle between NO and YES.
 - NO retains current settings
 - YES resets to factory default settings
5. Press the **ENTER** key to confirm selection and to return to the subgroup menu. Press the **CAL/MEAS** key to return to measurement mode.

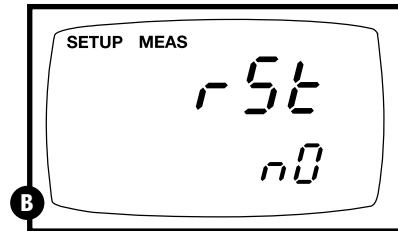
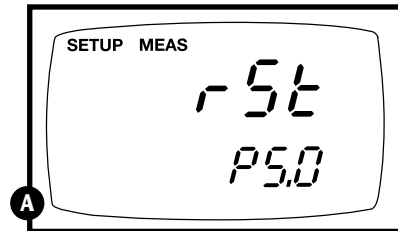

8.7 P5.0: Setting the real-time clock

Available in AP72 meter only

The AP72 meter features a real-time calendar and clock. This helps you meet GLP (Good Laboratory Practice) standards.

From measurement mode

1. Press **Setup** key to enter Set Up mode.
2. Press the **▲** and **▼** keys to scroll through subgroups until you view parameter P5.0.

See figure **A**

3. Press the **ENTER** key to enter parameter P5.0. The meter lets you select the century: "19-" or "20-". The century digits will flash.

See figure **B**

4. Press the **▲** and **▼** keys to toggle to the correct century.
5. Press the **ENTER** key to confirm the century and move to "year" selection. The "year" digits will flash.

See figure **C**

6. Press the **▲** and **▼** keys to toggle to the correct year.
7. Press the **ENTER** key to confirm the year and move to "month" selection. The "month" digits will flash.

See figure **D**

8. Press the **▲** and **▼** keys to toggle to the correct month.
9. Press the **ENTER** key to confirm the month and move to "date" selection. The "date" digits will flash.

See figure **E**

10. Press the **▲** and **▼** keys to toggle to the correct date.

continued on next page

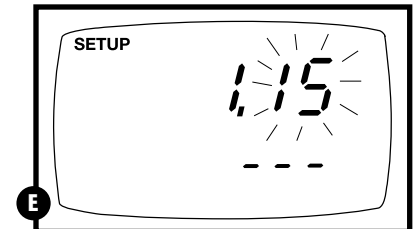
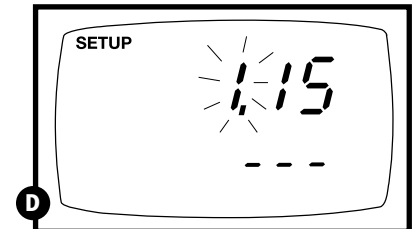
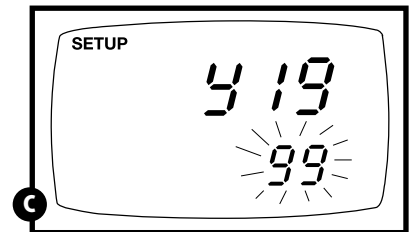
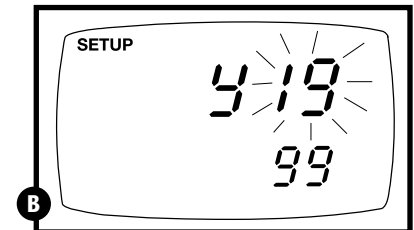
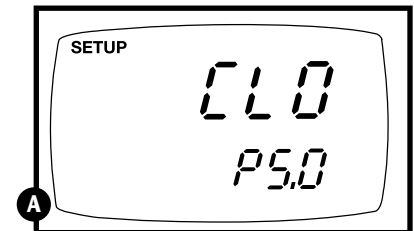

- 11. Press the ENTER key** to confirm the date and move to “hour” selection. The “hour” digits will flash.

See figure **F**

- 12. Press the ▲ and ▼ keys** to toggle to the correct hour. Note the “AM” and “PM” indicator on the lower portion of the display.

- 13. Press the ENTER key** to confirm the hour and move to “minute” selection. The “minute” digits will flash.

See figure **G**

- 14. Press the ▲ and ▼ keys** to toggle to the correct minutes.

- 15. Press the ENTER key** to confirm the minutes and move to “second” selection. The “second” digits will flash.

See figure **H**

- 16. Press the ▲ and ▼ keys** to toggle to the correct seconds.

- 17. Press the ENTER key** to confirm the seconds and return to “century” selection.

- 18. Press the CAL/MEAS key** to return to the subgroup menu. Press the CAL/MEAS key again to return to measurement mode.

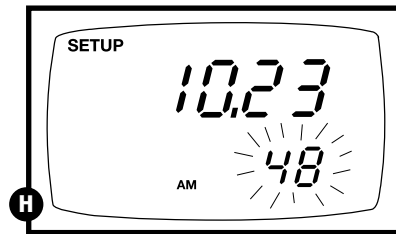
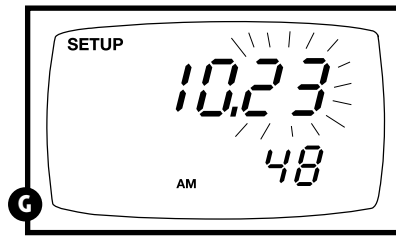
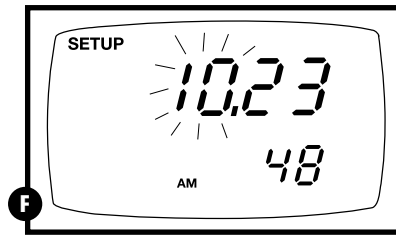

8.8 P6.0: Resetting to factory default settings

Available in AP72 meter only

In the AP72 meter, Program 6 lets you reset all parameters to factory default settings. This clears all calibration data, memory, and any other setup functions you might have changed.

From measurement mode

- 1. Press Setup key** to enter Set Up mode.

- 2. Press the ▲ and ▼ keys** to scroll through subgroups until you view parameter P6.0.

See figure **A**

- 3. Press the ENTER key** to enter parameter P6.0.

See figure **B**

- 4. Press the ▲ and ▼ keys** to toggle between NO and YES.

- NO retains current settings
- YES resets to factory default settings

- 5. Press the ENTER key** to confirm selection and to return to the subgroup menu. Press the CAL/MEAS key to return to measurement mode.

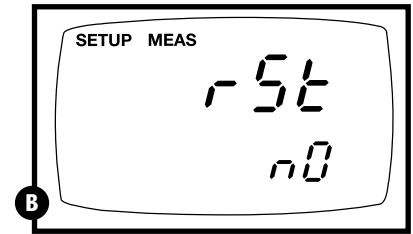
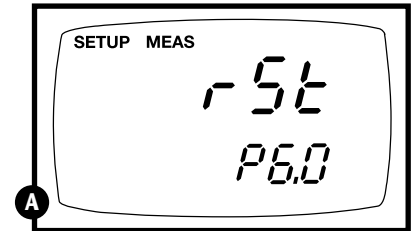

Notes

Press the CAL/MEAS key at any point while setting the time to return to the subgroup menu.

9. Probe Care and Maintenance

Since your pH electrode is susceptible to dirt and contamination, clean it every one to three months depending on the extent and condition of use.

NOTE: for specialty electrode care, consult the instruction manual included with your electrode.

pH electrode storage

For best results, always keep the pH bulb wet. Use the protective electrode storage bottle or rubber cap filled with electrode storage solution to store your electrode. Also, you can store in a pH 4 buffer with 1/100 part of saturated KCl. Other pH buffers are OK for storage, but NEVER use distilled water for storage.

After measuring

1. Rinse the pH electrode and reference junction in de-ionized water.
2. **Store the electrode as recommended above in “pH electrode storage,” or as recommended by the manufacturer.**
3. Prior to next use, rinse the liquid junction with de-ionized water and tap dry—**never wipe electrode.**

NOTE: If this does not restore electrode to normal response, see “Reactivating the pH electrode” section below.

pH electrode cleaning

Salt deposits: dissolve the deposits by immersing the electrode in tap water for ten to fifteen minutes. Ten thoroughly rinse with distilled water.

Oil/grease film: wash electrode pH bulb gently in some detergent and water. Rinse electrode tip with distilled water or use a general purpose electrode cleaner.

Clogged reference junction: heat a diluted KCl solution to 60 to 80°C. Place the sensing part of the electrode into the heated solution for about 10 minutes. Allow the electrode to cool in some unheated KCl solution.

Protein deposits: prepare a 1% pepsin solution in 0.1 M of HCl. Set the electrode in the solution for five to ten minutes. Rinse the electrode with distilled water.

Reactivating the pH electrode

If stored and cleaned properly, your pH electrode should be ready for immediate use. However, a dehydrated bulb may cause sluggish response. To rehydrate the bulb, immerse the electrode in a pH 4 buffer solution for 10 to 30 minutes. If this fails, the electrode requires activation. **Never touch or rub glass bulb. Contact builds up an electrostatic charge.**

pH electrode activation (for glass bodied electrodes only)

WARNING: Only qualified persons proficient with the safe handling of dangerous chemicals should perform the procedure below. Provide proper containers, fume hoods, ventilation, and waste disposal. Safety goggles and protective clothing must be worn while performing this procedure. If possible, replace with another electrode instead of performing this reactivation procedure.

1. **Dip or stir the pH electrode** in alcohol for 5 minutes.
2. **Leave the electrode in tap water** for 15 minutes.
3. **Dip and stir the electrode** in concentrate acid (such as HCl or H₂SO₄) for five minutes.
4. **Repeat step 2.**
5. **Dip and stir in strong base** (NaOH) for five minutes.
6. **Leave for 15 minutes** in distilled or deionized water.
7. **Now test with standard calibration buffer solutions** to see if the electrode yields acceptable results. You may repeat step 3 through 6 up to three times for better response. If the response does not improve, then your electrode is no longer functioning. Replace with a new electrode.

10. Troubleshooting

Problem	Cause	Solution
Power on but no display	<ul style="list-style-type: none"> a) Batteries not in place. b) Batteries not in correct polarity (+ and -). c) Weak batteries. 	<ul style="list-style-type: none"> a) Check that batteries are in place and making good contact. b) Reinsert batteries with correct polarity. c) Replace batteries or attach optional AC adapter.
Unstable readings	<ul style="list-style-type: none"> a) Air bubbles in probe. b) Dirty probe. c) Probe not deep enough in sample. d) External noise pickup or induction caused by nearby electric motor. e) Broken probe. 	<ul style="list-style-type: none"> a) Tap probe to remove bubbles. b) Clean the probe and recalibrate. c) Make sure sample entirely covers the probe sensors. d) Move or switch off interfering motor. e) Replace probe.
Slow response	<ul style="list-style-type: none"> a) Dirty/Oily probe. 	<ul style="list-style-type: none"> a) Clean probe. See "Probe Care & Maintenance", page 40.

11. Error Messages

LCD Display	Indicates	Cause	Solution
Err annunciator	Unrecognized input from keypad	Wrong input in selected mode.	Release key. Select valid operations depending on mode.
CAL & Err annunciators on/ Buffer and electrode indicators blink	Calibration error	Wrong buffer value input at calibration. Dirty probe.	Check your buffer input value, clean probe. See Calibration sections or Probe Maintenance section.
Battery indicator blinks	Low battery level	Need new batteries or battery connection is bad	Clean battery contacts. Replace batteries with fresh ones, noting polarity

If an error message appears in the primary display (the upper row of larger digits), switching off the meter and switching it on again may eliminate the error message.

See figure **A**

If error persists, or the meter shows incorrect values, return the meter.

For a complete diagram of the display, see page 5.

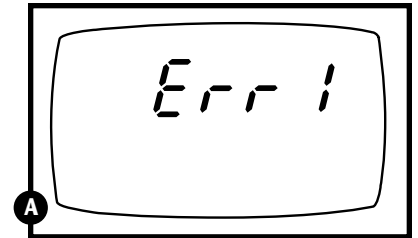

ERR 1 in primary display

12. Specifications

Mode	pH	Temperature	mV
Range	-2.00 to 16.00 pH	-10.0 to 110.0°C (also 14.0 to 230.0°F for AP72 meter)	-2000 to 2000 mV (same for Rel mV)
Resolution	0.01 pH	0.1°C (also 0.1°F for AP72 meter)	0.1 mV between ±199.9 mV 1 mV beyond ±199.9 mV
Accuracy	±0.01 pH	±0.5°C (also ±0.5°F for AP72 meter)	±0.2 mV between ±199.9 mV ±2 mV beyond ±199.9 mV
Input	BNC connector	6-pin plug	BNC connector

Calibration

AP71 meter: Up to five points (pH 1.68, 4.01, 7.00, 10.00, 12.45)

AP72 meter: Up to six points—select from three different buffer sets:

USA buffers (pH 1.68, 4.01, 7.00, 10.00, 12.45)

NIST buffers (pH 1.68, 4.01, 6.86, 9.18, 12.45)

DIN buffers (pH 1.09, 3.06, 4.65, 6.79, 9.23, 12.75)

Temperature: Offset in 0.1°C increments

mV: Offset up to ±150 mV

Memory:

AP71 meter: up to 16 data sets (pH or mV plus temperature)

AP72 meter: up to 50 data sets (pH or mV plus temperature, date, and time)

pH slope range: 80% to 110%

Temperature compensation: automatic (ATC) or manual from 0 to 100°C

Operating temperature: 0 to 50°C

Power: four 1.5 V AAA batteries (included)

Battery life: > 100 hours

Housing: meets IP67 standards for waterproof and dustproof housing

Dimensions:

Meter: 7.5"L x 3.5"W x 1.75"H

(19.1 cm x 8.9 cm x 4.5 cm)

Boxed: 9.2"L x 8.5"W x 2.75"H

(23.3 cm x 21.6 cm x 7 cm)

Shipping weight: 1.3 lbs (0.6 kg)

